

MAYTAG

Commercial Dryer - 30 lb. PC2, MC2 & MN2, 50, 75 and 100 lb.

Installation/Operator's Manual

WARNING: For your safety the information in this manual must be followed to minimize the risk of fire or explosion or to prevent property damage, personal injury or death.

Do not store or use gasoline or other flammable vapor and liquids in the vicinity of this or any other appliance.

WHAT DO YOU DO IF YOU SMELL GAS

- * Do not try to light any appliance.
- * Do not touch any electrical switch; do not use any phone in your building.
- * Clear the room, building or area of all occupants.
- * Immediately call your gas supplier from a neighbor's phone. Follow the gas supplier's instructions.
- * If you cannot reach your gas supplier, call the fire department.

Installation and service must be performed by a qualified installer, service agency or the gas supplier.

MAYTAG

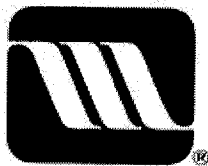

**RETAIN THESE INSTRUCTIONS IN A SAFE PLACE
FOR FUTURE REFERENCE**

Retain This Manual In A Safe Place For Future Reference

This product embodies advanced concepts in engineering, design, and safety. If this product is properly maintained, it will provide many years of safe, efficient, and trouble-free operation.

ONLY properly licensed technicians should service this equipment.

OBSERVE ALL SAFETY PRECAUTIONS displayed on the equipment or specified in the installation/operator's manual included with the dryer.

WARNING: UNDER NO CIRCUMSTANCES should the door switch or the heat circuit devices ever be disabled.

WARNING: The dryer *must never* be operated with any of the back guards, outer tops, or service panels removed. PERSONAL INJURY or FIRE COULD RESULT.

We have tried to make this manual as complete as possible and hope you will find it useful. Manufacturer reserves the right to make changes from time to time, without notice or obligation, in prices, specifications, colors, and material, and to change or discontinue models.

Important

For your convenience, log the following information:

DATE OF PURCHASE _____ MODEL NO. _____

DISTRIBUTORS NAME _____

Serial Number(s) _____

For replacement parts, contact the distributor from which the dryer was purchased or contact:

MAYTAG
403 West Fourth St North
Newton, Iowa 50208
(515) 792-7000

INSTRUCTIONS TO BE FOLLOWED IN THE EVENT THE USER SMELLS GAS MUST BE POSTED IN A PROMINENT LOCATION. THE INSTRUCTIONS TO BE POSTED SHALL BE OBTAINED FROM THE LOCAL GAS SUPPLIER.

IMPORTANT

YOU MUST DISCONNECT and LOCKOUT THE ELECTRIC SUPPLY and THE GAS SUPPLY or THE STEAM SUPPLY BEFORE ANY COVERS or GUARDS ARE REMOVED FROM THE MACHINE TO ALLOW ACCESS FOR CLEANING, ADJUSTING, INSTALLATION, or TESTING OF ANY EQUIPMENT per OSHA (Occupational Safety and Health Administration) STANDARDS.

CAUTION

LABEL ALL WIRES PRIOR TO DISCONNECTION WHEN SERVICING THE CONTROLS. WIRING ERRORS CAN CAUSE IMPROPER AND DANGEROUS OPERATION.

VERIFY PROPER OPERATION AFTER SERVICING.

CAUTION

DRYER(S) SHOULD NEVER BE LEFT UNATTENDED WHILE IN OPERATION.

WARNING

CHILDREN SHOULD NOT BE ALLOWED TO PLAY ON OR IN THE DRYER(S).

CHILDREN SHOULD BE SUPERVISED IF NEAR DRYER(S) IN OPERATION.

WARNING

The dryer must never be operated with any of the back guards, outer tops, or service panels removed. PERSONAL INJURY or FIRE COULD RESULT.

FOR YOUR SAFETY

DO NOT STORE OR USE GASOLINE OR OTHER FLAMMABLE VAPORS AND LIQUIDS IN THE VICINITY OF THIS OR ANY OTHER APPLIANCE.

DO NOT DRY MOP HEADS IN THE DRYER.

DO NOT USE DRYER IN THE PRESENCE OF DRY CLEANING FUMES.

IMPORTANT

PLEASE OBSERVE ALL SAFETY PRECAUTIONS displayed on the equipment and/or specified in the installation/operator's manual included with the dryer.

Dryer(s) **must not** be installed or stored in an area where it will be exposed to water and/or weather.

The wiring diagram for the dryer is located in the front electrical control box area of the dryer. In addition, there is also one enclosed in the last page of this booklet.

Table of Contents

SECTION I

IMPORTANT INFORMATION	2
A. RECEIVING and HANDLING	2
B. SAFETY PRECAUTIONS	2

SECTION II

SPECIFICATIONS	4
-----------------------------	---

SECTION III

INSTALLATION PROCEDURES	5
A. UNPACKING/SETTING UP	5
B. LOCATION OF THE DRYER	6
C. DRYER ENCLOSURE REQUIREMENTS	7
D. FRESH AIR SUPPLY	7
E. EXHAUST REQUIREMENTS	8
F. ELECTRICAL INFORMATION	9
G. GAS INFORMATION	11
H. PREPARATION FOR OPERATION	14
I. PREOPERATIONAL TESTS	14

SECTION IV

100 lb. INSTALLATION INFORMATION	16
A. LOCATION OF THE DRYER	16
B. FRESH AIR SUPPLY	18
C. EXHAUST REQUIREMENTS	19

SECTION V

OPERATING INSTRUCTIONS (30, 50, 75 & 100 lb. Models)	21
A. MECHANICAL COIN METER CONTROLS (non-computer)	21
B. MECHANICAL TIMER CONTROLS (non-computer)	22
C. OPL COMPUTER MODELS (non-computer)	23

SECTION VI

MAINTENANCE	25
A. CLEANING	25
B. ADJUSTMENTS	26
C. LUBRICATION	26

SECTION VII

PROCEDURE FOR FUNCTIONAL CHECK OF REPLACEMENT COMPONENTS	27
---	----

SECTION I

IMPORTANT INFORMATION

A. RECEIVING and HANDLING

The dryer is shipped in either a protective polyethylene cover and protective corners or is enclosed in a cardboard carton as a means of protection in transit. Upon delivery, the shipping carton and wooden skid **should be** visually inspected for shipping damage. If carton or wooden skid is damaged, inspect further.

Dryers Damaged in Shipment:

1. **ALL** dryers **should be** inspected upon receipt and before they are signed for.
2. If there is suspected damage or actual damage, the trucker's receipt **should be** so noted.
3. If the dryer is damaged beyond repair, it **should be** refused. Those dryers which were not damaged in a damaged shipment **should be** accepted, but the number received and the number refused **must be** noted on the receipt.
4. If you determine that the dryer was damaged after the trucker has left your location, you should call the delivering carrier's freight terminal immediately and file a claim. The freight company considers this concealed damage. This type of freight claim is very difficult to get paid and becomes extremely difficult when more than a day or two passes after the freight was delivered.
5. If you need further assistance in handling the situation, please contact the distributor.

IMPORTANT: THE DRYER <i>SHOULD BE</i> TRANSPORTED AND HANDLED IN AN UPRIGHT POSITION AT <u>ALL</u> TIMES.
--

B. SAFETY PRECAUTIONS

1. **DO NOT** store or use gasoline or other flammable vapors and liquids in the vicinity of this or any other appliance.
2. Purchaser/user should consult the local gas supplier for proper instructions to be followed in the event the user smells gas. The instructions **should be** posted in a prominent location.
3. Dryer **must be** exhausted to the outdoors.
4. Although this commercial dryer is a very versatile machine, there are some articles that, due to fabric composition or cleaning method, **should not** be dried in it.

WARNING: Dry only water-washed fabrics. *DO NOT* dry articles spotted or washed in dry cleaning solvents, a combustible detergent, or "ALL PURPOSE" cleaners.
FIRE OR EXPLOSION COULD RESULT.

WARNING: *DO NOT* dry rags or articles coated with gasoline, kerosene, paint, wax, oil, or grease.
FIRE OR EXPLOSION COULD RESULT.

WARNING: *DO NOT* dry mop heads. Contamination by wax or flammable solvents will create a fire hazard.

WARNING: *DO NOT* use heat for drying articles that contain plastic, foam, sponge rubber, or similarly textured rubber-like materials. Drying in a heated tumbler may damage plastics or rubber and also may be a fire hazard.

5. A program **should be** established for the inspection and cleaning of lint in the heating unit area, exhaust duct work, and inside the dryer. The frequency of inspection and cleaning can best be determined from experience at each location.

WARNING: The collection of lint in the burner area and exhaust duct work can create a potential fire hazard.

6. For personal safety, the dryer **must be** electrically grounded in accordance with local codes and/or the National Electric Code ANSI/NFPA NO. 70-LATEST EDITION.

NOTE: Failure to do so will VOID THE WARRANTY.

9. **UNDER NO CIRCUMSTANCES** should the dryer door switch or heat safety devices ever be disabled.

WARNING: PERSONAL INJURY or FIRE COULD RESULT.

8. This dryer is not to be used in the presence of dry cleaning solvents or fumes.
9. Remove articles from the dryer as soon as the drying cycle has been completed.

WARNING: Articles left in the dryer after the drying and cooling cycles have been completed **CAN CREATE A FIRE HAZARD.**

10. **READ and FOLLOW ALL CAUTION and DIRECTION LABELS ATTACHED TO THE DRYER.**

SECTION II

SPECIFICATIONS

	30 LB		50 LB		75 LB	
Maximum Capacity (Dry Weight)	30 lb.	13.6 kg	50 lb.	22.7 kg	75 lb.	34 kg
Tumbler Diameter	30"	76.2 c	32-3/4"	83.2 cm	37"	94 cm
Tumbler Depth	30"	76.2	37-1/2"	95.3 cm	36"	91.4 cm
Motor (Horsepower)	1/2	373 kw	3/4	560 kw	1	.746 kw
Door Opening	21-1/2"	54.61 cm	21-1/2"	54.61 cm	21-1/2"	54.61 cm
Dryers Per 20'/40' Container	12/28	12/28	10/20	10/20	10/20	10/20
Dryers Per 45'/48' Truck	30/32	30/32	24/26	24/26	24/24	24/24
Air Flow	600 cfm	17 cmm	600 cfm	17 cmm	1100 cfm	31.15 cmm
Approx. Weight (uncrated)	500#	211 kg	565#	256 kg	690#	313 kg
Approx. Shipping Weight	550#	234 kg	625#	284 kg	750#	340 kg
Gas Heat Input	90,000 btuh	22,680 kcal/hr	150,000btuh	37,800 kcal/hr	200,000 btuh	50,400 kcal/hr
Gas Inlet	1/2"	127 cm	1/2"	1.27 cm	3/4**	1.91 cm
Voltage / Amperage	115 volts / 15 amps		115 volts / 12 amps		115v / 13a 208v / 7a 230v / 6.5a / 15 amp	

* A minimum of 3/4" pipe must be supplied to each dryer.

DIM	30 LB		50 LB		75 LB	
A	72 *	182.88 cm	72	182.9 cm	75-1/8	190.82 cm
B	63	160.02 cm	63-1/2	161.29 cm	--	--
C	20-1/4	51.44 cm	20-1/4	51.44 cm	18-1/4	46.35 cm
D	62-1/2	158.75 cm	50-3/4	128.9 cm	--	--
E	6	15.24 cm	6	15.24 cm	8	20.3 cm
F	11-1/2	29.21 cm	13	32.0 cm	--	--
G	31-3/8	79.69 cm	34-1/4	87.0 cm	38-1/4	97.15 cm
H	41-7/8	106.36 cm	49	124.4 cm	48-1/2	123.2 cm
I			43-7/8	111.4 cm		
J	7-1/2	19.05 cm				--
K	--	--	--	--	31-13/16	80.8 cm
L	--	--	--	--	14	35.56 cm
M	--	--	--	--	5	12.7 cm
N	--	--	--	--	10	25.4 cm
O	--	--	--	--	7	17.78 cm

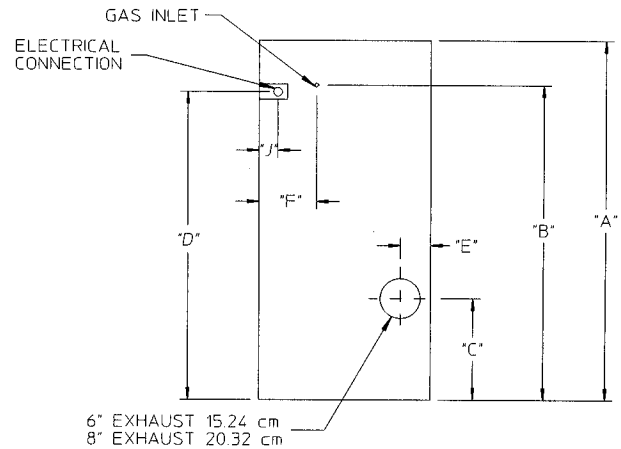

REAR VIEW

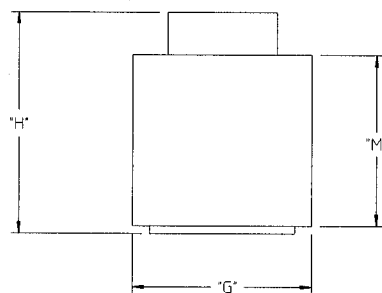

TOP VIEW

MAN3729

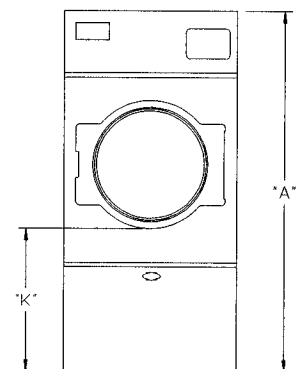

FRONT VIEW

SECTION III

INSTALLATION PROCEDURES

Installation **should be** performed by competent technicians in accordance with local and state codes. In the absence of these codes, the installation **must conform** to applicable AMERICAN NATIONAL STANDARDS:

ANSI.Z223.1-LATEST EDITION (National Fuel Gas Code)
and/or
ANSI/NFPA NO. 70-LATEST EDITION (National Electric Code)

A. UNPACKING/SETTING UP

Remove shipping carton, or polyethylene cover and protective shipping corners from dryer.

NOTE: The access keys for the control (service) door, and lint door are shipped in the dryer and ***should be*** removed and put in a safe place. Yet made accessible, because some will be needed throughout various phases in the installation of the unit. Non-coin dryers are equipped with dummy locks in both the lint and the control doors. These locks can be turned with a screw driver or other similar tool.

The dryer can be moved to its final location while still attached to the skid or with the skid removed. To unskid the dryer, locate and remove the four (4) bolts securing the base of the dryer to the wooden skid. Two (2) are located at the rear of the base, and two (2) are located in the lint chamber bottom. Once the bolts are removed, slide the dryer off the skid.

NOTE: 100 lb. ONLY: Once the bolts are off, remove the eight (8) nuts and bolts holding the skid together and take the skid apart. The dryer can now be removed from the skid.

With the skid removed, to make it easier to slide the dryer into its final position, slightly lower all leveling legs so that the dryer will slide on the legs instead of the base frame. The dryer is equipped with four (4) leveling legs, one at each corner of the drying base. Two (2) are located at the rear of the dryer base and two (2) are located in the lint chamber.

NOTE: 100 lb. ONLY: This unit does not have leveling legs. To level the dryer, place 4-inch square metal shims or other suitable material under the base pads.

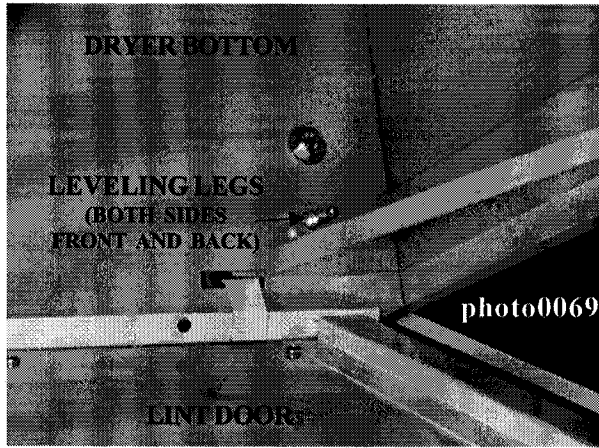

The tumblers of the 30, 50, and 75 lb. model dryers are supported during shipping by a wooden block. **Remove the block before starting the dryer.**

The lint coops of the 30, 50, 75, and 100 lb. model dryers are supported during shipping by a bracket. **Remove this bracket before starting the dryer.**

100 lb. Model ONLY - The V-belts are disconnected from the tumbler drive motor for shipping. Reconnect the belts before starting the dryer.

B. LOCATION OF THE DRYER

Before installing the dryer, be sure the location conforms to local codes and ordinances.

The dryer must be installed on a sound, level floor capable of supporting its weight. It is recommended that carpeting be removed from the floor area on which the dryer is to rest.

It is recommended that the rear of the dryer be positioned about two (2) feet away from the nearest obstruction (i.e., wall) for ease of installation, maintenance and service.

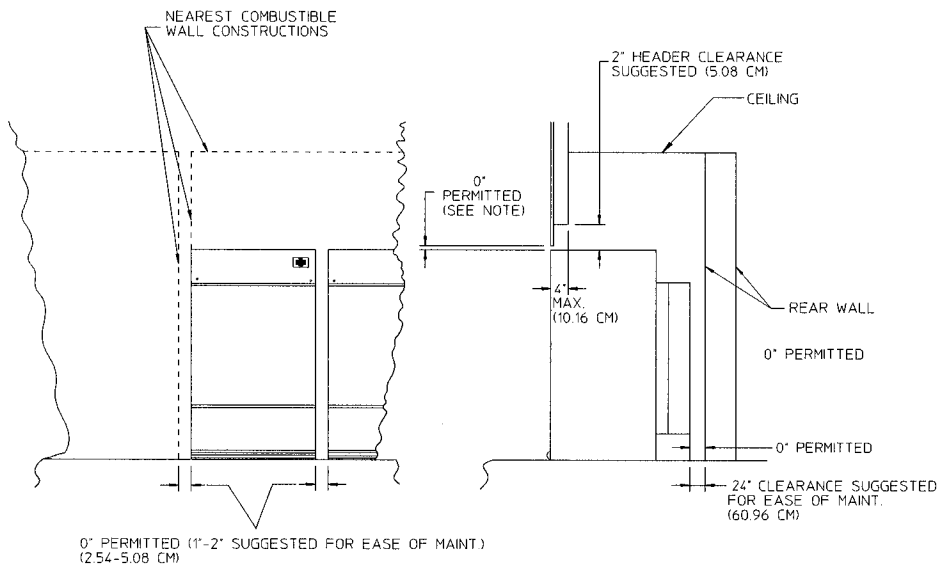

BONNET EXTENDS UP 1 3/4" ABOVE DRYER ON ALL MODELS

MAN3727

INSTALLATION: DRYER CLEARANCE TO ADJACENT WALL STRUCTURES.

C. DRYER ENCLOSURE REQUIREMENTS

Bulkheads and partitions **should be** made of noncombustible materials and **must be** located a minimum of 12 inches above the dryer outer top, except along the front of the dryer which may be closed in, if desired.

NOTE: Allowances *must be* made for opening the control door.

Dryers may be positioned side wall to side wall. However, allowances **should be** made for opening and closing of the control and lint doors. It is suggested that the dryer be positioned about two (2) feet away from the nearest rear obstruction for ease of installation, maintenance, and service. Refer to the previous illustration for details.

NOTE: Air considerations are important for proper and efficient operation.

D. FRESH AIR SUPPLY

For additional information pertaining to 100 lb. model see **page 18**.

30, 50, & 75 lb. Models: Air supply (make-up air) **must be** given careful consideration to assure proper performance of each dryer. An unrestricted source of air is necessary for each dryer. As a general rule, an unrestricted air entrance from the outdoors (atmosphere) of a minimum of one (1) sq. ft. is required for each dryer. If registers or louvers are installed over the openings, then the area **must be** increased. It is not necessary to have a separate make-up air opening for each dryer. Common make-up air openings are acceptable. However, they **must be** set-up in such a manner the make-up air is distributed equally to the dryers. For example, for a bank of eight (8) dryers, two (2) openings measuring 2' x 2' (4 square feet) is acceptable. Refer to the following illustration for details. For the 100 lb. model, see **page 18**.

Allowances **must be** made for remote or constricting passageways or where dryers are located at excessive altitudes or predominantly low-pressure areas.

IMPORTANT: Make-up air *must be* provided from a source free of dry cleaning solvent fumes. Make-up air that is contaminated by dry cleaning fumes will result in irreparable damage to motors and other dryer components.

NOTE: Component failure due to dry cleaning solvent fumes VOIDS THE WARRANTY.

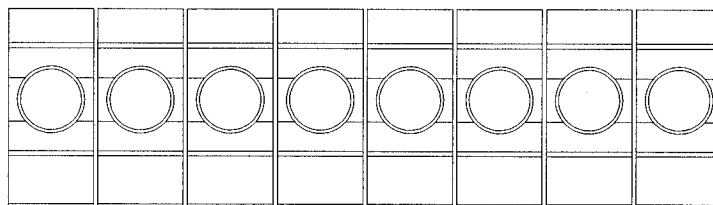
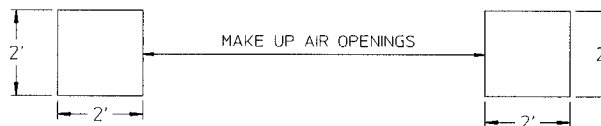

MAN3722

E. EXHAUST REQUIREMENTS

Exhaust duct work **should be designed and installed by a qualified technician**. Improperly sized duct work will create excessive back pressure which results in slow drying, increased use of energy, overheating of the dryer, and shutdown of the burner by the airflow (sail) switch, burner hi-limit, or lint chamber hi-heat protector thermostat. Refer to the following illustrations for details.

CAUTION: IMPROPERLY SIZED OR INSTALLED EXHAUST DUCT WORK CAN CREATE A POTENTIAL FIRE HAZARD.

MULTIPLE DRYER VENTING WITH AN "A" DIAMETER EXHAUST CONNECTIONS AT COMMON DUCT

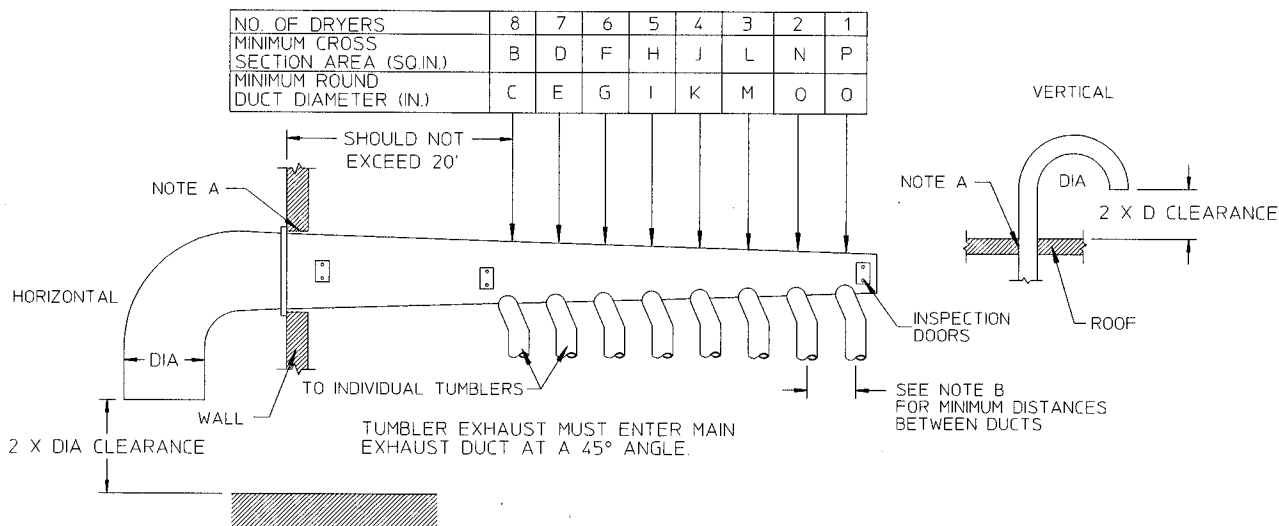

IMPORTANT: NO MORE THAN 8 DRYERS CAN BE CONNECTED TO ONE COMMON DUCT (VENT).

MAN3725

FORMULAS TO CALCULATE DUCTING CROSS SECTIONAL AREA

CROSS SECTIONAL AREA OF A ROUND DUCT = .785 x DIA²

CROSS SECTIONAL AREA OF A RECTANGULAR DUCT = WIDTH x HEIGHT

NOTE A: OPENING MUST BE TWO (2) INCHES LARGER THAN DUCT (ALL THE WAY AROUND). THE DUCT MUST BE CENTERED WITHIN THIS OPENING

NOTE B: 75 lbs.-38 1/4"

NOTE B: 50 lbs.-38 1/4", 30 lbs.-31 3/8"

75 lbs.

Dryer Exhaust Duct Size: 8"
Dryer Air Flow: 1,200 cfm

A	B	C	D	E	F	G	H	I	J	K	L	M	N	O	P	Q
8"	530	26	455	24	455	24	380	22	315	20	255	18	200	16	115	12

50 lbs.

Dryer Exhaust Duct Size: 8"
Dryer Air Flow: 600 cfm

A	B	C	D	E	F	G	H	I	J	K	L	M	N	O	P	Q
8"	380	22	315	20	315	20	255	18	200	16	155	14	115	12	80	10

F. ELECTRICAL INFORMATION

1. Electrical Requirements

It is your responsibility to have **ALL** electrical connections made by a properly licensed and competent electrician to assure that the electrical installation is adequate and conforms with local and state regulations or codes. In the absence of such codes, **ALL** electrical connections, materials, and workmanship **must conform** to the applicable requirements of the National Electric Code ANSI/NFPA NO.70-LATEST EDITION.

IMPORTANT: Failure to comply with these codes or ordinances, and/or the requirements stipulated in this manual, can result in **PERSONAL INJURY** or **COMPONENT FAILURE**.

NOTE: Component failure due to improper installation VOIDS THE WARRANTY.

It is recommended that a separate circuit serving each dryer **must be** provided. The dryer **must be** connected to copper wire **ONLY**. **DO NOT** use aluminum wire which could cause a fire hazard.

NOTE: The use of aluminum wire VOIDS THE WARRANTY.

2. Electrical Service Specifications

Model	Voltage	Phase	No. of Wires	Amp Draw Per Tumbler	Wire Size	Breaker Size Per Tumbler
30 lb.	115	1	2	9	#12	20 Amp.
50 lb.	115	1	2	12	#12	20 Amp.
75 lb.	115	1	2	14	#12	30 Amp.
100 lb.	230	3	3	7	#14	15 Amp.

IMPORTANT: The dryer **must be** connected to the electrical supply shown on the data label affixed to the dryer. In case of 208 or 230 volts, the supply voltage must match the electric service specs of the data label exactly. The voltages 208 and 230 are not the same. See the wire diagram located on the rear side of the control door.

3. Grounding

A ground (earth) connection **must be** provided and installed in accordance with state and local codes. In the absence of these codes, grounding **must conform** to applicable requirements of the National Electric Code ANSI/NFPA NO. 70-LATEST EDITION. The ground connection may be to a proven earth ground at the location service panel.

For added personal safety, when possible, it is suggested that a separate ground wire (no. 18 minimum) be connected from the ground connection of the dryer to a grounded cold water pipe. **DO NOT ground to a gas pipe.**

NOTE: For 100 lb. model, a no. 12 minimum separate ground wire *should be* used.

The grounded cold water pipe must have metal to metal connection all the way to electrical ground. If there are any non-metallic interruptions, such as, a meter, pump, plastic, rubber or other insulating connectors, they **must be** jumped with no. 4 copper wire and securely clamped to bare metal at both ends.

IMPORTANT: For personal safety and proper operation, the dryer *must be* grounded.

4. Electrical Connections

A wiring diagram is located on the back side of the control (service) door for connection data.

Single Phase Hookup

On the single-phase dryers, the electrical input connection is made to the three connection leads (L1, L2 or N and ground) extending out of the junction box located at the upper left rear of the dryer.

Single-Phase Electrical Connection Leads

Black	White	Green
+	-	
Positive	Neutral	Ground
(L1)	(L2)	(GND)

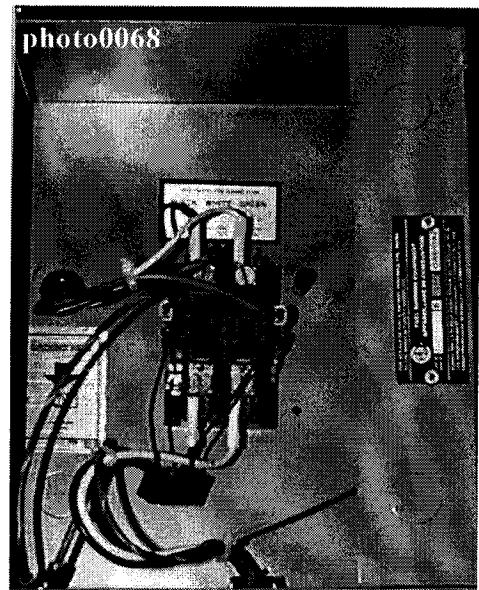
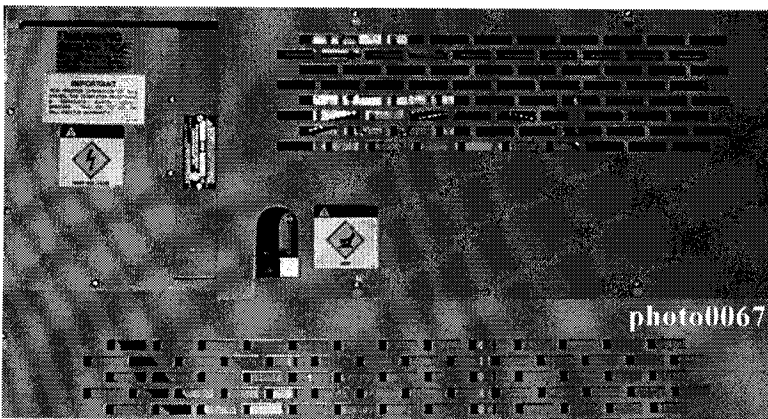

5. 3-Phase Wiring Connections

The only electrical input connections to the dryer are the 3-phase power leads (L1, L2, L3, N) and ground. Single-phase power for the control circuit and for any single-phase motors (if present) is done internally to the dryer. No single-phase input connection is required on a 3-phase dryer.

3-Phase Hookup

For dryers manufactured for operation at 3-phase, the electrical connections are made at the 3-pole contactor (relay) located in the service box at the rear, upper left corner of the dryer. To gain access to the service box and contactor, the service box cover **must be** removed. For models with a back guard, the back guard **must be** removed to gain access to the service box.

Providing local codes permit, power to the dryer can be made by the use of a flexible U.L. listed cord/pigtail (wire size **must conform** to the rating of the dryer), or the dryer can be hard wired directly to the service breaker. The power supply wiring may enter the dryer through the top back area at the outer top or relief **should be** used both where the wiring enters the dryer and the service box.

G. GAS INFORMATION

The dryer and its individual shut-off valve **must be** disconnected from the gas supply piping system during any pressure testing of that system at test pressures in excess of 1/2 psig (3.5 kPa).

The dryer **must be** isolated from the gas supply piping system by closing its individual manual shut-off valve during any pressure testing of the gas supply system at test pressures equal to or less than 1/2 psig (3.5 kPa).

1. Gas Supply

The gas dryer installation **must meet** the American National Standard, National Fuel Gas Code ANSI Z223.1-LATEST EDITION, as well as local codes and ordinances and **must be** done by a qualified technician.

GASVALVE

GASVALVE
SHUT-OFF

photo0065

NOTE: Undersized gas piping will result in ignition problems, slow drying, increased use of energy, and can create a safety hazard.

The dryer **must be** connected to the type of heat/gas indicated on the dryer data label located on the inside of the control door. If this information does not agree with the type of gas available, contact the distributor who sold the dryer or the manufacturer.

NOTE: Any burner changes or conversions *must be* made by a qualified technician.

The gas input ratings shown on the dryer data label are for elevations up to 2,000 feet, unless elevation requirements of over 2,000 feet were specified at the time the dryer order was placed with the distributor. The adjustment for dryers in the field for elevations over 2,000 feet are made by changing the burner orifices. If this adjustment is necessary, contact the distributor who sold the dryer.

NOTE: Any burner changes or conversions *must be* made by a qualified technician.

2. Technical Gas Data

a. Natural Gas

The natural gas supply pressure to the dryer **must be** between six (6) and 11 inches water column. If the pressure is too low, ignition failure and/or slow drying times may result. Excessively high supply pressure will result in erratic operation of the gas valve's internal pressure regulator. The pressure measured at the pressure tap on the body of the gas valve **must be** four (4) inches water column. This will make the manifold pressure 3-1/2 inches water column.

b. Liquid Propane (L.P.) Gas

Dryers made for use with L.P. gas have the gas valve pressure regulators blocked open so that the gas pressure **must be** regulated upstream of the dryer. The pressure measured at the gas valve body pressure tap **must be** 11 inches water column. This will make the manifold pressure 10 inches water column.

3. Piping Connections

The dryer is provided with a 1/2" N.P.T. models (3/4" N.P.T. for 75 and 100 lb. models) inlet pipe connection extending out the rear area or through the top of the dryer. For ease of servicing, the gas supply line of each dryer should have its own shut-off valve.

The size of the main gas supply line (header) will vary depending on the distance this supply line travels from the gas meter or in the case of L.P. gas, the supply tank), the amount of tees, other gas operated appliances, etc. Specific information regarding supply line size **should be** determined by the gas supplier.

NOTE: Undersized gas supply piping can create a low or inconsistent pressure which will result in erratic operation of the burner ignition system.

Consistent gas pressure is essential at **ALL** gas connections. It is recommended that a 3/4" pipe gas loop be installed in the supply line serving the bank of dryers. An in-line pressure regulator **must be** installed in the gas supply line (header) if (natural) gas line pressure exceeds 11 inches water column pressure. Refer to the following illustrations for details.

IMPORTANT: Water column pressure of four (4) inches for natural gas dryers and 11 inches for L.P. dryers is required at the gas valve pressure tap of each dryer for proper and safe operation. This will make the manifold pressure 3-1/2 inches water column for natural gas and 10 inches for L.P.

A 1/8" N.P.T. plugged tapping, accessible for a test gauge connection, **must be** installed in the main gas supply line immediately upstream of the dryer.

IMPORTANT: Pipe joint compounds that resist the action of natural gas and L.P. gas **must be** used.

WARNING: Test **ALL** connections for leaks by brushing on a soapy water solution (liquid detergent works well). **NEVER TEST FOR LEAKS WITH A FLAME!!!**

ALL components/materials **must conform** to National Fuel Gas Code specifications. It is important that gas pressure regulators meet applicable pressure requirements and gas meters be rated for the total amount of appliance BTU's being supplied.

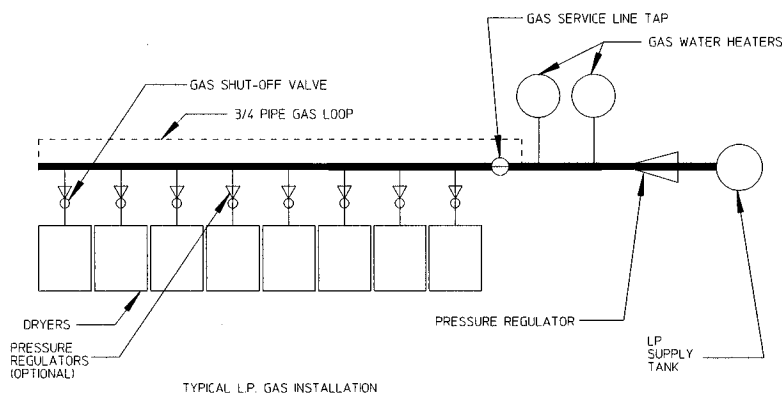
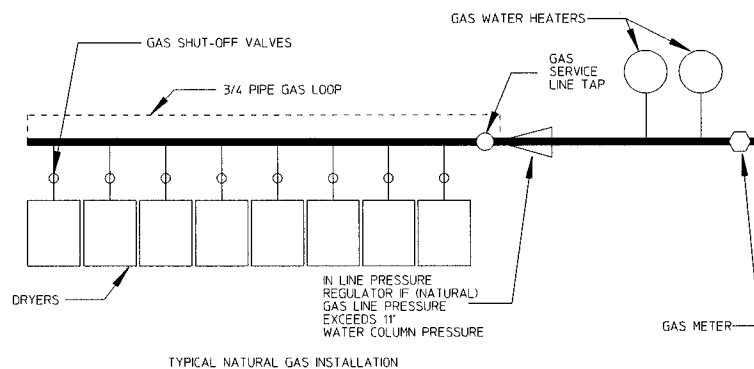

man0132

H. PREPARATION FOR OPERATION

The following items **should be** checked before attempting to operate the dryer:

1. Read and follow **ALL** "CAUTION," "WARNING," and "DIRECTION" labels attached to the dryer.
2. Check incoming supply voltage to be sure that it is the same as indicated on the dryer data label located on the rear side of the control door.
3. Check to assure that the dryer is connected to the type of heat/gas indicated on the dryer data label.
4. The sail switch damper assembly is installed and pre-adjusted at the factory prior to dryer shipment. However, the sail switch adjustment **must be** checked to assure that this important safety control is functioning.
5. Check bolts, nuts, screws, terminals, and fittings for security.
6. Be sure **ALL** gas shut-off valves are in the open position.
7. Be sure **ALL** back guard panels and service box covers (3-phase models Only) have been replaced.

NOTE: Make sure lint coop bracket has been removed. Make sure V-belts have been reconnected.

8. Check the lint door to assure that it is closed and secured in place.

IMPORTANT: If during installation the lint door safety chain was disconnected, it *must be* reconnected or personal injury may result.

9. Rotate the tumbler (drum) by hand to be sure it moves freely.

I. PREOPERATIONAL TESTS

ALL dryers are thoroughly tested and inspected before leaving the factory. However, a preoperational test **should be** performed before the dryer is publicly used. It is possible that adjustments have changed in transit.

1. Turn on electric power to dryer.
2. Refer to the operating instructions for starting your particular model dryers.
3. When a gas dryer is first started (during initial startup), it has a tendency not to ignite on the first ignition attempt. This is because the gas piping supply is filled with air, so it may take a few minutes for the air to be plugged from the lines.
4. Remove air from the gas line. Run the dryer about five (5) minutes. If the burner does not ignite during these five (5) minutes, turn the dryer off and wait a minute.

During this purging period, check to be sure **ALL** gas shut-off valves are open. If the dryer still fails to heat, refer to the troubleshooting guide.

5. Make a complete operational check of **ALL** the operating controls to assure that the timing is correct, temperature selection switches are functioning, etc.
6. Make a complete operational check of **ALL** safety-related circuits - door switch(es), hi-limit thermostat, sail switch, cycling thermostats, etc.
7. A gas pressure test **should be** taken at the gas valve pressure tap of each dryer to assure that the water column pressure is correct and consistent.

NOTE: Water column pressure requirements as measured at the gas valve pressure tap are:

Natural Gas	-	4 inches W.C.
L.P. Gas	-	11 inches W.C.

This will give a 3-1/2 inch water column manifold pressure for natural gas and a ten (10) inch for L.P.

8. If program changes are required, refer to your User's Manual.
9. The dryer **should be** operated through one complete cycle to assure that no further adjustments are necessary and that **ALL** components are functioning properly.

IMPORTANT: The dryer tumbler (basket/drum) is treated with a protective coating. We suggest tumbling old clothes or material in the basket using a mild detergent to remove coating.

10. On 3-phase models, check the electric service phase sequence. While the dryer is operating, check to see if the tumbler (basket/drum) is rotating in the clockwise direction (when viewed from the front). If so, the phasing is correct. If the tumbler rotates counterclockwise, the phasing is incorrect. Correct by reversing two (2) leads at connections L1, L2, or L3 of power supply to the dryer.

SECTION IV

100 lb. INSTALLATION INFORMATION

A. LOCATION OF THE DRYER

If more headroom is needed when moving the dryer into position, the top console may be removed. (Figure 1)

1. Disconnect the ground wire (A) at the rear of the dryer. (Figure 3)
2. Remove the six (6) nuts (B) holding the console to the base. (Figure 2)
3. Open the control door and disconnect the white 15-pin plug (C) located at the bottom of the control box. (Figures 2 and 3)
4. Lift the console off the base. (Figure 3)

To level the dryer, place 4-inch square metal shims (D) or other suitable material under the base pads. (Figure 3)

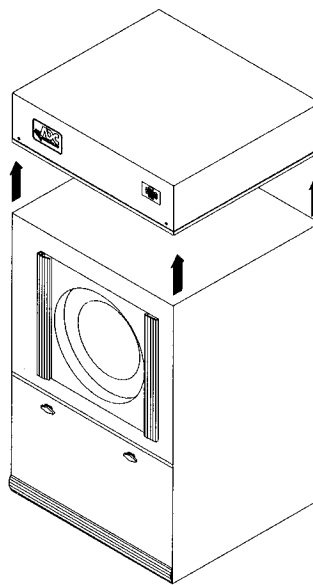

MAN0122

FRONT VIEW - Figure 1

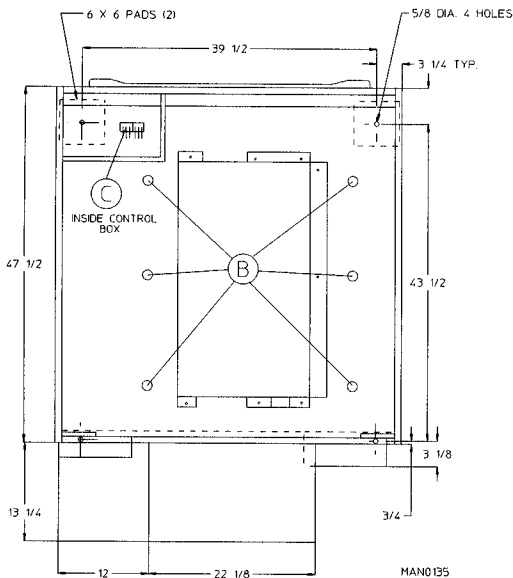

TOP (CUT AWAY VIEW) - Figure 2

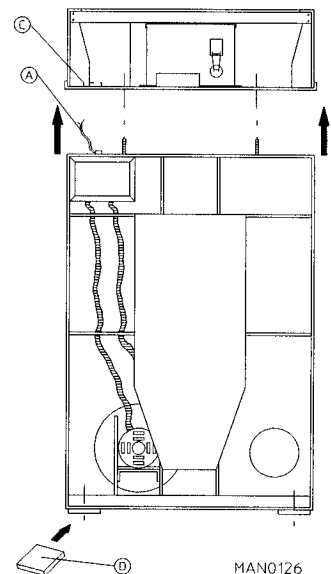

REAR VIEW - Figure 3

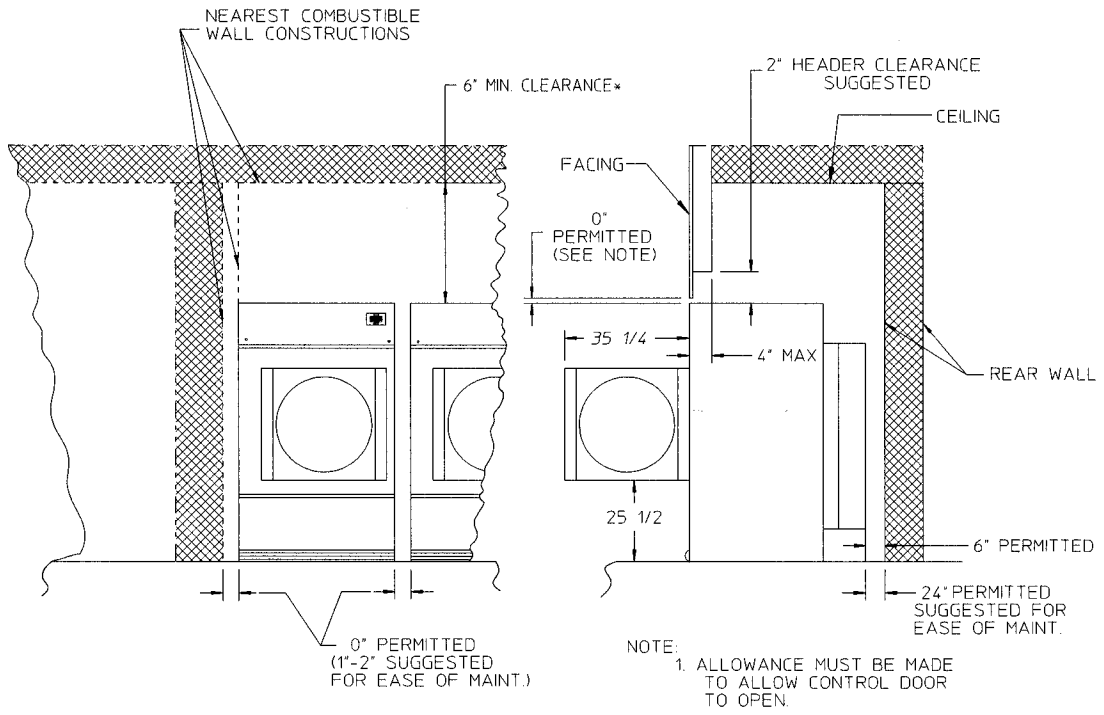

*12" OR MORE CLEARANCE IS SUGGESTED, ESPECIALLY IN CASES WHERE SPRINKLER HEADS ARE OVER THE DRYERS

MAN3724

INSTALLATION DRYER CLEARANCE TO ADJACENT WALL STRUCTURES.

Figure 4

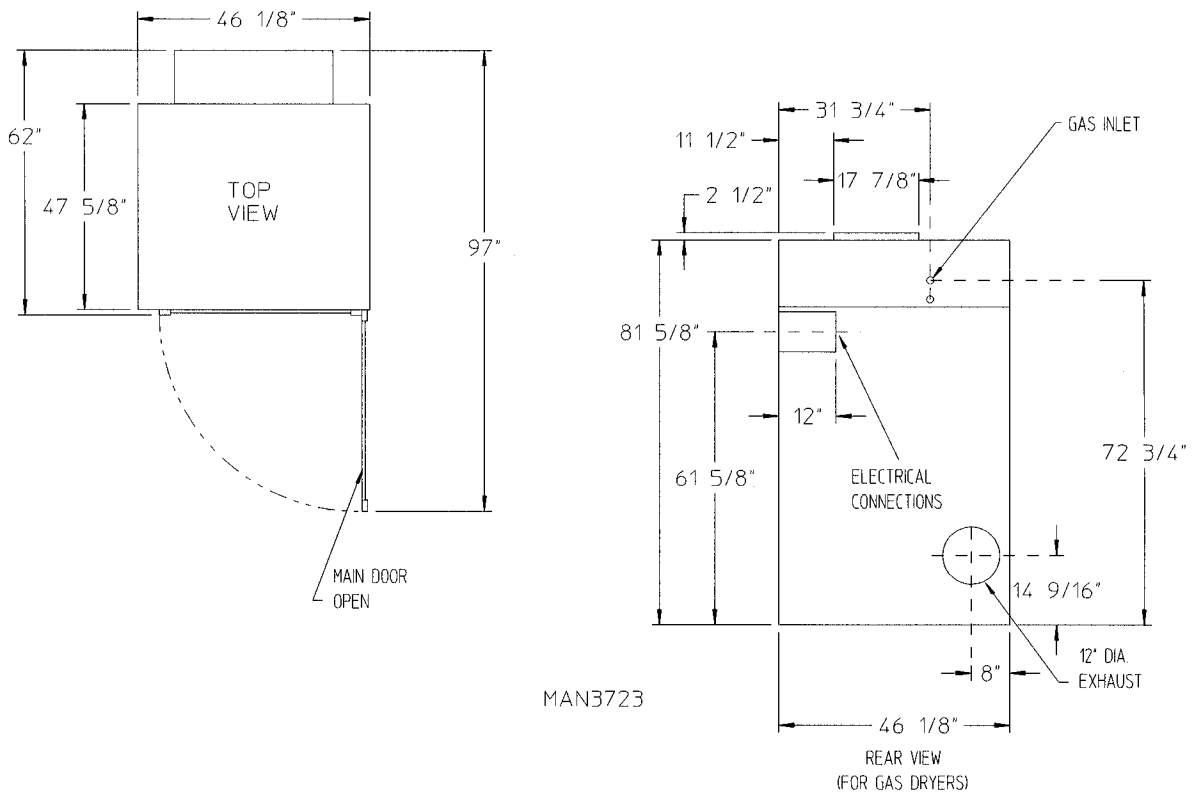

Figure 5

B. FRESH AIR SUPPLY

When the dryer is operating, it draws in room air, heats it, passed this air through the tumbler and exhausts it out of the building. Therefore, the room air **must be** continually replenished from the outdoors.

If the make-up air is inadequate, drying time and drying efficiency will be adversely affected. Ignition problems and sail switch "fluttering" problems on gas dryers may result and you also could have premature motor failure from overheating.

Air supply (make-up air) **must be** given careful consideration to assure proper performance of each dryer. An unrestricted source of air is necessary for each dryer. An air flow of 1750 CFM **must be** supplied. As a general rule, an unrestricted air entrance from the outdoors (atmosphere) of a minimum of three (3) square feet is required for each dryer.

If registers or louvers are installed over the openings, then the area **must be** increased.

It is not necessary to have a separate make-up air opening for each dryer. Common make-up air openings are acceptable. However, they **must be** set up in such a manner than the make-up air is distributed equally to the dryers.

Example: For a bank of six (6) gas dryers, two (2) openings measuring 3 feet by 3 feet (9 square feet) are acceptable. (Figure 6)

Allowances **must be** made for remote or constricting passageways or where dryers are located at excessive altitudes or predominantly low-pressure areas.

IMPORTANT: Make-up air **must be** provided from a source free of dry cleaning solvent fumes. Make-up air that is contaminated by dry cleaning fumes will result in irreparable damage to motors and other dryer components.

NOTE: Component failure due to dry cleaning solvent fumes VOIDS THE WARRANTY.

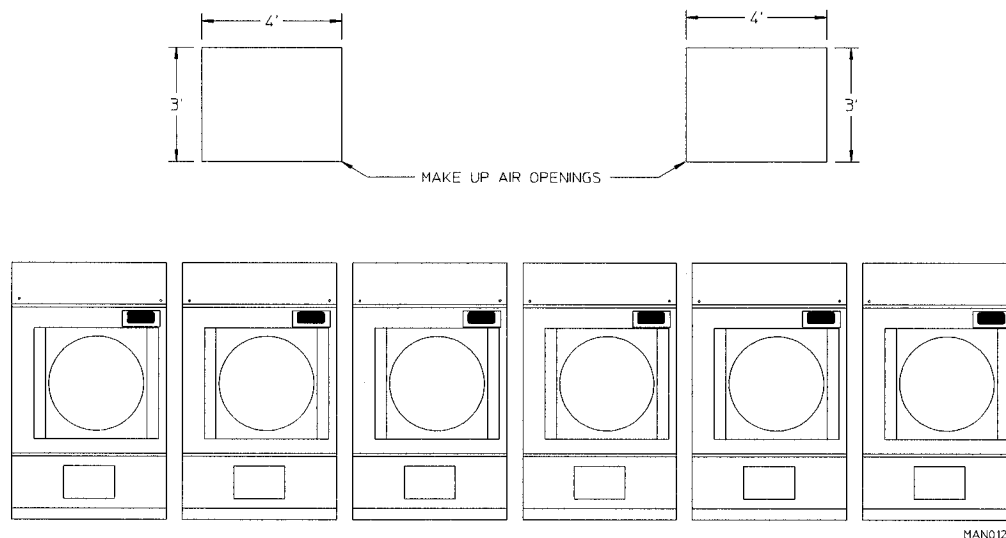

TYPICAL INSTALLATION SHOWING MAKE-UP AIR OPENINGS

Figure 6

C. EXHAUST REQUIREMENTS

Exhaust duct work **should be** designed and installed by a competent technician. Improperly sized duct work will create excessive back pressure which will result in slow drying, increased use of energy, and shutdown of the burner by the airflow (sail) switch, burner hi-limit or lint chamber hi-heat protector thermostat. Refer to Figure 7 for details

NO. OF DRYERS	6	5	4	3	2	1
MINIMUM CROSS SECTION AREA (SQ. IN.) FOR 12" DIA. DUCTS	670	560	450	340	230	115
MINIMUM ROUND DUCT DIA. (IN.) FOR 12" DIA. DUCTS	30	28	24	22	18	12
MINIMUM CROSS SECTION AREA (SQ. IN.) FOR 16" DIA. DUCTS	1230	1025	820	615	410	205
MINIMUM ROUND DUCT DIA. (IN.) FOR 16" DIA. DUCTS	40	36	32	28	24	16

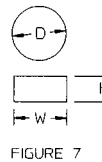
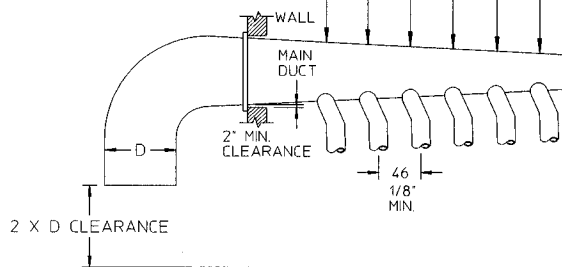

FIGURE 7

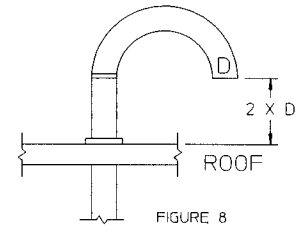

FIGURE 8

FORMULAS TO CALCULATE DUCTING CROSS SECTIONAL AREA

CROSS SECTIONAL AREA OF A ROUND DUCT = $785 \times D$ WHERE D-DIAMETER OF DUCT

CROSS SECTIONAL AREA OF A RECTANGULAR DUCT = $W \times H$ WHERE W -WIDTH AND H-HEIGHT.

MAN3726

Where possible, it is desirable to provide a separate exhaust air duct for each dryer. The duct for 100 lb. dryers **should be** 12 inches in diameter. The duct should go as directly as possible to the outside air. Avoid sharp 90 degree right angle turns in the ducting; use 30 degree or 45 degree angles instead. The radius of the elbows should preferably be 1-1/2 times the diameter of the duct. To protect the outside end of the duct from the weather, it may be bent downward as indicated in Figure 7. Leave at least twice the diameter of the duct clear between the duct opening and the nearest obstruction. If the exhaust duct goes through the roof, it may be protected from the weather by using a 180 degree turn to point the opening down as indicated in Figure 8. Allow at least twice the diameter of the duct as clearance from the nearest obstruction as indicated in Figure 8.

CAUTION: IMPROPERLY SIZED OR INSTALLED EXHAUST DUCT WORK CAN CREATE A POTENTIAL FIRE HAZARD.

NOTE: When a dryer is exhausted separately, it is recommended that a back draft damper be installed.

NOTE: When 100 lb. dryers are exhausted into a common exhaust line, each dryer *must be* supplied with a back draft damper.

Do not use screens or caps on the out side opening of the exhaust duct. The ducting **should be** smooth inside with no projections from sheet metal screws or other obstructions which will collect lint. When adding ducts, the duct to be added should overlap the duct to which it is to be connected. Provide inspection doors for periodic clean-out of lint from the main duct.

If it is not feasible to provide separate exhaust ducts for each dryer, ducts from the individual dryers may be channeled into a common main duct. Each 100 lb. dryer **must be** provided with a back draft damper. The individual ducts should enter the bottom or side of the main duct at an angle not more than 45 degrees and **should be** spaced at least 46-1/8 inches apart. (Figure 7) The main duct **should be** tapered with the diameter increasing before each individual duct is added.

On 100 lb. dryers, the minimum increase in cross section area **should be** 115 square inches for each 12 inch duct added and 205 square inches for each 16 inch duct added. Where rectangular main ducting is used, the areas shown **should be** increased 10 square inches and the ratio of the duct width to depth **should not be** greater than 3-1/2 to one. Figure 7 shows the minimum cross-section areas of the main duct for either 12 inch or 16 inch dryer ducts. These figures **should be** increased if the main duct is unusually long (20 feet or over) or has numerous elbows in it.

Inadequate exhaust facilities may cause high temperature limit switches or air flow switches to shut off the dryers. **DO NOT** disable the switches, which are provided for your safety. Instead, investigate the exhaust ducting. Any obstruction or air flow friction due to numerous elbows/fittings in the ducting will slow the passage of air through the system with resulting inefficiency and potential fire hazard.

SECTION V

OPERATING INSTRUCTIONS

30, 50, 75 & 100 lb. Models

A. MECHANICAL COIN METER CONTROLS (non-computer)

1. The controls of a coin-metered model dryer consist of:

Component	Function
Coin Meter	Permits the dryer to be started after the insertion of coins. The meter also controls the timing of the drying and cooling cycles.
Heater Selector Switch	Controls temperature of a drying cycle.
"Push to Start" button	Safety Device which must be manually "pressed" to start the dryer. Whenever the dryer is stopped by opening the main door during a cycle, the "Push to Start" button must be pressed to restart the dryer.
Indicator Light	Lights to indicate that the dryer is in the drying or cooling cycle.

2. Operating Sequence

- a. Insert coin. Rotate knob fully clockwise and release after coin is accepted.
- b. Make temperature selection in accordance with the type of material being dried.
- c. To start unit, press "Push to Start" button.

NOTE: Main door must be closed.

- d. The dryer will start. The heat circuit activates.
- e. During operation, the heat circuits will continue to be active until the thermostat controlling the "temperature selected" is satisfied and opens. The dryer will continue to operate under these conditions until the dryer enters the cool-down cycle or until the completion of metered time.

Time can be accumulated at any time by the insertion of more coins. Cool-down time is not accumulative. The dryer can be stopped at any time by opening the main door. While the door is open, the meter will continue to count time. Continuation of the cycle will only resume after the door is closed and the "Push to Start" button is again depressed.

B. MECHANICAL TIMER CONTROLS (non-computer)

1. The controls of a timer model dryer consist of:

Component	Function
Drying Time	Permits the dryer to run in the heating mode for a maximum time of 60 minutes.
Cool-Down Timer	Permits the dryer to run in the cool-down mode for a maximum of 15 minutes. Cool-down time starts at the conclusion of the drying time.
Heat Selector Switch	Controls the temperature during the drying cycle. Selections available are high temp., low temp., and permanent press.
"Push to Start" button	Safety Device which must be manually "pressed" to start the dryer. Whenever the dryer is stopped by opening the main door during a cycle, the "Push to Start" button must be pressed to restart the dryer.
Indicator Light	Lights to indicate that the dryer is in the drying or cooling cycle.

2. Operating Sequence

- a. Turn drying timer knob to desired drying time. Turn cool-down timer knob to desired cool-down time.
- b. Make temperature selection in accordance with the type of material being dried.
- c. To start unit, press "Push to Start" button.

NOTE: Main door *must be* closed.

- d. The dryer will start and the heat circuit will activate. The indicator light will come on.
- e. The heat will come on and stay on until the tumbler reaches the temperature setting of the selected thermostat. The thermostat will open shutting off the heat. As the tumbler temperature cools, the thermostat will reclose, turning on the heat. The dryer will operate in this manner for the duration of the drying time. At the completion of the drying time, the cool-down time will start. The dryer will run without heat for the duration of the cool-down time.

C. OPL COMPUTER MODELS (non-computer)

NOTE: The programs have been pre-set at the factory, for changes in the program consult the User's Manual or contact the distributor.

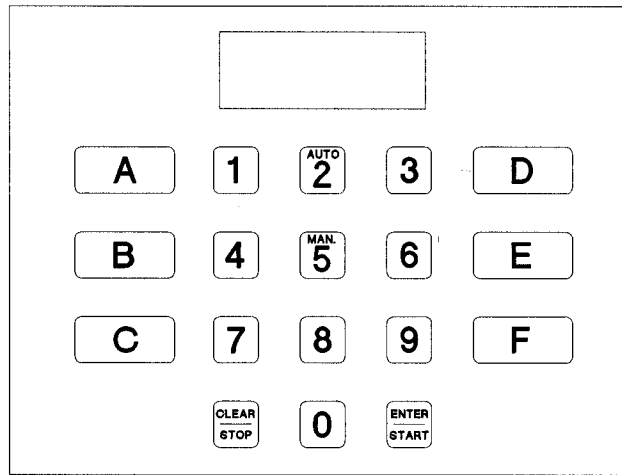

MAN3728

Manually Operated Timed Mode

1. When turning on power, or when no cycle is in progress, the L.E.D. display will read "FILL".
2. Press key number 5.
3. Select cycle drying time. Display will read "Ld--". Enter the drying time desired in the two blank spaces. Press enter/start key.
4. Select cycle cool down time. Display will read "LC--". Enter the cool down time desired, in the two blank spaces. Press enter/start key.
5. Select cycle drying temperature. Display will read "F---". Enter the drying temperature desired in the three blank spaces. Press enter/start key.
6. (For reversing dryers in select reverse mode only). Display will read "Sr--". Press enter/start to begin a reversing cycle and 0 to begin a non-reversing cycle.
7. Upon completion of drying and cooling cycles, the tone will sound and the display will read "donE" at which time the dryer will shut off.

a. NOTE: If the anti-wrinkle program is active, the display will remain reading "donE", and the computer will proceed through the anti-wrinkle program until the maximum Guard On Time has expired or until the door is opened, whichever comes first. The display will read "FILL".

b. NOTE: If the anti-wrinkle program is not active or in use, the display will read "donE" until the door is opened.

Manually Operated Automatic Mode

1. When turning on power, or when no cycle is in progress, the L.E.D. display will read "FILL".
2. Press key number 2.
3. Select cycle drying temperature. Display will read "F---". Enter the drying temperature required in the three blank spaces. Press enter/start key.
4. Select number of dryness levels. Display will read "d---". Enter dryness levels required in the three blank spaces. Press enter/start key.
5. (For reversing dryers in select reverse mode only). Display will read "Sr--". Press enter/start to begin a reversing cycle and 0 to begin a non-reversing cycle.
6. Once the pre-programmed drying time and cool down period have been reached, the tone will sound and the display will have read "donE", at which time the dryer will shut off.

a. NOTE: If the anti-wrinkle program is active, the display will continue to read "donE", and the computer will proceed through the anti-wrinkle program until the maximum Guard On Time has expired or until the door is opened, whichever, comes first. The display will read "FILL".

b. NOTE: If the anti-wrinkle program is not active or in use, the display will read "donE" until the door is opened.

Pre-Programmed Cycles

ALL programming for the pre-programmed cycles is already complete. Simply press the letter on the keyboard corresponding to the cycle desired (A through F) and the cycle will begin.

These pre-programmed cycles are set in A, B, and C. Keys D, E, and F are manually loaded cycles. See the User's Manual for further detail.

NOTE: The anti-wrinkle program will operate identical to manually entered programs.

SECTION VI

MAINTENANCE

A. CLEANING

A program and/or schedule **should be** established for periodic inspection, cleaning, and removal of lint from various areas of the dryer, as well as throughout the duct work system. The frequency of cleaning can best be determined from experience at each location.

Maximum operating efficiency is dependent upon proper air circulation. The accumulation of lint can restrict this air flow. If the guidelines in this section are met, a Maytag dryer will provide many years of efficient, troublefree and ... most importantly ... safe operation.

WARNING: LINT FROM MOST FABRICS IS HIGHLY COMBUSTIBLE. THE ACCUMULATION OF LINT CAN CREATE A POTENTIAL FIRE HAZARD. KEEP DRYER AREA CLEAR AND FREE FROM COMBUSTIBLE MATERIALS, GASOLINE and OTHER FLAMMABLE VAPORS or LIQUIDS.

Suggested Interval

Function

Daily

Clean lint from the lint screen. Inspect lint screen and replace if torn.

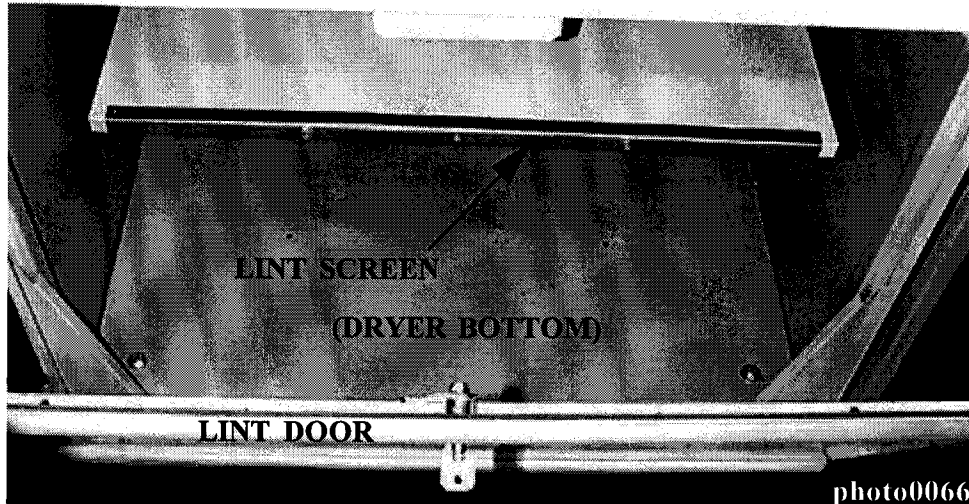

Weekly
90 Days

Clean any lint accumulation from the floors and walls of the lint chamber.

Remove lint accumulation from lint chamber, thermostats and sensors.

WARNING: TO AVOID THE HAZARD OR ELECTRICAL SHOCK, DISCONTINUE ELECTRICAL SUPPLY TO THE DRYER.

90 Days

On 100 lb. models, remove lint from the motor air vents and surrounding area.

IMPORTANT: Lint accumulation will restrict internal motor air flow, causing overheating and irreparable motor damage. Motor failure due to lint accumulation, **WILL VOID THE MANUFACTURER'S WARRANTY.**

Remove lint accumulation from around the openings in the dryer's back panels.

120 Days

Remove lint from gas burner area with a dusting brush to vacuum cleaner attachment. Remove any lint accumulation from between the inner and outer firing chambers of the gas burner.

6 Months

Inspect and remove lint accumulation in customer furnished exhaust duct work system and from the dryer's internal exhaust ducting, including the 3" diameter flex duct.

IMPORTANT: The accumulation of lint in the exhaust duct work can create a potential fire hazard.

6 Months

Inspect and remove lint accumulation from the dryer exhaust back draft damper.

NOTE: On ALL models excluding the 100 lb., a back draft damper that is sticking partially closed can result in slow drying and shutdown of the heat circuit safety switches or thermostats.

As Required

In the cleaning and care of the cabinet, avoid using harsh abrasives. A product intended for the cleaning of appliances is recommended.

B. ADJUSTMENTS

Suggested Interval

Function

7 Days After Installation and Every 6 Months

Inspect bolts, nuts, screws, non-permanent gas connections (unions, orifices, etc.), electrical terminals and grounding connections.

6 Months

Motor and drive belts **should be** examined. Cracked or seriously frayed belts **should be** replaced. Tighten loose belts when necessary and check belt alignment.

6 Months

Complete operational check of controls and valves.

6 Months

Complete operational check of ALL safety devices (door switches, sail switch, burner and lint chamber thermostats).

C. LUBRICATION

The motor bearings, idler bearings, and tumbler bearings are permanently lubricated. NO LUBRICATION IS NECESSARY.

SECTION VII

PROCEDURE FOR FUNCTIONAL CHECK OF REPLACEMENT COMPONENTS

1. Microprocessor (computer) Board

- a. Upon completing installation of the replacement microprocessor (computer) board, reestablish power to the dryer.
- b. Start the drying cycle.
- c. Verify that the motor(s) and the heat indicator dots, in the microprocessor (computer) L.E.D. display are on. (Refer to the illustration below.)

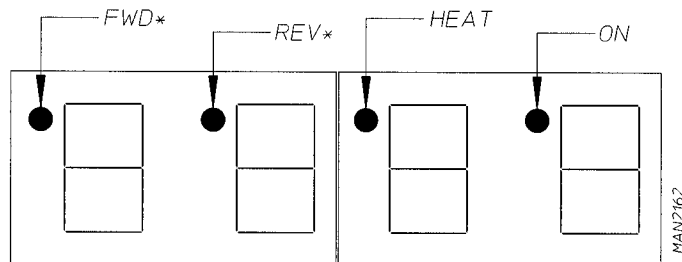

*OPL (NON-COIN) REVERSING MODELS ONLY.

- d. Verify that motor(s) heat, and door indicator lights on the back side of the microprocessor (computer) board are lit. (Refer to illustration below.)
- e. Open main door. The dryer **must stop** and **ALL** output indicator lights on the back side of the microprocessor (computer) board **must go out**.
- f. Try to restart the dryer with the main door open.

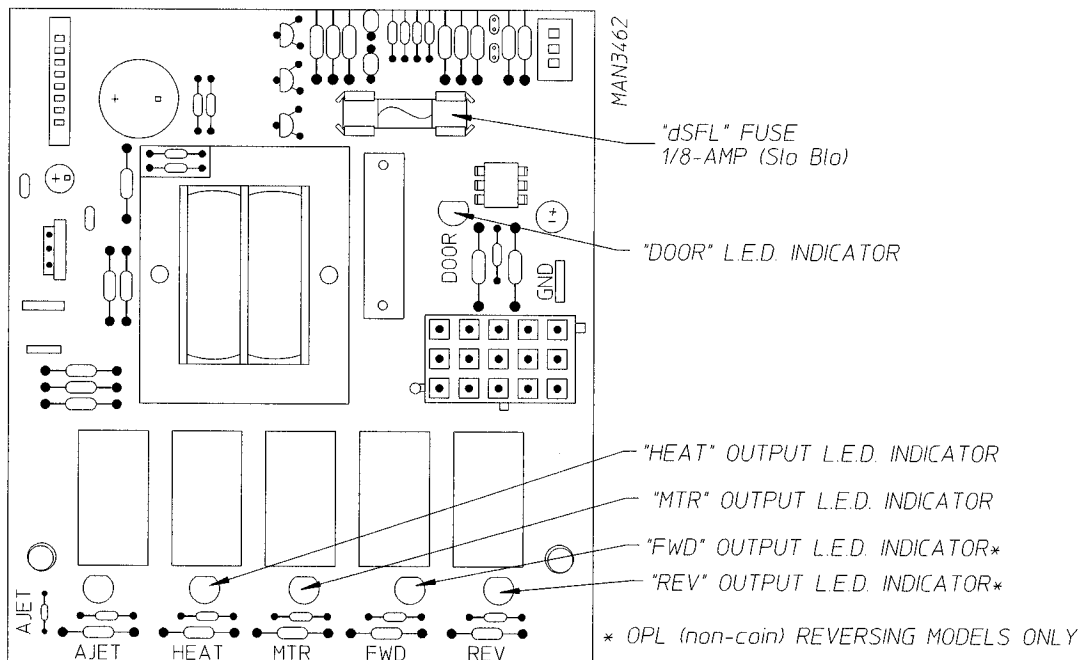

- g. The microprocessor (computer) board's L.E.D. display **must read "DOOR."**
- h. Close the main door and restart the dryer.
- i. Functional check of microprocessor (computer) board is complete.

2. Direct Spark Ignition (DSI) System

- a. Upon completing installation of the replacement Direct Spark Ignition (DSI) module, reestablish power to the dryer.
- b. Start the drying cycle.
- c. The ignition (DSI) module's L.E.D. indicator will light "red" for up to approximately 1.5 seconds (prepurge time).
- d. The module's indicator light will then turn "green". The gas valve will be energized and the ignitor probe will spark for approximately 8 seconds. The burner flame should now be established.
- e. With the burner flame on, remove the flame sensor wire from the FS terminal of the DSI module.
- f. The burner flame **must shut off** and the ignition module **must lock out** with the DSI module's indicator light "red".
- g. Stop the drying cycle, with the flame sensor wire still removed, restart the drying cycle.
- h. The ignition module **must proceed** through the prepurge, with the indicator light "red", the ignition trial time of approximately 8 seconds, with the indicator light "green", and then proceed to lock out with the indicator light "red".

- i. Functional check of the Direct Spark Ignition (DSI) Module is complete.

- 1) Replace the flame sensor wire from the FS terminal to the DSI module.

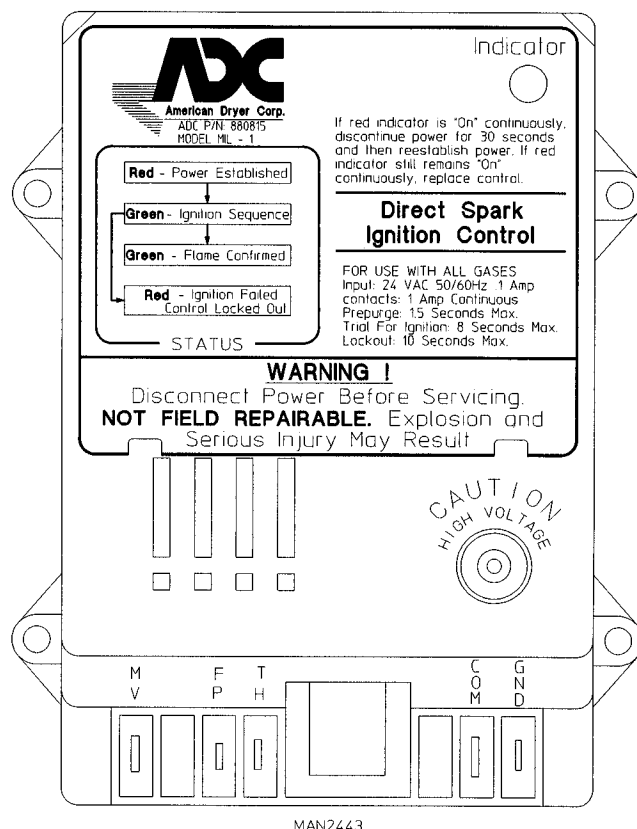

CAUTION

LABEL ALL WIRES PRIOR TO DISCONNECT WHEN SERVICING THE COMPUTER BOARD AND THE IGNITION MODULE. WIRING ERRORS CAN CAUSE IMPROPER AND DANGEROUS OPERATION.

Part No. 113033 1 - 01/30/98-100 2 - 06/19/98-100 3 - 07/31/98-250
4 - 12/23/98-250

