

GB

English

TCD970

First time you turn on your dryer you must select your preferred language see page 6

Contents

Important information, 2-3

Installation, 4

- Where to put your dryer
- Ventilation
- Electrical connection
- Before you start using your dryer

Dryer description, 5

- To open the door
- The features
- Control panel

The Display, 6-8

Start and programmes, 8-11

- Choosing a programme
- Special programmes
- Programme option modifiers
- Table of programmes
- The controls

Laundry, 12-13

- Sorting your laundry
- Wash care labels
- Special clothing items
- Drying times

Warnings and Suggestions, 14

- General safety
- Disposal
- Saving energy and respecting the environment

Maintenance and Care, 15

- Switching off the electricity
- Cleaning the filter after each cycle
- Empty the water container after each cycle
- Check the drum after each cycle
- Cleaning the condenser unit
- Cleaning the dryer

Troubleshooting, 16

Service, 17

- Spare parts

! Keep this instruction booklet on hand in order to refer to it when necessary. Take it with you when you move, and should you sell this appliance or pass it on to another party, make sure that this booklet is supplied along with the dryer so that the new owner may be informed about warnings and suggestions on how the appliance works.

! Read these instructions carefully; the following pages contain important information on installation and suggestions on how the appliance works.

 **Hotpoint**

GB

Important Information

Installation

Description

The Display

Start and Programmes

Laundry

Warnings and Suggestions

Maintenance and Care

Troubleshooting

Service

Important Information

GB

For your Condenser dryer to operate efficiently, you must follow the regular maintenance schedule shown below:

Fluff Filter...

! You MUST clean the fluff filter after EVERY drying cycle.

STEP 1.

Open the door of your dryer.



STEP 2.

Pull out the filter (using the two finger grips).

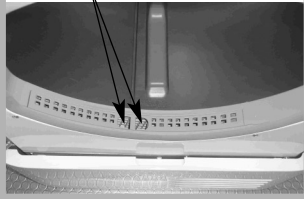

STEP 3.

Clean any fluff deposits from the filter mesh.

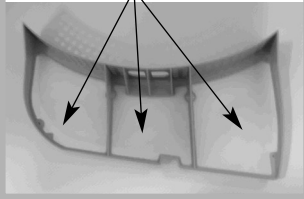

STEP 4.

Refit the filter - NEVER run the dryer without the filter in position.



! Failure to clean the filter after EVERY drying cycle will affect the drying performance of your machine.

- It will take longer to dry and as a result will use more electricity during drying.

Water Container...

! You MUST empty the water container after EVERY drying cycle.

STEP 1.

Pull the water container towards you and remove it fully from the dryer.



STEP 2.

Empty all the water collected in the water container.

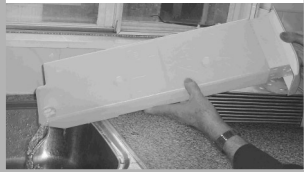

STEP 3.

Refit the water container, ensuring that it is pushed fully back into position.



! The 'Empty Water' message reminds you to empty the water container at the start and at the end of each programme.



! Failure to empty the water container will result in:

- The machine will stop heating (so the load may still be wet at the end of the drying cycle).
- The 'Empty Water' message will tell you that the water container is full.

Priming the Water Collection System

When your dryer is new, the water container will not collect water until the system is primed... this will take 1 or 2 drying cycles. Once primed it will collect water during every drying cycle.

Important Information



Condenser Unit...

! You MUST clean the fluff from the condenser EVERY month.

STEP 1.

Open the condenser cover - hold the handle and pull towards you.

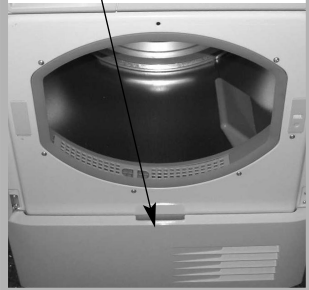

STEP 2.

Remove the condenser by rotating the 3 clips then pulling the condenser towards you. (There may be some water in the tubes, this is normal).

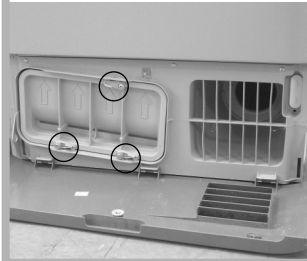

STEP 3.

Flush the condenser, from the rear with water, to remove any fluff deposits.

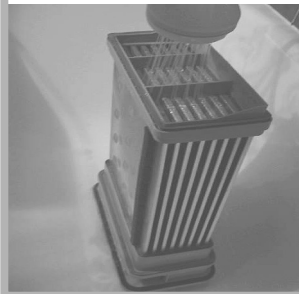

STEP 4.

Refit the condenser unit - ensure that the unit is pushed in fully, all 3 clips are re-secured and the positioning arrows on the front of the condenser are pointing upwards.

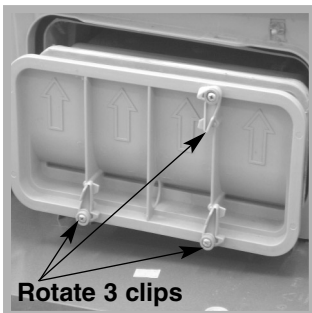
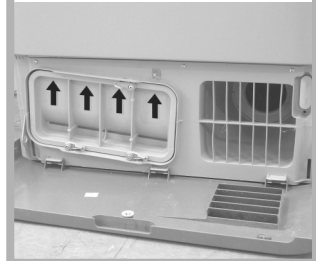

- Check that:
 - The positioning arrows are pointing upwards.
 - The 3 clips are re-secured back into their 'lock' position.

! Failure to clean the condenser could cause premature failure of your dryer.

GB

Important Information

Installation

Description

The Display

Start and Programmes

Laundry

Warnings and Suggestions

Maintenance and Care

Troubleshooting

Service

Installation

GB

Where to put your dryer

- Place your dryer at a distance from gas ranges, stoves, heaters, or cook tops because flames can damage the appliance.

Minimum gap 10mm

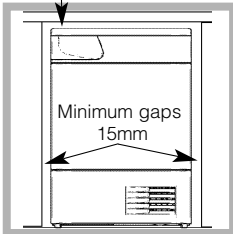

- If you are going to install the appliance under a work counter, be sure to leave a 10mm space between the top and any other objects on or above the machine and a 15mm space between the sides and lateral furnishings or walls. This is to ensure

proper air circulation. Make sure that the back vents are not obstructed.

Ventilation

When the dryer is in use, there has to be adequate ventilation. Make sure you put your dryer in an environment that is not damp and has proper air circulation throughout. Airflow around the dryer is essential to condense the water produced during the washing, the dryer will not operate efficiently in an enclosed space or cupboard.

! We do not recommend that the dryer is installed in a cupboard but the dryer must never be installed behind a lockable door, a sliding door or a door with a hinge on the opposite side to that of the dryer door.

! If using the dryer in a small or cold room some condensation could be experienced.

Door Reversal Instructions

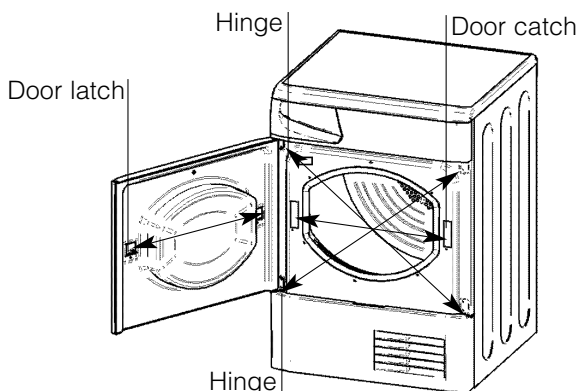

The door of your dryer is reversible and can easily be changed. Exchange diagonally hinge brackets and blanking screws. Exchange door latch and catch with their opposite blanking plates (*see diagram above*).

Water drain

If your dryer is installed next to a drain the water can be plumbed into this drain. This does away with the need to empty the water container. If the dryer is stacked onto or installed next to a washing machine it can share the same drain. The height of the drain must be less than 3' (1m) from the bottom of the dryer.



Remove the existing clip and hose from position shown (*see diagram*).

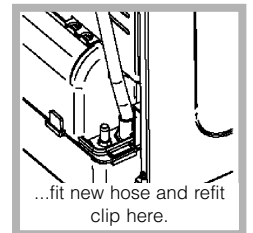

Fit a suitable length of hose to the new location shown (*see diagram*) and refit clip.

! Make sure that the hose is not squashed or kinked when the dryer is in its final location.

Electrical connections

Make sure of the following before you insert the plug into the the electrical socket:

- The socket must be grounded.
- The socket must be able to sustain the machines maximum power, which is indicated on the rating label (*see Dryer Description*).
- Power voltage must be within the values indicated on the rating label (*see Dryer Description*).
- The socket must be compatible with the dryers plug. Should this not be the case, replace the plug or the socket.

! The dryer must not be installed outdoors, even if the space is sheltered. It can be very dangerous if it is exposed to rain or storms.

! Once installed, the dryers electrical wire and plug must be within easy reach.

! Do not use extension cords.

! The power cord must not be bent or squashed.

! The power cord supplied should be checked periodically and replaced by a cord specially prepared for this dryer and fitted only by authorised technicians (*see Service*). New or longer power cords are supplied at an extra charge by authorised dealers.

! The manufacturer denies any responsibility should any of these rules not be followed.

! If in doubt about any of the above consult a qualified electrician.

Before you start using your dryer

Once you have installed your dryer and before you use it, clean the inside of the drum to remove any dust that could have accumulated during transport.

Dryer Description

To open the door

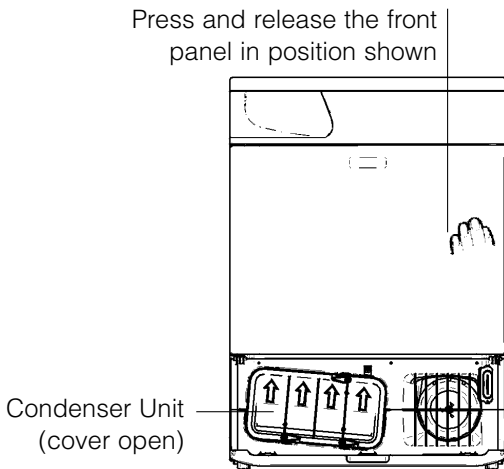

The features

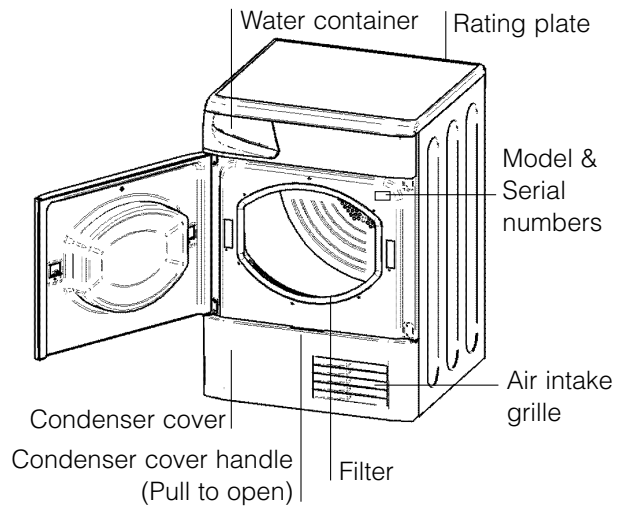

Control panel

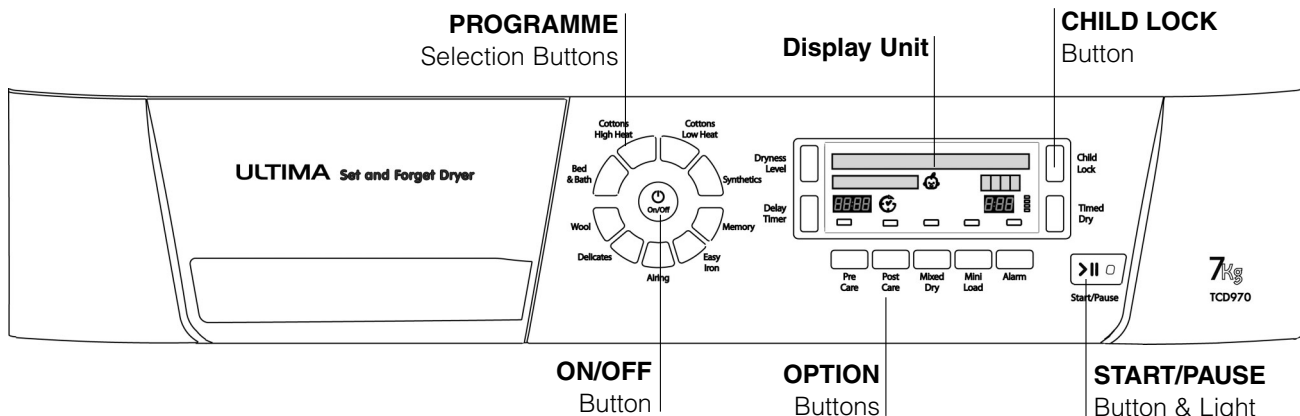

The **ON/OFF** button/light : If the dryer is running and this button is pressed, the dryer is turned off. Press again, the dryer restarts.

The **PROGRAMME** selection buttons set the programme: press the button corresponding to the programme you want to select (*see Start and Programmes*).

The **OPTION** buttons/indicators: these buttons select available options for your selected programme (*see The Controls*). The indicators on the display unit next to the buttons light to show that the option has been selected.

The **START/PAUSE** button/light starts a selected programme. When you press this button there will be one beep and the display will show **PAUSED**. When a programme is running, holding this button in pauses the programme and stops the dryer. The light is green when the programme is running, flashing amber if the programme has been paused or flashing green if on standby waiting to start a programme (*see Start and Programmes*).

The **Display Unit** gives warnings and information about the programme (*see next page*).

The **CHILD LOCK** button/icon : Press and hold this button after selecting your programme and any options, this prevents the programme settings from being changed, the display will briefly show **LOCKED**. When the icon is lit, the other buttons are disabled. Hold the button to cancel and the icon will go out, the display will briefly show **UNLOCKED**.

The Display

GB

Selecting your language

The first time you turn on your dryer you should select your preferred language from the available list.

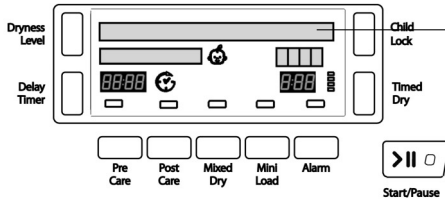

To change: the language current selection must flash, on the first line of the display.

- Press and hold all 3 buttons: Child Lock, Timed Dry and Dryness Level for 5 seconds.
- Press the Child Lock or the Timed Dry button to scroll up or down through the list.
- When your required language is flashing on the top line of the display, pressing the Dryness Level button will select your choice.

Understanding the display

Programme selection and display

The selected programme is shown on the first line of the display when you select the corresponding button, this message is shown while the programme is running.

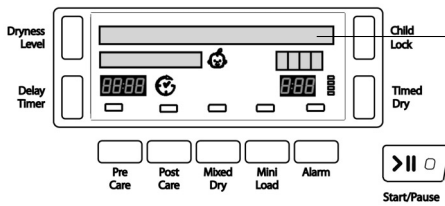

- COTTON HIGH HEAT
- COTTON LOW HEAT
- SYNTHETICS
- BED & BATH
- EASY IRON
- AIRING
- DELICATES
- WOOL

Memory: When you select the memory button the Display will show your selected programme with 'M' before its name. ie. **M COTTON HIGH HEAT** (see *Start and Programmes*).

Dryness levels

During programme selection for an automatic programme that has different dryness levels available (see *Programmes Table*).

The second line of the display shows the dryness level you require, for each press of the Dryness Level button the next option from the list below is selected and displayed.

- IRON DRY
- HANGER DRY
- CUPBOARD DRY

- Iron Dry:** Dries your clothes ready for ironing.
- Hanger Dry:** Dries your clothes ready for hanging.
- Cupboard Dry:** Dries your clothes ready for wearing.

The display also shows: one, two or three blocks, depending on your selection. These are displayed during the programmes progress.

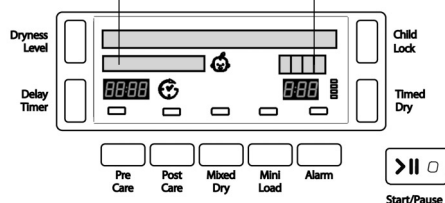

The Display



Programme progress

The second line of the display shows the status of the programme as it progresses: (long messages scroll across the line)

- PRE CARE (if option Pre Care available and selected).
- DRY
- COOL TUMBLE
- END OF CYCLE, POST CARE PHASE (if option Post Care available and selected).
- END OF CYCLE, EMPTY THE WATER BOTTLE

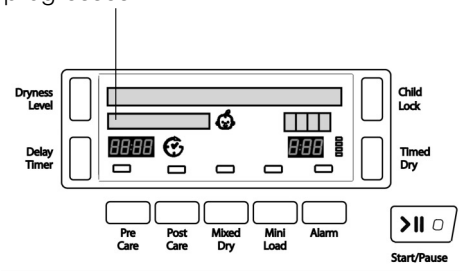

If the Mixed Dry option is available and selected this line displays when the different dryness levels have been reached:

- IRON DRY REACHED
- HANGER DRY REACHED

Timed drying

After selecting a programme that has a Timed Dry option, press the Timed button and the display will increment the selected time, each time you press and release the button (see *Start and Programmes*).

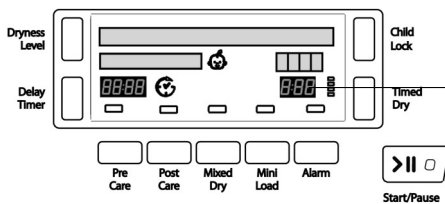

Each press advances: 0:20 0:40 1:00 1:20 1:40 2:00 2:20 then **■■■■**, and then repeats.

Delicates have a maximum time of: 1:40

The bars to the right of the time, light to give an indication of the time duration selected:

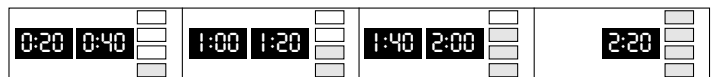

The selected time remains displayed after the programme starts.

Delay and Time to End

Some programmes can have a delayed start (see *Start and Programmes*). Press the Delay Timer button and the icon flashes.

Each press of the Delay Timer button advances the delay setting in 1 hour increments, from: 1h to 24h, then OFF and then after a couple of seconds cancels the delay.

The delay time is shown on the display next to the Delay Timer button.

The display counts down the minutes of the delay period after the Start/Pause button >|| is pressed.

The second line of the display shows STARTS IN

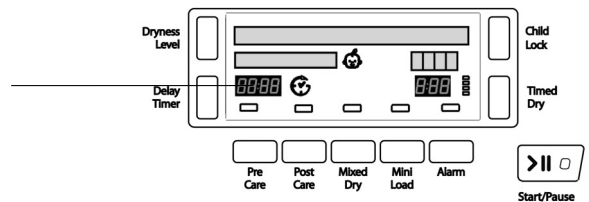

After the delay period finishes (or for all of the programme if delay not selected): The estimated Time to End of the programme for automatic programmes or the actual time remaining during the Timed programme is shown in this part of the display.

GB

Important Information

Installation

Description

The Display

Start and Programmes

Laundry

Warnings and Suggestions

Maintenance and Care

Troubleshooting

Service

The Display

GB

Warnings

The second line of the display also gives warnings and reminders: (reminders occur at the end of the programme)

END OF CYCLE, EMPTY THE WATER BOTTLE

- Reminder that the water container should be emptied every time you use the dryer (*see Maintenance*).

EMPTY WATER BOTTLE

- Indicates that the water container is full. The message will take a few seconds to go out after replacing the empty water container; the dryer must be running for this to happen (*see The Controls*).

Note: If the water container fills and this message is displayed, the heat is turned off and your clothes will not dry.

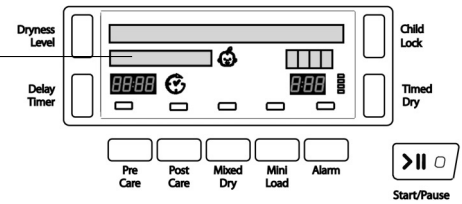

CLEAN CONDENSER

- This message indicates that you must clean the Condenser unit (*see Maintenance*) and will occur at intervals depending how much you have used the dryer. When you finish the next programme the message is cancelled.



CLEAN FILTER

- Reminds you to clean the Filter every time you use the dryer (*see Maintenance*).

Start and Programmes

Choosing a programme

1. Plug the dryer into the electrical socket.
2. Sort your laundry according to fabric type (*see Laundry*).
3. Open the door and make sure the filter is clean and in place and the water container is empty and in place (*see Maintenance*).
4. Load the machine and make sure items are not in the way of the door seal. Close the door.
5. If the Display is not lit: Press the On/Off button .
6. Press the Programmes Selection button that corresponds with the type of fabric being dried by checking the Programmes Table (*see Programmes*) as well as the indications for each type of fabric (*see Laundry*).
 - If the **Memory** button is selected; steps 7, 8 and 9 are not required (*see below*).
7. Choose Timed Dry or Dryness Level option:
 - If Timed Drying press and release the Timed Dry button until the required time is displayed.
 - or - To change from default dryness setting, press and release the Dryness Level button until the required level is indicated.

! See Programmes Table, for more details.
8. Set a delay time and other options if necessary (*see The Display*).
9. If you wish the buzzer to sound at the end of the programme, press the Alarm button.
10. Press the Start/Pause button  to begin. The display will show the estimated time to end. During the drying programme, you can check on your laundry and take out items that are dry while others continue drying. When you close the door again, press the Start/Pause button  in order to resume drying.
11. During the last few minutes of Drying Programmes, before the programme is completed, the final COOL TUMBLE phase is entered (fabrics are cooled), this phase should always be allowed to complete.
12. The buzzer (if option selected) will warn you when the programme is complete and the Display shows **END OF CYCLE, POST CARE PHASE**. Open the door, take the laundry out, clean the filter and replace it. Empty the water container and replace it (*see Maintenance*). If the Post Care option has been selected and you do not remove the laundry immediately, the dryer will tumble occasionally for 10 hours or until you open the door.
13. Unplug the dryer.

Memory button:

First time you press this button the display will show **PRESS AND HOLD TO STORE**

After selecting your favourite programme and options you can save these settings by pressing and holding in the Memory button for at least 5 seconds, the buzzer will then beep and the second line of the display shows **MEMORY**. The next time you need this programme press the Memory button, then the Start/Pause button  and this programme will run.

If you wish, you can change your stored favourite, by selecting a new programme and/or options and press and hold in the Memory button (*as above*).

Special Programmes

Easy Iron Programme

'Easy Iron' is a short 10 minute programme (8 minutes of heat followed by a 2 minute cool tumble period) which fluffs the fibres of clothing that have been left in the same position/location for an extended period of time. The cycle relaxes the fibres and makes them easier to iron and fold.

! 'Easy Iron' is **not a drying programme** and should not be used for wet articles of clothing.

For best results:

1. Do not load more than the maximum capacity. These numbers refer to the dry weight:

Fabric	Maximum load
Cotton and Cotton mixtures	2.5kg
Synthetics	2kg
Denim	2kg

2. Unload the dryer immediately after the end of the programme, hang, fold or iron the articles and put them away in the closet. Should this not be possible repeat the programme.

The 'Easy Iron' effect varies from one fabric to the next. It works well on traditional fabrics like Cotton or Cotton mix, and less well on acrylic fibres and on materials such as Tencel®.

Wool Programme

- This is a programme for tumble dryer safe garments marked with the symbol .
- It can be used for load sizes up to 1kg (approximately 3 sweaters).
- We recommend that garments are turned inside out before drying.
- This programme will take about 60 minutes, but may take longer depending on the size and density of the load and the spin speed used in your washer.
- Loads dried using this programme are usually ready to wear, but on some heavier garments the edges may be slightly damp. Allow these to dry naturally as over-drying could damage garments.

! Unlike other materials, the mechanism of wool shrinkage is irreversible; i.e. it will not stretch back to original size and shape.

! This programme is not suitable for Acrylic garments.

Programme option modifiers

Mixed Dry

Available with Cotton High Heat and Synthetic programmes.

This option used after selecting either a Cupboard Dry or Hanger Dry dryness level. This allows you to remove items when they have reached Hanger Dry or Iron Dry.

When the dryer detects that the load has reached Iron Dry, the display shows: **IRON DRY REACHED** and the buzzer sounds for 2 minutes, open the door and remove items that you need to iron.

Then close the door and press the Start/Pause button **>||** and the programme resumes.

! If you do not open the door during the 2 minute period, the dryer will resume drying without you pressing the Start/Pause button.

Hanger Dry programme then continues and ends with **END OF CYCLE. EMPTY THE WATER BOTTLE**

Cupboard Dry programme continues until the dryer detects that the load has reached Hanger Dry, the display shows: **HANGER DRY REACHED** and the buzzer sounds for 2 minutes, open the door and remove any items that you need to hang up to finish drying.

Then close the door and press the Start/Pause button **>||** and the programme resumes.

! If you do not open the door during the 2 minute period, the dryer will resume drying without you pressing the Start/Pause button.

When Cupboard Dry dryness level reached, the dryer completed the cool tumble (and, if selected, Post Care) and ends with **END OF CYCLE. EMPTY WATER BOTTLE**

Mini Load

Available with Cotton High Heat and Synthetic programmes. Used for loads between 1 and 2kg.

This programme optimises Automatic programme for smaller loads and improves the Time to End estimation.

Start and Programmes

GB

Programmes Table

! If the Display is not lit; Press the ON/OFF button  and then select programme.

Programme	What it does...	How to set it...	Note:
Cottons - High Heat	Dries your Cotton clothes on High Heat.	<ol style="list-style-type: none"> Press the Cottons - High Heat button. Choose Timed Dry or Automatic Dryness Level option. <ul style="list-style-type: none"> If Timed Dry, <i>see next page</i>, or... To change from default dryness setting press and release Dryness Level button until the required level is displayed. Select any Options if required. Press the Start/Pause button >II. 	<p>Options available: Alarm, Delay Timer, Pre Care, Post Care, Mini Load, *Mixed Dry</p> <p>Dryness options Automatic Dryness Levels:</p> <p><input type="text" value="IRON DRY"/></p> <p><input type="text" value="HANGER DRY"/></p> <p><input type="text" value="CUPBOARD DRY"/> : default</p>
Cottons - Low Heat	Dries your Cotton clothes on Low Heat.	<ol style="list-style-type: none"> Press the Cottons - Low Heat button. Select a drying time, <i>see Timed Dry, next page</i>. 	<p>Options available: <i>See Timed Dry, next page.</i></p>
Synthetics	Dries your Synthetic clothes on High Heat.	<ol style="list-style-type: none"> Press the Synthetics button. Choose Timed Dry or Automatic Dryness Level option. <ul style="list-style-type: none"> If Timed Dry, <i>see next page</i>, or... To change from default dryness setting press and release Dryness Level button until the required level is displayed. Select any Options if required. Press the Start/Pause button >II. 	<p>Options available: Alarm, Delay Timer, Pre Care, Post Care, Mini Load, *Mixed Dry</p> <p>Dryness options Automatic Dryness Levels:</p> <p><input type="text" value="IRON DRY"/></p> <p><input type="text" value="HANGER DRY"/></p> <p><input type="text" value="CUPBOARD DRY"/> : default</p>
Bed & Bath	Dries your towels and bedding on High Heat.	<ol style="list-style-type: none"> Press the Bed & Bath button. Select any Options if required. Press the Start/Pause button >II. 	<p>Options available: Alarm, Delay Timer, Pre Care, Post Care.</p> <ul style="list-style-type: none"> An Automatic programme
Wool	Dries your Woollen clothes, (<i>see previous page</i>).	<ol style="list-style-type: none"> Press the Wool button. Select Alarm option if required. Press the Start button >II. 	<p>Options available: Alarm</p> <ul style="list-style-type: none"> An Automatic programme
Delicates (e.g. Acrylics)	Dries your clothes on Low heat setting, ready to be worn.	<ol style="list-style-type: none"> Press the Delicates button. If Timed Dry programme required (<i>see Timed Dry next page</i>). Otherwise default is Automatic. Select any Options, if required. Press the Start/Pause button >II. 	<p>Options available: Alarm, Delay Timer, Pre Care, Post Care.</p> <ul style="list-style-type: none"> The default is Automatic
Airing	20-minute programme that airs your clothes with cool air. Use also to cool warm clothes.	<ol style="list-style-type: none"> Press the Airing button. Select Alarm option if required. Press the Start/Pause button >II. 	<p>Options available: Alarm</p>
Easy Iron	Brief programme (approximately 10 minutes) that softens fibres of clothing that is ready for ironing.	<ol style="list-style-type: none"> Press the Easy Iron button. Select Alarm option if required. Press the Start/Pause button >II. 	<p>! This is not a drying programme (<i>see previous page</i>).</p> <p>Options available: Alarm</p>

Note: *Mixed Dry only available with Cupboard Dry and Hanger Dry (*see Programme option modifiers*).

Start and Programmes



Timed programmes table: First select a programme (*see Programmes Table*).

<p>Timed Drying (0:20, 0:40, 1:00, 1:20, 1:40, 2:00 or 2:20 Hours:Minutes)</p>	<p>Always use Timed Drying for loads less than 1kg, or if you prefer a different dryness result.</p> <p>The heat setting depends on the programme (material option) selected.</p>	<ol style="list-style-type: none"> 1. Press and release the Timed button until the display shows the required selection. Each press advances 0:20, 0:40, 1:00, 1:20, 1:40, 2:00 then 2:20 and then repeats. • Delicates have maximum time of 0:40. • When 0:00 is displayed, Automatic Dryness Level option is available if you change your mind. 2. Select any Options if required. 3. Press the Start button >II. 	<p>Options available: Alarm, Delay Timer, Pre Care, Post Care.</p> <p>Consult suggested drying times (<i>see Laundry</i>).</p> <p>The last 10 minutes of these programmes is the Cool Tumble phase.</p>
---	---	---	--

The Controls

! Warning, after pressing the Start/Pause button **>II**, the programme cannot be changed.

To change a selected programme, press the Start/Pause button **>II**, the light flashes Amber to indicate the programme is paused. Select the new programme and any options required, the light will then flash green. Press the Start/Pause button **>II** again and the new programme will start.

• Option buttons

These buttons are used to customise the selected programme to your requirements. A programme must have been selected, by pressing a programme selection button, before an option can be selected. Not all options are available for all programmes (*see Programmes Table*). If an option is not available and you press the button, the buzzer will beep 3 times. If the option is available the indicator, on the display unit next to the bottom buttons, lights to show that the option has been selected.

Time Delay (Delay Timer)

The start of some programmes (*see The Display and Start and Programmes*) can be delayed for up to 24 hours. Ensure the water container is emptied before setting a delayed start.

Pre Care

This option is only available if a delayed start has been selected. It tumbles the clothes occasionally during the delayed period to help prevent creases developing.

Alarm

Available on all programmes and allows the buzzer to give a signal at the end of the drying cycle, to remind you that the clothes are ready to be removed.

Post Care

When available and selected, the clothes are occasionally tumbled after the end of the drying and cool tumble cycles, to help prevent creases developing should you not be available to remove the load immediately the programme is complete.

• TIME DISPLAY **88:88**

The display shows either the amount of time delay remaining or an indication of the amount of time left for a drying programme (*see The Display*).

The delay or time to end is displayed in hours and minutes and counts down each minute.

When timed programmes are selected the time displayed throughout the cycle is the actual time

remaining.

When an Automatic programme is selected, the time displayed is an estimate of the time remaining. When the programme is selected the display shows the time required to dry a full load, after around 10 minutes the controller calculates a better estimate of the cycle time. The colons between the hours and minutes in the display flash to show that the time is counting down. The display also shows if there is a problem with your dryer, if this occurs the display will show F followed by a fault code number (*see Troubleshooting*).

• Empty Water Container

(If you have plumbed your dryer to a drain messages about emptying the water container can be ignored, as there is no need to empty the container).

Messages are displayed to remind you to empty the water container (*see The Display*).

If the water container fills during a programme, the heater turns off and the dryer does a period of Cool Tumble. After this it stops and a message tells you to **EMPTY THE WATER CONTAINER**.

You must empty the water container and restart the dryer or the clothes will not dry. After re-starting the dryer the message will take a few seconds to go out. To avoid this always empty the water container each time you use the dryer (*see Maintenance*).

• Door Opening

Opening the door during a programme will stop the dryer and have the following effects:

- The display shows **PAUSED**.
- During a delay phase the delay will continue to count down. The Start/Pause button **must** be pressed to resume the delay programme. The display will change to show current status.
- During the drying part of the programme, the colons on the display stop flashing to show that the time has stopped counting down. The Start/Pause button **must** be pressed to resume the programme. The display will change to show the current status, the colons flash and count down continues.
- During the Post Care phase, the programme ends. Pressing the Start/Pause button will restart a new programme from the beginning.

• Note

If you have a power cut, switch off the power or remove the plug. When power is restored, press the Start/Pause button and the programme will resume.

GB

Important Information

Installation

Description

The Display

Start and Programmes

Laundry

Warnings and Suggestions

Maintenance and Care

Troubleshooting

Service

Laundry

GB

Sorting your laundry

- Check symbols on clothing labels to make sure that the articles can be tumble dried.
- Sort laundry by fabric type.
- Empty pockets and check buttons.
- Close zippers and hooks and tie loose belts and strings.
- Wring out each item in order to eliminate as much excess water as possible.

! Do not load dripping wet clothes into the dryer.

Maximum load size

Do not load more than maximum capacity.

These numbers refer to dry weight:

Natural fibres: 7kg max (15lb)

Synthetic fibres: 3kg max (6.6lb)

! DO NOT overload the dryer as this could result in reduced drying performance.

Typical weights

Note: 1kg = 1000g (1lb = 16oz)

Clothes			
Blouse	Cotton	150g	(5oz)
	Other	100g	(3oz)
Dress	Cotton	500g	(1lb 2oz)
	Other	350g	(12oz)
Jeans		700g	(1lb 6oz)
10 nappies		1000g	(2lb 3oz)
Shirt	Cotton	300g	(10oz)
	Other	200g	(7oz)
T-Shirt		125g	(4oz)

Household Items





Duvet cover (Double)	Cotton	1500g	(3lb 5oz)
	Other	1000g	(2lb 3oz)
Large Tablecloth		700g	(1lb 6oz)
Small Tablecloth		250g	(9oz)
Tea Towel		100g	(3oz)
Bath Towel		700g	(1lb 6oz)
Hand Towel		350g	(12oz)
Double Sheet		500g	(1lb 2oz)
Single Sheet		350g	(12oz)

At the end of a drying cycle, cottons could still be damp if you grouped cottons and synthetics together. If this happens simply give them an additional short period of drying.

- **Note:** The last 10 minutes of any time set is the Cool Tumble, so allow for this when setting the time, as this period will not dry your laundry.

Wash Care Labels

Look at the labels on your garments, especially when tumble drying for the first time. The following symbols are the most common:

-  May be tumble dried
-  Do **not** tumble dry
-  Tumble dry at high heat setting
-  Tumble dry at low heat setting

Items not suitable for tumble drying

- Articles that containing rubber or rubber-like materials or plastic film (pillows, cushions, or PVC rainwear), any other flammable articles or objects that contain flammable substances (towels soiled with hair spray).
- Glass fibres (certain types of draperies)
- Items which have been dry cleaned
- Items with the ITCL Code  (*see Special clothing items*). These can be cleaned with special at-home dry cleaning products. Follow instructions carefully.
- Large bulky items (quilts, sleeping bags, pillows, cushions, large bedspreads etc). These expand when drying and would prevent airflow through the dryer.

Special clothing items

Blankets and Bedspreads: acrylic items (Acilan, Courtelle, Orion, Dralon) **must be dried** with special care on LOW heat setting. Avoid drying for a long period of time.

Pleated or creased garments: read the manufacturer's drying instructions on the garment.

Starched articles: do not dry these with non-starched items. Make sure that as much of the starch solution is removed from the load as possible before placing it in the dryer. Do not over-dry: the starch will become powdery and leave your clothing limp, which defeats the purpose of starch.

Drying times

Times are approximate and can vary depending upon:

- Amount of water retained in clothes after spin cycle: towels and delicates retain a lot of water.
- Fabrics: items that are the same type of fabric but different textures and thicknesses may not have the same drying time.
- Quantity of laundry: single items or small loads may take longer to dry.

- Dryness: If you are going to iron some of your clothes, they can be taken out while still a bit damp. Others can be left longer if you need them to be completely dry.
- Heat setting.
- Room temperature: if the room where the dryer is located is cold, it will take longer for the dryer to dry your clothes.
- Bulk: some bulky items can be tumble dried with care. We suggest that you remove these items several times, shake them out, and return them to the dryer until finished.

! Do not over-dry your clothes. All fabrics contain a little natural moisture, which keeps them soft and fluffy.

The table (*see below*) presents APPROXIMATE drying times in Hours : Minutes, as you see them on the display, the times are also shown in Minutes only for reference.

The times given are for Cupboard Dry Automatic programmes.

Timed Dry settings are also shown, to help you choose a suitable time option.

Weights refer to dry garments.

Cottons 				Half Load				Full Load
		1 kg	2 kg	3 kg	4 kg	5 kg	6 kg	7 kg
	Automatic duration	0:30 - 0:40	0:40 - 0:55	0:55 - 1:10	1:10 - 1:20	1:20 - 1:30	1:35 - 2:00	2:00 - 2:20
	Automatic minutes	30 - 40	40 - 55	55 - 70	70 - 80	80 - 90	95 - 120	120 - 140
	Timed Dry setting	0:20 or 0:40	0:40 or 1:00	1:00 or 1:20	1:00 or 1:20	1:20 or 1:40	1:40 or 2:00	2:00 or 2:20
Drying times 800-1000 rpm in washing machine.								
Synthetics 		1 kg		Half Load		Full Load		
		1 kg		2 kg		3 kg		
	Automatic duration	0:40 - 0:50		0:50 - 1:10		1:10 - 1:30		
	Automatic minutes	40 - 50		50 - 70		70 - 90		
	Timed Dry setting	0:40 or 1:00		0:40 or 1:20		1:00 or 1:20 or 1:40		
Drying times on reduced spin in washing machine.								
Delicates (Acrylics) 		Half Load			Full Load			
		1 kg			2 kg			
	Automatic duration	0:40 - 1:20			1:20 - 1:40			
	Automatic minutes	40 - 80			80 - 100			
	Timed Dry setting	0:40 or 1:00 or 1:20			1:20 or 1:40			
Drying times on reduced spin in washing machine.								

Warnings and Suggestions

GB

! The appliance has been designed and built according to international safety standards. These warnings are given for safety reasons and must be followed carefully.

General safety

- This tumble dryer is not intended for use by persons (including children) with reduced physical, sensory or mental capabilities, or lack of experience and knowledge, unless they have been given supervision or instruction concerning use of the appliance by a person responsible for their safety.
- This tumble dryer has been designed for home, and not professional use.
- Do not touch the appliance while barefoot or with wet hands or feet.
- Unplug the machine by pulling on the plug, not the cord.
- Children must not be in proximity of the dryer when in use. After using the dryer, turn it off and unplug it. Keep the door closed to make sure that children do not use it as a toy.
- Children should be supervised to ensure that they do not play with the dryer.
- The appliance must be installed correctly and have proper ventilation. The air intake at the front of the dryer and rear vent behind the dryer should never be obstructed (*see Installation*).
- Never use the dryer on carpeting where the pile height would prevent air from entering the dryer from the base.
- Check to see if the dryer is empty before loading it.
-  The back of the dryer could become very hot. Never touch it while in use.
- Do not use the dryer unless the filter, water container and condenser are securely in place (*see Maintenance*).
- Do not use liquid fabric softeners in the dryer, add it to the final rinse of your wash.
- Do not overload the dryer (*see Laundry* for maximum loads).
- Do not load items that are dripping wet.
- Tumble dry items only if they have been washed with detergent and water, rinsed and been through the spin cycle. It is a fire hazard to dry items that HAVE NOT been washed with water.
- Carefully check all instructions on clothing labels (*see Laundry*).
- Do not dry garments that have been treated with chemical products.
- Never dry articles that are contaminated with flammable substances (cooking oil, acetone, alcohol, petrol, kerosene, spot removers, turpentine, waxes, wax removers and hair sprays), unless washed in hot water with an extra amount of detergent.
- Do not tumble dry rubber, rubber backed articles and clothes, pillows fitted with foam rubber pads, foam (latex foam), rubber, plastic, shower caps, waterproof textiles, nappy pants or liners, polythene or paper.

- Do not tumble dry large, very bulky items.
- Do not tumble dry acrylic fibres at high temperatures.
- Remove all objects from pockets, especially lighters (risk of explosion).
- Complete each programme with its Cool Tumble Phase.
- Do not turn off the dryer when there are still warm items inside.
- Clean the filter after each use (*see Maintenance*).
- Empty the water container after each use (*see Maintenance*).
- Clean the condenser unit at regular intervals (*see Maintenance*).
- Do not allow lint to collect around the dryer.
- Never climb on top of the dryer. It could result in damage.
- Always follow electrical standards and requirements (*see Installation*).
- Always buy original spare parts and accessories (*see Service*).

! **WARNING:** Never stop the dryer before the end of the drying cycle unless all items are quickly removed and spread out so that the heat is dissipated.

Recycling and disposal information



As part of our continued commitment to helping the environment, we reserve the right to use quality recycled components to keep down customer costs and minimise material wastage.

- Disposing of the packaging material: follow local regulations, so the packaging can be recycled.
- To minimise risk of injury to children, remove the door and plug - then cut off mains cable, flush with the appliance. Dispose of these parts separately to ensure that the appliance can no longer be plugged into a mains socket.

Disposal of old electrical appliances

The European Directive 2002/96/EC on Waste Electrical and Electronic Equipment (WEEE), requires that old household electrical appliances must not be disposed of in the normal unsorted municipal waste stream. Old appliances must be collected separately in order to optimise the recovery and recycling of the materials they contain and reduce the impact on human health and the environment.



The crossed out "wheeled bin" symbol on the product reminds you of your obligation, that when you dispose of the appliance it must be separately collected.

Consumers should contact their local authority or retailer for information concerning the correct disposal of their old appliance.

Saving energy and respecting the environment

- Wring out items to eliminate excess water before tumble drying (if you use a washing machine first, select a high spin cycle). Doing this will save time and energy during drying.
- Always dry full loads - you save energy: single items or small loads take longer to dry.
- Clean the filter after each use to contain energy consumption costs (*see Maintenance*).

Maintenance and Care

Switching off the electricity

! Unplug your dryer when not using it, when cleaning it and during all maintenance operations.

Clean the filter after each cycle

The filter is an important part of your dryer: it accumulates lint and fluff that is formed while drying. When finished drying, clean the filter by rinsing it under running water or with your vacuum cleaner. Should the filter become clogged up, the airflow inside the dryer will be seriously compromised: drying times lengthen and you will consume more energy. It may also damage your dryer.

The filter is found in front of the dryer trim (*see diagram*). Removing the filter:

1. Pull the plastic grip of the filter upwards (*see diagram*).
2. Clean the filter and replace it correctly.
Ensure the filter is fully located flush into the tumble dryer trim.

! Do not use the dryer without replacing the filter.

Empty the water container after each cycle

Pull the container out of the dryer and empty it into a sink or other suitable drain.

Replace the water container securely.

Always check and empty the container before you start a new drying programme.

Check the drum after each cycle

Turn the drum manually in order to remove small items (handkerchiefs) that could have been left behind.

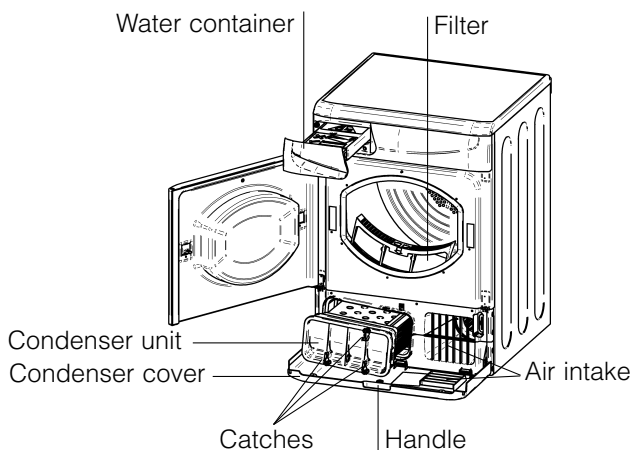

Cleaning the drum

! Do not use abrasives, steel wool or stainless steel cleaning agents to clean the drum.

A coloured film may start to appear on the stainless steel drum, this may be caused by a combination of water and, or cleaning agents such as fabric conditioner from the wash. This coloured film will not affect the dryer performance.

Cleaning the condenser unit

Periodically (every month) remove the condenser unit and clean any build up of fluff from between the plates by rinsing it under the tap with cold water.

This should be done with cold water from the rear of the condenser.

Removing the condenser:

1. Unplug the dryer and open the door.
2. Pull open the condenser cover (*see diagram*).
Release the three catches by turning 90° counter-clockwise then pull on the grip and remove from the dryer.
3. Clean the surface of the seals and replace, making sure that the catches have been secured.

Cleaning the dryer

- External parts in metal or plastic and rubber parts can be cleaned with a damp cloth.
- Periodically (every 6 months) vacuum the front air intake grille and vents at the rear of the dryer, to remove any build up of fluff, lint or dust. Also to remove accumulation of fluff from the front of the condenser and filter areas, clean occasionally with a vacuum cleaner.

! Do not use solvents or abrasives.

! Your dryer uses special bearing components which do not need lubrication.

! Have your dryer checked regularly by authorised technicians to ensure electrical and mechanical safety (*see Service*).

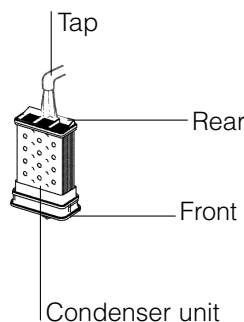

Troubleshooting

GB

One day your dryer seems not to be working. Before you call your Service Centre (*see Service*), go through the following troubleshooting suggestions:

Problem:

Possible causes / Solution:

The tumble dryer won't start.

- The plug is not plugged into the socket, or not making contact.
- There has been a power failure.
- The fuse has blown. Try to plug another appliance into the socket.
- You are using an extension cord? Try to plug the dryer's power cord directly into the socket.
- The door is not closed securely?
- The programme has not been set properly (*see Start and Programmes*).
- The Start/Pause button has not been pressed (*see Start and Programmes*).

Drying cycle will not begin.

- You have set a delayed time (*see Start and Programmes*).

Its taking a long time to dry.

- The filter has not been cleaned (*see Maintenance*).
- The water container needs emptying? The empty water message is displayed? (*see Maintenance*).
- The condenser needs cleaning? (*see Maintenance*).
- The temperature setting is not ideal for the type of fabric you are drying (*see Start and Programmes, and see Laundry*).
- The correct drying time has not been selected for the load (*see Laundry*).
- The air intake grille or rear vents are obstructed (*see Installation, and see Maintenance*).
- The items were too wet (*see Laundry*).
- The dryer was overloaded (*see Laundry*).

Empty water message is displayed but the dryer has only been running for a short period.

- The water container was probably not emptied at the start of the programme. Do not wait for the empty water signal, always check and empty the container before starting a new drying programme (*see Maintenance*).

Empty water message is displayed and the water container is not full.

- This is normal, the: **END OF CYCLE, EMPTY THE WATER BOTTLE** message is shown as a reminder to empty the container (*see The Display and Start and Programmes*).

Programme finishes and clothes are damper than expected.

! For safety the dryer has a maximum programme time of 3 hours. If an automatic programme has not sensed the required final moisture in this time the dryer will complete the programme and stop. Check the above points and run the programme again, if the results are still damp, contact the Service Centre (*see Service*).

The display shows a fault code F followed by one or two numbers.

- If the display shows F10 or F15:
 - Turn off and remove the plug. Clean the filter and the condenser (*see Maintenance*). Then replace the plug, turn on and start another programme. If F10 or F15 is still displayed contact the Service Centre (*see Service*).
- If any other number is shown: Note down the code and contact the Service Centre (*see Service*).

The display briefly shows **DEMO ON every 6 seconds.**

- The dryer is in 'Demo' mode. Press and hold both the On/Off and Start/Pause buttons for 3 seconds. The display will show **DEMO OFF** for 3 seconds and then the dryer will resume normal operation.

Before calling the Service Centre:

- Use the troubleshooting guide to see if you can solve the problem yourself (*see Troubleshooting*).
- If not, turn off the dryer and call the Service Centre closest to you.

What to tell the Service Centre:

- name, address and post code.
- telephone number.
- the type of problem.
- the date of purchase.
- the appliance model (Mod.).
- the serial number (S/N).

This information can be found on the data label inside the door of the machine.

Spare Parts



This dryer is a complex machine. Repairing it yourself or having a non-authorised person try to repair it could cause harm to one or more persons, could damage the machine and could invalidate the spare parts warranty.

Call an authorised technician if you experience problems while using the machine.

The spare parts have been designed exclusively for this appliance and not for other uses.

Comparative Programmes

- Programmes recommended for comparative test to EN61121

Programme (EN61121)	Programme to select	Load size	Dryness Option
Dry Cotton	COTTONS HIGH HEAT 	7 kg	HANGER DRY
Iron Dry Cotton	COTTONS HIGH HEAT 	7 kg	IRON DRY
Easy-care textile	SYNTHETICS 	3 kg	CUPBOARD DRY

! Note: This is not a full list of programme options (*see Start and Programmes*).



This appliance conforms to the following EC Directives:

- 2006/95/EC (Low Voltage Equipment)
- 89/336/EEC, 92/31/EEC and 93/68/EEC (Electromagnetic Compatibility)



195067259.00 W

01/2008 - SIMLEX . Four Ashes, Wolverhampton



Key Contacts

After Sales Service

Over 1100 trained specialists, directly employed by us, ensure that you can have complete confidence in both the appliances and services we offer.

Repair Service and Information Help Desk

UK: 08709 066 066

Monday to Friday, 8am to 7.30pm

Saturday, 8.30am to 5.30pm

Sunday, 9.30am to 3.30pm

www.hotpointservice.co.uk

Republic of Ireland: 0818 313 413

Note: Our operators will require the following information:

Model number

Serial number

Extended Warranties

UK: 08709 088 088

Monday to Sunday, 8am to 8pm

www.hotpointservice.co.uk

Republic of Ireland: 0123 002 333

Genuine Parts and Accessories

UK: 08709 077 077

Monday to Friday, 8.30am to 5pm

Saturday, 8.30am to 12noon

www.hotpointservice.co.uk

Republic of Ireland: 0818 313 413

www.hotpoint.co.uk