

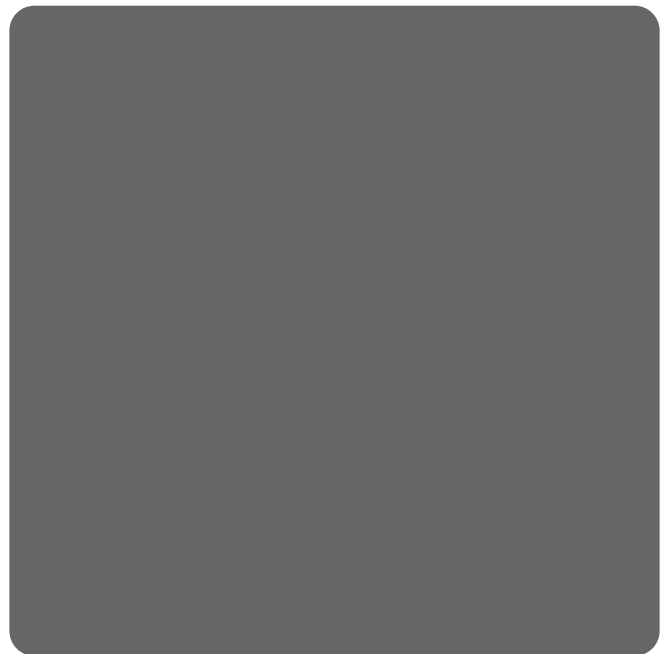

Designed for the real world

# Instructions



CTD80  
CTD85



GB

English

GB

## Contents

### Installation, 2

- Door reversal instructions
- Where to put your dryer
- Ventilation
- Water drain
- Electrical connection
- Before you start using your dryer

### Dryer description, 3

- To open the door
- The features
- Control panel

### Start and programmes, 4-6

- Choosing a programme
- Table of programmes
- The controls
- Option buttons / lights
- Display
- Door Opening

### Laundry, 7-8

- Sorting your laundry
- Wash care labels
- Special clothing items
- Drying times

### Warnings and Suggestions, 9

- General safety
- Disposal
- Saving energy and respecting the environment

### Maintenance and Care, 10

- Switching off the electricity
- Cleaning the filter after each cycle
- Empty the water container after each cycle
- Check the drum after each cycle
- Cleaning the condenser unit
- Cleaning the dryer

### Troubleshooting, 11

### Service, 12

- Spare parts

# Installation

GB

! Keep this instruction booklet on hand in order to refer to it when necessary. Take it with you when you move, and should you sell this appliance or pass it on to another party, make sure that this booklet is supplied along with the dryer so that the new owner may be informed about warnings and suggestions on how the dryer works.

! Read these instructions carefully; the following pages contain important information on installation and suggestions on how the appliance works.

## Door Reversal Instructions

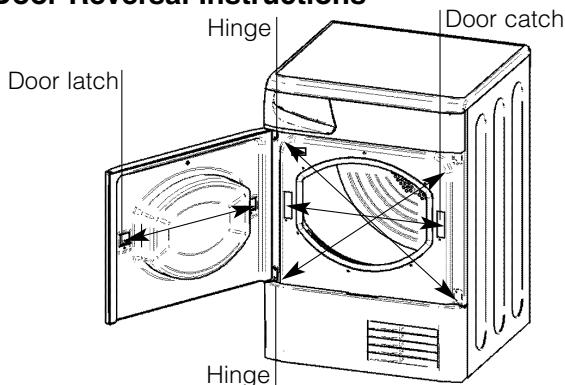

The door of your dryer is reversible and can easily be changed. Exchange diagonally hinge brackets and blanking screws. Exchange door latch and catch with their opposite blanking plates (*see diagram above*).

## Where to put your dryer

- Place your dryer at a distance from gas ranges, stoves, heaters, or cook tops because flames can damage the appliance.
- If you are going to install the appliance under a work counter, be sure to leave a 10mm space between the top and any other objects on or above the machine and a 15mm space between the sides and lateral furnishings or walls. This is to ensure proper air circulation. Make sure that the back vents are not obstructed.

## Ventilation

When the dryer is in use, there has to be adequate ventilation. Make sure you put your dryer in an environment that is not damp and has proper air circulation throughout. Airflow around the dryer is essential to condense the water produced during the washing, the dryer will not operate efficiently in an enclosed space or cupboard.

! If using the dryer in a small or cold room some condensation could be experienced.

! We do not recommend that the dryer is installed in a cupboard but the dryer must never be installed behind a lockable door, a sliding door or a door with a hinge on the opposite side to that of the dryer door.

## Water drain

If your dryer is installed next to a drain the water can be plumbed into this drain. This does away with the need to empty the water container. Simply remove the top hose from its top fitting at the rear of the dryer and plumb the hose provided to the drain.

## Electrical connections

Make sure of the following before you insert the plug into the electrical socket:

- The socket must be grounded.
- The socket must be able to sustain the machines maximum power, which is indicated on the rating label (*see Dryer Description*).
- Power voltage must be within the values indicated on the rating label (*see Dryer Description*).
- The socket must be compatible with the dryers plug. Should this not be the case, replace the plug or the socket.

! The dryer must not be installed outdoors, even if the space is sheltered. It can be very dangerous if it is exposed to rain or storms.

! Once installed, the dryers electrical wire and plug must be within easy reach.

! Do not use extension cords.

! The power cord must not be bent or squashed.

! The power cord supplied is fitted with a BS1363 plug and a 13 amp BS1362 fuse. If you need to replace the fuse, use only those rated at 13 amp (13A) and ASTA approved to BS1362.

## Moulded plug

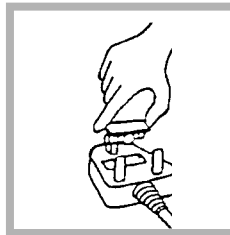

! The plug must not be used without the fuse cover in place.

If a replacement fuse holder/cover is required, it must be of the same colour coding or wording as shown on the base of the plug. Replacements are available from authorised dealers.

## Changing the plug

The wires in the power cord are coloured in accordance with the following:

Green and Yellow (Earth) wire to terminal marked 'E', symbol  $\perp$ , or coloured green and yellow.

Blue (Neutral) wire to terminal marked 'N' or coloured black.

Cord clamp

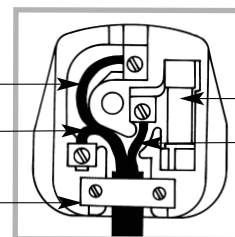

13A ASTA approved fuse to BS1362.

Brown (Live) wire to terminal marked 'L' or coloured red.

! If the plug being replaced is a non-rewirable type, then the cut-off plug must be disposed of safely. DO NOT leave it where it can be inserted into a socket and create a shock hazard.

! The power supply cord should be checked periodically and replaced by a cord specially prepared for this dryer and fitted only by authorised technicians (*see Service*). New or longer power cords are supplied at an extra charge by authorised dealers.

! The manufacturer denies any responsibility should any of these rules not be followed.

! If in doubt about any of the above consult a qualified electrician.

## Before you start using your dryer

Once you have installed your dryer and before you use it, clean the inside of the drum to remove any dust that could have accumulated during transport.

# Dryer Description



## To open the door

Press and release the front panel in position shown

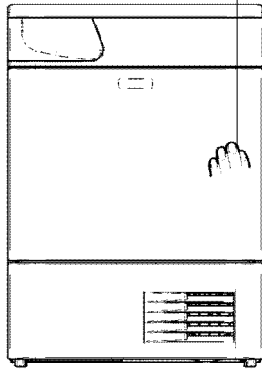

## The features

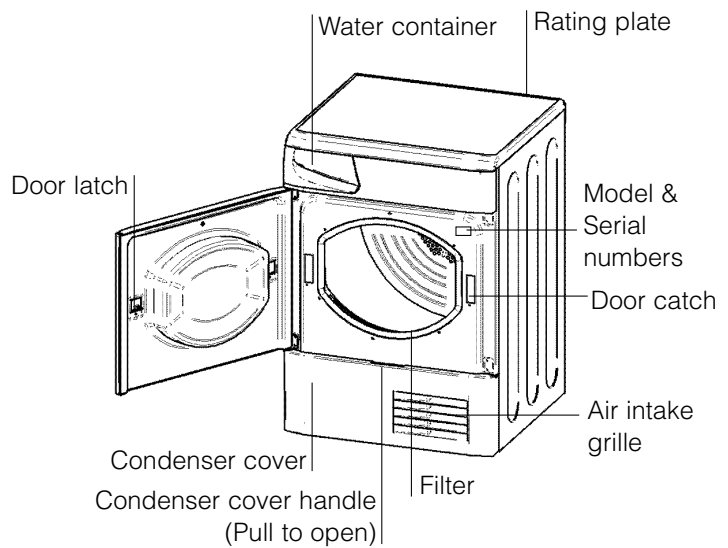

## Control panel

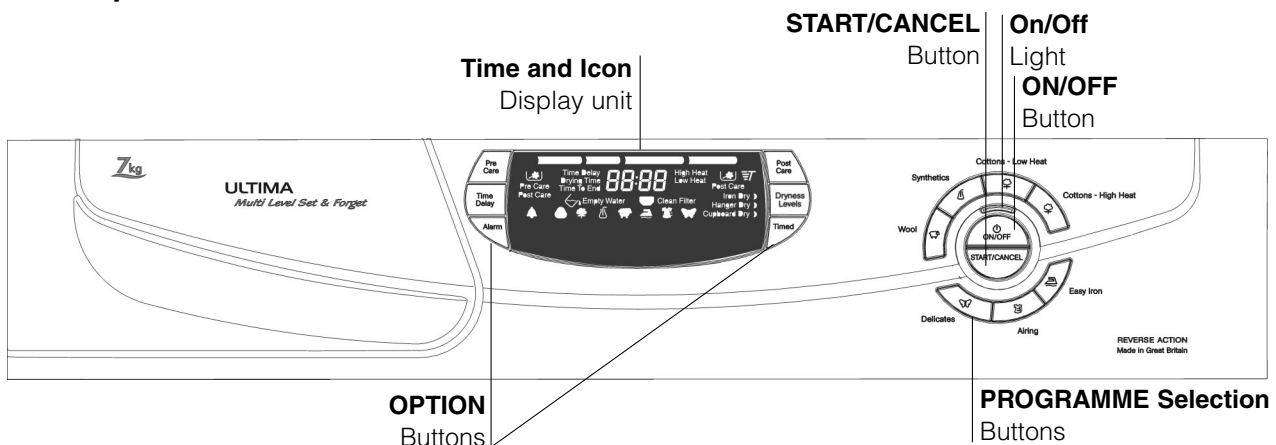

The **START/CANCEL** button starts a selected programme. When you press this button there will be one short beep and the progress icons will flash on/off to confirm the action. If you have not set a programme, the buzzer will beep four times. When a programme is running, holding this button in gives one long beep and cancels the programme and stops the dryer (*see Start and Programmes*).

The **OPTION** buttons/icons: these buttons select available options for your selected programme (*see The Controls*). The icons indicate that the option has been selected.

The **Empty Water** icon  signals that the water container should be emptied. When it is flashing it indicates that the container is full.

The light will take a few seconds to go out after replacing the empty container, the dryer must be running for this to happen (*see The Controls*).

The **Clean Filter** icon  reminds you to clean the filter every time you use the dryer (*see Maintenance*).

The **On/Off** indicator light  signals that your dryer is in use or ready to select a programme.

The **ON/OFF** button : If the dryer is running and this button is pressed, the dryer stops. Press again, the dryer restarts. If you have not opened the door, press START button to continue.

The **Progress** icons :

**PRE CARE** **DRYING** **COOL TUMBLE** **POST CARE** show you the status of the programme. They show each stage of the programme by the corresponding icon turning on (*see Start and Programmes*).

The **PROGRAMME Selection** buttons set the programme: press the button corresponding with the programme you want to select (*see Start and Programmes*).

GB

Installation

Description

Start and Programmes

Laundry

Warnings and Suggestions

Maintenance and Care



Troubleshooting

Service

# Start and Programmes

GB

## Choosing a programme

1. Plug the dryer into the electrical socket.
2. Sort your laundry according to fabric type (*see Laundry*).
3. Open the door and make sure the filter is clean and in place and that the water container is empty and in place (*see Maintenance*).
4. Load the machine and make sure items are not in the way of the door seal. Close the door.
5. If the On/Off light is not lit: Press the ON/OFF button .
6. Press the Programme selection button that corresponds to the fabric type being dried by checking the Programmes table (*see Programmes*) as well as the indications for each type of fabric (*see Laundry*).
7. Choose Timed Drying or Dryness Levels option.
  - If Timed Drying press and release Timed button until the time required is displayed, or...
  - To change from default dryness setting press and release Dryness Levels button until required level is indicated.**!** See Programmes table, for more details.
8. Set a delay time and other options if necessary.
9. If you wish to select the buzzer sound, at the end of the programme, press the ALARM Option button.
10. Press the START button to begin. The display will show the estimated time to end. During the drying programme, you can check on your laundry and take out items that are dry while others continue drying. When you close the door again, press the START button in order to resume drying.
11. During the last few minutes of Drying Programmes, before the programme is completed, the final COOL TUMBLE phase **COOL TUMBLE** is entered (fabrics are cooled), this phase should always be allowed to complete.
12. The buzzer (if Alarm Option was selected) will warn you when the programme is complete and the display shows **End**. Open the door, take the laundry out, clean the filter and replace it. Empty the water container and replace it (*see Maintenance*). If the Post Care  Option has been selected and you do not remove the laundry immediately, the dryer will tumble occasionally for 10 hours or until you open the door.
13. Unplug the dryer.

## Easy Iron Programme

'Easy Iron' is a short 10 minute programme (8 minutes of heat followed by a 2 minute cool tumble period) which fluffs the fibres of clothing that have been left in the same position/location for an extended period of time. The cycle relaxes the fibres and makes them easier to iron and fold.

**!** 'Easy Iron' is **not a drying programme** and should not be used for wet articles of clothing.

For best results:

1. Do not load more than the maximum capacity. These numbers refer to the dry weight:

Fabric	Maximum load
Cotton and Cotton mixtures	2.5kg
Synthetics	2kg
Denim	2kg
2. Unload the dryer immediately after the end of the programme, hang, fold or iron the articles and put them away in the closet. Should this not be possible repeat the programme.

The 'Easy Iron' effect varies from one fabric to the next. It works well on traditional fabrics like Cotton or Cotton mix, and less well on acrylic fibres and on materials such as Tencel®.

## Wool Programme

- This is a programme for tumble dryer safe garments marked with the symbol .
- It can be used for load sizes up to 1kg (approximately 3 sweaters).
- We recommend that garments are turned inside out before drying.
- This programme will take about 20 to 40 minutes, but may take longer depending on the size and density of the load and the spin speed used in your washer.
- Loads dried using this programme are usually ready to wear, but on some heavier garments the edges may be slightly damp. Allow these to dry naturally as over-drying could damage garments.

**!** Unlike other materials, the mechanism of wool shrinkage is irreversible; i.e. it will not stretch back to original size and shape.

**!** This programme is not suitable for Acrylic garments.

# Start and Programmes

## Programmes

! If the On/Off light is not lit; Press the ON/OFF button and then select programme.

Programme	What it does...	How to set it...	Note:
<b>Cottons High Heat</b> 	Dries your Cotton clothes on High heat.	<ol style="list-style-type: none"> <li>1. Press the Cottons - High Heat  button.</li> <li>2. Select Timed Drying or Dryness Levels option. - If Timed Drying, <i>see below</i>, or... - To change from default dryness setting press and release Dryness Levels button until the required level has an indicator next to it.</li> <li>3. Select any Options if required.</li> <li>4. Press the Start button.</li> </ol>	<b>Options available:</b> Alarm , Time Delay, Pre Care , Post Care . <b>Dryness options:</b> Iron Dry Hanger Dry Set & Forget Cupboard Dry  default shown
<b>Cottons Low Heat</b> 	Dries your Cotton clothes on Low heat.	<ol style="list-style-type: none"> <li>1. Press the Cottons - Low Heat  button.</li> <li>2. Select a drying time, <i>see Timed below</i>.</li> </ol>	<b>Options available:</b> <i>See Timed below.</i>
<b>Synthetics</b> 	Dries your Synthetic clothes on High heat.	<ol style="list-style-type: none"> <li>1. Press the Synthetics  button.</li> <li>2. Select Timed Drying or Dryness Levels option. - If Timed Drying, <i>see below</i>, or... - To change from default dryness setting press and release Dryness Levels button until the required level has an indicator next to it.</li> <li>3. Select any Options if required.</li> <li>4. Press the Start button.</li> </ol>	<b>Options available:</b> Alarm , Time Delay, Pre Care , Post Care . <b>Dryness options:</b> Iron Dry Hanger Dry Set & Forget Cupboard Dry  default shown
<b>Wool</b> 	Dries your Woollen clothes, ( <i>see previous page</i> ).	<ol style="list-style-type: none"> <li>1. Press the Wool  button.</li> <li>2. Select any Options if required.</li> <li>3. Press the Start button.</li> </ol>	<b>Options available:</b> Alarm • A Set & Forget programme.
<b>Delicates</b>  (e.g. Acrylics)	Dries your clothes on Low heat setting, ready to be worn.	<ol style="list-style-type: none"> <li>1. Press the Delicates  button.</li> <li>2. If Timed programme required (<i>see Timed below</i>). Otherwise default is Set &amp; Forget.</li> <li>3. Select any Options, if required.</li> <li>4. Press the START button.</li> </ol>	<b>Options available:</b> Alarm , Time Delay, Pre Care , Post Care . • The default is Set & Forget.
<b>Airing</b> 	20-minute programme that airs your clothes with cool air. Use also to cool warm clothes.	<ol style="list-style-type: none"> <li>1. Press the Airing  button.</li> <li>2. Select any Options if required.</li> <li>3. Press the Start button.</li> </ol>	<b>Options available:</b> Alarm
<b>Easy Iron</b> 	Brief programme (approximately 10 minutes) that softens fibres of clothing that is ready for ironing.	<ol style="list-style-type: none"> <li>1. Press the Easy Iron  button.</li> <li>2. Select any Options if required.</li> <li>3. Press the Start button.</li> </ol>	! This is not a drying programme ( <i>see previous page</i> ). <b>Options available:</b> Alarm

## Timed

<b>Timed Drying</b> (0:20, 0:40, 1:00, 1:20, 1:40, 2:00 or 2:20 Hours:Minutes)	Always use Timed Drying for loads less than 1kg, or if you prefer a different dryness result.  The heat setting depends on the material option selected: The display will show LOW HEAT or HIGH HEAT, as appropriate.	<ol style="list-style-type: none"> <li>1. Press and release the Timed button until the display shows the required selection. Each press advances    then <b>OFF</b> and then repeats. • Delicates have maximum time of  .</li> <li>• When <b>OFF</b> is displayed, Set &amp; Forget option is available if you change your mind.</li> <li>3. Select any Options if required.</li> <li>4. Press the Start button.</li> </ol>	<b>Options available:</b> Alarm , Time Delay, Pre Care , Post Care .  Consult suggested drying times ( <i>see Laundry</i> ).  The last 10 minutes of these programmes is the Cool Tumble phase.
---	---	---	--

GB
Installation
Description
Start and Programmes
Laundry
Warnings and Suggestions
Maintenance and Care
Troubleshooting
Service

# Start and Programmes

GB

## The Controls

**! Warning**, if after pressing the start button, the programme cannot be changed.

**! ON/OFF**  button : press this button and you pause the programme. Press it again and the programme will resume, if you have opened the door you will need to press the Start button first to resume the programme.





**! START/CANCEL** button : press and hold in this button and you cancel a programme, the display then shows .

### • Option buttons / icons

These buttons are used to customise the selected programme to your requirements. A programme must have been selected, by pressing a programme selection button, before an option can be selected. Not all options are available for all programmes (*see Start and Programmes*). If an option is not available and you press the button, the buzzer will beep four times. If the option is available there will be one beep and the option icon lights to confirm the selection.

#### Time Delay

The start of some programmes (*see Start and Programmes*) can be delayed for up to 18 hours. Ensure the water container is emptied before setting a delayed start.

To set, press the Time Delay button, the display shows  and the option TIME DELAY icon comes on. Press again and a 1 hour delay is selected and the display shows , each further press of the button adds 1hr to the delay. When  is displayed a further press the display shows  and after a couple of seconds cancels the delay.

#### Pre Care

This option is only available if a delayed start has been selected. It tumbles the clothes occasionally during the delayed period to help prevent creases developing.

#### Alarm

Available on all programmes and allows the buzzer to give a signal at the end of the drying cycle, to remind you that the clothes are ready to be removed. Press the button and the icon will show that the option is selected.

#### Post Care

When available and selected, the clothes are occasionally tumbled after the end of the drying and cool tumble cycles, to help prevent creases developing should you not be available to remove the load immediately the programme is complete.

### • TIME DISPLAY

The display shows either the amount of time delay remaining or an indication of the amount of time left for a drying programme.

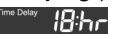
 The delay time is displayed in hours and counts down each hour. The TIME DELAY icon flashes after the start button has been pressed.

 The time to end is displayed in hours and minutes and counts down each minute, this includes the cool tumble phase, the heat setting HIGH or LOW is also shown.

 When timed programmes are selected the time displayed throughout the cycle is the actual time remaining.

When a Set & Forget programme is selected, the time displayed is an estimate of the time remaining. When the programme is selected the display shows the time required to dry a full load, after around 10 minutes the controller calculates a better estimate of the cycle time. The colons between the hours and minutes in the display flash to show that the time is counting down. When the programme finishes its cool tumble phase the display will show .

The display also shows if there is a problem with your dryer, if this occurs the display will show F followed by a fault code number (*see Troubleshooting*).

### • Empty Water Icon / Container

(If you have plumbed your dryer to a drain this icon can be ignored, as there is no need to empty the water container).

When this icon is on (not flashing) it reminds you to empty the water container.

If the water container fills during a programme, the heater turns off and the dryer does a period of Cool Tumble then the icon flashes and the buzzer sounds. After this it stops and all progress icons come on and the empty water icon flashes.

You must empty the water container and restart the dryer or the clothes will not dry. After re-starting the dryer the icon will take a few seconds to go out.

To avoid this always empty the water container each time you use the dryer (*see Maintenance*).

### • Door Opening

Opening the door during a programme will stop the dryer and have the following effects:

- All 4 progress icons come on.
- During a delay phase the delay will continue to count down. The start button **must** be pressed to resume the delay programme. The progress icons will change to show current status.
- During the drying part of the programme, the colons on the display stop flashing to show that the time has stopped counting down. The start button **must** be pressed to resume the programme. The progress icons will change to show the current status, the colons flash and count down continues.
- During an Airing or Cool Tumble programme, or Post Care phase, the programme ends and the display shows .

### • Note

If you have a power cut, switch off the power or remove the plug, press the START button and the programme will resume.



## Sorting your laundry

- Check symbols on clothing labels to make sure that the articles can be tumble dried.
- Sort laundry by fabric type.
- Empty pockets and check buttons.
- Close zippers and hooks and tie loose belts and strings.
- Wring out each item in order to eliminate as much excess water as possible.

! Do not load dripping wet clothes into the dryer.

### Maximum load size

Do not load more than maximum capacity.

These numbers refer to dry weight:

Natural fibres: 7kg max (15lb)

Synthetic fibres: 3kg max (6.6lb)

! DO NOT overload the dryer as this could result in reduced drying performance.





### Typical load

Clothes			
Blouse	Cotton	150g	5oz
	Other	100g	3oz
Dress	Cotton	500g	1lb 2oz
	Other	350g	12oz
Jeans		700g	1lb 6oz
10 nappies		1000g	2lb 3oz
Shirt	Cotton	300g	10oz
	Other	200g	7oz
T-Shirt		125g	4oz
Household Items			
Duvet cover (Double)	Cotton	1500g	3lb 5oz
	Other	1000g	2lb3oz
Large Tablecloth		700g	1lb 6oz
Small Tablecloth		250g	9oz
Tea Towel		100g	3oz
Bath Towel		700g	1lb 6oz
Hand Towel		350g	12oz
Double Sheet		500g	1lb 2oz
Single Sheet		350g	12oz

At the end of a drying cycle, cottons could still be damp if you grouped cottons and synthetics together. If this happens simply give them an additional short period of drying.

## Wash Care Labels

Look at the labels on your garments, especially when tumble drying for the first time. The following symbols are the most common:

-  May be tumble dried
-  Do **not** tumble dry
-  Tumble dry at high heat setting
-  Tumble dry at low heat setting

### Items not suitable for tumble drying

- Articles that containing rubber or rubber-like materials or plastic film (pillows, cushions, or PVC rainwear), any other flammable articles or objects that contain flammable substances (towels soiled with hair spray).
- Glass fibres (certain types of draperies)
- Items which have been dry cleaned
- Items with the ITCL Code  (*see Special clothing items*). These can be cleaned with special at-home dry cleaning products. Follow instructions carefully.
- Large bulky items (quilts, sleeping bags, pillows, cushions, large bedspreads etc). These expand when drying and would prevent airflow through the dryer.

GB

Installation

Description

Start and Programmes

Laundry

Warnings and Suggestions

Maintenance and Care

Troubleshooting

Service

# Laundry

GB

## Special clothing items

**Blankets and Bedspreads:** acrylic items (Acilan, Courtelle, Orion, Dralon) **must be dried** with special care on LOW heat setting. Avoid drying for a long period of time.

**Pleated or creased garments:** read the manufacturer's drying instructions on the garment.

**Starched articles:** do not dry these with non-starched items. Make sure that as much of the starch solution is removed from the load as possible before placing it in the dryer. Do not over-dry: the starch will become powdery and leave your clothing limp, which defeats the purpose of starch.

## Drying times

Times are approximate and can vary depending upon:

- Amount of water retained in clothes after spin cycle: towels and delicates retain a lot of water.
- Fabrics: items that are the same type of fabric but different textures and thicknesses may not have the same drying time.
- Quantity of laundry: single items or small loads may take longer to dry.

- Dryness: If you are going to iron some of your clothes, they can be taken out while still a bit damp. Others can be left longer if you need them to be completely dry.
- Heat setting.
- Room temperature: if the room where the dryer is located is cold, it will take longer for the dryer to dry your clothes.
- Bulk: some bulky items can be tumble dried with care. We suggest that you remove these items several times, shake them out, and return them to the dryer until finished.

**!** Do not over-dry your clothes.



All fabrics contain a little natural moisture, which keeps them soft and fluffy.

The table below presents APPROXIMATE drying times in Hours : Minutes, as you see them on the display, the times are also shown in Minutes only for reference.

The times given are for Cupboard Dry Set & Forget programmes.

Timed Dry settings are also shown, to help you choose a suitable option.

Weights refer to dry garments.

<b>Cottons</b> 				Half Load				Full Load	
		1 kg	2 kg	3 kg	4 kg	5 kg	6 kg	7 kg	
	<b>High Heat</b>	Set & Forget duration	0:30 - 0:40	0:40 - 0:55	0:55 - 1:10	1:10 - 1:20	1:20 - 1:30	1:35 - 2:00	2:00 - 2:20
		Set & Forget minutes	30 - 40	40 - 55	55 - 70	70 - 80	80 - 90	95 - 120	120 - 140
		Timed Dry setting	0:20 or 0:40	0:40 or 1:00	1:00 or 1:20	1:00 or 1:20	1:20 or 1:40	1:40 or 2:00	2:00 or 2:20
Drying times 800-1000 rpm in washing machine.									
<b>Synthetics</b> 				Half Load				Full Load	
		1 kg		2 kg				3 kg	
	<b>High Heat</b>	Set & Forget duration	0:40 - 0:50		0:50 - 1:10			1:10 - 1:30	
		Set & Forget minutes	40 - 50		50 - 70			70 - 90	
		Timed Dry setting	0:40 or 1:00		0:40 or 1:20			1:00 or 1:20 or 1:40	
Drying times on reduced spin in washing machine.									
<b>Delicates</b> (Acrylics) 				Half Load				Full Load	
		1 kg		2 kg					
	<b>Low Heat</b>	Set & Forget duration	0:40 - 1:20					1:20 - 1:40	
		Set & Forget minutes	40 - 80					80 - 100	
		Timed Dry setting	0:40 or 1:00 or 1:20					1:20 or 1:40	
Drying times on reduced spin in washing machine.									

# Warnings and Suggestions

! The appliance has been designed and built according to international safety standards. These warnings are given for safety reasons and must be read carefully.

**CE** This appliance conforms to the following EEC Directives:  
 - 72/23/EEC and 93/68/EEC (Low Voltage Equipment)  
 - 89/336/EEC, 92/31/EEC and 93/68/EEC (Electromagnetic Compatibility)

## General safety

- This tumble dryer has been designed for home, and not professional use.
- This dryer must be used by adults, and the instructions in this booklet should be followed carefully.
- Do not touch the appliance while barefoot or with wet hands or feet.
- Unplug the machine by pulling on the plug, not the cord.
- Children must not be in proximity of the dryer when in use. After using the dryer, turn it off and unplug it. Keep the door closed to make sure that children do not use it as a toy.
- The appliance must be installed correctly and have proper ventilation. The air intake at the front of the dryer and rear vent behind the dryer should never be obstructed (*see Installation*).
- Never use the dryer on carpeting where the pile height would prevent air from entering the dryer from the base.
- Check to see if the dryer is empty before loading it.
-  The back of the dryer could become very hot. Never touch it while in use.
- Do not use the dryer unless the filter, water container and condenser are securely in place (*see Maintenance*).
- Do not use liquid fabric softeners in the dryer, add it to the final rinse of your wash.
- Do not overload the dryer (*see Laundry* for maximum loads).
- Do not load items that are dripping wet.
- Tumble dry items only if they have been washed with detergent and water, rinsed and been through the spin cycle. It is a fire hazard to dry items that HAVE NOT been washed with water.
- Carefully check all instructions on clothing labels (*see Laundry*).
- Do not dry garments that have been treated with chemical products.
- Never dry articles that are contaminated with flammable substances (petrol, oil, paint, hair spray, creams, cooking fat or oils).
- Do not tumble dry rubber, foam rubber, plastic, plastic foam, nappy pants or liners, polythene or paper.
- Do not tumble dry large, very bulky items.
- Do not tumble dry acrylic fibres at high temperatures.

- Complete each programme with its Cool Tumble Phase.
- Do not turn off the dryer when there are still warm items inside.
- Clean the filter after each use (*see Maintenance*).
- Empty the water container after each use (*see Maintenance*).
- Clean the condenser unit after regular intervals (*see Maintenance*).
- Do not allow lint to collect around the dryer.
- Never climb on top of the dryer. It could result in damage.
- Always follow electrical standards and requirements (*see Installation*).
- Always buy original spare parts and accessories (*see Service*).

## Recycling and disposal information



As part of our continued commitment to helping the environment, we reserve the right to use quality recycled components to keep down customer costs and minimise material wastage.

- Disposing of the packaging material: follow local regulations, so the packaging can be recycled.
- To minimise risk of injury to children, remove the door and plug - then cut off mains cable, flush with the appliance. Dispose of these parts separately to ensure that the appliance can no longer be plugged into a mains socket.

## Disposal of old electrical appliances

The European Directive 2002/96/EC on Waste Electrical and Electronic Equipment (WEEE), requires that old household electrical appliances must not be disposed of in the normal unsorted municipal waste stream. Old appliances must be collected separately in order to optimise the recovery and recycling of the materials they contain and reduce the impact on human health and the environment.



The crossed out "wheeled bin" symbol on the product reminds you of your obligation, that when you dispose of the appliance it must be separately collected.

Consumers should contact their local authority or retailer for information concerning the correct disposal of their old appliance.

## Saving energy and respecting the environment

- Wring out items to eliminate excess water before tumble drying (if you use a washing machine first, select a high spin cycle). Doing this will save time and energy during drying.
- Always dry full loads - you save energy: single items or small loads take longer to dry.
- Clean the filter after each use to contain energy consumption costs (*see Maintenance*).

GB
Installation
Description
Start and Programmes
Laundry
Warnings and Suggestions
Maintenance and Care
Troubleshooting
Service

# Maintenance and Care

GB

## Switching off the electricity

! Unplug your dryer when not using it, when cleaning it and during all maintenance operations.

## Clean the filter after each cycle

The filter is an important part of your dryer: it accumulates lint and fluff that is formed while drying. When finished drying, clean the filter by rinsing it under running water or with your vacuum cleaner. Should the filter become clogged up, the airflow inside the dryer will be seriously compromised: drying times lengthen and you will consume more energy. It may also damage your dryer.

The filter is found in front of the dryer trim (*see diagram*). Removing the filter:

1. Pull the plastic grip of the filter upwards (*see diagram*).
2. Clean the filter and replace it correctly.  
Ensure the filter is fully located flush into the tumble dryer trim.

! Do not use the dryer without replacing the filter.

## Empty the water container after each cycle

Pull the container out of the dryer and empty it into a sink or other suitable drain.

Replace the water container securely.

Always check and empty the container before you start a new drying programme.

## Check the drum after each cycle

Turn the drum manually in order to remove small items (handkerchiefs) that could have been left behind.

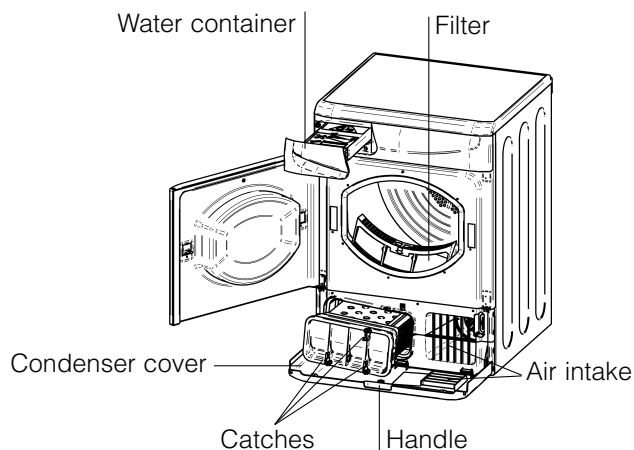

## Cleaning the drum

! Do not use abrasives, steel wool or stainless steel cleaning agents to clean the drum.

A coloured film may start to appear on the stainless steel drum, this may be caused by a combination of water and, or cleaning agents such as fabric conditioner from the wash. This coloured film will not affect the dryer performance.

## Cleaning the condenser unit

Periodically (every month) remove the condenser unit and clean any build up of fluff from between the plates by rinsing it under the tap with cold water.

This should be done with cold water from the rear of the condenser.

Removing the condenser:

1. Unplug the dryer and open the door.
2. Pull open the condenser cover (*see diagram*).  
Release the three catches by turning 90° counter-clockwise then pull on the grip and remove from the dryer.
3. Clean the surface of the seals and replace, making sure that the catches have been secured.

## Cleaning the dryer

- External parts in metal or plastic and rubber parts can be cleaned with a damp cloth.
- Periodically (every 6 months) vacuum the front air intake grille and vents at the rear of the dryer, to remove any build up of fluff, lint or dust. Also to remove accumulation of fluff from the front of the condenser and filter areas, clean occasionally with a vacuum cleaner.

! Do not use solvents or abrasives.

! Your dryer uses special bearing components which do not need lubrication.

! Have your dryer checked regularly by authorised technicians to ensure electrical and mechanical safety (*see Service*).

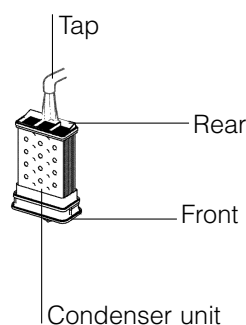

One day your dryer seems not to be working. Before you call your Service Centre (*see Service*), go through the following troubleshooting suggestions:

**Problem:**

**Possible causes / Solution:**

**The tumble dryer won't start.**

- The plug is not plugged into the socket, or not making contact.
- There has been a power failure.
- The fuse has blown. Try to plug another appliance into the socket.
- You are using an extension cord? Try to plug the dryer's power cord directly into the socket.
- The door is not closed securely?
- The programme has not been set properly (*see Start and Programmes*).
- The START button has not been pressed (*see Start and Programmes*).

**Drying cycle will not begin.**

- You have set a delayed time (*see Start and Programmes*).

**Its taking a long time to dry.**

- The filter has not been cleaned (*see Maintenance*).
- The temperature setting is not ideal for the type of fabric you are drying (*see Start and Programmes, and see Laundry*).
- The water container needs emptying? The empty water icon is flashing? (*see Maintenance*).
- The condenser needs cleaning? (*see Maintenance*).
- The correct drying time has not been selected for the load (*see Laundry*).
- The air intake grille or rear vents are obstructed (*see Installation, and see Maintenance*).
- The items were too wet (*see Laundry*).
- The dryer was overloaded (*see Laundry*).

**Empty water icon is flashing but the dryer has only been running for a short period.**

- The water container was probably not emptied at the start of the programme. Do not wait for the empty water signal, always check and empty the container before starting a new drying programme (*see Maintenance*).

**Empty water icon is on and the water container is not full.**

- This is normal, the icon flashes when the container is full. If the icon is on but not flashing it is just a reminder to empty the container (*see Start and Programmes*).

**Programme finishes and clothes are damper than expected.**

- ! For safety the dryer has a maximum programme time of 3 hours. If an automatic programme has not sensed the required final moisture in this time the dryer will complete the programme and stop. Check the above points and run the programme again, if the results are still damp, contact the Service Centre (*see Service*).

**The display shows a fault code F followed by one or two numbers**

- If the display shows F10 or F15:
  - Turn off and remove the plug. Clean the filter and the condenser (*see Maintenance*). Then replace the plug, turn on and start another programme. If F10 or F15 is still displayed contact the Service Centre (*see Service*).
- If any other number is shown: Note down the code and contact the Service Centre (*see Service*).

<b>GB</b>
Installation
Description
Start and Programmes
Laundry
Warnings and Suggestions
Maintenance and Care
Troubleshooting
Service

## Before calling the Service Centre:

- Use the troubleshooting guide to see if you can solve the problem yourself (*see Troubleshooting*).
- If not, turn off the dryer and call the Service Centre closest to you.

### What to tell the Service Centre:

- name, address and post code.
- telephone number.
- the type of problem.
- the date of purchase.
- the appliance model (Mod.).
- the serial number (S/N).

This information can be found on the data label inside the door of the machine.

## Spare Parts



This dryer is a complex machine. Repairing it yourself or having a non-authorized person try to repair it could cause harm to one or more persons, could damage the machine and could invalidate the spare parts warranty.

Call an authorised technician if you experience problems while using the machine.

The spare parts have been designed exclusively for this appliance and not for other uses.

# Comparative Programmes

- Programmes recommended for comparative test to EN61121

Programme (EN61121)	Programme to select	Load size	Dryness Option
Dry Cotton	Cottons High Heat 	7 kg	Hanger Dry
Iron Dry Cotton	Cottons High Heat 	7 kg	Iron Dry
Easy-care textile	Synthetics 	3 kg	Cupboard Dry

! Note: This is not a full list of programme options (*see Start and Programmes*).





195042646.04 W

02/2006 - SIMLEX . Four Ashes, Wolverhampton

## Key Contacts

### After Sales Service

Over 1100 trained specialists, directly employed by us, ensure that you can have complete confidence in both the appliances and services we offer.

### Repair Service and Information Help Desk

UK: 08709 066 066

Monday to Friday, 8am to 7.30pm

Saturday, 8.30am to 5.30pm

Sunday, 9.30am to 3.30pm

[www.hotpointservice.co.uk](http://www.hotpointservice.co.uk)

Republic of Ireland: 1850 302 200

Note: Our operators will require the following information:

Model number

Serial number

### Extended Warranties

UK: 08709 088 088

Monday to Sunday, 8am to 8pm

[www.hotpointservice.co.uk](http://www.hotpointservice.co.uk)

Republic of Ireland: 1850 502 200

### Genuine Parts and Accessories

UK: 08709 077 077

Monday to Friday, 8.30am to 5pm

Saturday, 8.30am to 12noon

[www.hotpointservice.co.uk](http://www.hotpointservice.co.uk)

Republic of Ireland: (01) 842 6836

[www.hotpoint.co.uk](http://www.hotpoint.co.uk)