





Models: DDSR475ET DWXR473ET
DDSR475GT DWXR473GT

Dryer

Owner's Manual

	Important Safety Information	3
---	-------------------------------------	----------

	Operating Instructions <i>The Controls on Your Dryer</i> <i>Other Dryer Features</i>	8
--	---	----------

	Helpful Information <i>Specialized Fabric Guide</i> <i>Loading Suggestions</i> <i>Care of Product</i>	13
---	---	-----------

	If Something Goes Wrong <i>Before You Call For Service</i> <i>Venting the Dryer</i> <i>GE Service Numbers</i> <i>Warranty, Back Cover</i>	17
---	--	-----------

GE Answer Center®
800.626.2000

GE Appliances

Welcome

Welcome to the GE family. We're proud of our quality products and we believe in dependable service. You'll see it in this easy-to-use manual and you'll hear it in the friendly voices of our customer service department.

Best of all, you'll experience these values each time you do the laundry. That's important, because your new dryer will be part of your family for a long time.

Start Here!

*Before
using
your
dryer*

Staple your receipt to the inside back cover of this manual.

Find your model. Put a check mark in the box identifying your model in the section titled, "Operating Instructions." This will provide easy access for your operating instructions.

Write down the model and serial numbers here. They are on the label on the front of the dryer behind the door.

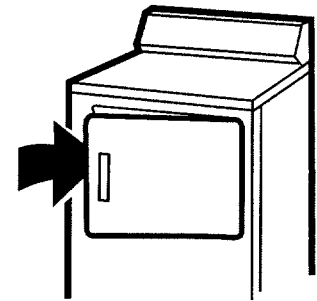

Model number

Serial number

Date of purchase

Need Help?

*Help us
help you*

Before you call for service, there are a few things you can do to help us serve you better.

Read this manual. It contains instructions to help you use and maintain your dryer properly.

Save time and money. Check the section titled "If Something Goes Wrong" before calling. This section was designed to solve common problems you might encounter.

If you do need service, you can relax knowing help is only a phone call away. A list of toll-free customer service numbers is included on the inside back cover. Or call the GE Answer Center[®] at 800.626.2000, 24 hours a day, 7 days a week.

Para obtener la versión en español de este manual, llame a GE Answer Center[®], servicio de información para el consumidor, teléfono 800.626.2000.

800.626.2000

Important Safety Information



Read all safety information before using

! WARNING: For your safety the information in this manual must be followed to minimize the risk of fire or explosion or to prevent property damage, personal injury or loss of life.

Do not store or use gasoline or other flammable vapors and liquids in the vicinity of this or any other appliance.

Installation and service must be performed by a qualified installer, service agency or the gas supplier.

IF YOU SMELL GAS

- 1** Do not try to light any appliance.
- 2** Do not touch any electrical switch; do not use any phone in your building.
- 3** Clear the room, building or area of all occupants.
- 4** Immediately call your gas supplier from a neighbor's phone. Follow the gas supplier's instructions.
- 5** If you cannot reach your gas supplier, call the fire department.

! California Safe Drinking Water and Toxic Enforcement Act

This act requires the governor of California to publish a list of substances known to the state to cause cancer, birth defects or other reproductive harm and requires businesses to warn customers of potential exposure to such substances.

Gas appliances can cause minor exposure to four of these substances, namely benzene, carbon monoxide, formaldehyde and soot, caused primarily by the incomplete combustion of natural gas or LP fuels.

Properly adjusted dryers will minimize incomplete combustion. Exposure to these substances can be minimized further by properly venting the dryer to the outdoors.



Important Safety Information

Read all safety information before using



Warning

To reduce the risk of fire, electric shock, or injury to persons when using your appliance, follow basic precautions, including the following sections.

Safety Precautions

- Use this appliance only for its intended purpose as described in this Owner's Manual.
- This dryer must be properly installed and located in accordance with the Installation Instructions before it is used. If you did not receive an Installation Instructions sheet with your dryer, you can obtain one by calling, toll free, the GE Answer Center[®], 800.626.2000.
 - Properly ground to conform with all governing codes and ordinances. Follow details in Installation Instructions.
 - Install or store where the temperature is above 50°F. (10°C.). Do not install the dryer where it will be exposed to the weather.
 - Connect to a properly rated, protected and sized power supply circuit to avoid electrical overload.
 - Gas dryers **MUST** be exhausted to the outside. Carefully follow the Exhausting details in the Installation Instructions.
 - Exhausting electric dryers to the outside is **STRONGLY RECOMMENDED** to prevent large amounts of moisture and lint from being blown into the room. Carefully follow the Exhausting details in the Installation Instructions.
- Do not repair or replace any part of the appliance or attempt any servicing unless specifically recommended in this Owner's Manual or in published user-repair instructions that you understand and have the skills to carry out.
- When disconnecting this appliance pull by the plug rather than the cord to avoid damage to the cord or junction of cord and plug. Make sure that the cord is located so that it will not be stepped on, tripped over or otherwise subjected to damage or stress.



- Exhaust Duct—See Installation Instructions. Use only rigid metal or flexible metal 4" diameter ductwork inside the dryer cabinet or for exhausting to the outside. **USE OF PLASTIC OR OTHER COMBUSTIBLE DUCTWORK CAN CAUSE A FIRE. PUNCTURED DUCTWORK CAN CAUSE A FIRE IF IT COLLAPSES OR BECOMES OTHERWISE RESTRICTED IN USE OR DURING INSTALLATION.**
- Do not dry articles containing rubber, plastic, or similar materials (such as padded bras, tennis shoes, galoshes, bath mats, rugs, bibs, baby pants, plastic bags, pillows, etc.) as these materials may melt or burn. Also, some rubber materials, when heated, can under certain circumstances produce fire by spontaneous combustion.
- Do not store items that may burn or melt (such as clothing, paper material, plastics or plastic containers, etc.) on top of the dryer during operation.
- Garments labeled "Dry Away from Heat" or "Do not Tumble Dry" (such as life jackets containing Kapok) must not be put in your dryer.
- Do not wash or dry articles that have been cleaned in, washed in, soaked in, or spotted with combustible or explosive substances (such as wax, paint, oil, gasoline, degreasers, dry-cleaning solvents, kerosene, etc.) which may ignite or explode. Do not add these substances to the wash water. Do not use these substances around your washer and/or dryer during operation.
- Any article on which you have used a cleaning solvent, or which contains flammable materials (such as cleaning cloths, mops, towels used in beauty salons, restaurants, or barber shops, etc.) must not be placed in or near the dryer until all traces of these flammable liquids or solids and their fumes have been removed. There are many highly flammable items used in homes such as acetone, denatured alcohol, gasoline, kerosene, some household cleaners, some spot removers, turpentine, waxes, wax removers and products containing petroleum distillates.



Important Safety Information

Read all safety information before using

- Clean the lint filter before each load to prevent lint accumulation inside the dryer or in the room. **DO NOT OPERATE THE DRYER WITHOUT THE LINT FILTER IN PLACE.**
- Keep the area around and underneath your appliances free from the accumulation of combustible materials, such as lint, paper, rags, chemicals, etc.
- The interior of the machine and the exhaust duct connection inside the dryer should be cleaned periodically by a qualified individual.
- Never reach into the dryer while the drum is moving. Before loading, unloading or adding clothes, wait until the drum has completely stopped.
- Do not dry fiberglass articles in your dryer. Skin irritation could result from the remaining glass particles that may be picked up by clothing during subsequent dryer uses.
- The laundry process can reduce the flame retardancy of fabrics. To avoid such a result, the garment manufacturer's care instructions should be followed very carefully.
- Close supervision is necessary if this appliance is used by or near children. Do not allow children to play inside, on, or with this appliance or any discarded appliance. Dispose of discarded appliances and shipping or packing materials properly. Before discarding a dryer, or removing from service, remove the door of the dryer compartment.
- Keep all laundry aids (such as detergents, bleaches, fabric softeners, etc.) out of the reach of children, preferably in a locked cabinet. Observe all warnings on container labels to avoid personal injury.
- Keep the floor around your appliances clean and dry to reduce the possibility of slipping.
- To minimize the possibility of electric shock, unplug this appliance from the power supply or disconnect the dryer at the household distribution panel by removing the fuse or switching off the circuit breaker before attempting any maintenance or cleaning (except the removal and cleaning of the lint filter).
- **NOTE:** Turning the Cycle Selector knob to an OFF position does NOT disconnect the appliance from the power supply.



- Do not tamper with the controls.
 - Do not operate this appliance if it is damaged, malfunctioning, partially disassembled, or has missing or broken parts, including a damaged cord or plug.
 - Never climb on or stand on the dryer top.
 - If yours is a gas dryer, it is equipped with an automatic electric ignition and does not have a pilot light. **DO NOT ATTEMPT TO LIGHT WITH A MATCH.** Burns may result from having your hand in the vicinity of the burner when the automatic ignition may turn on.
 - You may wish to soften your laundered fabrics or reduce the static electricity in them by using dryer-applied fabric softeners or an anti-static conditioner. We recommend you use either a fabric softener in the wash cycle, according to the manufacturer's instructions for those products, or try a dryer-added product for which the manufacturer gives written assurance on the package that their product can be safely used in your dryer.
- Service or performance problems caused by the use of these products are the responsibility of the manufacturers of those products and are not covered under the warranty of this appliance.

SAVE THESE INSTRUCTIONS

Operating Instructions

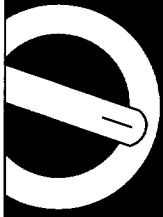

Find your model Put a check mark in the box next to your model number. (To locate your model number look on the label on the front of the dryer behind the door.)



The controls on your dryer

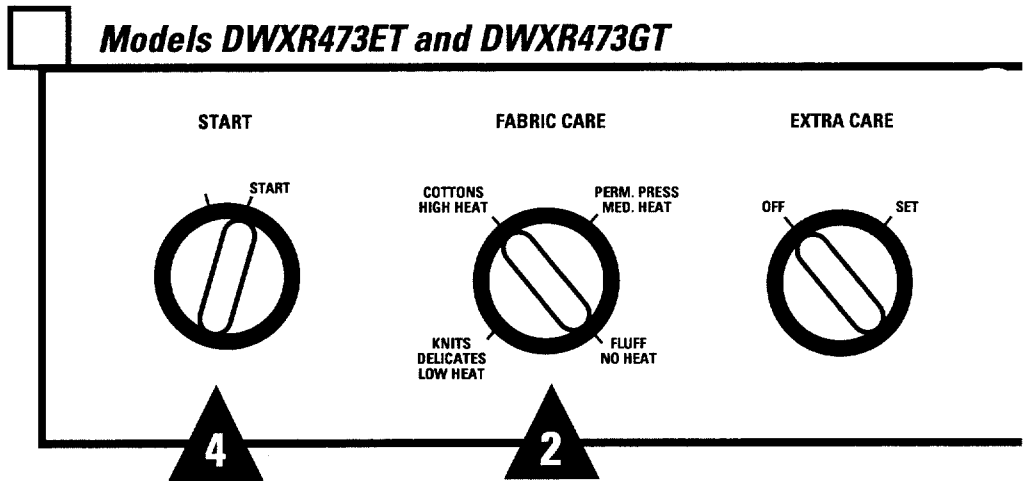
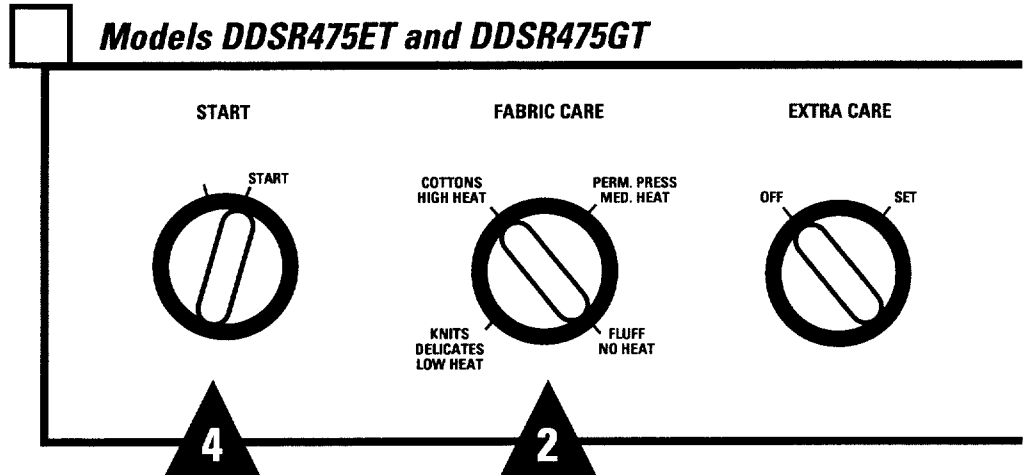

1 Clean the Lint Filter

Clean the lint filter each time you use the dryer.

CAUTION:

Do not operate the dryer without the lint filter in place.

2 Fabric Care Selections

Always follow Fabric Manufacturer's Care Label or instructions when laundering. Use this chart as a general guide.

Drying Selections	Usage
Cottons/High Heat	For regular to heavy cottons.
Perm. Press/Med. Heat	For synthetics, blends and items labeled "permanent press."
Knits Delicates/Low Heat	For delicates, synthetics and items labeled "tumble dry low."
Fluff/No Heat	For "fluffing" items without heat. Use the Timed Dry cycle.

Cycle Descriptions



Automatic Drying Cycles

Cycles automatically sense dryness

Automatic Permanent Press

For synthetic blends and delicates. Select **More Dry** for heavier loads, **Less Dry** for lighter loads.

Automatic Cottons

For cottons and most linens. For most normal loads select the Preferred Regular Setting*. Set towards **More Dry** for heavier and wetter fabrics, **Less Dry** for lighter fabrics.

Timed Dry Cycles

Cycles run for a selected time

Timed Dry

Set the Cycle Selector at the desired drying time.

Damp Dry

To leave items partially dry set Cycle Selector on Damp Dry setting.

Dewrinkle

For removing wrinkles from items that are clean and dry or that are very lightly damp. Set the Cycle Selector on the Dewrinkle setting.

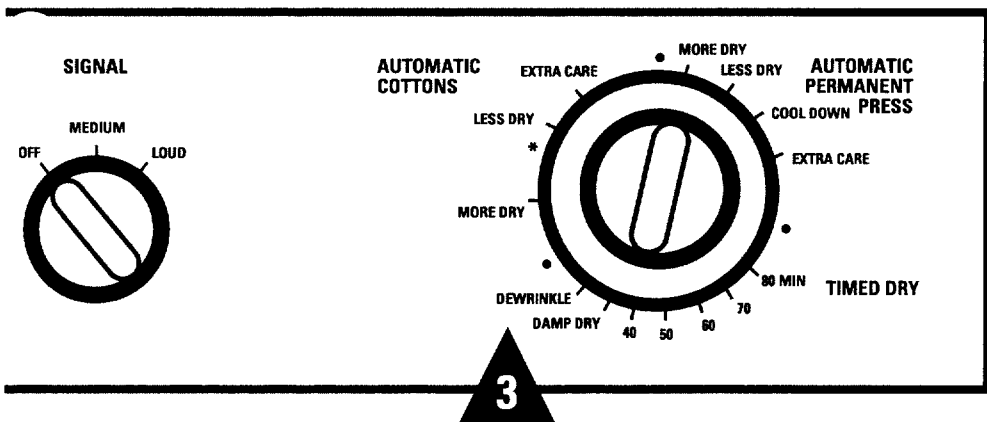
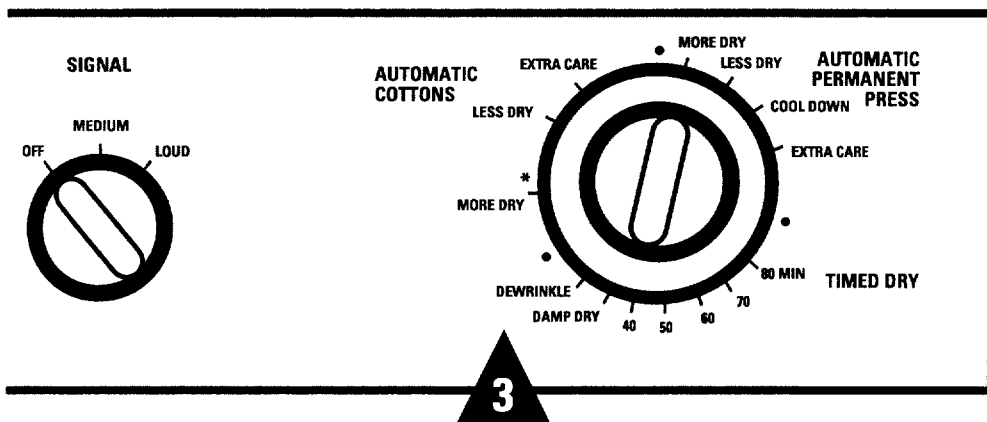

NOTE:

Drying times will vary according to the type of heat used (Electric, Natural or LP gas), size of load, types of fabrics, wetness of clothes and condition of exhaust ducts.

3 Selecting Drying Cycle

Select an automatic or timed cycle. See the above Cycle Descriptions.

4 Starting Dryer

- Close the dryer door.
- Select START.

Opening the door during the operation will stop the dryer. To restart the dryer, close the door and select START to complete the cycle.

See next page for other dryer features



Operating Instructions

Other dryer features your model may have

Extra Care

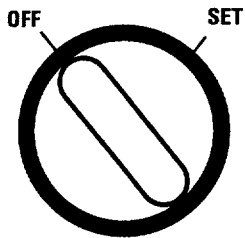

Use this option to minimize the wrinkles in clothes. The option provides approximately 15 minutes of no-heat tumbling after the clothes are dry.

This option can only be used with the Automatic cycles.

HINT:

If the Signal option is selected, the Signal will sound at the end of the drying time and will sound several times during the Extra Care cycle. This will remind you that the cycle is almost complete.

Signal

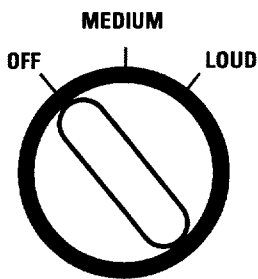

The signal control can be set at OFF, MEDIUM or LOUD.

This signal will sound just before the end of the cycle to remind you to remove the clothes.

If you selected the Extra Care option the signal will sound at the end of the drying time and will sound several times during the Extra Care cycle. This will remind you that the cycle is almost complete.

NOTE:

- ***Remove garments promptly at the sound of the signal. Place clothes on hangers so wrinkles won't set in.***
- ***Use the Signal especially when drying fabrics like polyester knits and permanent press. These fabrics should be removed promptly so wrinkles won't set in.***



Drum Lamp

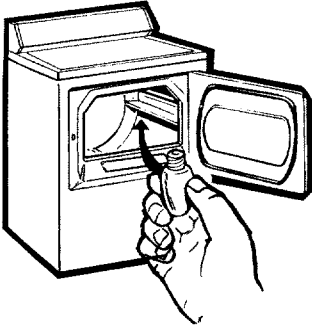

Before replacing the light bulb, be sure to unplug the dryer power cord or disconnect the dryer at the household distribution panel by removing the fuse or switching off at the circuit breaker. Reach above dryer opening from inside the drum. Remove the bulb and replace with the same size bulb.

Drying Rack

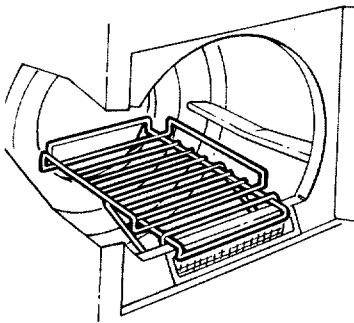

A handy drying rack may be used for drying articles such as stuffed toys, pillows or washable sweaters. Hook the rack over the lint filter so the rack extends into the dryer drum.

NOTE:

- ***The drying rack must be used with the Timed Cycle.***
- ***Do not use this drying rack when there are other clothes in the dryer.***



Operating Instructions

Reversing the Door

Tools Needed:

- **Standard # 2 Phillips screwdriver**
- **Tape-tipped putty knife**
- **Needle-nosed pliers**

- 1** Open the door and remove the filler plugs opposite the hinges.
- 2** With the door completely open, remove the bottom screw from each hinge on the dryer face.

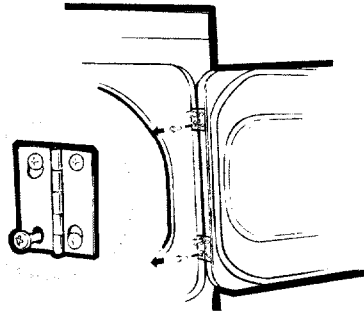

- 3** Insert these screws about half way into the TOP holes, for each hinge, on the opposite side. (Where you removed the filler plugs.) Apply firm pressure to get the screw started in untapped holes.
- 4** Loosen the top screw from each hinge on the dryer face half way.

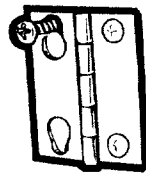

- 5** With one hand holding the top of the door and the other hand holding the bottom, remove the door from the dryer by lifting it UP and OUT.

- 6** Rotate the door 180°. Insert it on the opposite side of the opening by moving the door IN and DOWN until the top hinge and the bottom hinge are resting on the top screws inserted in step 3.

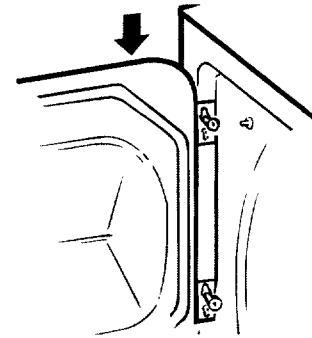

- 7** Remove the remaining screws from the side of the opening from which the door was removed. With these screws secure each hinge at the bottom.

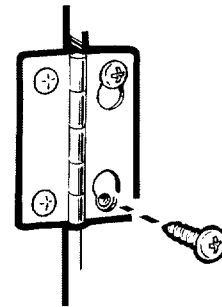

- 8** Tighten the two top screws of each hinge.
- 9** Reinsert the plastic plugs on the side from which the door was removed.

Specialty Care Guide



Always follow Fabric Manufacturer's Care Label or instructions when laundering. Otherwise use the information below as a general guide.

Item	Suggested Care
Pillows	<p>Mend any holes or weak seams where feather or filling could escape. Dry only one pillow at a time. Stop dryer occasionally and shake pillow, redistributing filling for even drying. Check pillow at the end of drying time. If it is not completely dry, reset dryer for more drying time.</p> <p>Dry on low heat only.</p> <p>CAUTION: Do not dry pillows containing foam rubber.</p>
Blankets	<p>Add 2–4 dry towels and one blanket and set timer for 20–25 minutes. Dry only one blanket at a time. Do not set control for more than 25 minutes. At the end of drying cycle block the blanket back to its original shape. Allow blanket to dry thoroughly before storing.</p>
Cotton	<p>Use a medium heat drying setting.</p>
Synthetic	<p>Use a low heat drying setting.</p>
Down	<p>Use a low heat drying setting.</p>
Extra Large Items (Includes comforters, blankets and mattress pads.)	<p>Use a low heat drying setting.</p> <p>Set dryer for 20 minutes. When time is up, check and redistribute load. Reset dryer for 15 minutes. When time is up, check and redistribute load. Reset timer for 5 minute intervals. Check after each 5 minutes to ensure articles do not fill dryer drum. Large, wet articles should have ample room in the dryer, but as they dry and fluff up they may not have room to tumble.</p> <p>CAUTION: Items without room to tumble may block air flow and could result in scorched items. Dry mattress pads separately. Use a low heat drying setting.</p>



Helpful Information

Loading

Sorting

As general rule, if clothes are sorted properly for the washer, they are sorted properly for the dryer.

Sort by color

(Separate colorfast from non-colorfast fabrics*)

- Whites
- Lights
- Darks

Separate by fabric type

- Cottons and linens
- Permanent press cottons and blends
- Synthetic and poly knits
- Delicates

Separate lint producers from lint collectors

- Lint producers: terry cloth and chenille
- Lint collectors: velveteen and corduroy

Sort by weight

- Heavy Items
- Light Items

** Non-colorfast fabrics may bleed or fade. Sort by individual color.*

Loading Hints

- Avoid drying very small loads.
- Sort clothes by weight so you won't have to run an extra cycle for one or two heavier, slower drying items.
- Do not add fabric softener sheets once the load has become warm. This may cause fabric softener stains.
- Do not overload. This causes inefficient operation and unnecessary wrinkling. Clothes need to tumble freely.
- Do not dry the following items:
 - Fiberglass items
 - Woolens
 - Rubber coated items
 - Plastics
 - Items with plastic trim
 - Foam-filled items

Care & Cleaning



Interior

The drum is rust-resistant. However, colored fabrics which lose color or bleed in the washer may cause discoloration of the dryer drum. We recommend that the dryer drum be cleaned with a cloth using a

detergent and water paste or a mild abrasive, such as Soft Scrub™. Rinse thoroughly. Then tumble-dry several wet rags or old towels for 20 to 30 minutes before using the dryer normally.

Exterior

Wipe off any spills or washing compounds. Wipe or dust with a damp cloth. Try not to strike the surface with sharp objects. Dryer control panel and finishes may be damaged by some laundry pretreatment soil and stain remover products if such products are sprayed on or have direct contact with the dryer.

Apply these pretreatment products away from the dryer. The fabric may then be washed and dried normally. Damage to your dryer caused by pretreatment products is not covered by your warranty.

Lint Filter

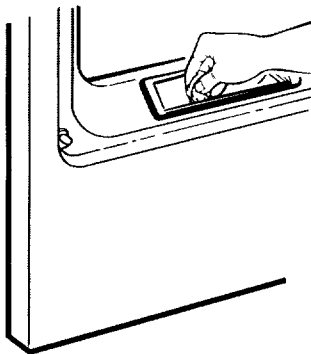

Before every dryer use, clean the lint filter. It is easier to remove the lint when your fingers are moistened.

To keep your dryer operating at peak performance, be sure to have a technician vacuum the lint from the machine every three years.

Storage

To store your dryer for a short period of time, disconnect the power supply and clean the lint filter.



Helpful Information

Care & Cleaning

Exhaust Duct

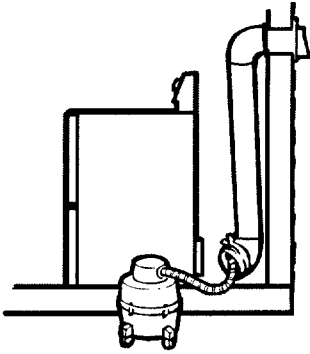

Inspect and clean the dryer exhaust ducting at least once a year to prevent clogging. A partially clogged exhaust can lengthen the drying time.

To clean the exhaust duct follow these steps:

- 1** Turn off electrical supply by disconnecting the plug from the wall socket.
- 2** Disconnect exhaust duct from the dryer.
- 3** Vacuum the exhaust duct with the hose attachment or attach a rag to a pole or drain cleaning wire and clean duct.

Exhaust Hood

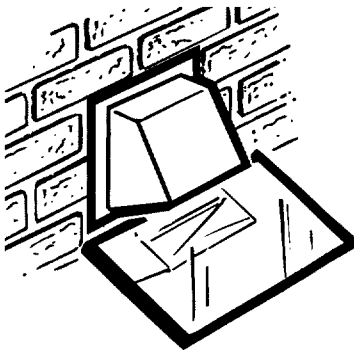

- Make sure the inside flaps of the exhaust hood move freely (you may want to check with a mirror).
- Make sure inside flaps are fully open when dryer is operating.
- Make sure there is not wild life (birds, insects, etc.) nesting inside the exhaust duct or hood.

If Something Goes Wrong

Before you call for service



Problem	Possible Causes	What to Do
Dryer doesn't start	Dryer is unplugged	<ul style="list-style-type: none">• Make sure the dryer plug is pushed completely into the outlet.
	Fuse is blown/circuit breaker is tripped	<ul style="list-style-type: none">• Check the house fuse/circuit breaker box and replace fuse or reset breaker. <p>NOTE: Most electric dryers use two breakers.</p>
Dryer doesn't heat	Fuse is blown/circuit breaker is tripped, the dryer may tumble but not heat	<ul style="list-style-type: none">• Check the house fuse/circuit breaker box and replace fuse or reset breaker.
	Gas service is off	<ul style="list-style-type: none">• Make sure gas shutoff at dryer and main shutoff are fully open.
Dryer shakes or makes excessive noise	Some shaking/noise is normal. Dryer may be sitting unevenly	<ul style="list-style-type: none">• Move dryer to an even floorspace, or adjust as necessary until even.
Greasy spots on clothes	Improper use of fabric softener	<ul style="list-style-type: none">• Follow directions on fabric softener package.
	Drying dirty items with clean ones	<ul style="list-style-type: none">• Use your dryer to dry only clean items. Dirty items can stain clean items and the dryer.
	Clothes were not completely clean	<ul style="list-style-type: none">• Sometimes stains which cannot be seen when the clothes are wet "appear" after drying. Use proper washing procedures before drying.
Lint on clothes	Lint filter is full	<ul style="list-style-type: none">• Clean lint screen before each load.
	Improper sorting	<ul style="list-style-type: none">• Sort lint producers (like chenille) from lint collectors (like corduroy).
	Static electricity can attract lint	<ul style="list-style-type: none">• See suggestions in this section under STATIC.
	Overloading	<ul style="list-style-type: none">• Separate large loads into smaller ones.
	Paper, tissue, etc. left in pockets	<ul style="list-style-type: none">• Empty all pockets before laundering clothes.



If Something Goes Wrong

Problem	Possible Causes	What to Do
Static occurs	Overdrying	<ul style="list-style-type: none">• Try a fabric softener.• Adjust controls for less drying.
	No fabric softener was used	<ul style="list-style-type: none">• Try a fabric softener.
	Synthetics, permanent press and blends can cause static	<ul style="list-style-type: none">• Try a fabric softener.
Clothes take too long to dry	Improper sorting	<ul style="list-style-type: none">• Separate heavy items from light weight items (generally, a well-sorted washer load is a well-sorted dryer load).
	Large loads of heavy items (like beach towels)	<ul style="list-style-type: none">• Large, heavy loads contain more moisture and take longer to dry. Separate large, heavy items into smaller loads to speed drying time.
	Controls improperly set	<ul style="list-style-type: none">• Match control settings to the load you are drying.
	Lint filter is full	<ul style="list-style-type: none">• Clean lint filter before every load.
	Improper or obstructed ducting	<ul style="list-style-type: none">• Check installation instructions for proper ducting/venting.• Make sure ducting is clean, free of kinks and unobstructed.• Check to see if outside wall damper operates easily.• See the Venting the Drying section.
	Blown fuses or tripped circuit breakers	<ul style="list-style-type: none">• Replace fuses or reset circuit breakers. Since most dryers use 2 fuses/breakers, make sure both are operating.
	Overloading/ combining loads	<ul style="list-style-type: none">• Do not put more than one washer load in the dryer at a time.
Underloading	<ul style="list-style-type: none">• If you are drying only one or two items, add a few items to ensure proper tumbling.	

Problem	Possible Causes	What to Do
Clothes are wrinkled	Overdrying	<ul style="list-style-type: none">• Select a shorter drying time.• Remove items while they still hold a slight amount of moisture.
	Letting items sit in dryer after cycle ends	<ul style="list-style-type: none">• Remove items when cycle ends and fold or hang immediately.
Clothes shrink	Some fabrics will naturally shrink when washed. Others can be safely washed, but will shrink in the dryer.	<ul style="list-style-type: none">• To avoid shrinkage, follow garment care labels exactly.• Some items may be pressed back into shape after drying.• If you are concerned about shrinkage in a particular item, do not machine wash or tumble dry it.



Venting the Dryer

For the best drying performance the dryer needs to be properly vented. **Carefully follow the details on Exhausting in the Installation Instructions.**

- Use only rigid metal or flexible metal 4" diameter ductwork inside the dryer cabinet or for exhausting to the outside.
- Do not use plastic or other combustible ductwork.
- Use the shortest length possible.
- Do not crush or collapse.
- Avoid resting the duct on sharp objects.
- **Venting must conform to local building codes.**

Correct Venting

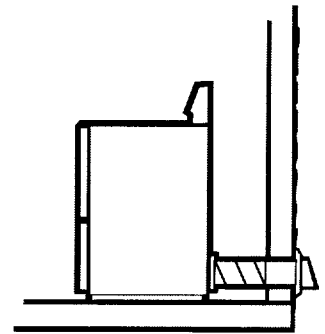
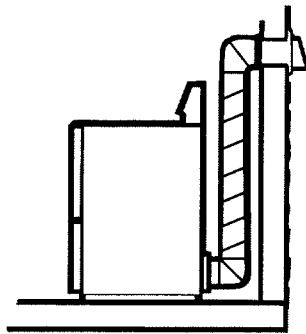

Incorrect Venting

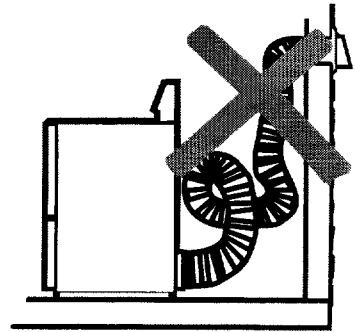
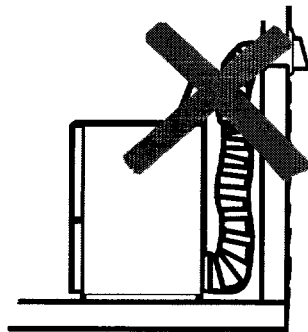

GE Service Numbers



We'll be there!

GE Answer Center®

800.626.2000

Whatever your question about any GE major appliance, GE Answer Center® information service is available to help. Your call—and your question—will be answered promptly and courteously.

And you can call any time. GE Answer Center® service is open 24 hours a day, 7 days a week.

In-Home Repair Service

**800-GE-CARES
(800-432-2737)**

A GE consumer service professional will provide expert repair service, scheduled at a time that's convenient for you. Many GE Consumer Service company-operated locations offer you service today or tomorrow, or at your convenience (7:00 a.m. to 7:00 p.m. weekdays, 9:00 a.m. to 2:00 p.m. Saturdays).

Our factory-trained technicians know your appliance inside and out—so most repairs can be handled in just one visit.

For Customers With Special Needs

800.626.2000

Upon request, GE will provide Braille controls for a variety of GE appliances, and a brochure to assist in planning a barrier-free kitchen for persons with limited mobility. To obtain these items, free of charge, call 800.626.2000.

Consumers with impaired hearing or speech who have access to a TDD or a conventional teletypewriter may call 800-TDD-GEAC (800-833-4322) to request information or service.



**Para los clientes
de habla español**

800.626.2000

Para obtener la versión en español de este manual, llame a GE Answer Center[®], servicio de información para el consumidor, teléfono 800.626.2000.

Service Contracts

800-626-2224

You can have the secure feeling that GE Consumer Service will still be there after your warranty expires. Purchase a GE contract while your warranty is still in effect and you'll receive a substantial discount. With a multiple-year contract, you're assured of future service at today's prices.

Parts and Accessories

800-626-2002

Individuals qualified to service their own appliances can have parts or accessories sent directly to their home. The GE parts system provides access to over 47,000 parts...and all GE Genuine Renewal Parts are fully warranted. VISA, MasterCard and Discover cards are accepted.

Care and cleaning instructions contained in this manual cover procedures to be performed by any user. Other servicing generally should be referred to qualified service personnel. Caution must be exercised, since improper servicing may cause unsafe operation.

Further Service

We're proud of our service and want you to be pleased. If for some reason you are not happy with the service you receive, here are three steps to follow for further help.

First, contact the people who serviced your appliance. Explain why you are not pleased. In most cases, this will solve the problem.

Next, if you are still not pleased, write all the details—including your phone number—to:

Manager, Consumer Relations
GE Appliances, Appliance Park
Louisville, KY 40225

Finally, if your problem is still not resolved, write:

Major Appliance Consumer
Action Program
20 North Wacker Drive
Chicago, IL 60606

DRYER WARRANTY

Staple sales slip or cancelled check here. Proof of original purchase date is needed to obtain service under warranty.

What is covered

FULL ONE-YEAR WARRANTY

For one year from date of original purchase, we will provide, free of charge, parts and service labor in your home to repair or replace *any part of the dryer* that fails because of a manufacturing defect.

LIMITED ADDITIONAL FOUR-YEAR WARRANTY

From the second through fifth year from date of original purchase, we will replace, free of charge, an extra large or super capacity dryer drum that fails because of a manufacturing defect. You pay for the service trip to your home and service labor charges.

This warranty is extended to the original purchaser and any succeeding owner for products purchased for ordinary home use in the 48 mainland states, Hawaii and Washington, D.C. In Alaska the warranty is the same except that it is LIMITED because you must pay to ship the product to the service shop or for the service technician's travel costs to your home.

All warranty service will be provided by our Factory Service Centers or by our authorized Customer Care[®] servicers during normal working hours.

Should your appliance need service, during warranty period or beyond, call 800-GE-CARES (800-432-2737).

What is not covered

- Service trips to your home to teach you how to use the product.

Read your Owner's Manual. If you then have any questions about operating the product, please contact your dealer or our Consumer Affairs office at the address below, or call, toll free:

GE Answer Center[®]
800.626.2000
consumer information service

- Improper installation.

If you have an installation problem, contact your dealer or installer. You are responsible for providing adequate electrical, exhausting and other connecting facilities.

- Replacement of house fuses or resetting of circuit breakers.
- Failure of the product if it is misused, or used for other than the intended purpose or used commercially.
- Damage to product caused by accident, fire, floods or acts of God.

WARRANTOR IS NOT RESPONSIBLE FOR CONSEQUENTIAL DAMAGES.

Some states do not allow the exclusion or limitation of incidental or consequential damages, so the above limitation or exclusion may not apply to you. This warranty gives you specific legal rights, and you may also have other rights which vary from state to state. To know what your legal rights are in your state, consult your local or state consumer affairs office or your state's Attorney General.

Warrantor: General Electric Company If further help is needed concerning this warranty, write:
Manager—Consumer Affairs, GE Appliances, Louisville, KY 40225

Part No. 175D1807P074
Pub. No. 49-9841

6-95 CG

Printed in the United States

DDSR475ET DWXR473ET
DDSR475GT DWXR473GT