

Thinking of you

 **Electrolux**

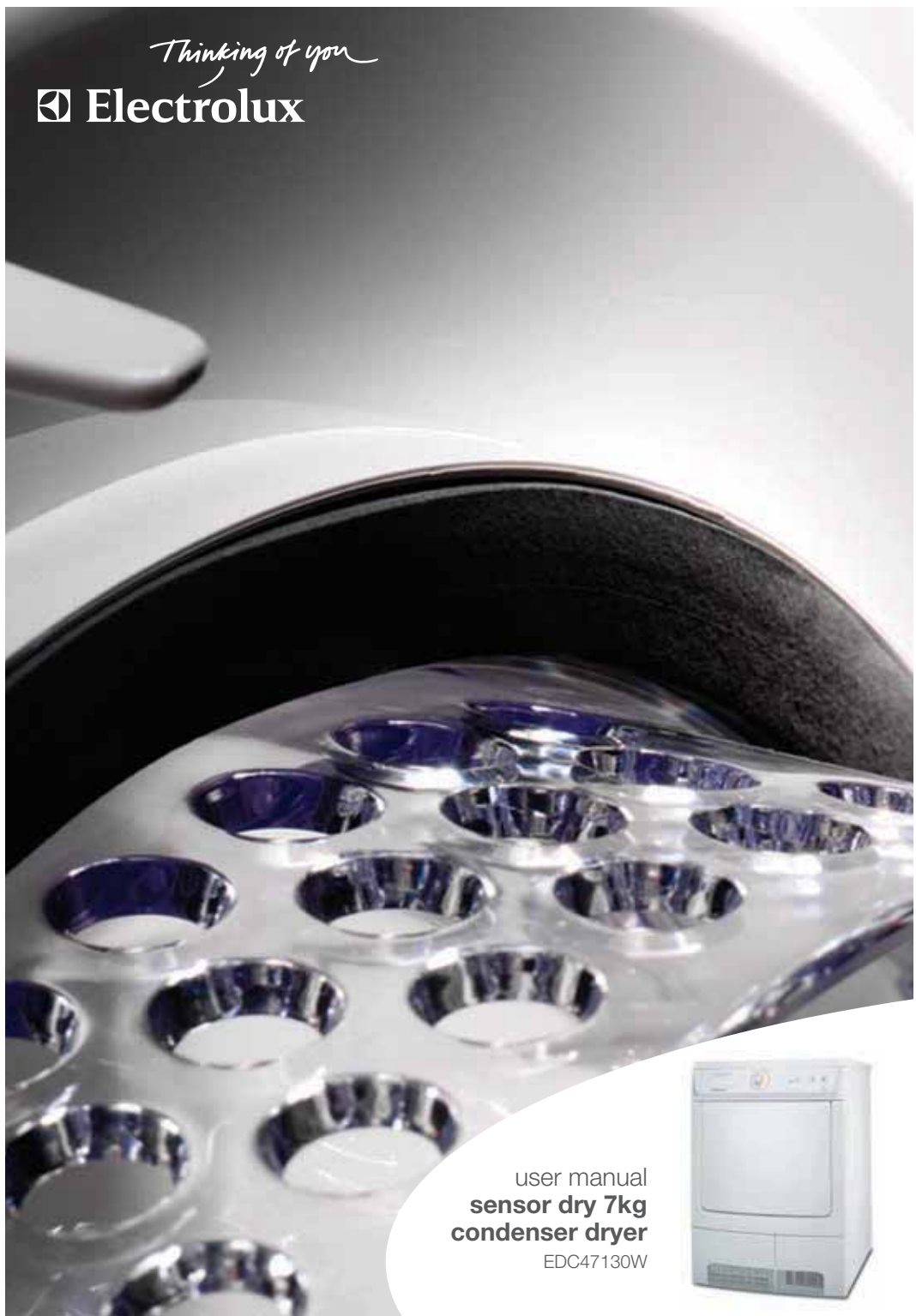

user manual
**sensor dry 7kg
condenser dryer**
EDC47130W





we were thinking of you
when we made this product



Congratulations

Congratulations and thank you for choosing our EDC47130W tumble dryer. We are sure you will find your new tumble dryer a pleasure to use. Before you use your tumble dryer, we recommend that you read through the whole user manual, which provides the description of the tumble dryer and its functions.

To avoid the risks that are always present when you use an electrical appliance it is important that the tumble dryer is installed correctly and that you read the safety instructions carefully to avoid misuse and hazards. We recommend that you keep this instruction booklet for future reference and pass it on to any future owners. After unpacking the tumble dryer please check it is not damaged. If in doubt, do not use the appliance but contact your local Electrolux Service Centre.

The symbols you will see in this booklet have these meanings:



warning

This symbol indicates information concerning your personal safety



caution

This symbol indicates information on how to avoid damaging the dryer



tips and information

This symbol indicates tips and information about use of the dryer



environmental tip

This symbol indicates tips and information about economical and ecological use of the dryer



dangerous voltage

This symbol indicates risk of injury from electrical current

Contents

Safety information	4
Product description	6
Control panel	6
Use	7-9
Drying hints	10
Drying program	11
Care and cleaning	12-14
Something not working	15-16
Technical data	16
Consumption values	16
Installation	17-18
Environment concerns	18
Warranty	19
Contact us	19

Safety Information



caution

In the interest of your safety and to ensure the correct use, before installing and first using the appliance, read this user manual carefully, including its hints and warnings. To avoid unnecessary mistakes and accidents, it is important to ensure that all people using the appliance are thoroughly familiar with its operation and safety features. Save these instructions and make sure that they remain with the appliance if it is moved or sold, so that everyone using it through its life will be properly informed on appliance use and safety.

General safety

- It is dangerous to alter the specifications or attempt to modify this product in any way.
 - This appliance is not intended for use by persons (including children) with reduced physical, sensory or mental capabilities, or lack of experience and knowledge, unless they have been given supervision or instruction concerning use of the appliance by a person responsible for their safety.
 - Make sure that small pets do not climb into the drum. To avoid this, please check into the drum before using.
 - Any objects such as coins, safety pins, nails, screws, stones or any other hard, sharp material can cause extensive damage and must not be placed into the machine.
 - In order to avoid danger of fires caused by excessive drying, do not use appliance to dry the following items: Cushions, quilts and the like (these items accumulate heat).
 - Items such as foam rubber (latex foam), shower caps, waterproof textiles, rubber backed articles and clothes or pillows fitted with foam rubber pads should not be dried in the tumble dryer.
 - Always unplug the appliance after use, cleaning and maintenance.
 - Under no circumstances should you attempt to repair the machine yourself. Repairs carried out by inexperienced persons may cause injury or serious malfunctioning. Contact your local Service Centre. Always insist on genuine spare parts.
- Oil-affected items can ignite spontaneously, especially when exposed to heat sources such as in a tumble dryer. The items become warm, causing an oxidation reaction in the oil. Oxidation creates heat. If the heat can not escape, the items can become hot enough to catch fire. Piling, stacking or storing oil-affected items can prevent heat from escaping and so create a fire hazard. If it is unavoidable that fabrics that contain vegetable or cooking oil or have been contaminated by hair care products, acetone, alcohol, petrol, kerosene, spot removers, turpentine, waxes and wax removers should be washed in hot water with an extra amount of detergent before being dried in the tumble dryer.

- **Danger of explosion:** Never tumble dry items that have been in contact with flammable solvents (petrol, methylated spirits, dry cleaning fluid and the like), as these substances are volatile and could cause an explosion. Only tumble dry items washed with water.
- **Risk of fire:** items that have been spotted or soaked with vegetable or cooking oil constitute a fire hazard and should not be placed in the tumble dryer.
- If you have washed your laundry with stain remover you must execute an extra rinse cycle before loading your tumble dryer.
- Please make sure that no gas lighters or matches have accidentally been left in pockets of garments to be loaded into the appliance.
- The final part of a tumble dryer cycle occurs without heat (cool down cycle) so that the items are left at a temperature which ensures they will not be damaged.



warning

Never stop a tumble dryer before the end of the drying cycle unless all items are quickly removed and spread out so that the heat is dissipated.

Risk of Fire!

Installation

- This appliance is heavy. Care should be taken when moving it.
- When unpacking the appliance, check that it is not damaged. If in doubt, do not use it and contact the Service Centre.
- All packing and transit bolts must be removed before use. Serious damage can occur to the product and to property if this is not adhered to. See relevant section in the user manual.
- The final part of a tumble dryer cycle occurs without heat (cool down cycle) so that the items are left at a temperature which ensures they will not be damaged.
- Any electrical work required to install this appliance should be carried out by a qualified electrician or competent person.
- Care must be taken to ensure that the appliance does not stand on the electrical supply cable.
- If the machine is situated on a carpeted floor, please adjust the feet in order to allow air to circulate freely.
- After having installed the appliance, check that it is not pressing or standing on its electrical supply cable.
- If the tumble dryer is placed on top of a washing machine, it is compulsory to use the stacking kit (optional accessory).

Use

- This appliance is designed for domestic use. It must not be used for purposes other than those for which it was designed.
- Only dry fabrics which are designed to be machine dried. Follow the instructions on each garment label.
- Do not dry unwashed items in the tumble dryer.
- Do not overload the appliance. See the relevant section in the user manual.
- Clothes which are dripping wet should not be placed in the dryer.
- Garments which have been in contact with volatile petroleum products should not be machine dried. If volatile cleaning fluids are used, care should be taken to ensure that

the fluid is removed from the garment before placing in the machine.

- Never pull the power supply cable to remove the plug from the socket; always take hold of the plug itself.
- Never use the tumble dryer if the power supply cable, the control panel, the working surface or the base are damaged so that the inside of the tumble dryer is accessible.
- Fabric softeners, or similar products should be used as specified by the fabric softener instructions.
- Always clean the lint filter before each use. Do not operate the dryer without checking the filter is clean.

Child safety

- This machine is not intended for use by young children or infirm persons without supervision.
- Children should be supervised to ensure that they do not play with the appliance.
- The packaging components (e.g. plastic film, polystyrene) can be dangerous to children – danger of suffocation! Keep them out of children's reach.
- Keep all detergents in a safe place out of children's reach.
- Make sure that children or pets do not climb into the drum.

Product Description

- 1 Control panel
- 2 Lint filters
- 3 Rating Plate
- 4 Condenser unit
- 5 Water tank
- 6 Adjustable feet

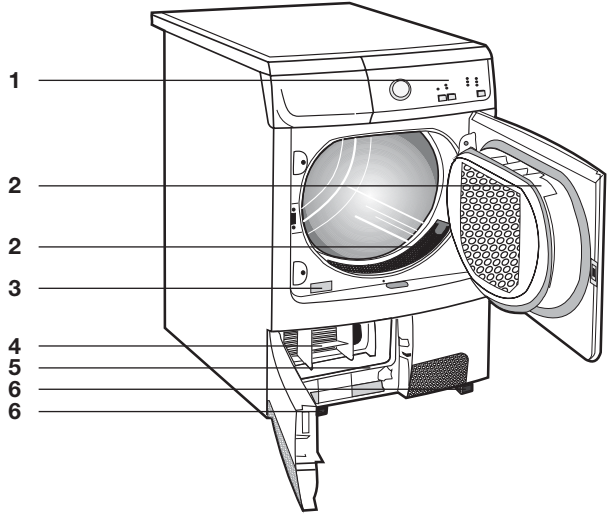

Control panel

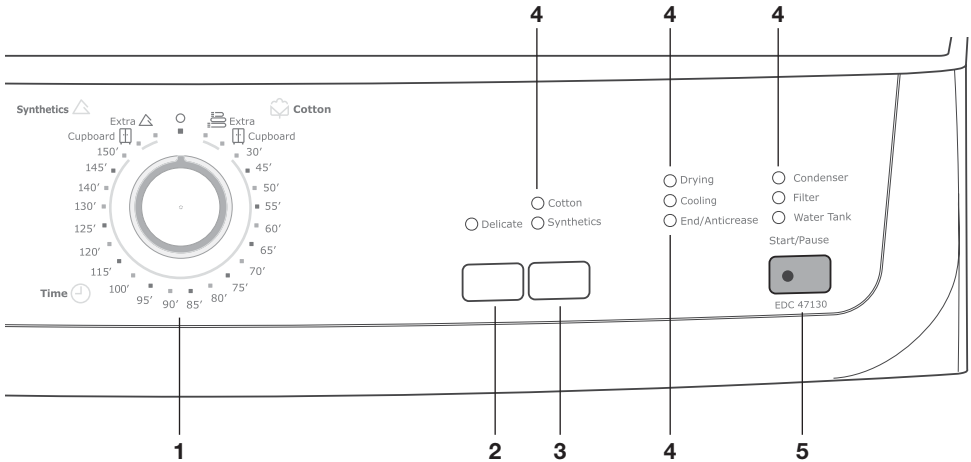

- 1 Program selector dial
- 2 Delicate button
- 3 Textile button
- 4 Indicator lights
- 5 Start/Pause button

Use

First Use

tips and information

- Ensure that the electrical connections comply with the installation instructions.
- Remove the polystyrene block and any material from the drum.
- Before using your tumble dryer for the first time, we recommend that you place a few damp cloths inside the appliance and dry for 30 minutes.
There may be dust inside a brand new tumble dryer.

Daily Use

Load the laundry

tips and information

Connect the appliance.
Open the door (see picture).



Place the laundry in the drum, one item at a time, shaking them out as much as possible.
Close the door.

Please check the laundry does not get caught between the door and filter.

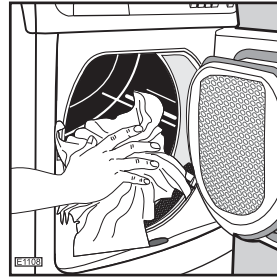

Select the required program

Turn the program selector dial to the required program.

The Start/Pause light starts to flash.

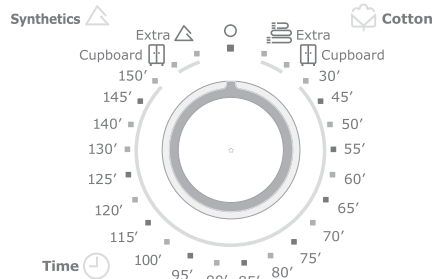

The selector dial is divided into the following sections:

-  Cotton
-  Synthetics
-  Time

Allows you to select electronically controlled or time controlled drying.

Turn the dial to the required program or time and press the stop/start button to commence the cycle.

Electronically controlled drying (automatic)

The appliance runs these programs with the help of probes which detect the degree of dampness of the laundry. Simply select the program according to the type of laundry and degree of drying required.

The selector dial can be turned either clockwise or anti clockwise. The lights use Drying, Cooling and End/Antcrease illuminates.

Use

At the end of the program the selector dial must be turned to position O, to switch the machine off.

Attention!

If you turn the program selector dial to another program when the machine is working, the lights or the program progress display start to flash. The machine will not perform the new selected program.

Program Option buttons

Depending on the program, different functions can be combined. These must be selected after choosing the desired program and before depressing the Start/Pause button.

When these buttons are pressed, the corresponding pilot lights come on. When they are pressed again, the pilot lights go out.

Select Delicate

Pressing this button allows drying to be performed at a lower temperature, for delicate items.

Delicate



The corresponding pilot light comes on. This option can also be used for time controlled drying. DELICATE is only suitable for use with loads of up to 3kg!

When the program has finished the pilot light **End/Anticrease** is on.

Select the Textile

Press the Textile button repeatedly, to select the desired option. The relevant light will light up.

- Cotton
- Synthetics



You can select 2 different options:

Cotton Cycle: to be used for cotton.

When the program has finished the pilot light **End/Anticrease** is on.

Synthetics: to be used for synthetic or delicate items. When the program has finished the pilot light **End/Anticrease** is on.

Select the Start/Pause

Press this button to start the dryer after having selected the program and the options.

The relevant light will stop flashing. If the program selector dial is turned to another position when the machine is running, the buzzer will sound and the program phase indicator lights will flash.

The drum turns alternately in both directions during drying.

All drying programs end with a 10 minute cooling phase (Cooling light is on).

You may remove the laundry after this phase.

The lights Filter and Water Tank illuminate and the buzzer sounds.

If the door of the appliance or the small door at the bottom is opened while the program is running, this button must be pressed again after closing the door in order to restart the program from the point at which it was interrupted. This button must be depressed also after a power failure and after having reinserted the water tank, if it has been emptied in the middle of a program.

In both cases the Start/Pause button flashes to remind you that the start button needs to be pressed again.

Indicator lights

These lights indicate the following functions:

○ Drying light

This light indicates that the appliance is in the drying phase.

○ Cooling light

This light indicates that the appliance is in the cooling phase. At the end of drying, there is a 10 minute cooling phase to cool the laundry.

○ End/Anticrease light

This light is on at the end of the cooling phase, during the anti-creasing phase and at the end of the program.

○ Condenser light

It comes on every 80 cycles to remind you that the condenser must be cleaned.

○ Filter light

This light illuminates at the end of the program to remind you that the filters must be cleaned.

○ Water Tank light

This light comes on at the end of the program to remind you that the water tank must be emptied out. If this light illuminates during a program this means that the water tank is full. The buzzer sounds, the program stops, the Start/Pause button flashes. This light comes on also when the water tank is not inserted correctly.

At the end of the program

All drying programs end with a 10 minute cooling phase.

You may remove the laundry after this phase. The lights ○ Filter and ○ Water Tank illuminate. The display shows a static zero.

If the laundry is not removed at the end of the cycle, the dryer performs an **antirecreasing** phase (duration: 30 minutes maximum). If you do not remove the laundry, the dryer will stop automatically at the end of the anti-creasing phase. Lights ○ Filter and ○ Water Tank remain lit and the buzzer sounds for 2 minutes.

Turn the program selector dial to “O” to switch the machine off. Remove the laundry from the drum and carefully check that the drum is empty.

If you open and then close the door before turning the selector dial to “O” all the lights corresponding to the phases making up the performed program come on.

After each use

- Clean the filters.
- Empty the water tank.

Modifying the program

To change a program which is running, first cancel it by turning the program selector dial to “O”. Select the new program and press the Start button .

Drying hints



tips and information

Before loading the laundry

Never tumble dry the following: Particularly delicate items such as net curtains, woollens, silk, fabrics with metal trim, nylon tights, bulky materials such as anoraks, blankets, eiderdowns, sleeping bags, feather quilts and any items containing rubber foam or materials similar to rubber foam.

- Always follow the instructions on garment labels:



may be tumble dried



normal drying (high temperature)



delicate drying (low temperature)



do not tumble dry

- Close pillowcases and covers with fasteners to prevent small laundry items getting tangled inside them. Close press studs, zips and hooks and tie belts and apron strings.
- Sort laundry according to type and degree of drying required.
- Do not over-dry laundry, this avoids creasing and saves energy.
- Avoid drying dark clothes with light coloured fluffy items such as towels as they could attract fluff.
- The laundry must be thoroughly spun before tumble drying.
- **Easy-care items**, e.g. shirts, should be briefly pre-spun before drying (depending on crease resistance approx. 30 seconds or using the special brief spin program of your washing machine).
- Knitted textiles (knitted underwear) may shrink a little during drying. Please do not overdry items of this type. It is advisable to allow for shrinkage when choosing the size of new purchases.
- Remove the laundry when the dryer has finished drying.
- If individual items are still damp after drying, set a brief post-drying time, **(at least 30 minutes)**. This will be necessary particularly for multilayered items (e.g. collars, pockets, etc.).

Make sure that no metal objects are left in the laundry (e.g. hair clips, safety pins, pins).

Button up pillowcases, close zip fasteners, and hooks. Tie any belts or long tapes.

To avoid laundry becoming tangled: close zips, button up duvet covers and tie loose ties or ribbons (e.g. of aprons).

Turn items with double-layered fabrics inside out (e.g. with cotton lined anoraks, the cotton layer should be outermost). These fabrics will then dry better.

Maximum loads

Recommended loads are indicated in the program charts.

General rules:











Cotton, linen: drum full but not too tightly packed;

Synthetics: drum no more than half full;

Delicate fabrics and woollens: drum no more than one third full.

Try to load to the maximum capacity of the machine as small loads are uneconomical.

Drying programs

Program	Type of laundry	Description of program
 Extra	 Cotton	Drying thick or multi-layered textiles, e.g. terry towelling items.
 Cupboard	 Cotton	Thorough drying of fabrics of even thickness, e.g. terry towelling items, knitted items, towels.
 Extra	 Synthetics	Thorough drying of thick or multilayered fabrics, e.g. pullovers, bedding, table linen.
 Cupboard	 Synthetics	For thin fabrics which are not ironed, e.g. easy care shirts, table linen, baby clothes, socks, lingerie with bones or wires.
 Time	 Synthetics	If the TIME program has been selected, program duration time of 30 minutes and up to 150 minutes can be set by intervals of 5 minutes or 10 minutes. Drying thick or multi-layered textiles, e.g. terry towelling items.

Cotton Extra program is the energy rating label program in accordance with AS/NZS2442.2:2000



tips and information

Max Cottons load: 7kg

Max Synthetics load: 3kg

Max Time load: 7kg

Laundry weights

The following weights are indicative:

bathrobe	1200g
napkin	100g
quilt cover	700g
sheet	500g
pillow case	200g
tablecloth	250g
towelling towel	200g
tea cloth	100g
night dress	200g
ladies' briefs	100g
men's work shirt	600g
men's shirt	200g
men's pyjamas	500g
blouse	100g
men's underpants	100g

Care and cleaning

tips and information

You must **DISCONNECT** the appliance from the electricity supply, before you can carry out any cleaning or maintenance work.

External cleaning

Use only soap and water and then dry thoroughly.

Important: do not use methylated spirit, dilutents or similar products.

Cleaning the door

Periodically clean the interior part of the door to remove any fluff from the seals around the filter. Accurate cleaning ensures correct drying.

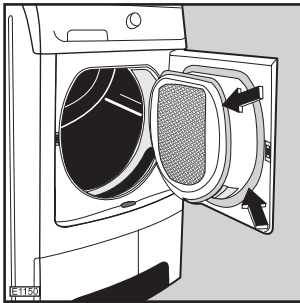

Cleaning the filters

Your dryer will only function well if the filters are clean. The filters collect all the fluff which accumulates during drying and they must therefore be cleaned **at the end of each program**, before removing the laundry, with a damp cloth. The light  is on to remind you of this operation.



The filter in the inner door must be removed for cleaning.

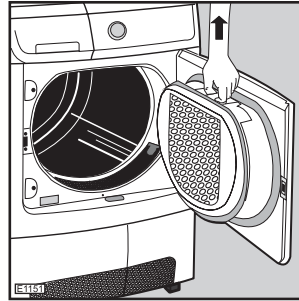

Do not be alarmed by the amount of fluff. It is not due to excessive wear caused by the dryer. All fabric loses fluff when drying but it goes unnoticed in the air. In a tumble dryer it simply collects in the filter.

After a while, a whitish film due to detergent residue on laundry forms on the filters. When this occurs, clean the filters with warm water using a brush. Remove the filter in the door opening as per picture below (it can be positioned with the tooth facing to the left or to the right).



i tips and information

Do not use the appliance without filters.

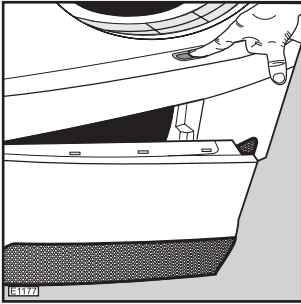

Cleaning the condenser unit

Clean the condenser when the light
 O Condenser comes on.

The condenser is situated at the lower part of the cabinet behind a small door. To open the door, push the catch as per picture above. During the drying cycle or at the end, it is normal for water to be present on the surface of the condenser unit.

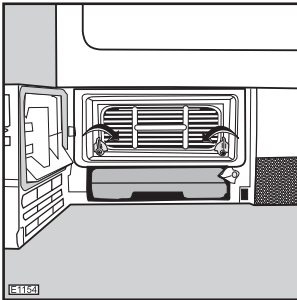

To pull out the condenser, first turn the two red stops downwards and then remove the condenser unit holding it at the handle.

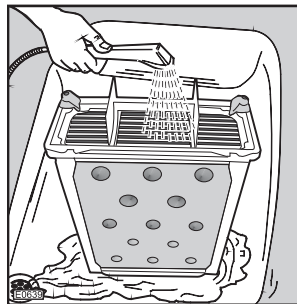
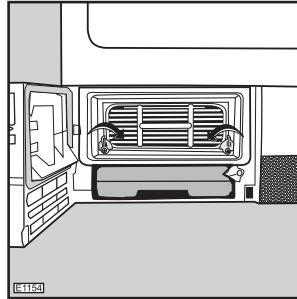

Clean it with a brush and rinse it under the shower if necessary.

Also clean the outside, removing all fluff.

Clean the rubber seal round the condenser cabinet and in the inner part of the small door with a damp cloth.

i tips and information

Important! Do not use pointed objects or utensils to clean the spaces between the plates, as this could damage the condenser and make it permeable.

Re-fit the condenser, turn the red stops upwards and close the door.

i tips and information

Do not use this appliance if the condenser has not been fitted.

Care and cleaning

Emptying the water tank

Water extracted from the laundry condenses inside the machine and is collected in a tank.

The tank must be emptied **after each drying cycle** to ensure efficient operation when the machine is next used. The light **Water Tank** reminds you of this operation.

Proceed as follows:

- Open the small door at the lower part of the cabinet
- Turn the yellow stops upwards
- Pull out the tank
- Open the small cover and empty the water out of the container
- Close the small cover and correctly re-insert the tank
- Push the container in until it clicks, then turn the yellow stops downwards to lock it firmly into place
- Close the small door and press the **START/PAUSE** button again to allow the program to continue.

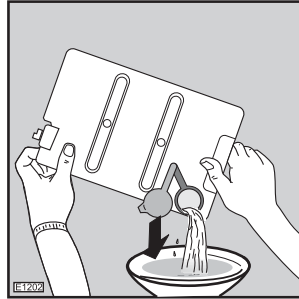
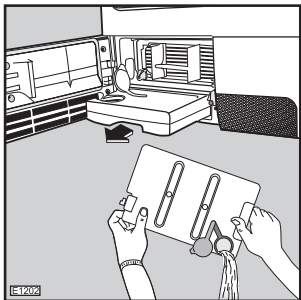
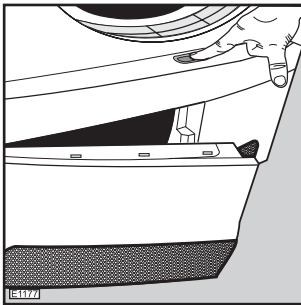

The tank must be re-inserted correctly.

After emptying and inserting the tank the **Start/Pause** button has to be depressed again to allow the program to continue.

Handy tip: The condensed water may be used in a steam iron or to top up a battery, etc. In this case it must be filtered (e.g. through a coffee filter).

Cleaning the air intake grille

Using a vacuum cleaner remove the fluff from the air intake grille at the back of the appliance.

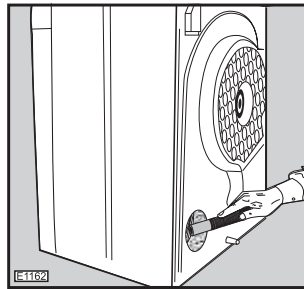

Cleaning the drum

When your laundry does not reach the desired degree of dryness, in other words, when it turns out either too dry or too damp, we advise you to clean the inside of the drum with a cloth soaked with vinegar.

This will eliminate the slight film that has formed in the drum (due to residues of detergent and softeners used in the washing, and from the lime contained in the water), which prevents the probes from detecting the correct degree of dryness.

Something not working

Certain problems are due to lack of simple maintenance or oversights, which can be solved easily without calling out an engineer. Before contacting your local Service Centre, please carry out the checks listed below. During machine operation it is possible that

the **red Start/Pause** pilot light flashes to indicate that the machine is not working.

Once the problem has been eliminated, press the **Start/Pause** button to restart the program. If after all checks, the problem persists, contact your local Service Centre.

Malfunction	Possible cause	Solution
Dryer does not work	<ul style="list-style-type: none"> • Mains plug is not plugged in or fuse is not working correctly • Loading door is open • Have you pressed the START/ PAUSE button? 	<ul style="list-style-type: none"> • Plug in at mains socket • Check fuse in fuse box (domestic installation) • Close loading door • Press the START/PAUSE button again
Drying results unsatisfactory	<ul style="list-style-type: none"> • Wrong program selected • Lint filter clogged • Condenser unit clogged with lint • Incorrect load size • Ventilation slots in base area covered up • Residue on inside surface of drum or drum ribs 	<ul style="list-style-type: none"> • Select a different program the next time you use the dryer (see "Overview of programs" section). • Clean lint filter • Clean condenser unit. • Observe recommended loading volumes. • Uncover ventilation slots in base area. • Clean inside surface of drum and drum ribs
Loading door does not close	<ul style="list-style-type: none"> • Fine strainer not in place and/or large mesh filter not locked in place. 	<ul style="list-style-type: none"> • Install fine strainer and/or snap large mesh filter into place
When pressing a button, the corresponding button flashes several times.	<ul style="list-style-type: none"> • Washing protection After the start of the program, the option can no longer be set 	<ul style="list-style-type: none"> • Turn the program knob to OFF. Set the program again
Drying cycle ends shortly after program starts. END light illuminated	<ul style="list-style-type: none"> • Not enough washing loaded or washing loaded is too dry for selected program. 	<ul style="list-style-type: none"> • Select time program or higher drying level (e.g. EXTRA DRY instead of CUPBOARD).
Program inactive, Water tank full light illuminated	<ul style="list-style-type: none"> • Water Tank is full 	<ul style="list-style-type: none"> • Empty water tank, then start program with START/PAUSE button.
Drying cycle lasts an unusually long time. Note: After around 5 hours the drying cycle ends automatically (see "Drying cycle complete")	<ul style="list-style-type: none"> • Lint filter clogged • Condenser unit clogged with lint • DELICATE button pressed and load volume too big • Load size too big • Laundry insufficiently pre-drained 	<ul style="list-style-type: none"> • Clean lint filter • Clean condenser unit • DELICATE is only suitable for use with loads of up to 3 kg! • Reduce load size • Laundry must be sufficiently spun and/or adequately pre-drained

If you are unable to identify or solve the problem, contact our service centre. Before phoning, make a note of the model, serial number and purchase date of your machine: the Service Centre will require this information.

Important: if you call out an engineer to a fault listed on page 15, or to repair a fault caused by incorrect use or installation, a charge will be made even if the appliance is under warranty.

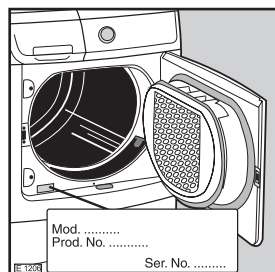

Technical data

Dimensions	Width 60cm Height 85cm Depth 58cm
Electrical connection Voltage – Overall power – Fuse	Information on the electrical connection is given on the rating plate on the inner edge of the appliance door
Depth with loading door open	109cm
Maximum Load	Cotton 7kg Synthetics 3kg
Use	Domestic + 5°C + 35°C

Installation

Unpacking

tips and information

Slide out the polyethylene bag with the polystyrene stuffing before using the appliance. Pull off the adhesive strips from the top of drum inside the machine.

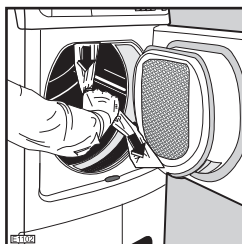

Please Note: If this appliance is supplied from a cord extension set or electrical portable outlet device it must be positioned so that it is not subject to splashing or ingress of moisture.

tips and information

The tumble dryer must not be installed behind a lockable door, a sliding door or a door with a hinge on the opposite side to that of the tumble dryer in such a way that a full opening of a tumble dryer door is restricted.

Positioning

It is recommended that, for your convenience, the machine is positioned close to your washing machine.

The tumble dryer must be installed in a clean place, where dirt does not build up.

Air must be able to circulate freely all around the appliance. Do not obstruct the front ventilation grille or the air intake grilles at the back of the machine.

To keep vibration and noise to a minimum when the dryer is in use, it should be placed on a firm, level surface.

Once in its permanent operating position, check that the dryer is absolutely level with the aid of a spirit level. If it is not, raise or lower the feet until it is.

The feet must never be removed. Do not restrict the floor clearance through deep pile carpets, strips of wood or similar. This might cause heat build-up which would interfere with the operation of the appliance.

i tips and information

Important

The hot air emitted by the tumble dryer can reach temperatures of up to 60°C. The appliance must therefore not be installed on floors which are not resistant to high temperatures.

When operating the tumble dryer, the room temperature must not be lower than +5°C and higher than +35°C, as it may affect the performance of the appliance.

Stacking kit

A special stacking kit is available through your dealer, to enable the mounting of the dryer on top of a front loading washing machine which covers a depth between 48 and 60cm.

Read carefully the instructions supplied with the kit.

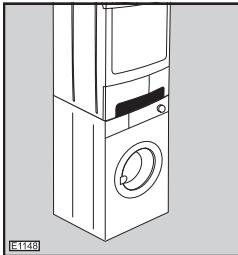

Electrical connection

This machine is designed to operate on a 230-240V, single-phase, 50Hz supply. Check that your domestic electrical installation can take the maximum load required, also taking into account any other appliances in use.

Connect the machine to an earthed socket, in accordance with current wiring regulations.

i tips and information

The manufacturer declines any responsibility for damage or injury through failure to comply with the above safety precaution. Should the appliance power supply cable need to be replaced, this must be carried out by our Service Centre.

i tips and information

Important!

The power supply cable must be accessible after installing the machine.

Environment concerns

Packaging materials



environmental tip

The materials marked with the symbol  are recyclable.

>PE<=polyethylene

>PS<=polystyrene

>PP<=polypropylene

This means that they can be recycled by disposing of them properly in appropriate collection containers.

Old machine

Use authorised disposal sites for your old appliance. Help to keep your country tidy!

The symbol  on the product or on its packaging indicates that this product may not be treated as household waste. Instead it shall be handed over to the applicable collection point for the recycling of electrical and electronic equipment. By ensuring this product is disposed of correctly, you will help prevent potential negative consequences for the environment and human health, which could otherwise be caused by inappropriate waste handling of this product. For more detailed information about recycling of this product, please contact your local city office, your household waste disposal service or the shop where you purchased the product.

Ecological hints



environmental tip

To save energy and to help protect the environment, we recommend that you follow these hints:

- Try to load the maximum capacity of the machine as small loads are uneconomical.
- Always load well spun laundry. The higher the spin speed, the lower the electricity consumption and the shorter the drying times.
- Do not over-dry laundry, this avoids creasing and saves energy. Select the drying program according to the type of laundry and the required degree of dryness.
- To utilize the maximum load, laundry which is to be dried ready to put away (store-dry) can be dried together with items to be ironed. To do this, select the program for iron-dry, remove the iron-dry items at the end of the program and then finish-dry the rest of the load.
- Clean the filters regularly to avoid excessive drying times and high electricity consumption.
- Ventilate the room well. The room temperature should not exceed +35°C during drying.
- Regularly clean the air intake.

Electrolux Warranty

FOR SALES IN AUSTRALIA AND NEW ZEALAND
APPLIANCE: ELECTROLUX EDC47130W TUMBLE DRYER

This document sets out the terms and conditions of product warranties for the Electrolux EDC47130W Tumble Dryer. It is an important document. Please keep it with your proof of purchase documents in a safe place for future reference should you require service for your Electrolux appliance.

General Terms and Conditions

1. In this warranty

- (a) 'Appliance' means Electrolux Home Products Pty Ltd ABN 51 004 762 341 in respect of Appliances purchased in Australia and Electrolux (NZ) Limited in respect of Appliances purchased in New Zealand;
- (b) 'Appliance' means any Electrolux product purchased by you accompanied by this document;
- (c) 'Warranty Period' means
- where you use the Appliance for personal, domestic or household purposes in Australia the period of "24" months and in New Zealand the period of "24" months;
 - where you use the Appliance for commercial purposes, in Australia the period of "3" months and in New Zealand the period of "3" months, (if the period stated is 0 months you are not covered by this product warranty)

following the date of original purchase of the Appliance;

- (d) 'you' means the purchaser of the Appliance not having purchased the appliance for re-sale, and 'your' has a corresponding meaning.

2. This warranty only applies to Appliances purchased and used in Australia or New Zealand and is in addition to (and does not exclude, restrict, or modify in any way) any non-excludable statutory warranties in Australia or New Zealand.
3. Electrolux warrants that, when dispatched from an Electrolux warehouse, the Appliance is free from defects in materials and workmanship for the Warranty Period.
4. During the Warranty Period Electrolux or its Authorised Service Centre will, at no extra charge if your appliance is readily accessible without special equipment, and subject to these terms and conditions, repair or replace any parts which it considers to be defective. You agree that any replaced Appliances or parts become the property of Electrolux. This warranty does not apply to light globes, batteries, filters or similar perishable parts.
5. Parts and Appliances not supplied by Electrolux are not covered by this warranty.
6. Where you are within an Electrolux service area, this warranty covers the cost of transport of the Appliance to and from Authorised Service Centres of Electrolux and travelling costs for representatives of the Authorised Service Centre to and from your home or business. If you are outside an Electrolux service area, you will bear these costs. For information about whether you are within an Electrolux service area, please phone 13 13 49 in Australia, or 0800 10 66 10 in New Zealand.
7. Proof of purchase is required before you can make a claim under this warranty.
8. You may not make a claim under this warranty unless the defect claimed is due to faulty or defective parts or workmanship. Electrolux is not liable in the following situations (which are not exhaustive):

- (a) The Appliance is damaged by:
- accident
 - misuse or abuse, including failure to properly maintain or service
 - normal wear and tear
 - power surges, electrical storm damage or incorrect power supply
 - incomplete or improper installation
 - incorrect, improper or inappropriate operation
 - insect or vermin infestation.
- (b) The Appliance is modified without authority from Electrolux in writing.
- (c) The Appliance's serial number or warranty seal has been removed or defaced.
- (d) The Appliance was serviced or repaired by anyone other than Electrolux or its Authorised Service Centres.
9. This warranty, the contract to which it relates and the relationship between you and Electrolux are governed by the law applicable in the Australian State where the Appliance was purchased or the law applicable in New Zealand if the Appliance was purchased in New Zealand. Where the Appliance was purchased in New Zealand for business purposes the Consumer Guarantee Act does not apply.

Limitation of Liability

10. To the extent permitted by law:
- Electrolux excludes all warranties other than as contained in this document;
 - Electrolux shall not be liable for any loss or damage whether direct or indirect or consequential arising from your purchase, use or non-use of the Appliance.
11. Provisions of the Trade Practices Act and State consumer legislation in Australia, and the Consumer Guarantees Act, the Sale of Goods Act and the Fair Trading Act in New Zealand, imply warranties or conditions, or impose obligations, upon Electrolux which cannot be excluded, restricted or modified. To the extent permitted by law, the liability of Electrolux (if any) arising out of or in relation to the Appliance or any services supplied by Electrolux shall be limited (where it is fair and reasonable to do so):
- in the case of Appliances, at its option, to the replacement or repair of the Appliances or the supply of equivalent products or the payment of the cost of replacing the Appliances or having the Appliances repaired or of acquiring equivalent Appliances. Upon being replaced, parts and Appliances become the property of Electrolux; or
 - in the case of services, at its option, to the supply of the services again or the payment of the cost of having the services re-supplied;
- and in the case of Appliances or services supplied in New Zealand, loss or damage whether direct or indirect or consequential that is reasonably foreseeable.

Privacy

You acknowledge that in the event that you make a warranty claim it will be necessary for Electrolux and its Authorised Service Centres to exchange information in relation to you to enable Electrolux to meet its obligations under this warranty.

Important Notice

Before Calling a Service Technician please check carefully the operating instructions, service booklet and the warranty terms and conditions.

<p>FOR SERVICE or to find the address of your nearest state service centre in Australia PLEASE CALL 13 13 49 <small>For the cost of a local call (Australia only)</small></p>	<p>SERVICE AUSTRALIA  ELECTROLUX HOME PRODUCTS www.electrolux.com.au</p>	<p>FOR SPARE PARTS or to find the address of your nearest state spare parts centre in Australia PLEASE CALL 13 13 50 <small>For the cost of a local call (Australia only)</small></p>
<p>FOR SERVICE or to find the address of your nearest authorised service centre in New Zealand FREE CALL 0800 10 66 10 <small>(New Zealand only)</small></p>	<p>SERVICE NEW ZEALAND  ELECTROLUX HOME PRODUCTS www.electrolux.co.nz</p>	<p>FOR SPARE PARTS or to find the address of your nearest state spare parts centre in New Zealand FREE CALL 0800 10 66 20 <small>(New Zealand only)</small></p>

Electrolux Home Products Australia

telephone: 1300 363 640
fax: 1800 350 067
email: customercare@electrolux.com.au
web: www.electrolux.com.au

Electrolux Home Products New Zealand

phone: 09 573 2384
fax: 09 573 2221
email: customercare@electrolux.co.nz
web: www.electrolux.co.nz

The Thoughtful Design Innovator.

Do you remember the last time you opened a gift that made you say "Oh! How did you know? That's exactly what I wanted!" That's the kind of feeling that the designers at Electrolux seek to evoke in everyone who chooses or uses one of our products. We devote time, knowledge, and a great deal of thought to anticipating and creating the kind of appliances that our customers really need and want.

This kind of thoughtful care means innovating with insight. Not design for design's sake, but design for the user's sake. For us, thoughtful design means making appliances easier to use and tasks more enjoyable to perform, freeing our customers to experience the ultimate 21st century luxury: ease of mind. Our aim is to make this ease of mind more available to more people in more parts of their everyday lives, all over the world.

The "Thinking of you" promise from Electrolux goes beyond meeting the needs of today's consumers. It also means we're committed to making appliances safe for the environment—now and for future generations.

Electrolux. Thinking of you.

Share more of our thinking at www.electrolux.com.au or www.electrolux.co.nz