

I N F O



INSTALLATION AND INSTRUCTION MANUAL  
TUMBLE DRYER EDE 405 M

 **Electrolux**

---

# CONTENTS

---

<b>Warnings</b> . . . . .	Page	3
<b>Intallation</b> . . . . .	Page	4
Positioning . . . . .	Page	4
Levelling . . . . .	Page	5
Door reversal . . . . .	Page	5
Electrical connections . . . . .	Page	6
<b>Use</b> . . . . .	Page	7
Control panel . . . . .	Page	7
Use of controls . . . . .	Page	7
Drying Times . . . . .	Page	8
Drying . . . . .	Page	9
Useful hints . . . . .	Page	9
<b>Maintenance</b> . . . . .	Page	10
External cleaning . . . . .	Page	10
Cleaning the door . . . . .	Page	10
Cleaning the filter . . . . .	Page	10
<b>Servicing</b> . . . . .	Page	10
<b>Electrolux Guarantee Conditions</b> . . . . .	Page	11
<b>Electrolux After Sales Service</b> . . . . .	Page	12

---

## TECHNICAL SPECIFICATIONS

---

DIMENSIONS	Height	85 cm (33.5")
	Width	60 cm (23.6")
	Depth	57 cm (22.4")
ELECTRICAL CONNECTION	Voltage	220-240 V/50 Hz
	Max. power absorbed	2650 W (13A)
DRYING CAPACITY	Cotton, linen	5 kg (11 lb)
	Synthetics	2 kg (4.5 lb)

---

### Stacking kit

A special stacking kit is available through your dealer, to enable the mounting of the dryer on top of your washing machine.

---

# WARNINGS

---

**It is most important that this instruction book should be retained with the appliance for future reference. Should the appliance be sold or transferred to another owner, or should you move house and leave the appliance, always ensure that the book is supplied with the appliance in order that the new owner can get to know the functioning of the appliance and the relevant warnings.**

**These warnings have been provided in the interest of safety. You MUST read them carefully before installing or using the appliance.**

## INSTALLATION

- Any electrical work required to install this appliance should be carried out by a qualified electrician or competent person.
- Make sure that the appliance does not stand on its electrical supply cable.
- **If the machine is situated on a carpeted floor, please adjust the feet in order to allow air to circulate freely.**
- This tumble dryer is designed to be vented through to the open air. It should have its own ventilation system which should not be joined with any other ventilation system connected to any other appliance.

## USE

- Always unplug the appliance after use.
- Clothes which are dripping wet should not be placed in the dryer.  
Always load well spun laundry. The higher the spin speed, the lower the electricity consumption and the shorter the drying times.
- Never tumble dry items that have been in contact with chemicals such as dry cleaning fluid. These are of a volatile nature and could cause an explosion.
- As some bulky items such as duvets and eider-downs should be dried in large commercial machines because of their bulk, check with the manufacturer of the item if it is suitable for drying in a domestic machine, even if the dry weight of the item is within the limit advised.
- Always check that no cigarette lighters have been left in pockets.
- Leave the porthole door slightly ajar when not in use to preserve the door seal.
- The fluff filter must be cleaned after every use.
- Do not operate the appliance with a damaged filter or with no filter at all, as this may cause a fire.
- Do not overload the appliance.
- Do not allow fluff to accumulate around the dryer.

## SERVICE/REPAIR

- Under no circumstances should you attempt to repair the machine yourself. Repairs carried out by inexperienced persons may cause injury or serious malfunctioning. Refer to your local Electrolux Service Centre. Always insist on genuine Electrolux spare parts.

## GENERAL SAFETY

- It is dangerous to modify or try to modify the specifications of this appliance in any way.
- This appliance is designed to be used by adults. Children should not be allowed to touch the controls or play with the product.
- Pets and small children may climb into tumble dryers. Check your appliance each time before use.

## ENVIRONMENT PROTECTION

- The materials used on this appliance marked with the symbol  are recyclable. This means that they can be recycled by disposing of them properly in appropriate collection containers.
- If you take your appliance to a refuse disposal site, cut off the power cable flush with the appliance to avoid the danger of the appliance being re-used, and disable the door catch to prevent children becoming trapped inside.

# INSTALLATION

## Positioning

The appliance may be placed in any room, provided the following precautions are taken.

The appliance expels hot, very moist air. The rest of the house must be able to easily absorb this moisture. Normally, absorption is only possible in houses where there is very little humidity. Otherwise, the room must have ventilation towards the outside; generally, an open door or window is enough.

The capacity of the venting circuit must be at least 150 m<sup>3</sup>/hour. Check that the air inlet and outlet vents are unobstructed.

The best way of evacuating the moisture is through a vent hose to the outside of the building. Use the special 100 mm diameter flexible hose supplied with the appliance connected to one of the air outlet vents with the collar supplied.

The unused outlets must be covered.

Never connect the air vent hose into an existing discharge pipe or duct, as this could be dangerous, might disturb neighbours and could cause the dryer to malfunction.

**This product is supplied with a 2.50 metre vent hose, although the maximum length of the vent hose may be:**

4 metres with no bends, or  
2 metres with 2 bends.

**Advice:** If the hose is long and the room temperature low, the moisture might condense to water inside the hose. **This is an unavoidable natural phenomenon.** To prevent this water from lying in the hose or flowing back into the tumble dryer, it is advisable to drill a small hole (dia. 3 mm) in the lowest point of the hose and to place a small container below it. (See picture, point A).

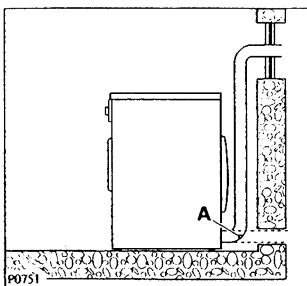

Connect the other end of the hose to an opening in a door or window. Fit a suitable shield or point the hose downwards to prevent any rain water and wind from getting in.

Rain and wind shields for placing over openings usually consist of valves or movable flaps. Periodically check the shield since strong winds and other factors (rust, dirt) can sometimes prevent it from opening, so causing problems with air venting.

If you use a rain shield, check that the openings in it are large enough to allow air to escape. Openings which are too small restrict the flow of air.

Problems can be encountered in rooms fitted with a very powerful central extractor fan. If you find that drying times are too long, switch off the extractor or close its grille whilst the tumble dryer is in use.

A highly effective solution is to simply poke the vent hose through a window or skylight. This might however cause problems in winter because the dryer will draw in very cold (and often also very damp) air through the open window, so increasing drying times and leading to very high energy consumption.

**If the dryer is fitted next to kitchen units, make sure that the vent hose is not squashed. If the hose is partially squashed, drying efficiency will be reduced, resulting in longer drying times and higher energy consumption.**

**If the hose is completely squashed, the safety cut-outs with which the machine is fitted may operate.**

## Condensation discharge through the vent hose

Condensation may be discharged either through a vent outlet provided at the back or through the left or right side outlet.

The vent hose collar is placed in the rear vent outlet.

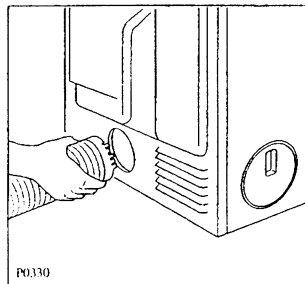

Remove the collar by pulling it out of the vent outlet. Screw the collar to the vent hose.

Fit the hose into the required vent outlet and stop the unused outlets with the covers provided for such a purpose.

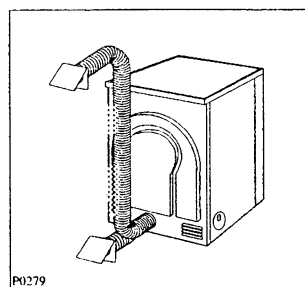

The vent hose must not contain more than two bends when it is placed in position for operation.

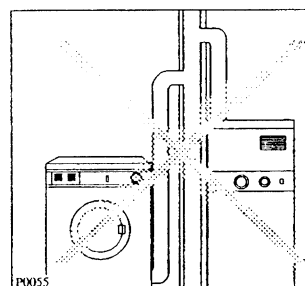

You should **NOT** connect the flexible vent hose to, for example, a chimney or flue pipe designed to carry the exhaust from a fuel burning heating appliance.

The tumble dryer must be installed in a clean place, where dirt does not build up.

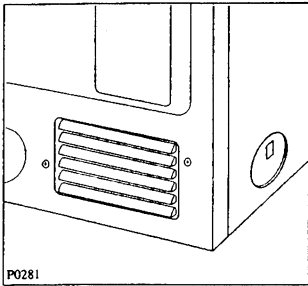

Make sure there are no obstructing items or material near the air-intake louvres provided at the back (e.g. paper, rags etc.).

### Important

When operating the tumble dryer, the room temperature must not exceed 35°C, as it may affect the performance of the appliance.

To save energy, the room temperature should not be lower than +15°C.

### Levelling

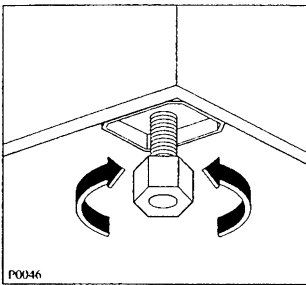

Level the tumble dryer into place by screwing or unscrewing the front feet as required.

Accurate levelling will keep vibration and noise to a minimum when the dryer is in use.

### Door reversal

To make it easier to load or unload the laundry the door can be reversed.

**This operation must be carried out by qualified personnel.**

Operate as follows:

- Remove the door by unscrewing the two screws (1) fastening the hinge to the cabinet (Fig. A).
- Remove the safety catch (2) and the plug (3) by bending the two fastening tags (Fig.A).
- Refit the safety catch (2) and plug (3) on the door by reversing their positions (Fig.B).
- Remove the plastic plate (4) by unscrewing the two fastening screws (Fig. A)
- Refit the plastic plate (4) on the opposite side (Fig.B)
- Refit the door by screwing in the two screws (1) which fasten the door to the cabinet (Fig. B).

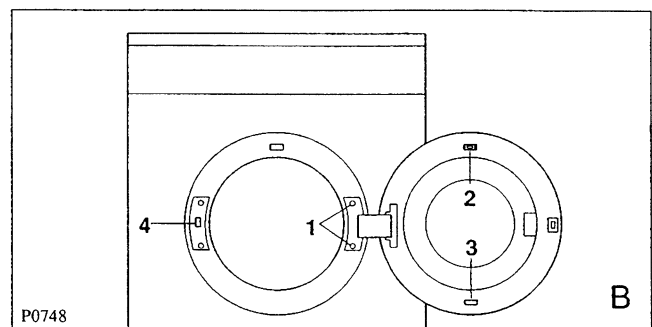
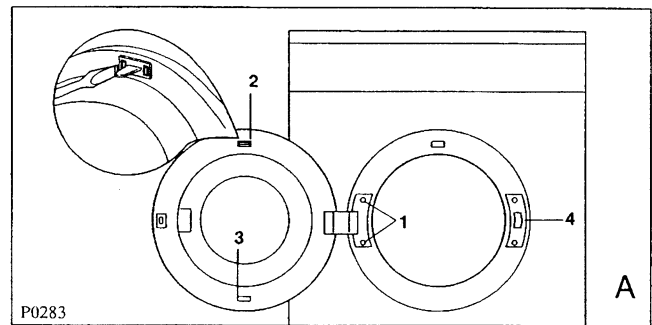

## Electrical Connections

### **WARNING: THIS APPLIANCE MUST BE EARTHED.**

**The manufacturer declines any liability should this safety measure not be observed.**

If the plug that is fitted to your appliance is not suitable for your socket outlet, it must be cut off, and the appropriate plug fitted.

Remove the fuse from the cut off plug. The cut off plug should then be disposed of to prevent the hazard of electric shocks, in case it should be plugged into a 13 Amp socket in another part of your home.

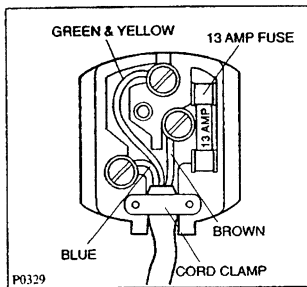

### **IMPORTANT**

The wires in the mains lead are coloured in accordance with the following code:

Green and Yellow - Earth

Blue - Neutral

Brown - Live

If you fit your own plug,

the colours of the wires in the mains lead of your appliance may not correspond with the markings identifying the terminals in your plug.

To fit the plug, proceed as follows:

Connect the green and yellow (earth) wire to the terminal in the plug which is marked with the letter «E» or the earth symbol  $\perp$  or coloured green and yellow.

Connect the blue (neutral) wire to the terminal in the plug which is marked with the letter «N» or coloured black.

Connect the brown (live) wire to the terminal in the plug which is marked with the letter «L» or coloured red.

The plug moulded on to the lead incorporates a fuse. For replacement, use a 13 Amp BS1362 fuse. Only ASTA or BSI approved fuses should be used.

The plug must not be used if the fuse cover/carrier is lost. The cover/carrier is indicated by the coloured insert at the base of the plug.

A replacement cover/carrier must be obtained from your local Electrolux Service Centre whose address is at the back of this book.

Avoid connecting the tumble dryer to the same socket as your washing machine (or any other appliance) by means of an adaptor. Have an extra socket installed if necessary, by a qualified electrician.

---

CE This appliance complies with the following E.E.C. Directives:

- 73/23 EEC of 19.2.73 (Low Voltage Directive) and subsequent modifications;

- 89/336 EEC of 3.5.89 (Electromagnetic Compatibility Directive) and subsequent modifications.

---

### **Note**

Installation, and, in particular, connection to the electric mains and to the discharge vent must be carried out by a competent person or qualified electricians.

Please ensure that when the appliance is installed it is easily accessible for the engineer, in the event of a breakdown.

## Control panel

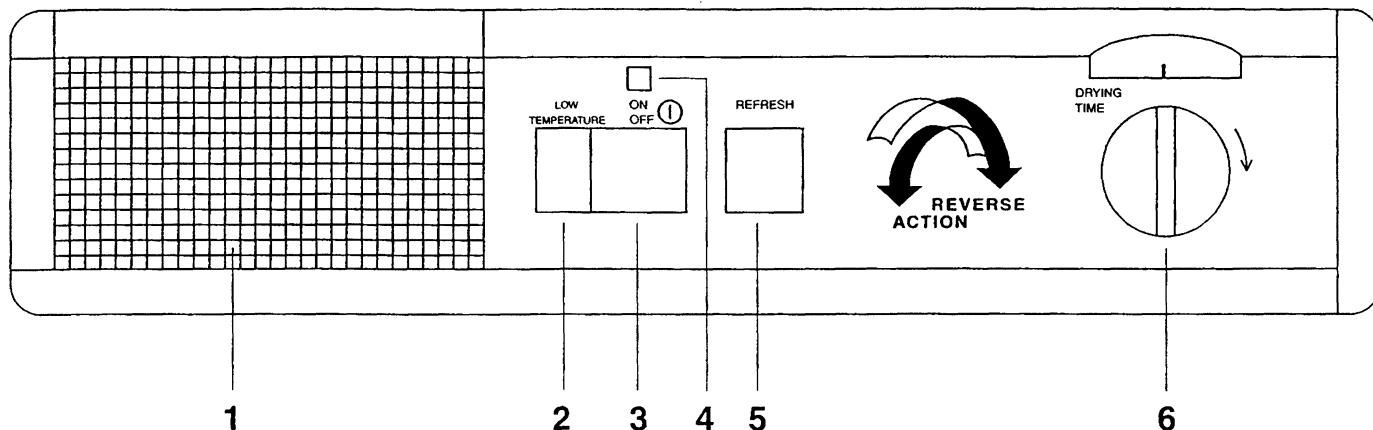

## USE OF CONTROLS

### 1. Programme Chart

This will help you to select the correct time for drying.

### 2. Low Temperature Button

Press this button to reduce temperature when drying cottons or linens.

In this case you should select a longer drying time. On the programmes for synthetics the temperature is automatically reduced.

Therefore it is not necessary to depress this button.

### 3. On/Off Button

Press this button after selecting the drying time to start the machine up.

Press it again to switch the machine off.

### 4. Mains On Light

This lights up when the On/Off button is depressed and will go out when it is pressed again.

### 5. Refresh Button

By depressing this button the heat is cut off. This is particularly useful to freshen the laundry (e.g. to remove a persistent odour of moth-balls).

### 6. Drying Time Selector Dial

The selector dial is marked with times in minutes corresponding with those on the Drying Times Chart (Page 8).

To set the machine to the selected time, turn the dial clockwise until the time you want coincides exactly with the pointer.

**NEVER** attempt to turn the dial in an anticlockwise direction.

The selector incorporates two drying cycles, one of up to 120 minutes at a high temperature for natural fabrics, and one of up to 80 minutes at a low temperature for synthetic fabrics.

When selecting the drying time, you should remember that it includes a 8 minute cooling phase (position  on the dial).

This phase should not be shortened, stopped or avoided, as this could cause skin burns or damages to the laundry.



### Additional drying

If at the end of the programme, the laundry is still too damp, set the dial for a further period of drying (remembering to take into account the cooling period).

## DRYING TIMES

### Cotton and Linen

Selector dial: up to 120 minutes (orange section)

Degree of drying required and labels on articles	Degree of spin given rpm	Quantity kg	Drying times mins
Store dry 	800-1000	5	80-100
		2.5	55-70
	1200	5	75-95
		2.5	50-65
Iron dry 	800-1000	5	70-90
		2.5	35-50
	1200	5	65-85
		2.5	30-45

 high temperature

### Synthetics

Selector dial: up to 80 minutes (blue section)

Degree of drying required and labels on articles	Degree of spin given rpm	Quantity kg	Drying times mins
Store dry 	500	2	40-50
		1	25-35
		0.5	25-30

 reduced temperature

1) Never overfill the drum (do not load large quilts, for example).

The laundry must be suitably spin dried in your washing machine before being placed in the tumble dryer (500rpm minimum).

Drying times vary according to:

- The type of laundry
- The size of the load
- The degree of spinning prior to drying

Drying times are given as a guide only. Experience will soon enable you to estimate the drying time needed for your usual laundry loads.

Do not start by selecting a long drying time. It is better to determine the required degree of dryness by gradually increasing the drying time.

For a mixed load (cotton and resistant synthetics, for example) select the time for the most delicate fibres and increase it by 10 mins.



## Drying

### 1. Load the laundry

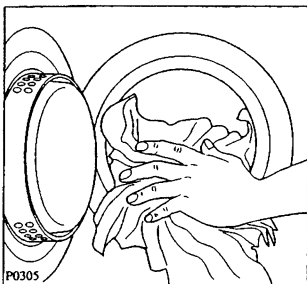

Open the door by pulling it outward.

Load the items one at a time, shaking them out loosely and close the door.

Please check the laundry does not get caught between the door and filter.

### 2. Select time

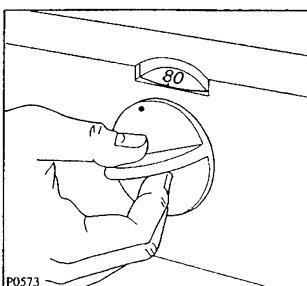

Turn the selector dial clockwise to the required minute setting (in the high or low temperature range, according to the fabric).

### 3. Start the machine

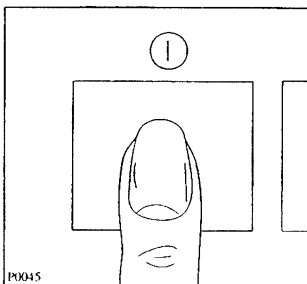

Depress the On/Off button, the mains-on light will illuminate and the dryer starts to work.

### 4. When drying is completed

The machine stops automatically.

If the laundry is still too damp, select a further brief drying time, bearing in mind that during the last 8 minutes the dryer carries out the cooling and anti-crease treatment phase.



Depress the On/Off button and the mains-on light will go out.

**Clean the filter after every drying programme. A clean filter ensures correct functioning of the appliance.**

## Useful hints

- Try to load to the maximum capacity of the machine as small loads are uneconomical. For information, here is a list of the average weights of some common laundry items.

Sheet	700 - 1000 g
Tablecloth	400 - 500 g
Kitchen towel	70 - 120 g
Table napkin	50 - 100 g
Towelling hand towel	150 - 250 g
Bathrobe	1000 - 1500 g
Man's shirt	200 - 300 g
Pillowcase	100 - 200 g
Man's pyjamas	400 - 500 g
Ladies' nightdress	200 - 250 g

- Never tumble dry the following: Particularly delicate items such as net curtains, woollen, silk, fabrics with metal trim, nylon tights, bulky materials such as anoraks, blankets, eider-downs, sleeping bags, feather quilts and any items containing rubber foam or materials similar to rubber foam.
- Always follow the instructions on garment labels.
  -  tumble dry normal (high temperature)
  -  tumble dry delicate (low temperature)
  -  do not tumble dry
- Close pillowcases and covers with fasteners to prevent small laundry items getting tangled inside them. Close press studs, zips and hooks and tie belts and apron strings.
- Sort laundry according to type and degree of drying required.
- Do not over-dry laundry, this avoids creasing and saves energy.
- Avoid drying dark clothes with light coloured fluffy items such as towels as they could attract the fluff.
- Remove the laundry when the dryer has finished drying.
- To avoid a static charge when drying is completed, use either a fabric softener when you are washing the laundry or a fabric conditioner specifically for tumble dryers.

## Laundry Shrinkage

Certain fabrics such as woollens and silks are generally not suitable for tumble drying. Due to the structure of some woollen garments which are recommended for tumble drying, shrinking could still occur, but once the garment is worn again, it should regain its shape.

## Starched Laundry

Starched laundry can also be dried in the tumble dryer. Make sure that the time selected is for iron dry. After completion of the programme wipe out the drum with a damp cloth and dry to remove any traces of starch.

## MAINTENANCE

### Important

You must **disconnect** the appliance from the electricity supply, before you can carry out any cleaning or maintenance work.

### External cleaning

Use only soap and water and then dry thoroughly.

From time to time, apply a little wax furniture cream with a soft cloth.

**Important:** do not use methylated spirit, diluents or similar products.

### Cleaning the door

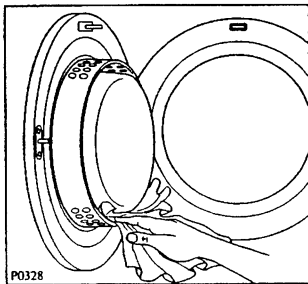

Clean periodically the interior part of the door to remove any fluff. Accurate cleaning ensures correct drying.

### Cleaning the filter

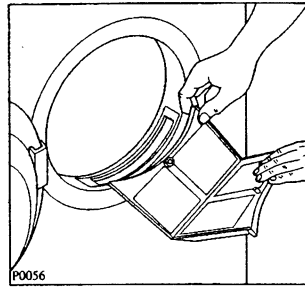

Your dryer will only function well if the filter is clean.

The filter collects all the «fluff» which accumulates during drying and it must therefore be removed and cleaned at the end of each programme.

The filter is composed of two parts to facilitate cleaning.

To remove the filter it is sufficient to lift it up.

It is perfectly normal for fluff to accumulate in the filter during drying. In fact, even fabrics dried in the open air lose their fibres, but we do not notice it.

## SERVICING

**Before contacting your local Electrolux Service Centre, please make the following checks:**

### The dryer does not start up

- The door is open
- The plug is not fitted into the wall socket
- There is no electricity supply from the wall socket
- The time selector dial is not set correctly
- The On/Off switch has not been depressed

### The dryer does not dry properly

- The filter is clogged
- Insufficient drying time
- Excessive laundry load
- The dryer is not correctly installed

If, after the above checks, there is still a fault, call your local Electrolux Service Centre, whose address is at the back of this book.

Please make sure you give the model and serial number of the appliance.

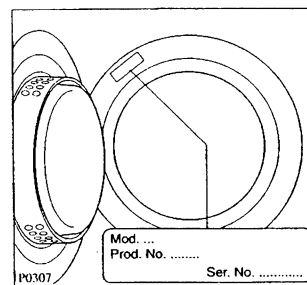

This information can be found on the rating plate (see picture) or on the guarantee card.

Original spare parts can be purchased from Electrolux Service Centres.

**In-guarantee customers should ensure that the above checks have been made as the engineer will make a charge if the fault is not a mechanical or electrical breakdown.**

**Please note that proof of purchase is required for any in-guarantee service calls.**

---

# ELECTROLUX GUARANTEE CONDITIONS

---

We, Electrolux, undertake that if within 12 months of the date of the purchase this Electrolux appliance or any part thereof is proved to be defective by reason only of faulty workmanship or materials, we will, at our option repair or replace the same FREE OF ANY CHARGE for labour, materials or carriage on condition that:

- The appliance has been installed correctly and used only on the electricity supply stated on the rating plate.
- The appliance has been used for normal domestic purposes only, and in accordance with the manufacturer's operating and maintenance instructions.
- The appliance has not been serviced, maintained, repaired, taken apart or tampered with, by any person not authorised by us.

All service work under this guarantee must be undertaken by a Electrolux service representative or authorised agent.

Any appliance or defective part replaced shall become the property of Electrolux.

This guarantee is in addition to your statutory and other legal rights.

Home visits are made between 8.30 am and 5.30 pm Monday to Friday. Visits may be available outside these hours in which case a charge will be made.

## Exclusions

This guarantee does not cover:

- Damage or calls resulting from transportation, improper use or neglect, the replacement of any light bulbs or removable parts of glass or plastic, or vacuum cleaner drive belts, brushes or dust bags.
- Costs incurred for calls to put right an appliance which is improperly installed or calls to appliances outside the United Kingdom.
- Appliances found to be in use within a commercial environment, plus those which are subject to rental agreements.
- Products of Electrolux manufacture which are not marketed by Electrolux.
- EEC Countries. The standard guarantee is applicable but subject to the owner's responsibility and cost to ensure the appliance meets the standards set by the country to which the product is taken. Proof of purchase may be required. Electrolux Aftersales Service in the country concerned, will be pleased to advise further.

## Electrolux After Sales Service - Service Centre Addresses 05/04/95

CENTRE	POSTAL DISTRICTS	SERVICE APPOINTMENTS	ADDRESS
<b>ABERDEEN</b>	AB	01224-696569	Electrolux After Sales Service Northeast Appliance Service 8 Cornhill Arcade Cornhill Drive Aberdeen AB2 5UT
<b>ARGYLL</b>	PA 24-61	01369-703161	Electrolux After Sales Service T.D.C. Refrigeration Briar Hill 7 Hill Street Dunoon Argyll PA 23 7AL
<b>BARNSTAPLE</b>	EX 18-23 31-39	01271-328826	Electrolux After Sales Service McBain Refrigeration Unit 4 Upcott Avenue Pottington Industrial Estate Barnstaple N.Devon EX31 1HN
<b>BORDERS</b>	TD	01573-224411	Electrolux After Sales Service James Stewart & Son 2-8 Wood Market Kelso Borders TD 5 7AX
<b>BRISTOL</b>	BA BS TA SP	0117-9211876	Electrolux After Sales Service Unit BE46 PO Box 372 Bristol BS 99 1UD
<b>CANVEY</b>	E EC EN N NW W WC AL CB HA HP LU MK SG UB WD CM CO IG RM SS IP NR PE 14-19,30-38	0181-443-3464 0181-965-9699 0181-9659699 01268-694144 01603-667017	Electrolux After Sales Service 2-4 Sandhurst Kings Road Canvey Island SS8 0QY
<b>CARDIFF</b>	CF NP 1-4, 6, 9-44 SA 1-18 SA 21-32	01222-460131	Electrolux After Sales Service Guardian Industrial Estate Clydesmuir Road Tremorfa Cardiff CF2 2QS
<b>CUMBRIA</b>	CA	01288-594747	Electrolux After Sales Service E.T.B. Services Carlisle Enterprise Centre James Street Carlisle CA2 5AP
<b>DUMFRIES &amp; GALLOWAY</b>	DG 1-14	01387-265166	Electrolux After Sales Service Allan Crossan (Service) 93 Irish Street Dumfries Scotland

## Electrolux After Sales Service - Service Centre Addresses 05/04/95

CENTRE	POSTAL DISTRICTS	SERVICE APPOINTMENTS	ADDRESS
DUNDEE	DD1-14 PH8-18	01250-876285	Electrolux After Sales Service I Brogan Domestic 41 Leslie Street Blairgowrie Perth shire PH 10 6AT
GLASGOW	EH FK G KA KY1-16 ML PA 1-23 PH 1-7	0141-6474381	Electrolux After Sales Service 20 Cunningham Road Clyde Estate Rutherglen Glasgow G73 1PP
GUERNSEY	All Codes	01481-46931	Guernsey Electricity PO Box 4 Vale Guernsey Channel Island
HAVERFORDWEST	SA33-39, SA41-44, SA61-73	01473-710914	Electrolux After Sales Service C Butherway 1 Church Road Roch Haverfordwest Dyfed SA 62 6AG
HEREFORD	HR1-9 LD1-8 SY7,18 NP5, NP7, NP8	01432-340334	Electrolux After Sales Service Domestic Repair Centre Unit 3 Bank Buildings Cattle Market Hereford HR4 9HX
HULL	YO4 YO11-18 YO25 HU1-19 DN14	01482-58567	Electrolux After Sales Service John Sizer Unit 1, Boulevard Unit Factory Estate Hul HU3 4AY
INVERNESS	IV1-28, 30-36, 52-56 PH19-26, 42-44 KW1-14	01463-792952	Electrolux After Sales Service Highland Appliances Unit 3B3 Smithton Industrial Estate Smithton Inverness
INVERNESS	PH30-41 IV40-51	01855-821315	Electrolux After Sales Service George Ross Electrical Forrestry Workshop Inchree Onich Inverness-shire PH33 6SE
ISLE OF WIGHT	PO30-41	01983-872552	Electrolux After Sales Service Wyatts Electrical Service 4 Forelands Road Bembridge Isle of Wight PO35 5XW

## Electrolux After Sales Service - Service Centre Addresses 05/04/95

CENTRE	POSTAL DISTRICTS	SERVICE APPOINTMENTS	ADDRESS
ISLE OF ARRAN	KA27	01770-302909	Electrolux After Sales Service Arran Domestic Unit 4 The Douglas Centre Brodick Isle of Arran KA27 8AJ
ISLE OF MAN	IM	01624-663455	Electrolux After Sales Service Manx Electricity Service Workshop North Quay Douglas Isle of Man
ISLE OF MULL	PA62-75	01688-302262	Electrolux After Sales Service B Hogg Braeside Raeric Road Tobermory Isle of Mull PA75 6PU
JERSEY	All Codes	01534-505050	Jersey Electricity Company PO Box 45 Queens Road St Helier Jersey, Channel Islands JE4 8NY
LAMPETER	SA19, 20 SA 40 SA45-48 SY23-25	01570-423020	Electrolux After Sales Service Lampeter Domestic Appliance Service Unit 16 Lampeter Industrial Estate Lampeter SA48 7DY
LANCASTER	LA1-23	01772-316175	Electrolux After Sales Service NL Services Unit 333 Ranglet Road Walton Summit Bamber Bridge Preston, Lancashire PR5 8AR
LEEDS	BD DN1-7, 10-12 HD HG HX LS S WF YO1-3, 5-8 DE NG1-22 & 25	0113-2608511	Electrolux After Sales Service 64-66 Cross Gates Road Leeds LS15 7NN
LINCOLN	DN21 subcd. 1, 2 & 5 only LN1, 2, 4-6 LN3 subcodes 4 & 5 only LN8-10 NG23, 24 31-34 PE 1-13, 20-25	01522-514603	Electrolux After Sales Service Brian Hudson Unit 8 Stonefield Park Clifton Street Lincoln LN 5 8AA
LIVERPOOL	FY PR L WN CH CW WA (Not WA14/15)	0151-2541724	Electrolux After Sales Service Unit 1 Honeys Green Precinct Honeys Green Lane West Derby Liverpool L12 9JH

## Electrolux After Sales Service - Service Centre Addresses 05/04/95

CENTRE	POSTAL DISTRICTS	SERVICE APPOINTMENTS	ADDRESS
<b>MANCHESTER</b>	BB BL OL M SK WA14 & 15 only,	0161-4777758	Electrolux After Sales Service Unit 30 Oakhill Trading Estate Devonshire Road Worsley Manchester M28 3PT
<b>NEWTON ABBOTT</b>	EX1-17 PL1-9, 16, 19-21 TQ	01626-65909	Electrolux After Sales Service South West Domestic Service Unit 2 Zealley Industrial Estate Kingsteignton Newton Abbott South Devon TQ12 3SJ
<b>NORTH WALES</b>	LL	01745-591616	Electrolux After Sales Service GMS (Cymru) Unit 2 Coed - Parc Abergele Road Rhuddlan Clwyd, Wales LL18 5UG
<b>NORTHERN</b>	DL TS DH YO21,22 DH NE SR	01325-301400 0191-493-2025	Electrolux After Sales Service PO Box 40 Preston Road Aycliffe Industrial Estate Newton Aycliffe, Co Durham DL5 6XA
<b>NORTHERN IRELAND EAST</b>	BT1-30,36-57,63-67	01232-746591	Electrolux After Sales Service Unit C3 Edenderry Industrial Estate 326 Crumlin Road Belfast BT14 7EE
<b>NORTHERN IRELAND WEST</b>	BT31-35, 60-62 BT68-82, 92-94	01861-510400	Electrolux After Sales Service G & O (Armagh) Service Owenmore House Kilwee Business Park Upper Dunmurray Lane, Belfast BT17 0HD
<b>NUNEATON</b>	B DY ST TF WR WS WV GL NN OX SN CV LE	0121-358-7076 0121-358-5051 01993-704411 01203-350420	Electrolux After Sales Service Unit 23-24 Alliance Business Park Townsend Drive Nuneaton Warwickshire CV11 6RX
<b>ORKNEY</b>	KW15-17	01856-875457	Electrolux After Sales Service Refrigeration Sales and Service Hatson Ind. Estate Kirkwall Orkney
<b>REDDITCH</b>	TBA	TBA	Electrolux After Sales Service Heming Road Washford Redditch Worcestershire B98 0DH

**Electrolux After Sales Service - Service Centre Addresses 05/04/95**

<b>CENTRE</b>	<b>POSTAL DISTRICTS</b>	<b>SERVICE APPOINTMENTS</b>	<b>ADDRESS</b>
<b>REDRUTH</b>	TR1-20, 26, 27 PL10-15, 17, 18, 22-35	01209-314407	Electrolux After Sales Service Cornwall Domestic Service Unit 7D Pool Industrial Estate Wilson Way Redruth, Cornwall TR15 3QW
<b>ROTHSAY</b>	PA20	01700-504777	Electrolux After Sales Service D McGlashan Walker Walker Engineering Glenmhor Upper Serpentine Rothesay PA20
<b>SHETLAND</b>	Own Sales	01595-692225	Electrolux After Sales Service Tait Electronic Systems Ltd Holmsgarth Road Lerwick Shetland ZE1 OPW
<b>SHETLAND</b>	Own Sales	01595-692855	Electrolux After Sales Service Bolts Shetland Ltd 26 North Road Lerwick Shetland ZE1 OPE
<b>SHETLAND</b>	ZE2	01806-566546	Electrolux After Sales Service Leask Electrical Harsdale Symbister Shetland ZE2 9AA
<b>SHREWSBURY</b>	SY1-6 SY8-17 SY19-22	01743-450279	Electrolux After Sales Service BLI Service 6 Harlescott Barn Harlescott Lane Shrewsbury, Shropshire SY1 3SY
<b>SOUTH COAST</b>	BN16-18.GU27-35 P01-22.BH DT SO TR21-25	01705-667411 01705-667411 0117-9211876	Electrolux After Sales Service Limerline Road Hilsea Portsmouth Hampshire PO3 5JJ
<b>SOUTH HUMBERSIDE</b>	DN8, 9 DN15-20 DN21 subcodes 3, 4 only DN31-40 LN3 subcode 6 only,7 LN11-13	01472-2267978	Electrolux After Sales Service John Robinson (Electrical) Unit 74 New Enterprise Centre King Edward Street Great Grimsby DN31 3JP
<b>TONBRIDGE</b>	SL GU1-26.RG CT DA ME TN BN1-15 20-27 RH TW BR CR SE SW SM KT	01252-24505 01732-357722 01273-694341 0181-658-9069	Electrolux After Sales Service Unit 30 Deacon Trading Estate Morley Road Tonbridge Kent TN9 1RA









