

LAVATHERM 37320 ELECTRONIC

Vented Tumble Dryer

Operating Instructions

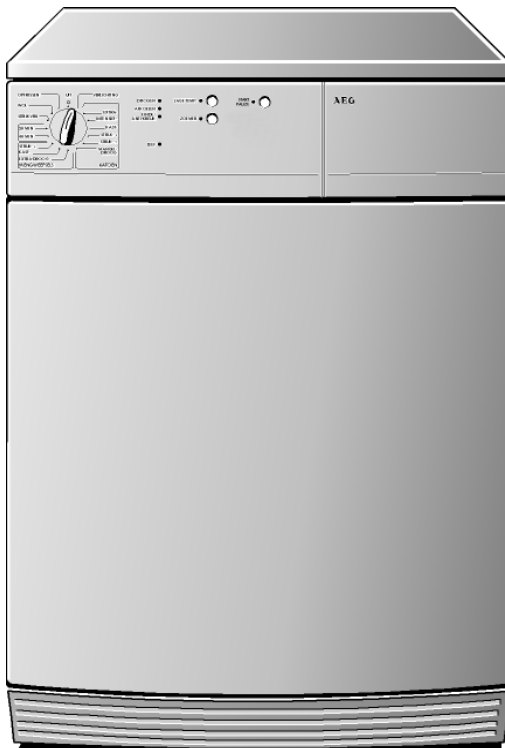

Dear customer,

Please read these operating instructions through carefully, before using the appliance.

Please ensure you fully understand the safety instructions on the first pages of these operating instructions! Retain this instruction book for future reference, and pass on to any future owners.



The warning triangle and/or the key words (**Warning!**, **Caution!**, **Important!**), emphasize information which is important for your safety or the correct functioning of the appliance. It is essential that this information is observed.



This symbol guides you step by step when operating the appliance.



This symbol gives additional information and practical tips on using the appliance.



Tips and information about the economical and environmentally friendly use of the machine are marked with the clover symbol.

- These operating instructions contain information about how to independently solve any problems which may arise. See "What to do if ...".

Printed on environmentally friendly paper ...
Whoever thinks ecologically also acts ecologically.

Content

Important Safety Information	5
General Safety	5
Child Safety	6
Installation	7
General Information	8
Disposal	8
Packaging	8
Environmental protection tips	9
Description of the appliance	11
Front view	11
Control panel	12
The programme selector positions	13
Before using the appliance for the first time	13
Brief operating instructions	14
Drying	15
Prepare the laundry	15
Open the door	15
Load the laundry	15
Closing the door	15
Select the drying programme	15
Start the drying programme	16
Removing laundry or loading laundry when necessary	17
End of the drying process	17
Removing the laundry	17
Cleaning the door seal	17
Clean the fluff filter	18
Switch-off the dryer	18
Programme tables	19
A small glossary of textile information	21
Care symbols	21

Cleaning and maintenance	22
Cleaning the filter area	22
Cleaning the drum	23
Cleaning the panel and operating parts	23
Cleaning the door seal	23
What to do if	24
Replacing the interior light	25
Door Reversal Instructions	26
Technical data	28
Installation and electrical connection	28
Information for the electrician	28
Special accessories	29
Vent hose	29
Stacking kit	29
Site Preparation	30
Venting	31
Venting through a Vent Hose	32
Venting without a Vent Hose	33
Index	34
Service	35



Important Safety Information

Your safety is of paramount importance, please ensure you read these warnings before installing or using the appliance. If you are unsure about any of the meanings of these warnings, contact the Customer Care Department.

General Safety

- Any electrical work required to install this appliance should be carried out by a qualified electrician or competent person.
- Please follow the safety information in the installation section of this instruction book.
- This appliance is designed to dry normal domestic laundry. If the appliance is used for any other purpose or is incorrectly used, the manufacturer accepts no liability for any damages which may result.
- Switch off the appliance and isolate from the mains supply before carrying out any maintenance or cleaning work.
- If the appliance will be out of operation for an extended period of time, unplug it from the mains.
- Never operate the appliance if the mains cable is damaged or if the control panel, work top or base area are damaged allowing internal components to be accessible.
- Do not spray the tumble dryer with water.
- Do not dry textiles which have been treated with flammable cleaning agents and solvents.
- Clothes or articles of laundry which are dripping wet should not be placed in the dryer. Only load well-spun laundry.
- Laundry items containing sponge rubber or rubber-like materials must be not be dried in the tumble dryer.
- If the drying cycle is interrupted, the laundry or drum may be hot.
- Do not use the tumble dryer without the bulb cover in position.
- Do not operate the appliance with a damaged filter or with no filter at all.
- Do not overload the appliance.
- When closing the door, please check that the washing is not caught in it.
- It is dangerous to alter the specifications or attempt to modify this product in any way.

- Adaptors and extension cables must not be used. There is risk of fire because of overheating!
- Do not use the mains cable to pull the plug out of the socket.
- Repairs to the appliance should only be carried out by qualified personnel. Repairs carried out by inexperienced persons may cause injury or serious malfunction. Contact your local AEG Service Force Centre for repair.
- Washing that is in poor condition (heavily worn) and items with loose fillings (cushions) that could break open must not be dried or refreshed. There is a risk of fire!
- Washing with rigid components (foot mats) will cover the air slots; the slots will also be covered if the drum is overfilled. Observe the maximum load of 5 kg. There is a risk of overheating which could cause a fire!
- Only dry washing that does not contain any explosive objects (fire lighters, spray cans). There is a risk of fire or an explosion!
- Clean the fluff filter after each drying procedure.
- In the case of washer / dryer tower combinations, do not place any objects on the dryer during use as they could drop down.

Child Safety

- The appliance is designed to be operated by adults. Children should not be allowed to tamper with the controls or play with the appliance.
- Pets and children have been known to climb into tumble dryers. Please check the drum before use.
- Keep all packaging away from children.
- When disposing of the appliance, cut off the mains cable and destroy the plug. Disable the door catch to prevent young children being trapped inside.

Installation

- Check the appliance for transportation damage before installation.
- Any electrical work required to install this appliance should be carried out by a qualified electrician or competent person.
- If the tumble dryer has to be carried, first remove the plinth!
- Do not install the appliance on deep pile carpet.
- This tumble dryer is designed to be vented through to the open air. It should have its own ventilation system which should not be joined with any other ventilation system connected to any other appliance.
- The dryer must not be vented into a chimney, or flue pipe designed to carry the exhaust from a fuel burning heating appliance.
- If the tumble dryer is installed next to a fuel burning stove, a heat insulation non-flammable pad must be inserted between the fuel burning stove and the tumble dryer; (dimensions 85 x 57.5 cm).
- If the dryer is installed in a room with a fuel burning heating appliance, consult your local Corgi registered installer.
- The tumble dryer should not be installed in situations which may be subject to freezing temperatures.
- The installation site must be well ventilated.
- Ensure the appliance does not stand on the electrical supply cable.
- If the machine is situated on carpeted floor, please adjust the feet in order to allow air to circulate freely.
- Ensure the appliance is level.
- Observe the safety precautions in the operating instructions for your dryer.
- Air is drawn in through vents at the rear and front of this appliance. Therefore, keep the area around the appliance clear.

General Information

- Starched washing leaves traces of starch on the drum and therefore should not be placed in the tumble dryer.
- If you exceed the maximum load stipulated in the programme table your washing is more likely to get creased! For very delicate fabrics you should only fill in 1.5kg washing at the most.
- For your information: 70 per cent of fabric wear is caused by being worn, 20 per cent by washing and only 10 per cent by being dried in a tumble dryer. As the fabric is worn down, fluff gathers in the fluff filter. When using a tumble dryer, only approx. 0.03g fluff per kilogramme washing is produced.

Disposal

Packaging

Dispose of the packaging material!

Dispose of the packaging material of your tumble dryer correctly. All the packaging materials used are harmless to the environment and can be recycled.

- Plastic parts are marked with standard international abbreviations:
 - >PE< for polyethylene, e.g. sheet wrapping material
 - >PS< for polystyrene, e.g. padding material (always CFC-free)
 - >POM< for polyoxymethylene, e.g. plastic clips

Cardboard packaging is manufactured from recycled paper and should be deposited in the waste paper collection for recycling.

Disposal of the old appliance!

When you eventually stop using your tumble dryer please bring it to the nearest recycling centre or to your dealer who will take it back for a small fee.



Warning! When disposing of the tumble dryer, pull out the plug, cut off the flex, dispose of the plug and remaining flex and destroy the door lock. This hinders children from locking themselves in and endangering their lives.

The materials can be recycled in accordance with their markings. Standard tools (crosshead screwdriver, hammer) are sufficient to dismantle the old appliance.



Environmental protection tips

- Your laundry will become light and soft in the laundry dryer even without a soft rinsing agent.
- Loosen your laundry before loading it into the dryer. This helps to prevent lengthy running times and creasing.
- Ensure your laundry is well spun.

In the following table we give an overview of specific electric consumption data depending on the spinning speed. This information is valid for 5kg laundry dried with the programme COTTONS STORAGE DRY:

Pre-drying:			Drying process:	
Revolutions per minute	Residual moisture		Required time in minutes	Power consumption in kWh
	in Litres	in %		
800	3.5	70	80	3.3
1000	3.0	59	70	2.9
1200	2.7	53	65	2.6
1400	2.5	50	60	2.4
1600	2.2	44	55	2.2

- Ensure that the room is well ventilated!
- Observe the maximum load instructions. Whenever possible, dry full loads.

- Choose the right drying programme for the type and quantity of laundry. The dryer will then operate as economically as possible. Some typical consumption values:

Drying programme	Fill weight in kg	Duration in Minutes	Power consumption in kWh
COTTONS STORAGE DRY ¹	5	80	3.3
COTTONS HAND IRON ¹	5	65	2.5
EASY CARES STORAGE DRY ²	2.5	35	1.3

1) spun at 800 revolutions per minute

2) spun at 1000 revolutions per minute

If the amount of laundry is not enough for a particular degree of drying (e.g. HAND IRON), you should dry it in stages for best economy: Fill the dryer and select the programme HAND IRON; after the end of this programme take out your laundry for ironing. Finally dry the remaining laundry with the programme STORAGE DRY.

- Only use the SPECIAL CARE button for loads up to 2.5kg!
- Clean the fluff filter after every drying programme!

Description of the appliance

Front view

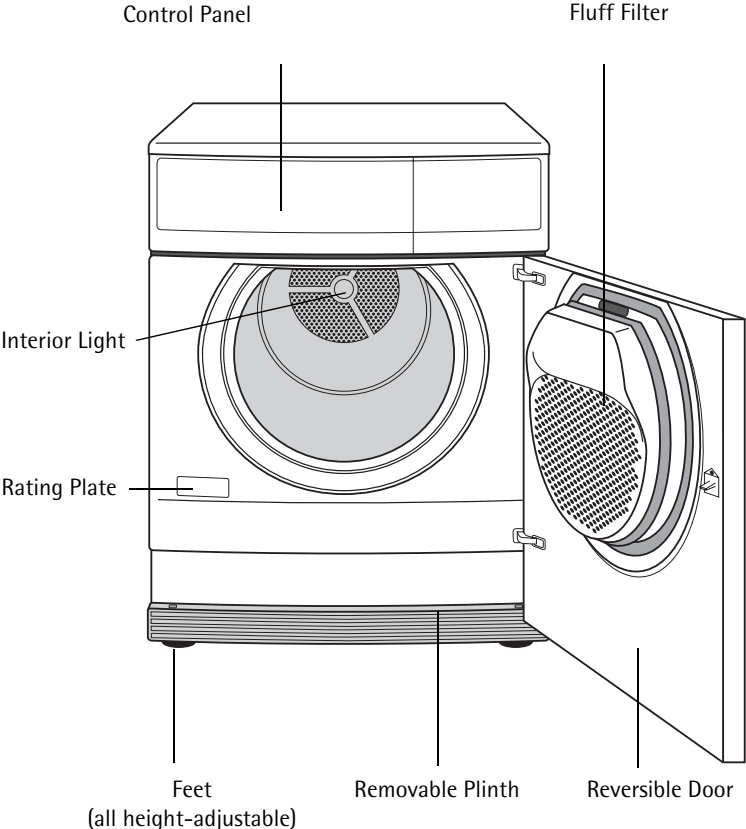

Control panel

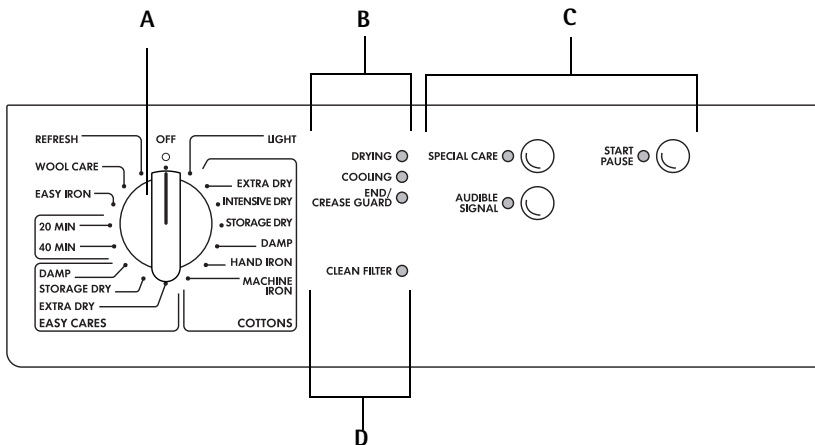

A Programme selector: To select the drying programme

B Programme run display: In each case the display for the current phase of the drying process is lit.

C Buttons and display block

- SPECIAL CARE button: For sensitive fabrics.
- AUDIBLE SIGNAL button: When switched-on, an audible signal is sounded at the end of the drying programme; then take-out the laundry
- START/PAUSE button: To start or interrupt the programme.

D Instructions for the user:

- CLEAN FILTER display: Clean the fluff filter!

The programme selector positions

- **OFF:**
The tumble dryer is switched off.
- **LIGHT:**
The drum light switches on when the door is opened.
- **Programme group COTTONS:**
Programmes for drying cotton and linen fabrics;
maximum load 5 kg.
- **Programme group EASY CARES:**
Programmes for drying mixed fabrics and synthetics;
maximum load 2.5 kg.
- **Time Programmes:**
For additional drying or for drying loads of less than 1 kg.
- **EASY IRON programme:**
Special drying programme with anti-crease mechanism for easy-care fabrics;
maximum load 1 kg.
- **WOOL CARE programme:**
To freshen up woollen fabrics after they have been line dried;
maximum load 1 kg.
- **REFRESH programme**
For optimum results when refreshing items of clothing and gently cleaning textiles with the aid of commercially available dry-cleaning products (please follow the manufacturer's instructions for use);
Programme duration: 35 minutes;
maximum load 1 kg.

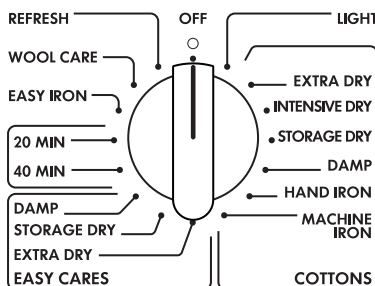

Before using the appliance for the first time

-  Wipe out the drum using a damp cloth or else insert damp cloths and carry out a short drying procedure (20 mins.).

Brief operating instructions

- Ensure the laundry is well spun before tumble drying.
- Prepare the laundry.
- Open the door and load the laundry.
- Shut the door.
Attention! Do not catch washing in the door.
- Select the drying programme on the programme selector.
- Press the SPECIAL CARE or AUDIBLE SIGNAL button if required
- Start the programme by pressing the START/PAUSE-button.

While the programme is running you can open the door to take-out laundry or add more laundry.

At the end of the programme (END / CREASE GUARD display is illuminated, acoustic signal is heard, if set, the anti-crease phase begins):

- Remove the laundry.
- Clean the fluff filter.
- Switch-off the dryer by turning the programme selector to the OFF position.

Drying

Prepare the laundry

- To prevent tangled bundles of laundry: Close zip fasteners; button-up bed linen and pillow cases; tie-together loose tapes, e.g. aprons.
- Empty all pockets.
- Remove all metal objects (i.e. paper clips, pins, etc.).
- Turn clothing consisting of double-layer fabric inside out (such as cotton-lined anoraks with the cotton layer facing outwards). The fabrics will dry better.
- Loosen the laundry.

Open the door

To open the door:

- Press firmly against the door (Press position ).

Load the laundry

- Load the prepared laundry into the dryer.

Closing the door

Closing the door:

- apply pressure to the door until it clicks audibly into place.





Caution! Ensure the laundry does not get caught in the door when the door is closed! This could damage the laundry!

Select the drying programme

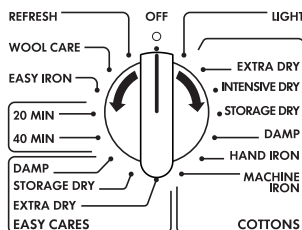

Select the suitable drying programme using the programme selector (see "Programme tables").



 If required, select the buttons SPECIAL CARE or AUDIBLE SIGNAL.

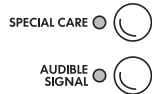

- **SPECIAL CARE button**
This programme operates with reduced heat. Press the SPECIAL CARE button for fabrics bearing the care symbol . Gentle drying is advisable for heat-sensitive fabrics (such as acrylic and viscose).
- **AUDIBLE SIGNAL button**
During the crease-protection phase (immediately after the drying phase), an acoustic signal is sounded at intervals (see "End of drying process").

Start the drying programme

 Press the START / PAUSE button.

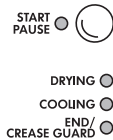



The drying programme starts. The programme progress is indicated on programme phase display.

Removing laundry or loading laundry when necessary

You can interrupt the drying process at any time to remove some of the laundry or to add more laundry.

 Open the door.

 **Caution!** The laundry and the drum may be hot.

 Remove or add more laundry.

 Close the door.

 Press the START / PAUSE button to resume the drying process.

End of the drying process

The **cooling phase** starts shortly before the end of the drying process: The heater is switched-off during this phase.

After the cooling phase the END / CREASE GUARD display is illuminated. You can now remove the washing from the tumble dryer.

The **crease guard phase** follows automatically after the drying process. The drum rotates intermittently. This keeps your laundry loose and crease-free.

If you have pressed the AUDIBLE SIGNAL button, an acoustic signal is sounded intermittently during this phase.

You should remove the washing at the latest towards the end of the anti-crease phase to avoid creasing.

Removing the laundry

 Open the door and remove the laundry.

Cleaning the door seal

 Rub the door seal with a damp cloth.

Clean the fluff filter

To ensure efficient operation of the tumble dryer, clean the fluff filter after each drying programme.

Also check whether there are any remnants or fluff from the washing in the drum; remove immediately.

- ☞ Press the catch of the filter lid downwards.

The filter lid will open.

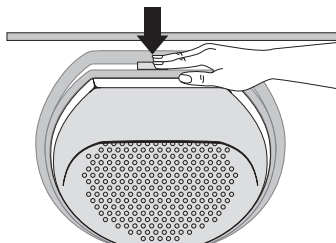

- ☞ Take-out the fluff filter.

- ☞ Remove fluff out of the fluff filter, with a moistened hand.

- ☞ Re-insert the fluff filter.

- ☞ Press against the filter lid until it catches into the locking device.

- i** The filter lid cannot catch shut without the fluff filter in place and the door cannot be closed.

- !** **Warning!** The dryer must not be operated with a damaged or blocked fluff filter.

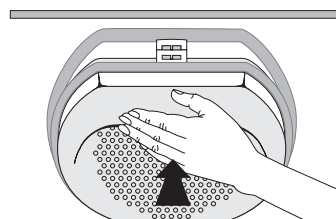
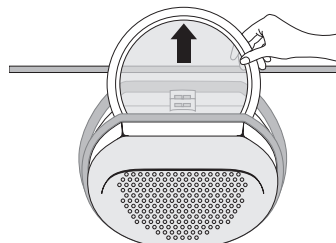



Switch-off the dryer

- ☞ Turn the programme selector to the OFF position.



Programme tables

Programme group COTTONS

care symbols , ; maximum load 5 kg

Programme	Laundry Type	Examples for
EXTRA DRY	Heavy weight or multi-layered fabrics	Towelling material, bath robes
INTENSIVE DRY	Thick textiles that are to be thoroughly dried.	Towelling, terry towels
STORAGE DRY	Fabrics of medium weight, articles not made up of multi-layers	Towel laundry, hand towels
DAMP	Lightweight materials requiring ironing	Cotton shirt and underwear
HAND IRON	Normal cotton and linen articles	Sheets and pillowcases, tablecloths
MACHINE IRON	Cotton and linen articles, to be ironed by rotary ironer or starched laundry	Cotton sheets and pillowcases, tablecloths

Programme group EASY CARES

care symbols , ¹, ; maximum load 2.5kg

Programme	Laundry Type	Examples for
EXTRA DRY	Heavy weight or multi-layered fabrics	Sweatshirts, bed linen and table linen
STORAGE DRY	Lightweight materials which do not require ironing	Easycare fabric shirts, table linen, baby clothes, socks and underwear
DAMP	Lightweight synthetics and cotton/polyester mixtures requiring ironing	Bed and table linen, easycare fabric shirts and blouses

1) Press the SPECIAL CARE button!

Time programmes

care symbols  ¹, ; loads less than 1 kg

You can select 20 and 40 minutes programme duration for additional drying of individual pieces of laundry or to dry small quantities.

1) Press the SPECIAL CARE button!

EASY IRON programme

care symbols  ¹, ; maximum load 1 kg (approx. 5-6 shirts)

For drying fabrics such as shirts and blouses; minimal ironing required.

Result depends on type and finish of fabric.

Recommendation: spin fabrics in the washing machine at a speed of about 1200 revolutions and then transfer immediately to the dryer. Remove fabrics immediately after drying and hang on a hanger.

1) Press the SPECIAL CARE button!

WOOL CARE programme

maximum load 1 kg

To freshen up the wool fibres of woollen garments after they have been line dried, worn or stored for longer periods they can be treated briefly using warm air. The wool emerges beautifully soft.

Recommendation: remove fabrics immediately after drying.

REFRESH programme

maximum load 1 kg





For optimum results when refreshing items of clothing and gently cleaning textiles with the aid of commercially available dry-cleaning products (please follow the manufacturer's instructions for use);

Programme duration: 35 minutes.

A small glossary of textile information

Care symbols

Ensure articles to be dried are suitable for tumble drying. If they are one of the following symbols should be present on the care label:

-  Normal drying
-  Drying with special care (press the SPECIAL CARE button!)
-  This fabric can be tumble dried. The fabric manufacturer does not stipulate if the piece of laundry should be dried on a normal or gentle programme.
-  Do not tumble dry

If you do not find any of these care symbols:







Dry whites and coloureds as well as mixed fabrics at normal temperature. Press the SPECIAL CARE button if you are drying delicate fabrics.

- Wool
Do not dry any woollen items in the dryer.
As a follow-up treatment for woollen fabrics in quantities up to 1 kg select the WOOL CARE programme.
- Fabrics sensitive to temperatures
Dry fabrics sensitive to temperatures (such as acrylic or viscose) and textiles with the care label  with the SPECIAL CARE button selected.
- Cotton jersey and hosiery have a tendency to shrink! Do not dry these fabrics excessively.
- New coloured textiles
To avoid the possibility of dye transference do not dry new coloured textiles together with light-coloured laundry.

Cleaning and maintenance

Cleaning the filter area

 **Important!** When the CLEAN FILTER display illuminates, it is essential to clean the fluff filter. Otherwise your dryer might suffer damage. A small amount of fluff may reach the area around the filter in spite of the fluff filter. Therefore you should clean the entire filter area from time to time, or at least every three months.

-  Remove the fluff filter.
-  Hold the filter lid by the top and pull it forwards until it is released from both holders.
-  Remove the fluff from the entire filter area – preferably with a vacuum cleaner.
-  Press both pins of the filter lid into the holders on the door until they click in.
-  Reinsert the fluff filter.
-  Press against the filter lid until it clicks into the lock.

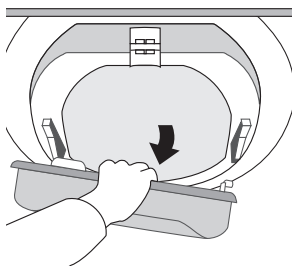

Cleaning the drum



Warning! Do not clean the stainless steel drum with abrasive detergents or steel wool!

Fabric softeners or lime in the water can cause a scarcely visible deposit to form on the drum. The dryer is then no longer reliably able to recognise how dry the washing is. When the washing is removed from the dryer it will be damper than you expect.



Wipe the inside of the drum and the drum fins with white vinegar to avoid any residues/deposits effecting the sensors. This is particularly important if you regularly use fabric conditioning sheets or dry starched items in the dryer.

Cleaning the panel and operating parts



Warning! Do not use household furniture polish or aggressive detergents.



Wipe over the panel and operating parts with a damp cloth. Only use warm water.

Cleaning the door seal



Rub the door seal with a damp cloth immediately after the drying procedure.

What to do if ...

If the tumble dryer is not working correctly please carry out the following checks before calling out an engineer.

Symptom	Possible cause	Solution
The tumble dryer will not start	The appliance is not plugged in	Plug in the appliance
	The fuse has blown	Check the fuse
	The START/PAUSE button has not been pressed	Press the START/PAUSE button
	No programme has been selected	Select the required programme
	The door is not properly closed	Close the door
The results are unsatisfactory	The wrong programme has been selected	Select a different programme
	Fluff filter blocked	Clean the fluff filter
	The tumble dryer has been overloaded	Observe the maximum loads stated for each programme
	Laundry not sufficiently spun prior to tumble drying	Ensure the wash load is well spun before tumble drying
	A residue may have formed on the drum interior, blocking the sensors	Clean the inside of the drum with white vinegar
The drum illumination does not work	Is the tumble dryer plugged in	Plug in the tumble dryer
	The programme selector is in the OFF position	Turn the programme selector dial to LIGHT
	The bulb needs replacing	Replace bulb
The door cannot be closed	Fluff filter has not been inserted correctly and/or the filter lid not closed	Replace the fluff filter and ensure the filter lid is closed

Symptom	Possible cause	Solution
The dryer ends the drying process automatically: END is displayed shortly after programme start	Too dry or too little laundry is in the drum for the selected programme	Select time programme or higher drying stage (e.g. EXTRA DRY instead of INTENSIVE DRY)
The drying process takes unusually long. Note: The drying cycle ends automatically after 3 hours: - DRYING and COOLING indicators are flashing - acoustic signal sounds	The vent hose may be obstructed	Check the vent is not blocked or squashed
	Fluff filter is clogged	Clean the fluff filter
	SPECIAL CARE button pressed and too much laundry in the drum	Check the programme selection: SPECIAL CARE button appropriate only for laundry amounts up to 2.5kg
	Too much laundry in the drum	Reduce the amount of laundry in the drum
	Laundry too damp	Pre-dry (spin) the laundry more thoroughly

If after these checks, the tumble dryer still does not work, contact your local AEG Service Force Centre.

Please note that it will be necessary to provide proof of purchase for any in-guarantee service calls.

In-guarantee customers should ensure that the above checks have been made as the engineer will make a charge if the fault is not a mechanical or electrical breakdown.

Replacing the interior light

 A replacement bulb can be purchased through your local AEG Service Force Centre (Part No: 899647072580/6).

 **Warning!** Never use standard light bulbs in your Lavatherm.

 Isolate the appliance from the mains supply.

 Unscrew the bulb cover. (The bulb is located at the top behind the door; see *Front view*).

 Replace the defective bulb.

 Screw on the bulb cover.

 **Warning!** For safety reasons the bulb cover must be screwed on. The dryer must not be operated, without the cover in place.

Door Reversal Instructions







The door opening direction can be changed if required.

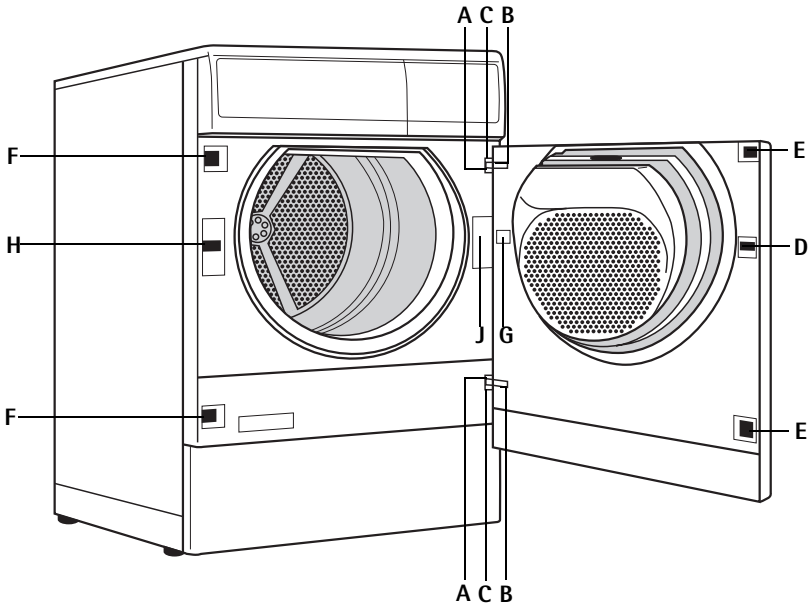





Warning! Before reversing the door, isolate the appliance from the mains supply.

Proceed as follows to reverse the door opening direction:



-  Unscrew the screws A on the front panel of the appliance.
-  Take off the door by sliding it out horizontally.
-  Unscrew the screws B on the inside of the door and take off the hinges C.
-  Unscrew and take-off the locking block D.
-  Release the coverplates E, F and G with a thin screwdriver by pressing on the latching device, releasing them on one side. Take them out and insert them on the opposite side.
-  Screw on the hinges C and the locking block D on the opposite side of the door.
-  Unscrew the door catch H, take it out and pull off the plug.

-
-  Take out the latched catch covering J and pull off the plug.
 -  Connect the door catch H and the catch covering J on the respective opposite side to the plug, insert into the hole and screw-down or latch into position.
 -  Push the door with the hinges into the holes provided for them in the front panel of the appliance and firmly attach it with the screws.
-  **Warning!** The appliance is safe again for operation only when all plastic parts have been mounted.

Technical data

HeightxWidthxDepth	85x60x60cm
Depth with the door open	117cm
Height adjustable from	1.0/-0.4cm
Empty weight	approx. 40kg
Load (depending on the programme)	max. 5kg
Power consumption in acc. with IEC 1121 s.e. (5 kg Cotton, spun at 800 revolutions per minute, program COTTONS STORAGE DRY)	3.3kWh
Area of use	Household
Permissible ambient temperature	+5°C up to +35°C

- CE** This appliance complies with the following EC directives:
- 73/23/EEC of 19/2/1973 'Low voltage directive'
 - 89/336/EEC of 3/5/1989 'EMC directive' including the Modification directive 92/31/EEC

Installation and electrical connection

See accompanying booklet "Installation Instructions for Vented Tumble Dryer"

Please refer to the type plate for specifications about the power supply. The nominal voltage stated on the type plate and type of current must be identical with the nominal voltage and type of current at the point of installation. Also refer to the type plate for the fuse required.

Information for the electrician

When connecting the appliance without a plug, care must be taken that this is done correctly. Please follow the relevant information in the section on installing and connecting the appliance.

For appliances with variable voltage settings, the switch-over diagram can be found on the cover of the connection box at the back of the appliance.

Special accessories

You can obtain the following special accessories from your retailer:

Vent hose

To conduct exhaust fumes, a flexible spiral conduit with a diameter of 105 mm can be obtained through your AEG Service Force Centre or at a specialised electrical shop. This spiral conduit is easy to fit and is easily attached to the vented tumble dryer using the adapter that comes with the appliance (see enclosed booklet „Installation Instructions for Vented Tumble Dryer“).

Stacking kit

With these kits you can combine your laundry dryer with any LAVAMAT automatic washing machine to a washing and drying column. The appliances are stacked in space-economising manner in this arrangement, the washing machine at the bottom and the laundry dryer at the top.

The following two kits are available:

- | | |
|---------------------------------|-------------------|
| - without plate | E-No. 916 018 900 |
| - with extendible deposit plate | E-No. 916 018 901 |

Site Preparation

- The installation surface must be clean and dry.
- Do not install on a deep pile carpet.
- If the appliance is installed next to a heat source (e. g. cooking appliance), a heat insulation pad (85 x 57 cm) must be placed between the washing machine and the heat source.
- Do not install the appliance where the temperature may fall below freezing or rise above 35°C.
- Please ensure that when the appliance is installed it is easily accessible for the engineer in the event of a breakdown.

Levelling the Appliance

The appliance must be levelled using the adjustable feet. Use a screwdriver to adjust to the feet until the appliance is level.

Venting

The appliance expels hot, moist air which must be able to flow freely from the tumble dryer vent.

Tumble Dryer Vents

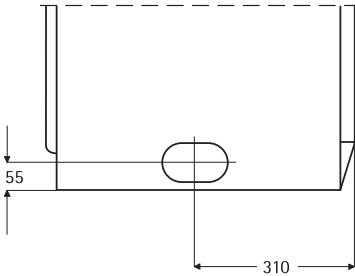

View from left

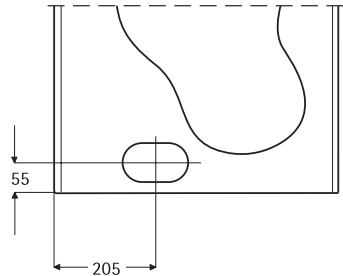

Rear view

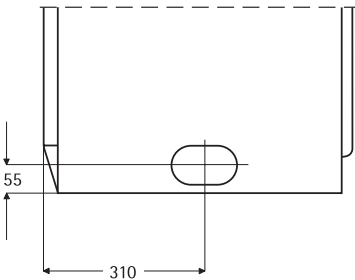

View from right

The most efficient way of venting the expelled air is via a vent hose through to the outside.

Venting through a Vent Hose

The vent hose expelling the hot air should have a 100 mm diameter and be no longer than 4 meters. Avoid bends in the vent hose as this will reduce the air flow. The maximum length of the vent hose may be: 4 meters with 0 bends, or 2 meters with 2 bends.

If the vent hose is to be permanently installed to the outside, a wall box or suitable cover should be used on the outside wall.

Example:

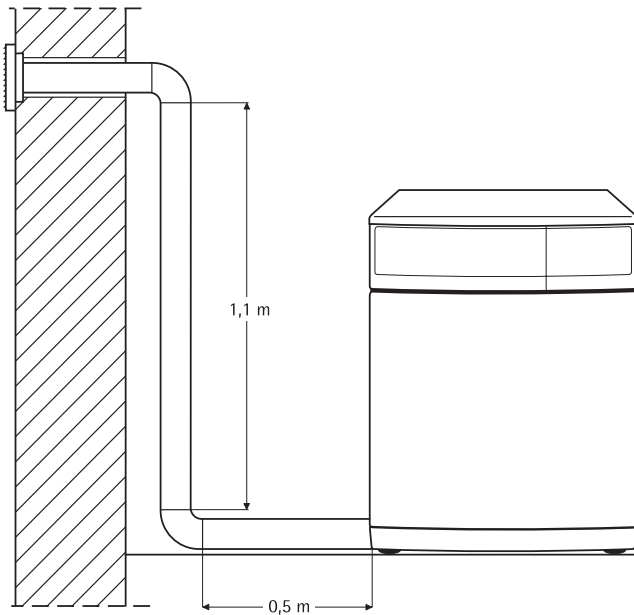

A vent hose (Part number: 899647000010/1) and wall box (Part number: 899647000020/0) are available from your local AEG Service Force Centre.

Ensure the vent hose is not squashed. The drying efficiency of the tumble dryer will be affected and may cause the safety cut outs to operate.



Warning! The vent hose must not be connected to a flue pipe or chimney designed to carry the exhaust from a fuel burning heating appliance.

Venting without a Vent Hose

If a vent hose is not connected to the tumble dryer, the air can be expelled into the room where the appliance is located providing the following precautions are observed.

- The vent(s) in use must be at least 30 cm from the wall or any other object.
- Any vent less than 30 cm from a wall or other object must be closed using the cover provided.
- The installation room must be well ventilated during the drying cycle.

Index

A

Acrylate	16
Acrylic	21
Anorak	15
AUDIBLE SIGNAL	16, 17

C

Closing the door	18
Control panel	12
Cool-down phase	17
Crease protection phase	17
Creasing	8
Customer service	35

D

Delicate fabric	8
Door	26

E

EASY IRON	13, 20
Easy-care fabrics	21

F

Fabric softeners	23
Fabric wear when drying	8
Filter area	22
Fluff filter	18
Fluff quantity	8
Front view	11
Full load, specified	8
Furniture polish	23

G

Glossary	21
----------------	----

I

Installation	7
Interior light	25
Ironing	10

L

Lime	23
------------	----

O

Opening the door	15
------------------------	----

P

Packaging	8
-----------------	---

R

REFRESH	13, 20
---------------	--------

S

Safety Information	5
SPECIAL CARE	16
Stacking kit	29
Starched washing	8
START	16

T

Two-layer fabric	15
------------------------	----

V

Viscose	21
---------------	----

W

Wool	21
WOOL CARE	13, 20

Service

In the chapter "What to do if ..." some disturbances have been summarised, which you can solve yourself. If you do not find any helpful information there, please contact your local customer service centre. It is nearby and if necessary can reach you quickly. (Addresses and phone numbers can be found in the Warranty Conditions/Service Departments)

Be well prepared before you phone. This facilitates the diagnosis and the decision as to whether a customer service visit is necessary. With our checklist you can gather important information before making your call:

Make a note of the PNC number and the S number. They are both on the rating plate behind your tumble dryer's door.

PNC

S-No

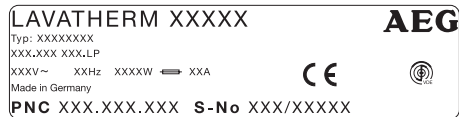

If possible establish:

- How is the disturbance evident?
- Under what circumstances does the disturbance occur?

When do you incur costs even during the warranty period?

- if you could have solved the disturbance yourself with the help of the Troubleshooting table (see section "What to do if ..."),
- if the customer service engineer has to make several journeys because he did not receive all the necessary important information before his visit and now e.g. has to fetch spares. You can avoid these extra trips by preparing your telephone call properly in the way described above.

 **From the Electrolux Group. The world's No. 1 choice.**

The Electrolux Group is the world's largest producer of powered appliances for kitchen, cleaning and outdoor use. More than 55 million Electrolux Group products (such as refrigerators, cookers, washing machines, vacuum cleaners, chain saws and lawn mowers) are sold each year to a value of approx. USD 14 billion in more than 150 countries around the world.

AEG Hausgeräte GmbH
Postfach 1036
D-90327 Nürnberg

<http://www.aeg.hausgeraete.de>

© Copyright by AEG

822 944 349-00- 0903/PRO

Subject to change without notice