

Aussie[®] by Meco[®]

Monaro[®] Charcoal Grill Assembly and Use Manual



Model 7652K1



Model 7652K5 & 7652K6

FOR OUTDOOR HOUSEHOLD USE ONLY. NOT FOR COMMERCIAL USE.

For Customer Service, call 1-800-251-7558 or visit our web site at www.meco.net

WARNING

- Failure to follow these instructions could result in fire or explosion which could cause property damage, personal injury or death.
- Read and follow instructions carefully before assembly or use.
- **Do not** use this product for any other purpose than which it is intended.
- These instructions must be kept with the user. **SAVE THESE INSTRUCTIONS.**

— NOTICE —

MECO CORPORATION STRIVES TO BE A QUALITY SUPPLIER OF CONSUMER PRODUCTS. IF WE OMITTED ANY PARTS NEEDED FOR ASSEMBLY, OR YOU NEED TROUBLESHOOTING INFORMATION, PLEASE CONTACT US USING OUR TOLL FREE NUMBER. THANK YOU FOR PURCHASING A MECO CORPORATION PRODUCT.

1-(800)-251-7558
8 am - 6 pm E.S.T Mon. - Fri.
1-(423)-639-1171 (TELEPHONE)
1-(423)-639-2570 (FAX)

www.meco.net

CONSUMER SERVICE DEPARTMENT
MECO CORPORATION
1500 INDUSTRIAL ROAD
GREENEVILLE, TN. 37745 USA

CONTENTS

I. Assembly Instructions.....	2	3) Operating the Charcoal Grill.....	13
Parts Illustrations.....	3	4) Starting a Fire.....	13
Parts List.....	4	B) Grill Cooking.....	14
Step 1-Leg/Side Table Assembly.....	5	1) Cooking on the Grids.....	14
Step 2-Bottom Shelf/Leg Assembly.....	6	2) Smoking	14
Step 3-Wheel Assembly.....	7	C) End of Cooking Session.....	15
Step 4-Slide Vent Assembly.....	8	D) Care and Maintenance.....	15
Step 5-Hood Handle Assembly.....	9	1) Cleaning the Grill.....	15
Step 6-Grill Body/Cart Assembly.....	9	a) Drip Tray.....	15
Step 7-Install Drip Pan, Charcoal Grate & Cooking Grid...12		b) Cooking Grid.....	15
II. Operating and Maintaining Your Charcoal Grill.....	13	c) Grill Body.....	15
A) Before Using Your Charcoal Grill.....	13	d) Side Tables and Wood parts.....	15
1) Using Charcoal.....	13	2) Storage.....	15
2) Selecting a Location.....	13		



WARNING

The use of alcohol, prescription or non prescription drugs could impair the consumer's ability to properly assemble or safely operate this appliance.

ASSEMBLY INSTRUCTIONS

PREPARATION FOR ASSEMBLY: Removing parts from carton and some assembly will require **two people**. Before starting assembly, read the instructions and your manual.

Remove all the parts from the carton and lay them on a smooth, clean surface. (You may cut the carton, spread it out, and use it as a pad to protect part finishes.) Look in the Parts List under the model number to find the exact parts you need. Do not throw away any packaging until you have located all the parts.

Follow instructions of each step in the order they are written as you look at the diagrams. This will allow little confusion and easier assembly. If you have any questions which require help, contact Customer Service and be sure to mention the model number of your grill.



CAUTION

To reduce the risk of a cut injury:

- Wear protective gloves when handling parts that have sharp edges.
- Some assembly may require help from another person. Observe where noted.

PARTS ILLUSTRATIONS

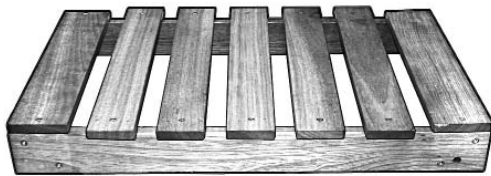
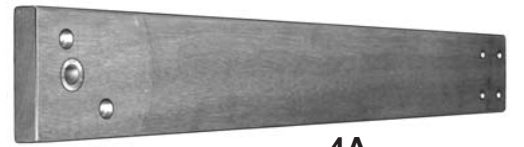
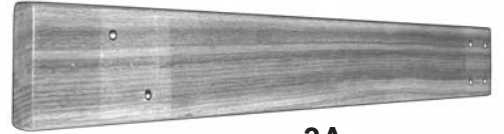

11
11A



18 or 18A



21





25 Hood w/Embossed Logo
25A Hood w/Decal Logo Shown

ITEM	DESCRIPTION	PART #	QTY.		
			Model 7652K1	Model 7652K5	Model 7652K6
	PARTS LIST				
1	Owner's Manual	03.6077.01	1	1	1
2	Side Table (Metal Insert)	03.6495.00	--	2	2
2A	Side Table (Metal Insert)	03.6597.00	--	--	2
2B	Side Table (All Wood)	03.5845.00	2	--	--
3	Fixed Leg (Metal)	03.6496.00	--	2	2
3A	Fixed Leg (Wood)	03.6066.00	2	--	--
4	Wheel Leg (Metal)	03.6497.00	--	2	2
4A	Wheel Leg (Wood)	03.6065.00	2	--	--
5	Bolt, 1/4-20 x 1 3/8"	03.6498.00	--	24	24
5A	Bolt, 1/4-20 x 1 "	03.4062.00	24	--	--
6	Bottom Shelf (Model 7652K5)	03.6499.00	--	1	--
6A	Bottom Shelf (Model 7652K6)	03.6598.00	--	--	1
6B	Bottom Shelf (Model 7652K1)	03.6067.00	1	--	--
7	Axle (Assembled with Item 10 Axle Nut)	03.5014.00	1	1	1
8	Steel Washer, (Axle)	03.4072.00	2	2	2
9	Wheel	03.5003.00	2	2	2
10	Axle Nut (Assembled on Item 7 Axle)	03.4073.00	2	2	2
11	Body Assembly (See 25, 25A & 26 for Replacement)	--	1	1	1
12	Slide Vent	03.6072.00	2	2	2
13	Bolt, 6mm x 16mm	03.6070.00	8	8	8
14	Washer, 6mm	03.6501.00	18	18	18
15	Spacer, Sleeve	03.6071.00	8	8	8
16	Locknut, 6mm	03.4070.00	10	10	10
17	Bolt, 6mm x 90mm	03.6020.00	2	10	10
17A	Bolt, 6mm x 110mm	03.4066.00	8	--	--
18	Handle, Hood (Models 7652K1 & 7652K5)	03.6036.00	1	1	--
18A	Handle, Hood (Model 7652K6)	03.6599.00	--	--	1
19	Spacer, Handle	03.6023.00	2	2	2
20	Spacer, Body	03.4074.00	8	8	8
21	Wing Nut, M6	03.6003.00	8	8	8
22	Drip Pan	03.6069.00	1	1	1
23	Charcoal Grate	03.6074.00	1	1	1
24	Cooking Grid	03.6075.00	2	2	2
25	Hood (Embossed Logo)	03.6502.00	1	--	--
25A	Hood (Decal Logo)	03.6503.00	--	1	1
26	Body	03.6068.00	1	1	1

TOOLS:  or   and/or 

STEP 1- Leg/Side Table Assembly



(ITEM 2 or 2A Side Table



(ITEM 2B) Side Table



(ITEM 3 or 3A) Fixed Leg

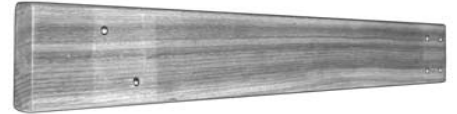

(ITEM 4 or 4A) Wheel Leg



(ITEM 5) 1/4-20 x 1 3/8" Bolt



(ITEM 5A) 1/4-20 x 1" Bolt

- Lay Side Tables upside down on a flat surface. Side tables will fit on either side of grill.
- Attach the two Fixed Legs to one Side Table. Align four recessed holes of a Fixed Leg with four inserted holes in a Side Table. The four large recessed holes in the Fixed Leg should face away from Side Table. Attach four 1/4 -20 Bolts (Item 5 or 5A) through each Fixed Leg into the threaded holes in the Side Table. Do not tighten bolts completely. (NOTE: For easier alignment and further assembly, final tightening of all bolts will be completed in Step 6).
- Attach the two Wheel Legs to the second Side Table the same way. (Wheel Leg is the short leg with a large axle hole at one end.)

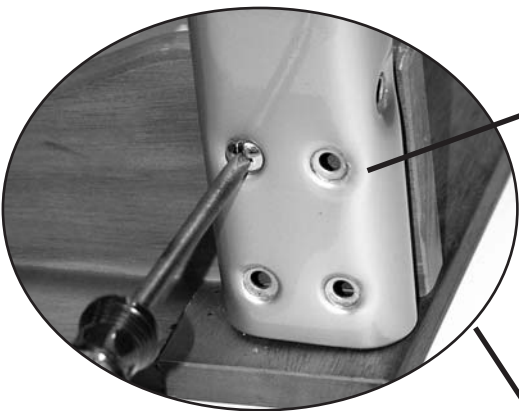

Recessed holes face out



Wood Side Table/Legs

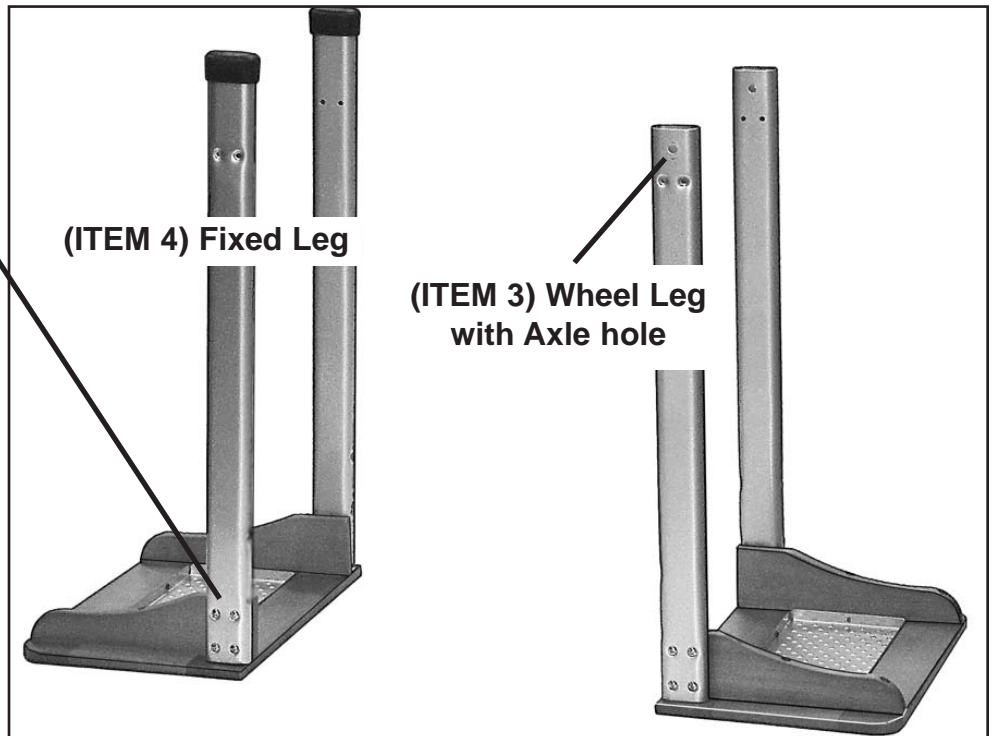

(ITEM 4) Fixed Leg

(ITEM 3) Wheel Leg with Axle hole

STEP 2- Bottom Shelf/Leg Assembly



(ITEM 5)
1/4-20 x 1 3/8" Bolt



(ITEM 5A)
1/4-20 x 1" Bolt



(ITEM 6 or 6A)
Bottom Shelf



(ITEM 6B)
Bottom Shelf

- Place both Leg/Side Table Assemblies opposite each other as shown with Bottom Shelf between them.
- Align Bottom Shelf holes with holes of Wheel Legs and attach with four 1/4-20 Bolts (Item 5 or 5A). Do not tighten Bolts completely.
- Secure Fixed Legs to Bottom Shelf with 1/4 -20 Bolts. Go ahead and tighten Wheel Leg bolts securely. (This will not be possible after the Wheel is assembled.)

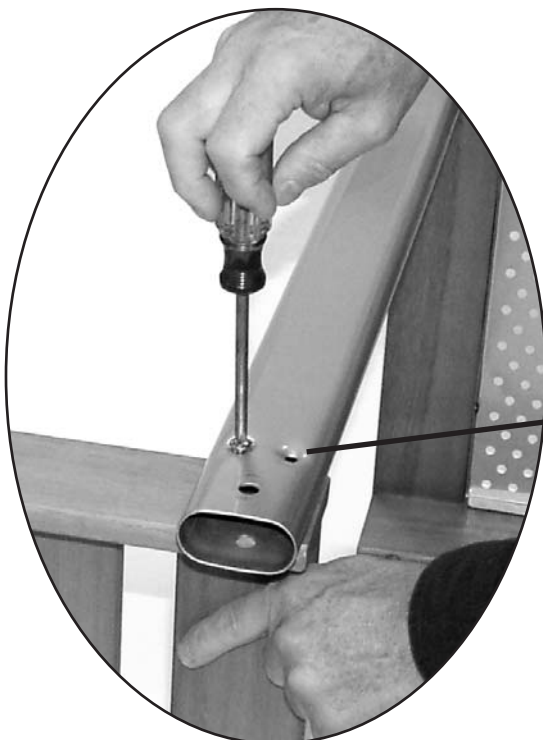
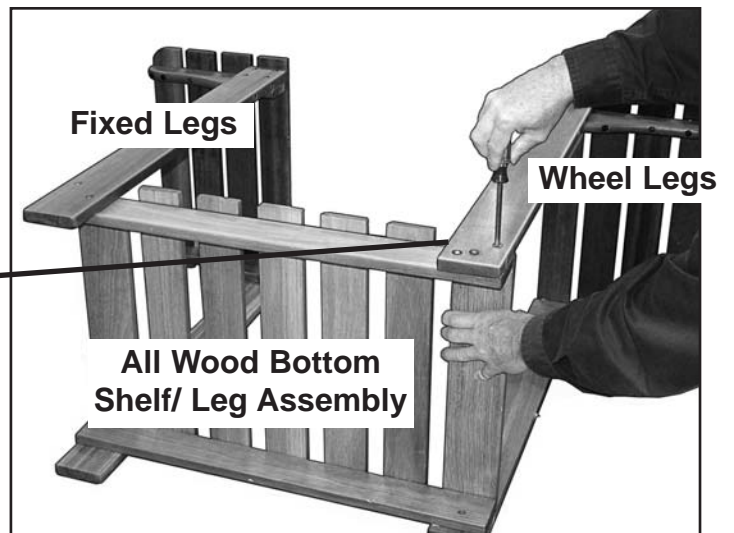
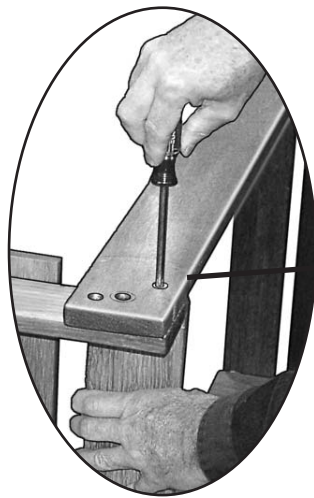

STEP 3-Wheel Assembly

(ITEM 8) Washer
(Axle)



(ITEM 10) Axle Nut



7 with Item 10 installed

(ITEM 9) Wheel

- Remove Axle Nuts from Axle. Insert Axle through both sides of Wheel Legs. Place Axle Washers onto each end of Axle.
- Position Wheel hub recess to the outside and slide a Wheel onto each end of Axle.
- Attach Axle Nut onto each end of Axle. Tighten each side with wrench or pliers.

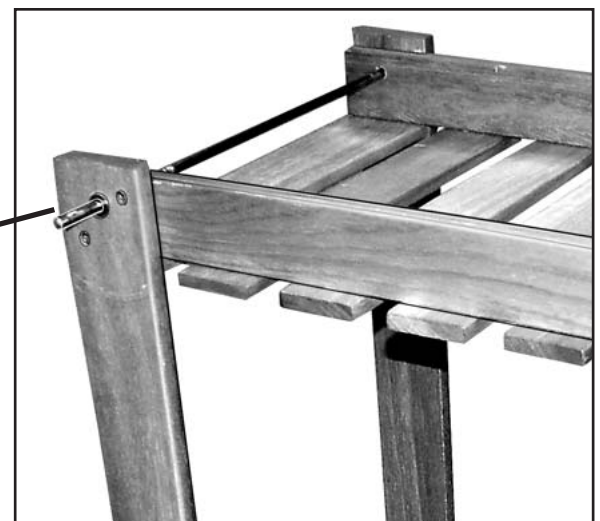
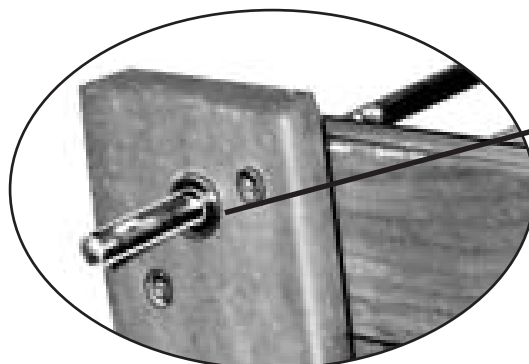
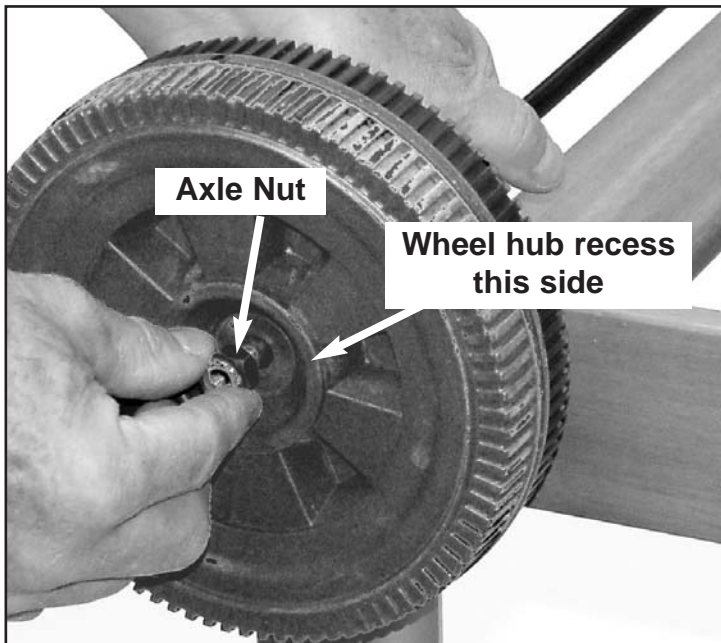
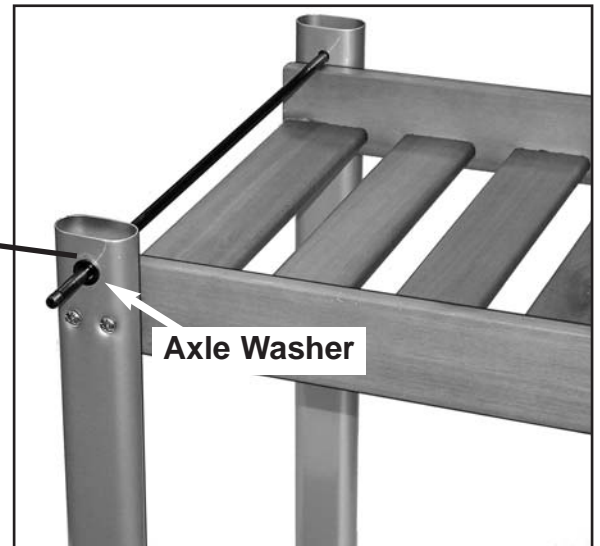
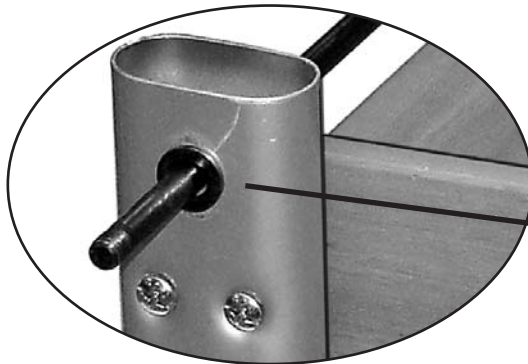

STEP 4-Slide Vent Assembly



(ITEM 11 or 11A)
Body Assembly

(ITEM 12)
Slide Vent



(ITEM 16)
Locknut, 6mm



(ITEM 15)
Sleeve
Spacer, 6mm



(ITEM 14)
Washer, 6mm



(ITEM 13) Bolt, 6mm



- Open the Hood on the Grill Body.
- Align slotted holes in Slide Vent with holes in Grill Body Side.
- Insert a 6 mm x 16 Bolt through the 6mm Steel Washer and Sleeve Spacer. Position this assembly with the Sleeve Spacer inside the Slide Vent slotted hole. Attach 6mm Steel Washer and Locknut to Bolt from inside of Grill Body to secure the Slide Vent. Repeat for each slotted hole on both Slide Vents.
- Make sure the Vents slide back and forth freely over the Sleeve Spacers. If not, loosen the bolts slightly and reset the Spacers inside the Slide Vent slotted holes and retighten.

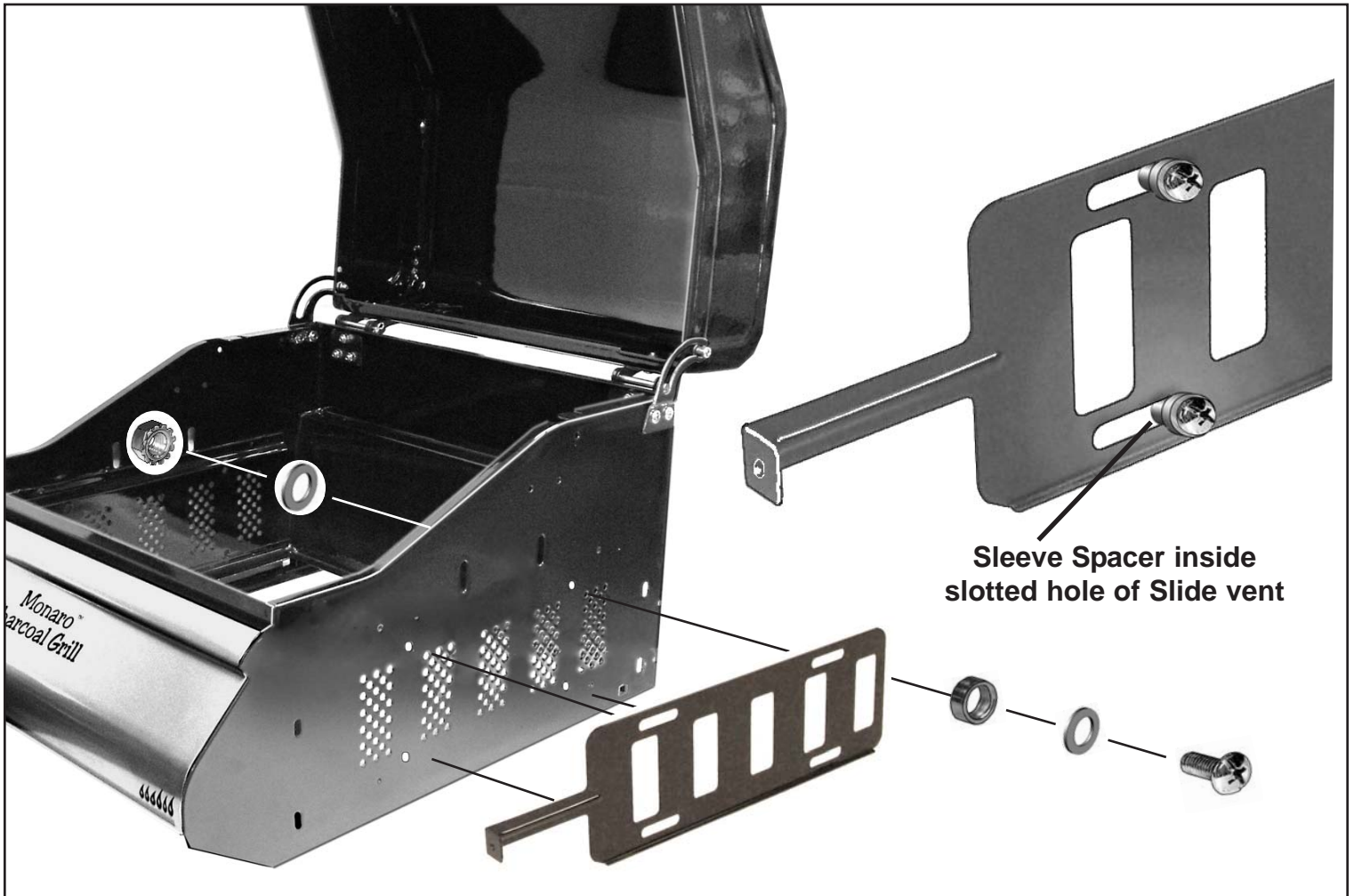

STEP 5-Hood Handle Assembly



(ITEM 17) Bolt, 6mm x 90 mm



(ITEM 18 or 18A) Hood Handle



(ITEM 19) Handle Spacer



(ITEM 14) Washer
6 mm



(ITEM 16) Locknut
6mm

- Open Hood and lay it on on its backside.
- Insert 6 mm x 90 mm Bolt through recessed hole of Hood Handle, through Handle Spacer through a hole in Hood. (Note: Wide end of Handle Spacer goes against the Hood.)
- Attach a 6mm Washer and Locknut to the Bolt from inside Hood. Do not over tighten; it may crack the Hood finish.
- Repeat for other end of Handle.



Assembled Handle

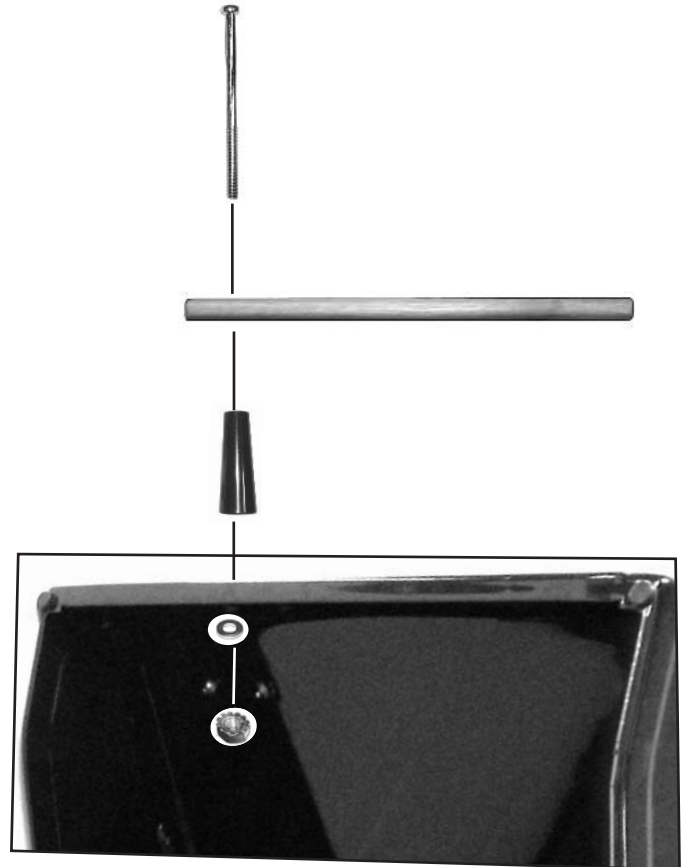

STEP 6-Grill Body/Cart Assembly (Continues on next page)

⚠ CAUTION

Assembly of Grill Body will require two people.



(ITEM 11 or 11A)
Body Assembly



(ITEM 17) Bolt, 6mm x 90 mm



(ITEM 17A) Bolt, 6mm x 110 mm



(ITEM 20) Body Spacer



(ITEM 21) Wingnut, 6mm

STEP 6-Continued Grill Body/Cart Assembly (See also page 11 for Wood Cart Assembly)

- Carefully lay Grill Body Assembly on its back side with Front panel facing up and Hood open. Lay Cart Assembly on the back side with the Grill Body between Side Tables. (Note: Wheels on Cart assembly are to the left.) (FIG. A)
- Align slotted holes on sides of Grill Body Assembly with holes in edges of legs (FIG. B). Insert Body Spacers between Leg and Grill Body. (You can pull the legs away from the body since all the bolts are loose.) Insert two 6mm x 90mm Body Bolts through Leg, Spacers and slotted holes in Grill Body. Attach a 6mm Wing Nut to the Bolts, but do not tighten. Repeat this assembly for remaining three Cart Legs.
- With help from a second person, turn full Grill and Cart Assembly upright. The Grill Body should slide down to seat itself within the slotted holes. If not, loosen the Body bolts and push down at all four corners.
- Tighten all Body Bolts and Wing Nuts.
- Tighten all other Bolts at his time.

View from inside
Body/Cart Assembly

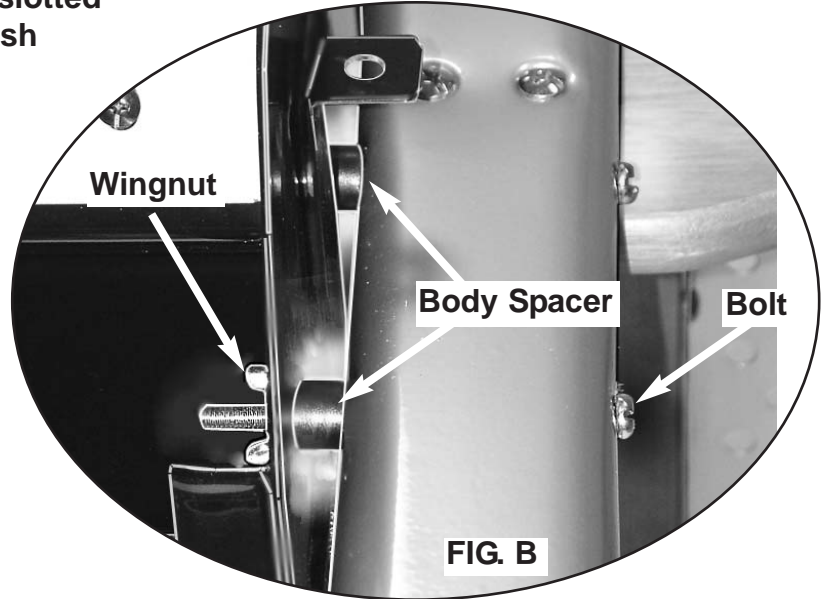

View from back side of
Leg/Body Assembly
after standing up

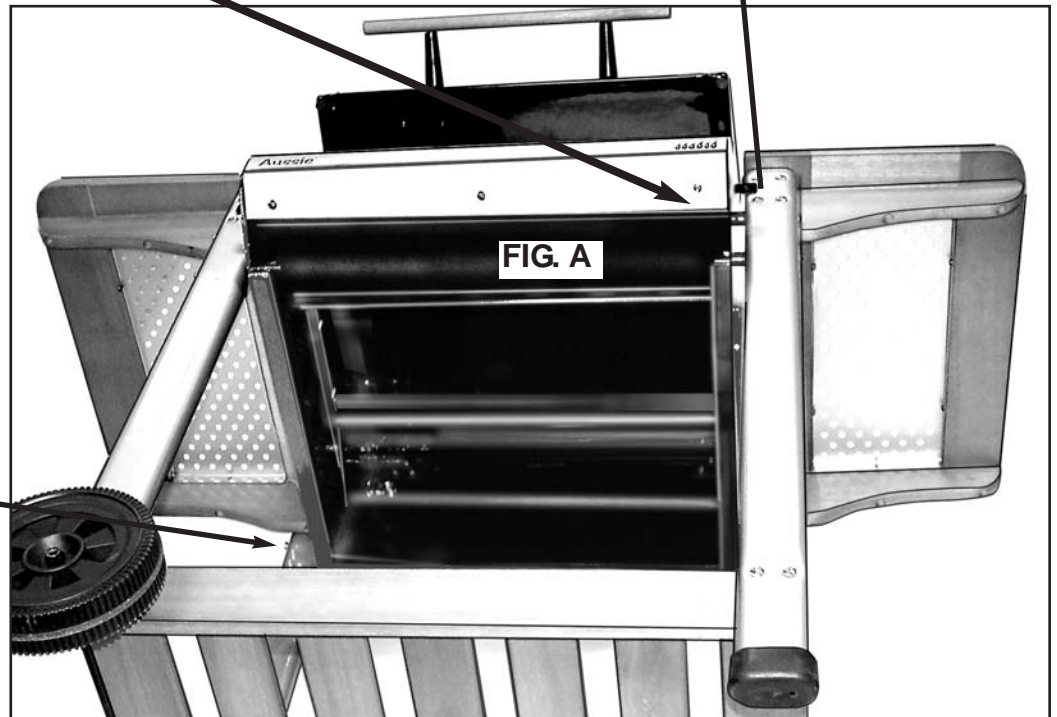

STEP 6-Grill Body/Wood Cart Assembly

**View from inside
Body/Leg Assembly**



**View from back side of
Body/Leg Assembly
after standing up**

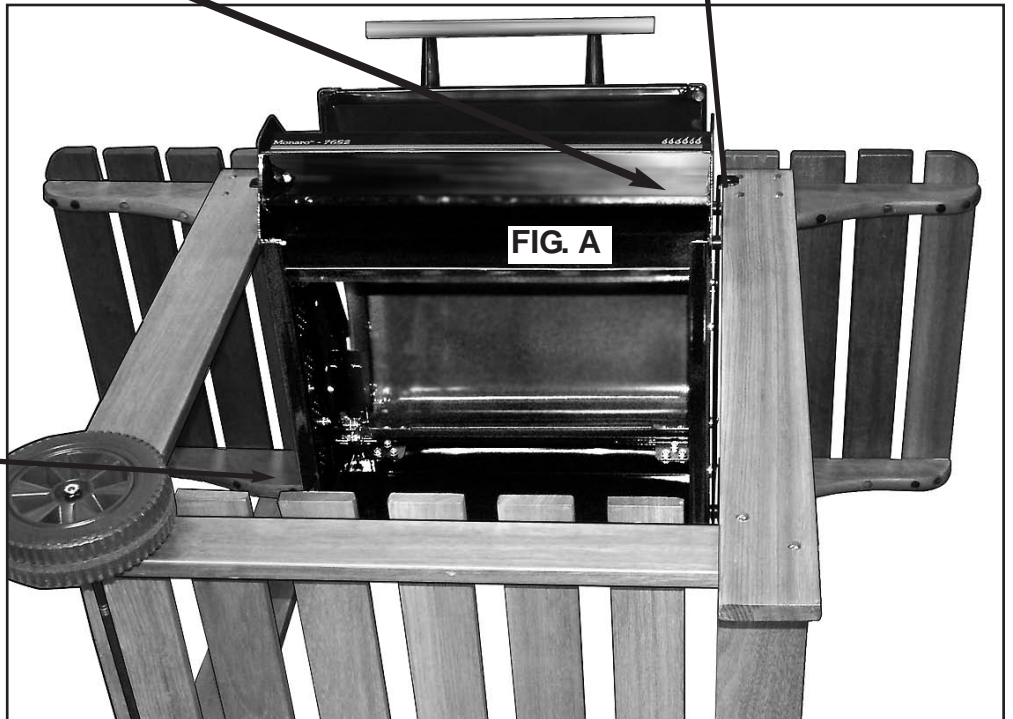
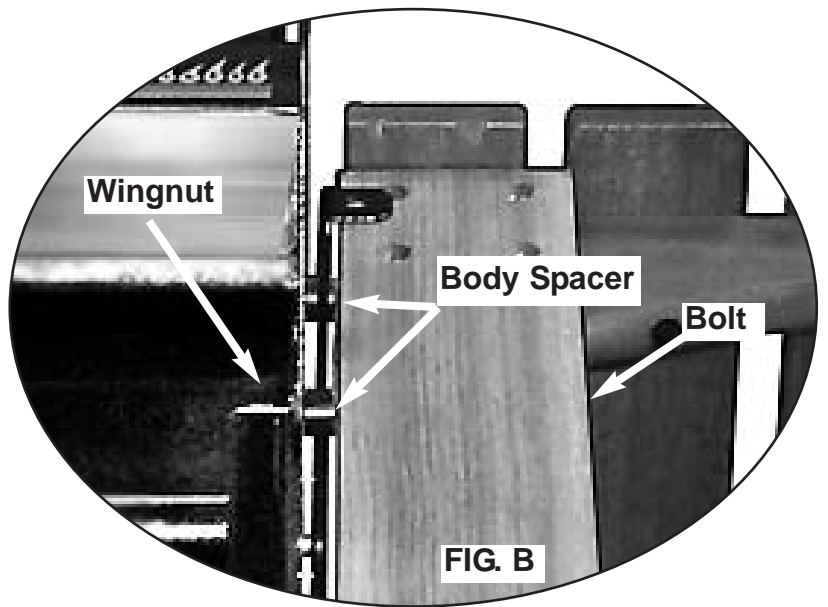

STEP 7- Install Drip Pan, Charcoal Grate & Cooking Grid



(ITEM 22) Drip Pan



(ITEM 23) Charcoal Grate



(ITEM 24) Cooking Grid

- Slide Drip Pan back into Grill Body. Make sure the Drip Pan is pushed all the way in.
- Hang Charcoal Grate inside Grill Body by hooking the handles inside the two (2) elongated slots on each side of the Grill Body.
- Lay the Cooking Grids on the front and rear Body shoulders above the Charcoal Holder.

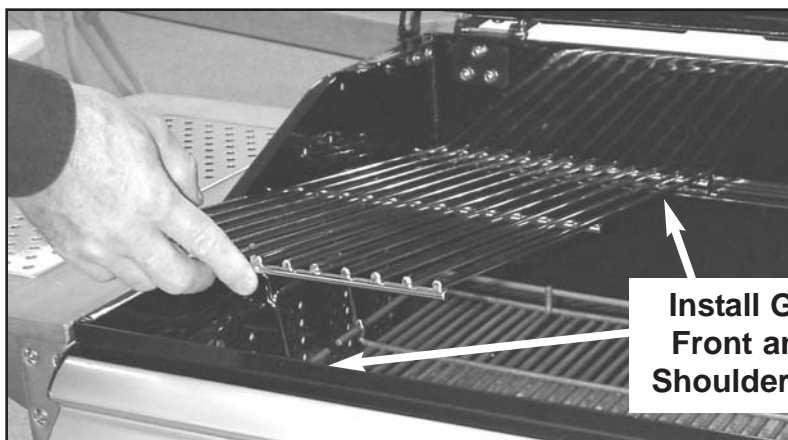
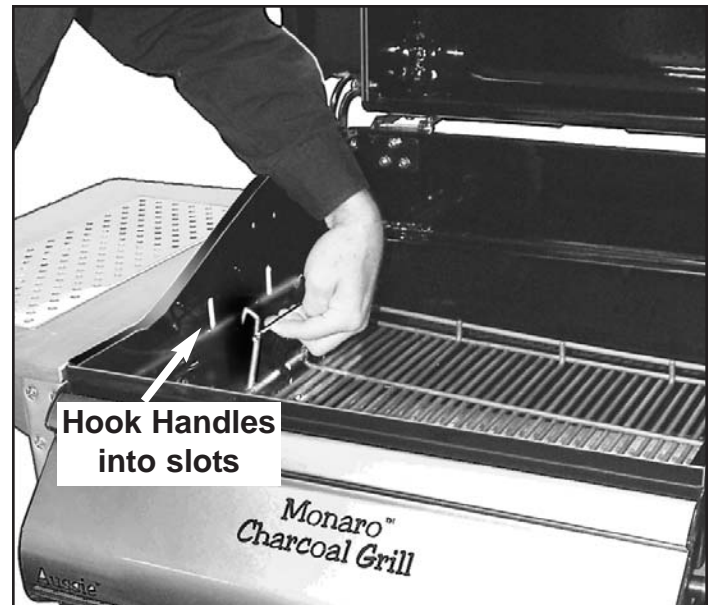

OPERATING AND MAINTAINING YOUR CHARCOAL GRILL

BEFORE USING YOUR CHARCOAL GRILL

USING CHARCOAL

WARNING

To reduce the risk of serious bodily injury or death:

- Be careful when burning charcoal to avoid getting burned from flame, heat or hot coals.
- Burning charcoal consumes oxygen and produces toxic gases, including carbon monoxide that can kill.
- Be aware of the wind blown sparks.
- Always have an ABC fire extinguisher, baking soda, a bucket of sand or a garden hose ready in case of an uncontrolled fire.

Use a high quality hardwood charcoal to make sure you get a good fire. Charcoal briquettes made from maple, oak, birch or elm woods will burn clean with very little smoke and without unpleasant odors.

SELECTING A LOCATION

WARNING

To reduce the risk of serious bodily injury or death:

- Locate your charcoal in an open area away from buildings, dry leaves, or brush and at least 10 feet away from your house or building.
- Always make sure the grill is on a level, stable surface and not tilted toward the front or back.
- Do not use the grill in a garage, breezeway, carport, porch, high traffic area, on or under any surface that can catch fire.
- Do not use a charcoal grill indoors, on recreational vehicles, or boats.
- Do not use a charcoal grill as a space heater.

OPERATING THE CHARCOAL GRILL

WARNING

To reduce the risk of serious bodily injury or death:

- Never use a barbecue grill unless all parts of the unit are firmly in place and the grill is stable.
- Never use gasoline, kerosene, alcohol or other volatile fluids as a starter. They can explode.
- Do not use aerosols or store flammable liquids or materials near this charcoal grill. Cap Lighter fluid immediately and place a safe distance from the grill.
- Instant light briquettes already have the starter blended in, do not use lighter fluid, an electric starter, solid, or metal chimney starters.
- Do not add more instant light briquettes once the fire has been lit. To avoid flame-ups, unpleasant fumes and odors, add regular charcoal briquettes if needed.

- Once the barbecue grill has been lit, do not touch the charcoal briquettes/wood chunks to see if they are hot.
- Never add lighter fluid to already hot or warm coals.
- Do not close Hood on flaming charcoal. If closed and re-opened, the flames could leap out and burn.
- Do not wear loose clothing (example: hanging shirt tails, clothing with frills, etc.) around a charcoal grill while in use or hot.
- Do not lean your body over the charcoal grill when lighting it, while it hot or is in use.
- Do not touch hot surfaces. Use heat resistant gloves, long-handled tongs, or cooking mitts at all times since the grill will become very hot.
- Open the hood carefully when cooking to avoid burn from the hot air and steam trapped inside.
- Do not move a charcoal grill when in use or hot.
- Do not douse or spray the grill or cooking surfaces with water when hot. Burns from grease or the water splatters could occur.
- Do not allow children to operate or play near a charcoal grill. Keep animals and bystanders out of the grill area. Do not leave grill unattended.
- Allow grill to cool before handling parts or cleaning.
- To avoid a fire, allow coals to burn out completely and let the ashes cool for 48 hours before disposing of them.
- Do not attempt to extinguish a grease fire with water or other liquids. Have a BC fire extinguisher nearby.
- If your Charcoal grill catches on fire:
 - Evacuate everyone from the area.
 - If you can, close the Hood.
 - If the fire is a grease fire, and you can safely extinguish, use baking soda, a BC fire extinguisher or a bucket of sand.
 - If the fire is any other type and cannot be extinguished with water, leave it alone and call the fire department.
 - If there is any type of fire that threatens either personal safety or endangers property, call the fire department.

STARTING A FIRE

WARNING

To reduce the risk of serious bodily injury or death:

- Make certain you leave the Hood all the way open until the flames have died down.
- Should electrically operated starters be used, be sure they are properly grounded according to local codes. Electrical cords should be placed away from walkways or traffic areas.

STEP 1. Open the Hood and the Slide Vents.

STEP 2. Remove the Cooking grids. Make sure the Drip Pan is pushed all the way in.

STEP 3. Place about five pounds of charcoal (72-75 briquettes) on the Charcoal Grate. Make a pyramid shaped stack near the front of the Charcoal Grate. (See Illustration Starting A Fire.)

STEP 4a. For regular charcoal or wood, apply the lighter fluid, following the container instructions. Let the lighter fluid soak in for approximately one minute. You may use an electric fire starter; just leave off the lighter fluid and follow manufacturer's instructions on the container).

STEP 4b. For instant light briquettes, do not use lighter fluid, an electric fire starter solid, or chimney starters. The starter accelerant is blended into the briquettes and will cause flame-ups, unpleasant fumes and odors.

STEP 5. Carefully light the charcoal and let it burn for about 30 minutes or until it is covered with a light gray ash. Do not close the hood.

STEP 6. Using long-handled tongs and barbecue mitts, spread the charcoal out inside the Charcoal Holder. Leave about one-half inch of space between each piece of charcoal. This will help to avoid flare-up from the meat drippings and more even heat for grilling. (See Illustration For Grilling.)

STEP 7. You may begin cooking by placing the grids in the grill and food on the grids. Then close the hood for smoke cooking.



GRILL COOKING

WARNING

To reduce the risk of serious bodily injury or death:

- Avoid burns from the hot air and steam trapped inside, by opening the hood carefully when grill roasting.
- Avoid burns by using barbecue mitts and long handled tongs when placing wood chips or chunks on the charcoal and for handling the Cooking Grids when they are hot.
- If flare-ups occur, close the vents for at least one minute to stop flare-up. Do not use water.
- Do not cover more than half (50%) the cooking area if using giddle plates. Full coverage of cooking area will cause overheating below the plates and could damage the grill or cause a possible hazard.

1) Cooking on the Grids is heated by the burning charcoal underneath. The natural food juices from the juices fall onto the hot Charcoal and vaporize. Rising smoke bastes the food, giving it that unique barbecued flavor.

Leave the Slide Vents open for the most heat. Close the vents partially to lower the heat. It takes a few minutes for the charcoal to react to the vent adjustment.

Leave the hood open for "Texas Style" open air barbecuing. Close the hood for "Smoker" cooking or when you want to hold in all the heat.

2) Smoking: For true smoke flavor, use chips or chunks of wood from nut or fruit trees such as hickory, walnut, cherry or apple. Soak the chips in water overnight so they will not burn when you put them on the charcoal.

After you get the fire started, put the soaked chips on top of the hot charcoal. Place the meat on the grid or rotisserie spit and close the hood.

Continue adding chips while the meat cooks to maintain the appropriate amount of smoke. Smoking is a very slow process. Therefore, allow plenty of cooking time.



END OF COOKING SESSION

WARNING

To reduce the risk of serious injury from burns or fire:

- Wait until hot ashes or charcoal is completely extinguished before disposal in a safe place.
- Allow the grill to cool before cleaning, moving or putting on a grill cover.
- Empty and clean the Drip Pan after each cooking session so excessive grease does not accumulate. Never light the charcoal grill without the Drip Pan in place.

- 1) After each cooking session, close the hood.
- 2) Close the Slide Vents and allow the charcoal to die down.
- 3) Wait until the grill is cool.
- 4) Regularly clean your charcoal grill between uses and after extended storage periods. To maintain the condition and extend the life of your grill, we strongly recommend that the unit be covered when stored outside for any length of time, especially during the winter months.

CARE AND MAINTENANCE

CAUTION

To reduce the risk of a cut injury:

- Be careful or wear protective gloves when cleaning grill parts that have sharp edges.

CLEANING THE GRILL

- 1) **Charcoal Grate**-Remove and shake expended ashes into a safe receptacle or area. If any unburned charcoal, just leave it until next time. (Optional) Scrape any residue from the grate. Wash with warm soapy water if you wish, or just spray with garden hose.
- 2) **Drip Pan**-Remove and clean out excess grease and drippings. Wash with soap and water or mild abrasive cleanser.

- 3) **Cooking Grids**-Clean the residue off with a baking soda and water solution. Use a non-abrasive scouring powder. for stubborn stains. Some char may remain; ok to leave it.
- 4) **Grill Body**-Remove excess grease and/or fat with a soft plastic or wooden scraper. Do not use steel wool or other abrasive cleansers that can scratch the porcelain coated surfaces. It is not necessary to remove all the grease from the body. Wipe it down with paper towels or soft damp cloth. For further cleaning, use hot soapy water and a cloth, or nylon-bristled brush only.
- 5) **Side Tables and Wood parts**-Wipe off with damp cloth.

STORAGE

WARNING

To reduce the risk of serious bodily injury or death:

- Do not store a charcoal grill while it is hot.
- Store your charcoal grill in a cool dry place.
- Do not store charcoal and lighter fluid indoors. Store it outdoors out of the reach of children.
- To avoid an fire or explosion, do not store charcoal or lighter fluid near a heat source.
- Do not store additional charcoal and lighter fluid under or near the charcoal grill while it is hot.
- Always cap the lighter fluid when not in use.

- 1) Clean your grill before storing.
- 2) Remove the Cooking Grid. Rub with a coat of light cooking oil and wrap with aluminum foil. Store wrapped Cooking Grid back into the grill.
- 3) You may also wrap the Charcoal Grate in aluminum foil or just leave it alone.
- 4) Store Charcoal and lighter fluid separate from the grill.
- 5) Place a grill cover over the grill and store it outdoors if possible. It may be stored indoors only if the charcoal and lighter fluid are not stored with it.
- 6) Before next use, remove aluminum foil from Cooking Grids and Charcoal Grate and reinstall in grill.
- 7) Periodically check and tighten all nuts, bolts, and screws.

Aussie®