



Assembly and Instruction Manual

Charcoal Grill Model 9945-700



IMPORTANT

Read this manual carefully before assembling, using or servicing this unit. Keep this manual for future reference. If you have questions about assembly, operation, servicing or repair, please call Coleman at 1-800-835-3278 or TDD: 316-832-8707. In Canada call 1-800-387-6161.

For Outdoor use only

U. S. patents pending

Contents

Introduction.....	2
General Safety Information.....	2
Assembly.....	2 - 4
Instructions for Use	4 - 5
Notes	6
Replacement Parts	7
Warranty	8

Introduction

Follow these instructions for assembly and read carefully, particularly the safety statements. The safety alert symbol, ⚠, is a universally recognized symbol used to identify safety information about hazards that can result in personal injury. When this symbol is used you should pay very close attention to what is written. Review these instructions before beginning assembly or using your grill.

General Safety Information

⚠ DANGER

FOLLOW INSTRUCTIONS AND WARNINGS TO AVOID FIRE, SERIOUS INJURY OR DEATH.

- Outdoor use only. Never use in enclosed area. Use in unventilated areas can cause death.
- Keep away from all combustible materials including gasoline and other flammable liquids and vapors.
- Read & follow all warnings on charcoal package.
- Use on a level, noncombustible surface only. Keep away from house, garage, balconies, or eave overhangs.
- Keep out of the reach of children.
- Exercise the same care you would with an open fire.
- Never leave unit unattended when hot or in use.
- Completely extinguish fire before leaving.
- Use gloves when handling or moving. Ashes can remain warm for a long time after extinguishing.
- Dispose of cold ashes properly.
- Do not modify in any way or use with parts not expressly approved by Coleman.

Contact local authorities regarding possible burn restrictions before using product.

⚠ WARNING



• BURN HAZARD

- Unit is hot when being used. Use care when servicing.
- Keep out of reach of children.

⚠ WARNING

Combustion by-products produced when using this product contain chemicals known to the State of California to cause cancer, birth defects, or other reproductive harm.

Assembly

For use only with charcoal.

LEFT LEG ASSEMBLY

- Align Left Leg with Bracket and attach as shown.

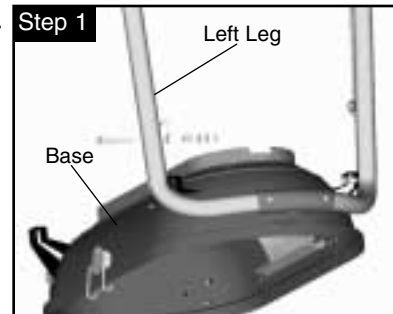

See Blister Pack for hardware identification.

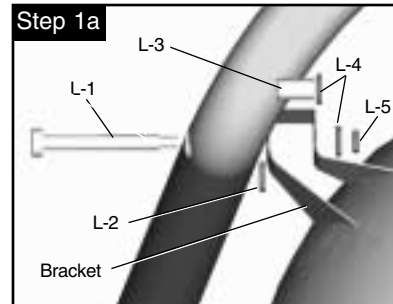

- Hand tighten Nut. (Step 2)
- Repeat for other side.
- Tighten bolts and nuts. (Step 3)

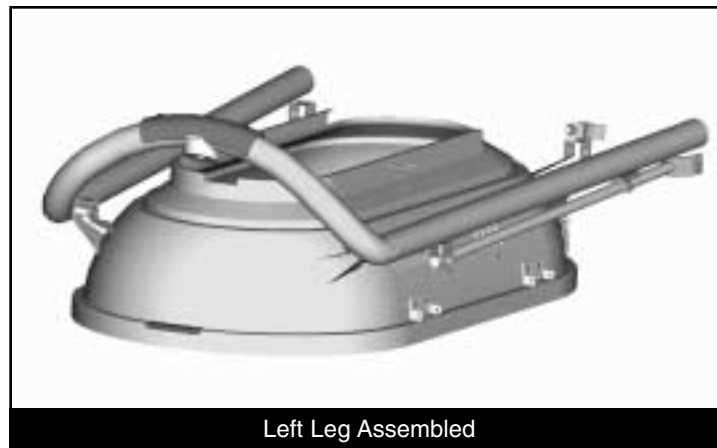
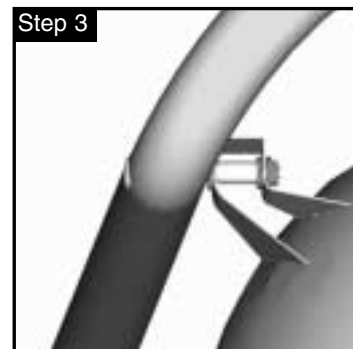
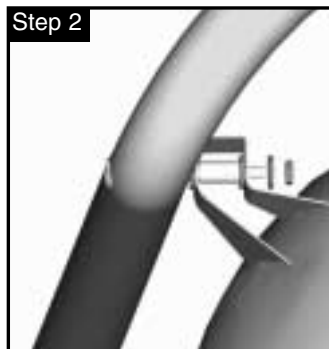

NOTE: After Left Leg is assembled the Leg should have slight resistance in movement.

Assembly (cont)

RIGHT LEG ASSEMBLY

- Tap one L-7 onto Wheel Axle. (Step 4)

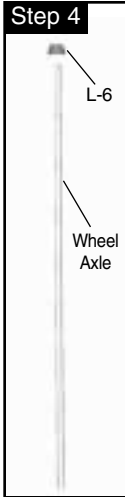

See Blister Pack for hardware identification.

- Install Axle and hardware as shown. (Step 5)
See Blister Pack for hardware identification.

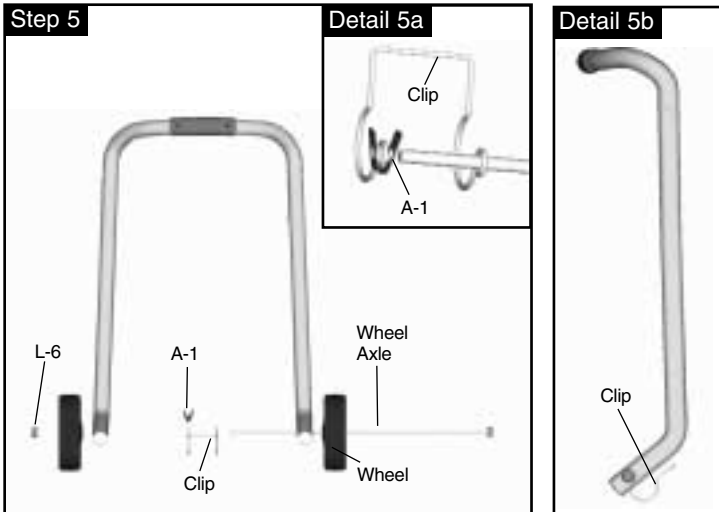

NOTE: Clip orientation is important. See Detail 5b.

- Align Right Leg with Bracket and repeat Steps 1, 2, and 3.

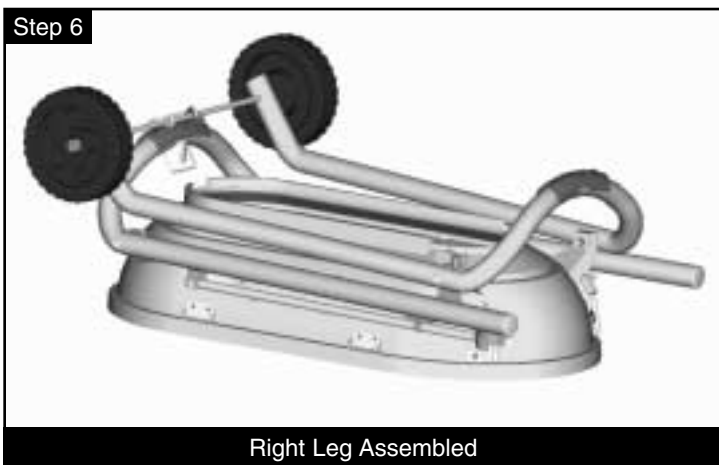

NOTE: After Right Leg is assembled the Leg should have slight resistance in movement.

HANDLE ASSEMBLY

- Place Lid upside down on a nonabrasive surface to protect the finish and attach as shown. (Step 8)

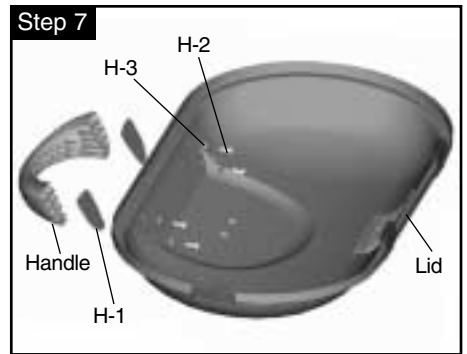

See Blister Pack for hardware identification.

Be careful not to overtighten.

LID ASSEMBLY

- Place Lid on Base.
- Align holes in Top Hinges with holes in Bottom Hinges then secure with Bolt Hardware as shown. (Step 8)

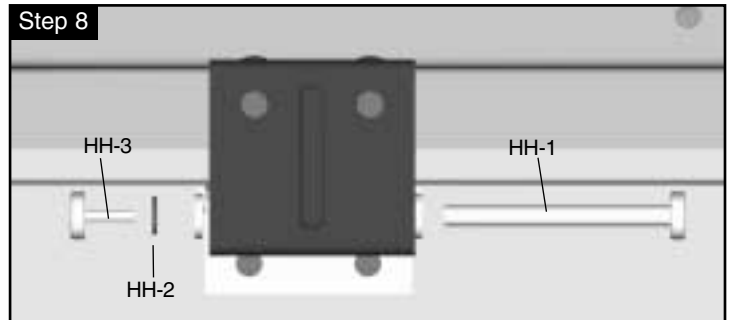

See Blister Pack for hardware identification.

CHARCOAL GRATE ASSEMBLY

- Place Charcoal Grate in Base and rotate allowing Lever to slide through opening in Base as shown.

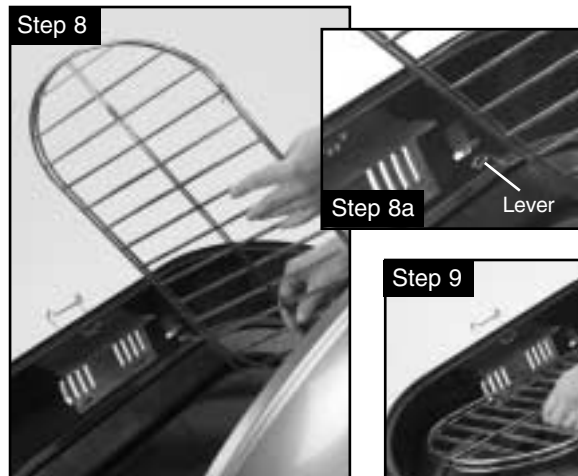

Assembly (cont)

- Align Grate Pins with holes in Base as shown. (Step 10)

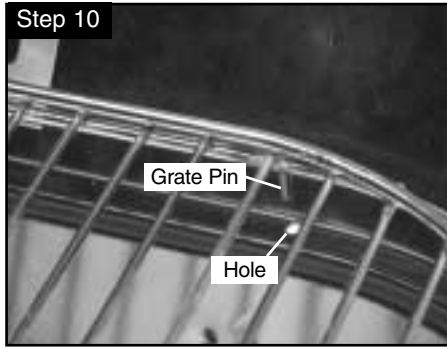

Instructions For Use

GRILL SET-UP

IMPORTANT:

- Side Shelf must be attached before grill set-up.

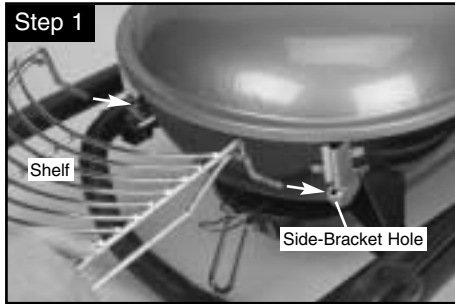

- Push Clip down to release Legs from stored position.



- Extend Wheeled Legs and lock in place.



Instructions For Use (cont)

- Lift into upright position. (Step 4).

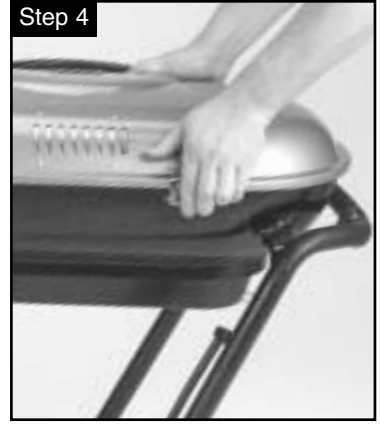

- Do not lift with hand on either end of grill. This could pinch fingers.

- Pull front Legs back to upright position. (Step 4a)



Step 5



Step 5a

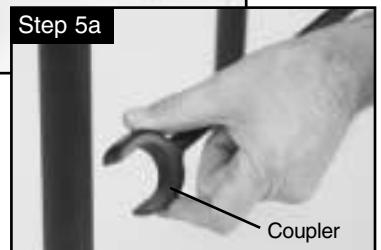

- Extend Leg Brace to secure Legs in upright position. (Step 5)

NOTE: Adjust Coupler on end of Leg Brace to ensure Legs are stable.

Instructions For Use (cont)

SIDE SHELF REMOVAL

- Pull back tab to release shelf and lift to remove.



CHARCOAL ASH COLLECTION SYSTEM

IMPORTANT:

Be sure Ash Pan Lid is off before lighting charcoal and throughout cooking process.



- When finished cooking, press Charcoal Grate Lever down and slide to the right.
- If all charcoal does not fall through grate, repeat step as necessary.



- Slide lid through Ash Pan channels over used coals and ashes to seal container.

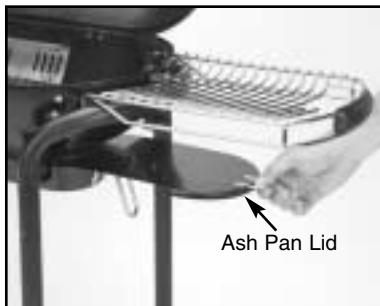

CHARCOAL ASH COLLECTION SYSTEM (cont)

- Remove Ash Collection System as shown.

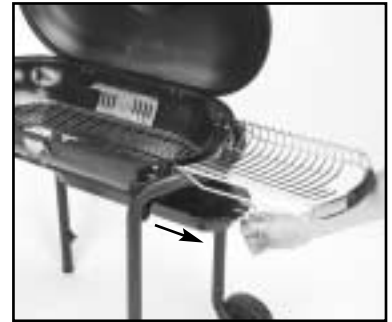

- Use handle to carry Ash Pan. **CAUTION:** It is advisable to wear a glove to prevent injury or burns.
- Properly discard ashes.



Grill Transport

- Use handle on Side Shelf to transport grill. Make sure Clip is latched to lock legs. **CAUTION:** Do not attempt to move grill with lighted charcoal in unit.

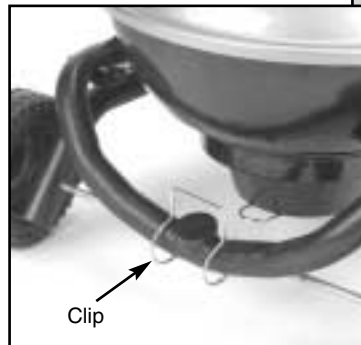

Accessories



Carry Bag
9945-100



Grill Cover
9945-102



Griddle
9945-3171

Visit us at www.coleman.com
Or
Call us at 1-800-835-3278

Notes

Replacement Parts

Parts List

No.	Qty.	Description	Part No.
1	1	Lid Assembly	9945-1061
2	1	Handle	9945-1281
3	1	Cooking Grate Assembly	9945-3161
4	1	Charcoal Grate Assembly	9945-3151
5	1	Base Assembly	9945-2331
6	1	Left Leg Assembly	9945-2341
7	1	Ash Pan Assembly	9945-2321
8	1	Ash Pan Lid Assembly	9945-2311
9	1	Side Shelf Assembly	9945-2361
10	1	Right Leg Assembly	9945-2351
11	2	Wheel	9945-2201
12	1	Axle	9945-1121
13	1	Clip	9945-1751
14	1	Blister Pack (Hardware) <i>(for items not identified)</i>	9945-1901

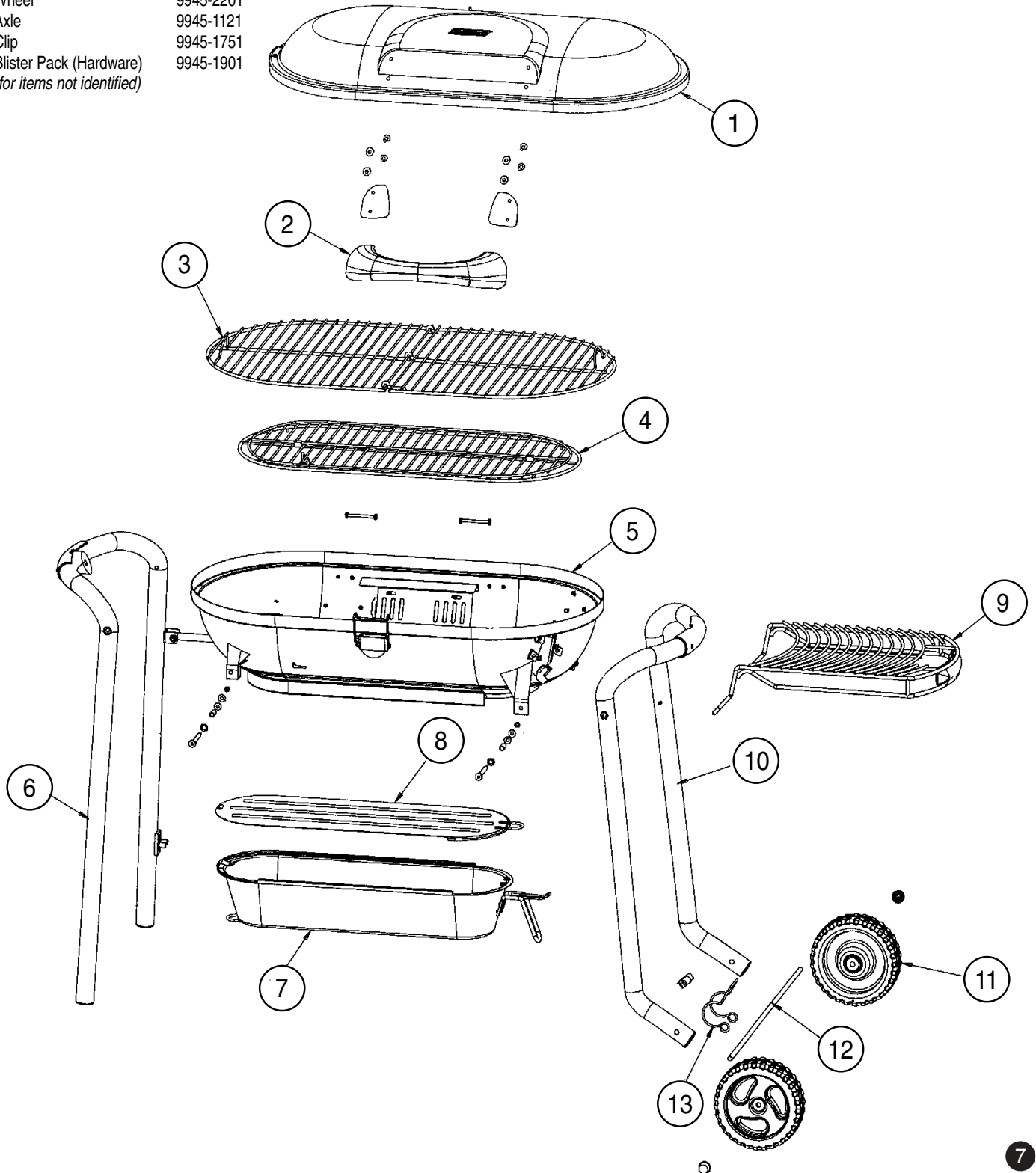

5-Year Limited Warranty

The Coleman Company, Inc. ("Coleman") warrants that for a period of five years from the date of purchase, this product will be free from defects in material and workmanship. Coleman, at its option, will repair or replace this product or any component of the product found to be defective during the warranty period. Replacement will be made with a new or remanufactured product or component. If the product is no longer available, replacement may be made with a similar product of equal or greater value. This is your exclusive warranty.

This warranty is valid for the original retail purchaser from the date of initial retail purchase and is not transferable. Keep the original sales receipt. Proof of purchase is required to obtain warranty performance. Coleman dealers, service centers, or retail stores selling Coleman products do not have the right to alter, modify or any way change the terms and conditions of this warranty.

This warranty does not cover normal wear of parts or damage resulting from any of the following: negligent use or misuse of the product, use contrary to the operating instructions, disassembly, repair or alteration by anyone other than Coleman or an authorized service center. Further, the warranty does not cover Acts of God, such as fire, flood, hurricanes and tornadoes.

Coleman shall not be liable for any incidental or consequential damages caused by the breach of any express or implied warranty. Except to the extent prohibited by applicable law, any implied warranty of merchantability or fitness for a particular purpose is limited in duration to the duration of the above warranty. Some states, provinces or jurisdictions do not allow the exclusion or limitation of incidental or consequential damages or limitations on how long an implied warranty lasts, so the above limitations or exclusion may not apply to you. This warranty gives you specific legal rights, and you may also have other rights that vary from state to state or province to province.

How to Obtain Warranty Service

Take the product to an authorized Coleman service center. You can find the nearest authorized Coleman service center by calling 1-800-835-3278 or TDD 316-832-8707. If a service center is not conveniently located, attach a tag to the product that includes your name, address, daytime telephone number and description of the problem. Include a copy of the original sales receipt. Carefully package the product and send either by UPS or Parcel Post with shipping and insurance prepaid to:

For products purchased in the United States:

The Coleman Company, Inc.
3600 North Hydraulic
Wichita, KS 67219

For products purchased in Canada:

The Canadian Coleman Company, Ltd.
5975 Falbourne Street
Mississauga, Ontario, Canada L5R 3V8



DO NOT RETURN THIS PRODUCT TO THE PLACE OF PURCHASE.

If you have any questions regarding this warranty please call 1-800-835-3278 or TDD 316-832-8707.

Made in China.

© 2002 The Coleman Company, Inc. All rights reserved.

Coleman® is a registered trademark of The Coleman Company, Inc.



The Coleman Co., Inc.
3600 N. Hydraulic
Wichita, KS 67219 U.S.A.
1-800-835-3278
TDD: 316-832-8707
www.coleman.com