

# **HOOVER®**

## **Breathe Easy™**

---

### **Owner's Manual**

**ENGLISH** → pp.1-13

ESPAÑOL → pág. 14-21

FRANÇAIS → p. 23-29

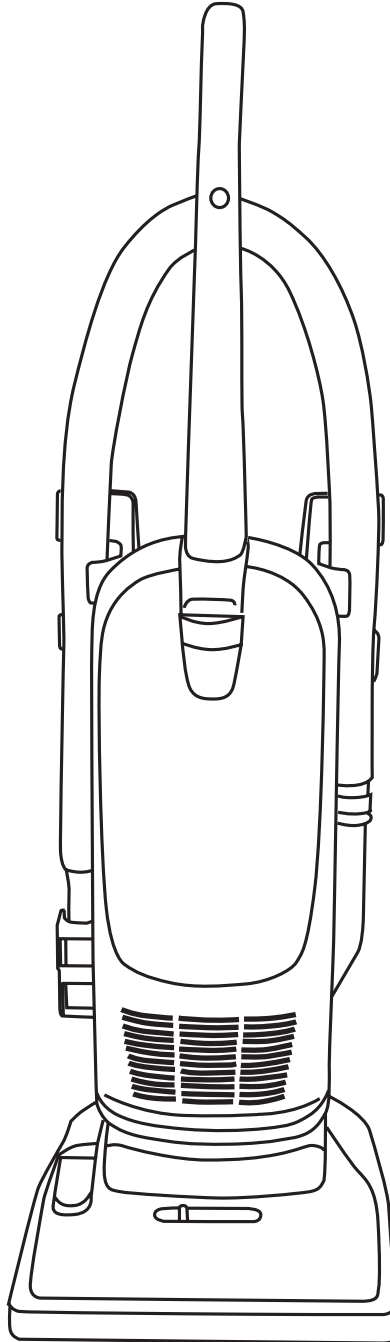

**Read this manual before  
operating the cleaner**



# Fill in and retain

The model and serial number are located on the bottom of the cleaner.

For your personal records, please enter the COMPLETE model and serial number in the spaces provided and retain this information.

Your cleaner is model \_\_\_\_\_

and has serial number \_\_\_\_\_

It is suggested that you attach your sales receipt to this owner's manual. Verification of date of purchase may be required for warranty service of your HOOVER product.

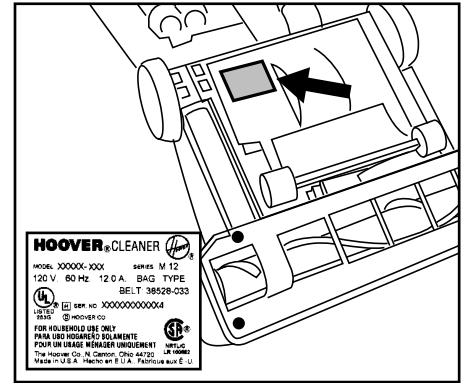

# Save!

## Index

Assembling Cleaner .....3-6  
 How To Use  
     Cleaner Description .....6  
     Cleaning Tools .....8  
     Upright Cleaner .....7-8  
 If You Have a Problem .....12  
     Clearing Blockages .....13  
 Important Safeguards .....2  
 Maintenance  
     Authorized Service.....12  
     Lubrication .....11  
     Replacing Belt .....10-11  
     Replacing Brush Roll .....11  
     Replacing Headlight.....10  
     Replacing Filter Bag .....9  
     Replacing Final Filter .....9-10  
 Warranty .....12

# Important Safeguards

When using an electrical appliance, always follow basic precautions, including the following:

**READ ALL INSTRUCTIONS BEFORE USING THIS APPLIANCE**

## Warning:

To reduce the risk of fire, electric shock, or injury:

- Do not use outdoors or on wet surfaces.
- Close supervision is necessary when any appliance is used by or near children. Do not allow vacuum cleaner to be used as a toy or to run unattended at any time.
- Keep hair, loose clothing, fingers, feet and all parts of body away from openings, rotating agitator and other moving parts. Do not operate cleaner in bare feet or when wearing open toe shoes or sandals.
- Do not pick up anything that is burning or smoking, such as cigarettes, matches, or hot ashes.
- Do not use to pick up flammable or combustible materials such as gasoline or fine wood sandings or use in areas where they may be present.
- Avoid picking up hard, sharp objects with the cleaner. They may damage the cleaner and the bag.
- Always turn off this appliance before connecting or disconnecting hose.
- Do not use without dust bag or filters in place. Change bag frequently when picking up very fine materials such as powder.
- Use extra care when cleaning on stairs.
- Do not put any object into openings. Do not use with any opening blocked; keep free of dust, lint, hair, or anything that may reduce air flow.
- Do not pull or carry by cord, use cord as a handle, close door on cord or pull cord around sharp edges or corners. Do not run appliance over cord. Keep cord away from heated surfaces.
- Always disconnect cord from electrical outlet before servicing the cleaner.
- Unplug cleaner when not in use. Turn off all controls before unplugging.
- Do not unplug by pulling on cord. To unplug, grasp the plug, not the cord. Never handle plug or appliance with wet hands.
- The use of an extension cord is not recommended.
- Do not use with damaged cord or plug. If appliance is not working as it should, has been dropped, damaged, left outdoors, or dropped into water, take it to a Hoover Factory Service Center or Authorized Hoover Warranty Service Dealer (Depot).
- Use vacuum cleaner only for its intended use as described in the instructions. Use only attachments recommended by The Hoover Company; others may cause hazards.



© 2003 The Hoover Company

www.hoover.com

# Save these instructions!

# 1. Assembling cleaner

**It is extremely important to read and follow all the instruction steps in order.**

The assembled cleaner will look like this drawing.

If you need assistance with any step of the assembly or operation:

Visit us on-line at [www.hoover.com](http://www.hoover.com) to find the service outlet nearest you (click on the "Service" button) OR call

**1-800-944-9200** for an automated referral of authorized service outlet locations (U.S. only) OR call

1-330-499-9499 to speak with a representative in our Consumer Response Center.

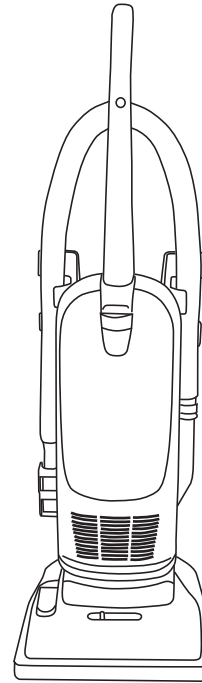

## Carton contents

Remove all parts from carton and identify each item shown.

Note that some of the items are shipped together in the sealed bag with the owner's manual.

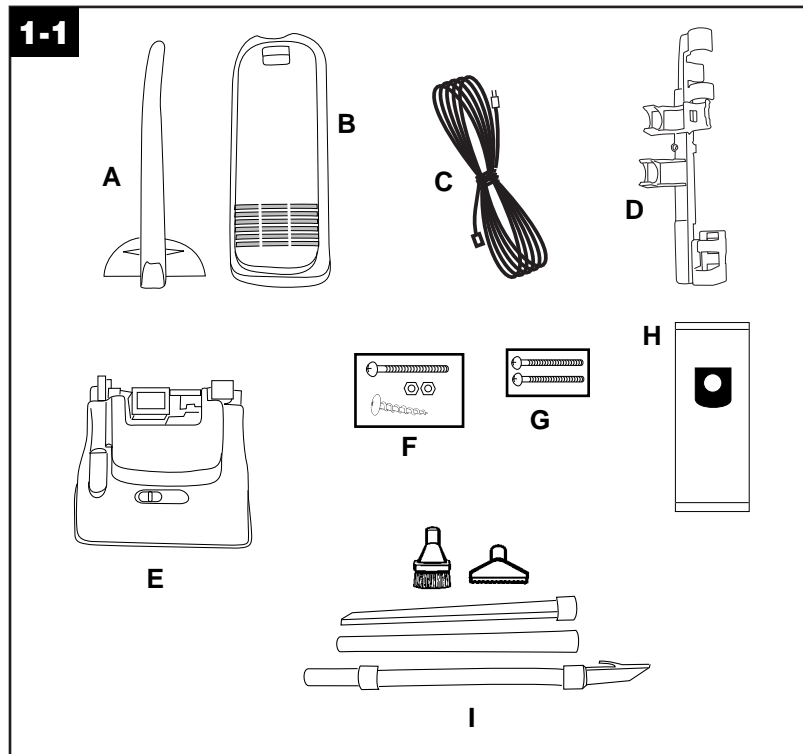

**A. Upper handle**

**B. Bag compartment assembly**

**C. Cord**

**D. Hose and tool holder**

**E. Cleaner base**

**F. Handle bolt and nut and hose holder screw packet (One extra nut included)**

**G. Upper handle screws (2)**

**H. Paper filter bag**

**I. Hose, cleaning tools, crevice wand (stores inside extension wand) and extension wand**

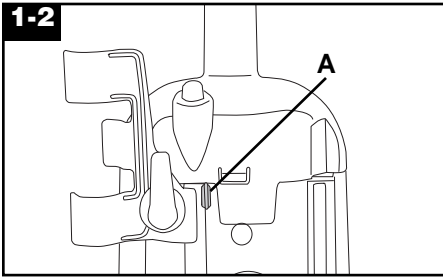

**Note:** The **green or white switch lock (A)** near the ON/OFF switch on the **back** of the bag compartment assembly, helps in **assembling** your cleaner.

Assembly can be continued if the switch lock is missing. However, **do not remove** the switch lock until assembly is completed.

## Step 1 Assemble handle

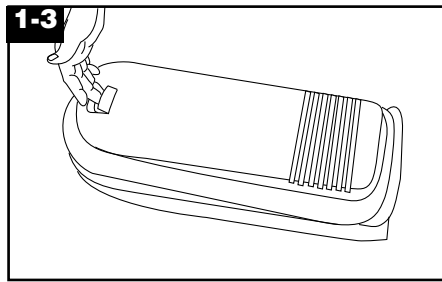

### Removing bag door

Pull bag door latch forward and remove bag door.

Set bag door aside.

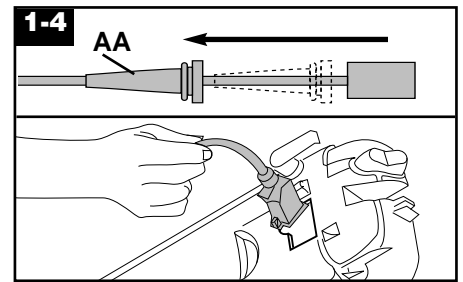

### Attaching cord

**Slide cord protector (AA) away from rectangular end of cord.**

Insert large rectangular end of cord through opening in **back** of bag compartment.

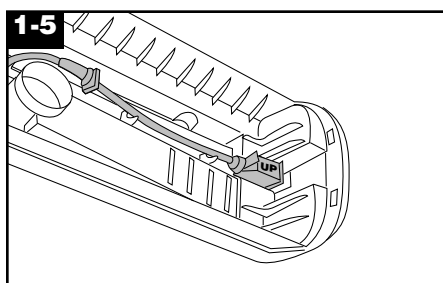

With side marked "UP" visible, insert end into pocket in the bottom of the bag compartment assembly.

**Slide cord protector toward top of bag assembly and slide through opening.**

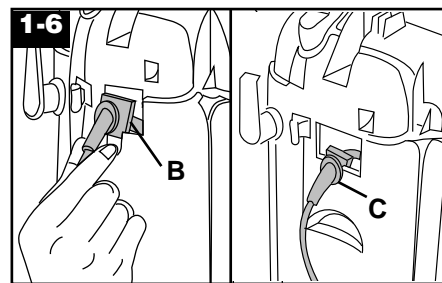

With bag compartment in the vertical position, rotate cord protector (B) on cord so that the arrow is on the side.

Press protector into the slot (C). Protector should be pointing downward when assembly is in the verticle position.

**Pull cord tight.**

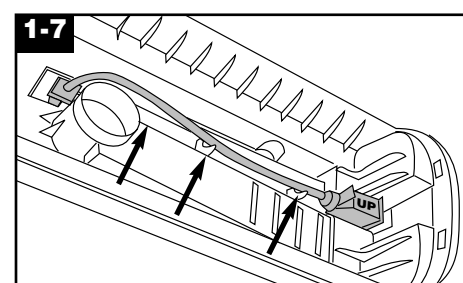

Press cord into place at each of the three slots indicated.

**Do not plug cleaner in until assembly is totally complete.**

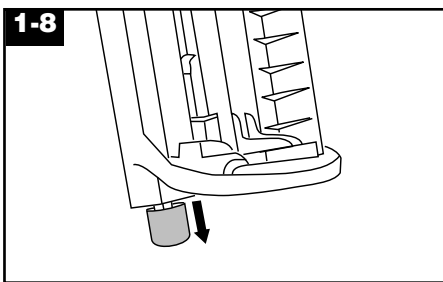

### Attaching bag compartment assembly

Remove cardboard protector from bottom of bag compartment assembly.

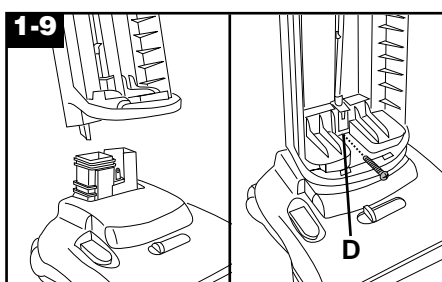

With opening of bag assembly toward the front, place it down onto the extension on cleaner base.

**Rock handle side to side while pushing down firmly. Extra pushing effort may be required.** Make sure handle is pushed down completely.

Push bolt into hole (D) on lower front of assembly.

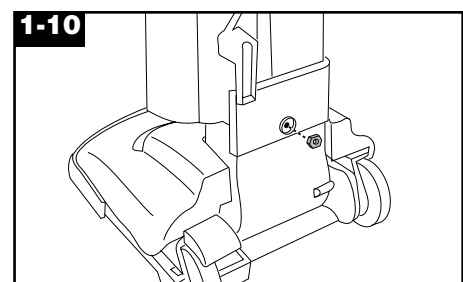

Place **nut** in recessed area at **back of assembly**. Hold nut in place while tightening bolt securely with a screwdriver.

Only one nut is needed on this model. The extra nut is not required but has been provided for your convenience.

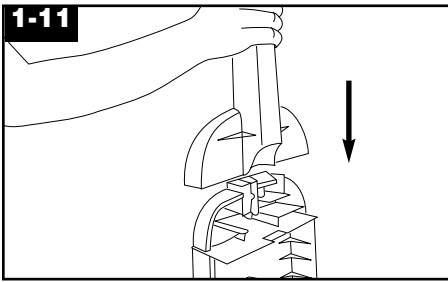

### Attaching upper handle

Slide upper handle onto assembly, as shown, until the handle snaps into position.

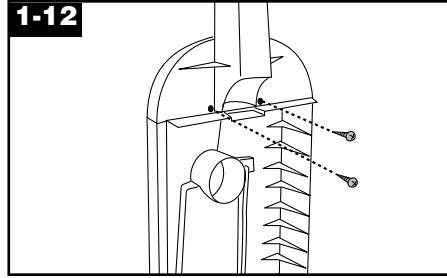

Insert the two screws at the front of the handle to secure it onto the assembly.

Tighten the screws.

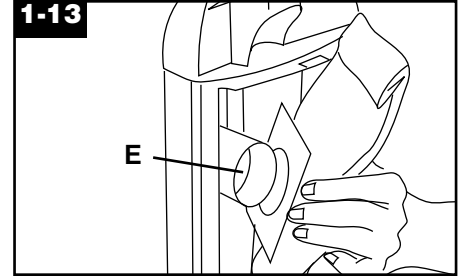

### Attaching filter bag

Align opening in bag with dirt tube (E) inside bag compartment.

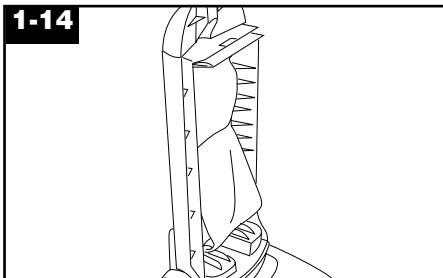

Push bag firmly onto tube. Tuck top and bottom of bag into bag compartment.

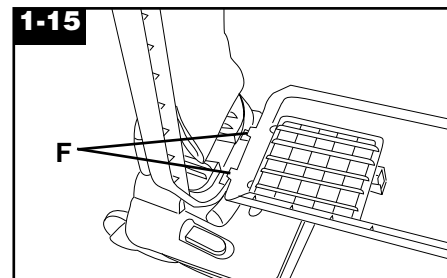

To replace bag door, insert the 2 tabs (F) on bottom of door into the 2 slots on bag compartment.

**Make sure all edges of bag are completely inside the bag compartment.**

Close door.

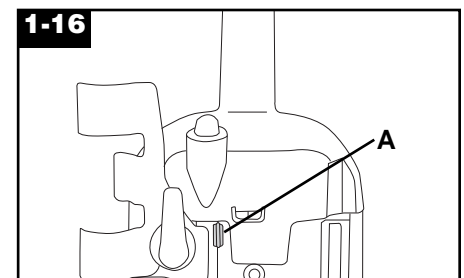

Remove green or white switch lock (A) in back of the cleaner.

## Step 2 Attach tool rack

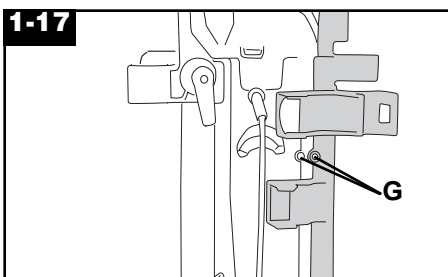

Align screw holes (G) on the tool holder and back of the cleaner. Press holder into back of cleaner until it snaps into position.

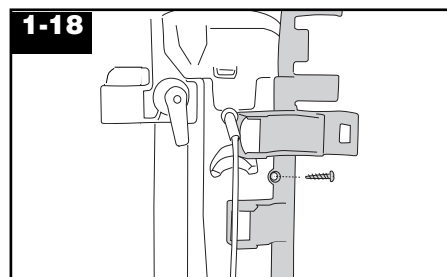

Insert the shorter screw from the handle bolt and nut pack and tighten, using a Phillips screwdriver.

## Step 3 Position hose and tools

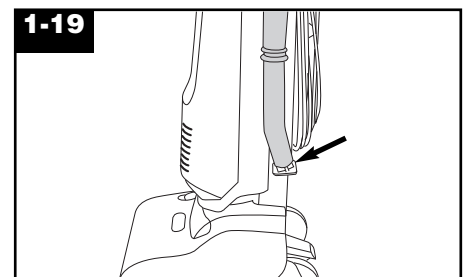

Place round end of hose over round extension on bottom of holder.

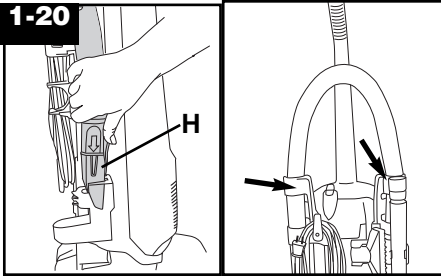

Insert hose connector (H), with latch toward front of cleaner, into opposite side of rack.  
Press hose firmly into rack at upper extensions.

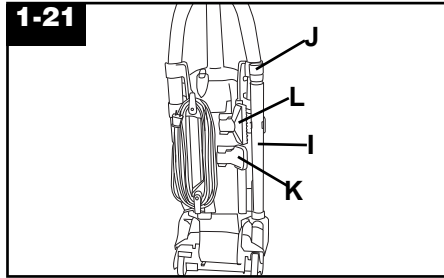

Position extension wand (I). Crevice wand (J) stores inside extension wand.  
Position dusting brush (K) and furniture nozzle (L) as shown.

**CAUTION:** When cleaner is turned on, the agitator will continue to rotate when cleaner handle is in upright position. Avoid tipping cleaner or setting it on furniture, fringed area rugs, or carpeted stairs during tool use.

**Your HOOVER cleaner is now assembled and ready to use!**

Please fill out and return the product registration card included with your cleaner.

## 2. How to use

### Cleaner description

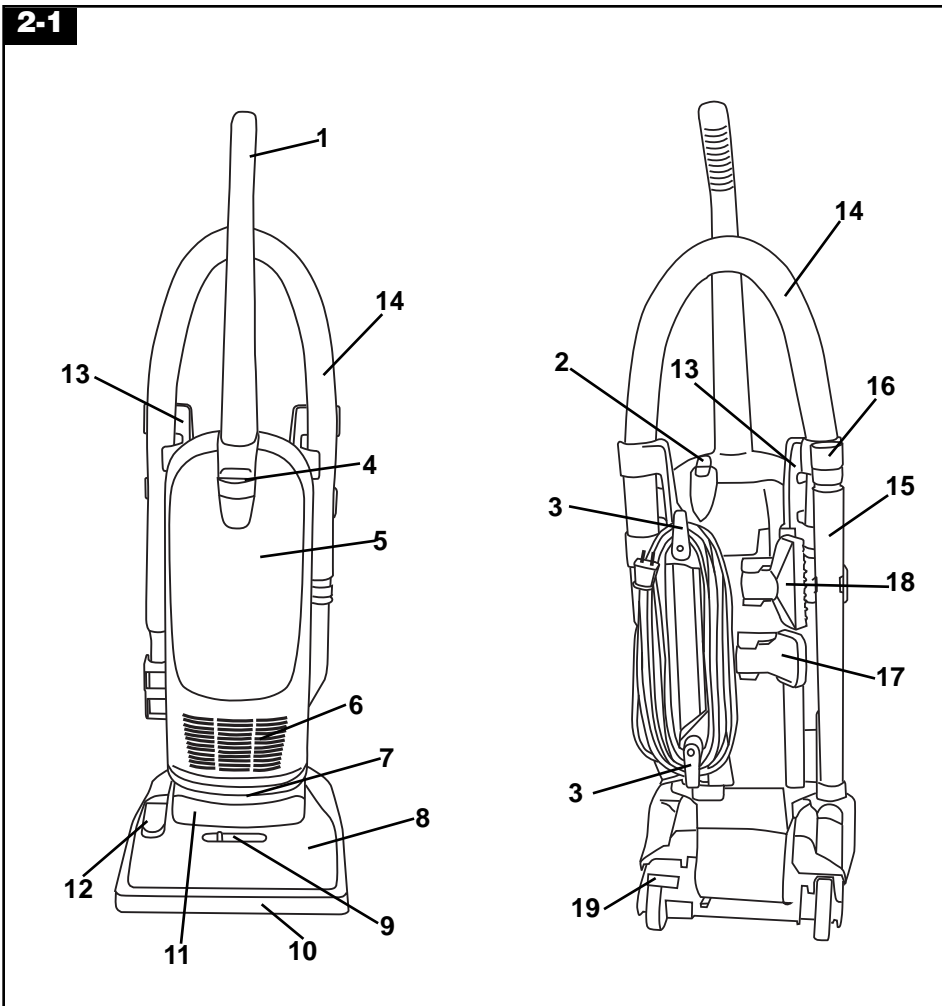

The assembled cleaner will look like the drawing.

1. Handle
2. ON/OFF switch
3. Cord hooks: starting at the bottom hook, wrap cord around hooks for storage. The top hook can be rotated right or left for easy cord release.
4. Bag door latch
5. Bag door
6. Final filter
7. Stair cleaning handle
8. Hood
9. Carpet height control
10. Furniture guard: helps prevent cleaner from marking furniture.
11. Headlight
12. Hose door
13. Hose and tool holder
14. Hose
15. Extension wand
16. Crevice wand: stores inside extension wand.
17. Dusting brush
18. Furniture nozzle
19. Handle release pedal

Operate cleaner only at voltage specified on data plate on bottom of cleaner.  
This cleaner is intended for household use.

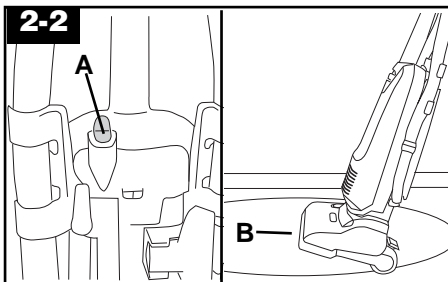

## ON-OFF switch

To turn cleaner ON, depress switch (A) toward front. To turn cleaner OFF, depress switch toward back.

**Note:** To reduce the risk of electric shock, this appliance has a polarized plug (one blade is wider than the other). This plug will fit in a polarized outlet only one way. If the plug does not fit fully in the outlet, reverse the plug. If it still does not fit, contact a qualified electrician to install the proper outlet. Do not change the plug in any way.

To insure that the filter bag is inflated, plug cord into electrical outlet and turn cleaner ON. With handle in upright position, pull back on handle until front of cleaner (B) is lifted off the carpet.

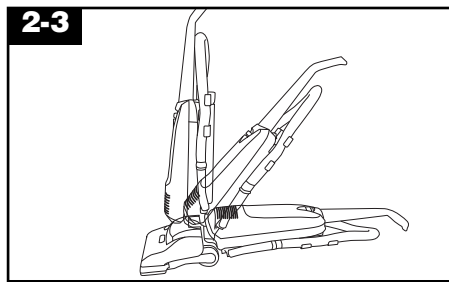

## Handle positions

The handle of your cleaner has three positions; **upright** for storage and when using cleaning tools; **operating** for general operation on carpet and floors; **low** for reaching under low furniture. Step on handle release pedal to lower handle.

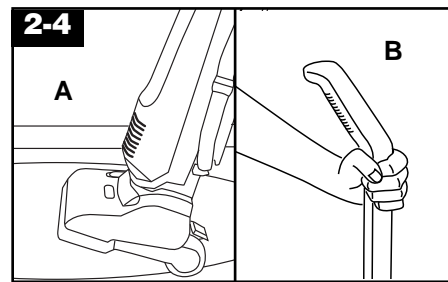

## Transporting cleaner

To move your cleaner from room to room, put handle in upright position, tilt cleaner back on rear wheels, and push forward (A).

The cleaner can also be moved by lifting it as shown in (B)

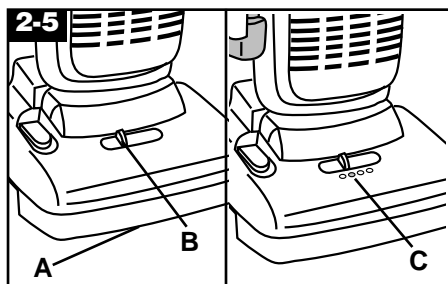

## Carpet height adjustment

When it is necessary to raise and lower the front of the cleaner (A) for various carpet pile heights, slide the carpet height control (B) to the correct setting.

On some models, carpet pile height settings are indicated as shown (C).

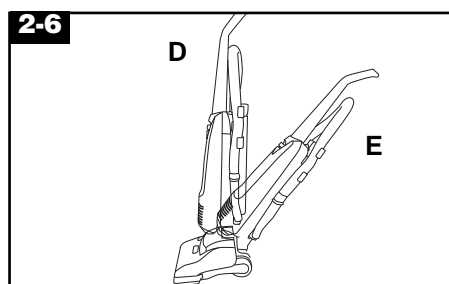

For ease in sliding the control, the handle should be in the upright position (D).

**The front of the cleaner will not move into the adjusted position until the handle is lowered to the operating position (E).**

**For maximum cleaning performance,** the following carpet height settings are recommended.

- **Low Setting 1:** for bare floors
- **Setting 2\*:** for low pile, level loop, kitchen type, and other similar types of carpet
- **Setting 3\*:** for very deep pile carpet

**\*Note:** If the cleaner is difficult to push, slide the control to the next higher setting.

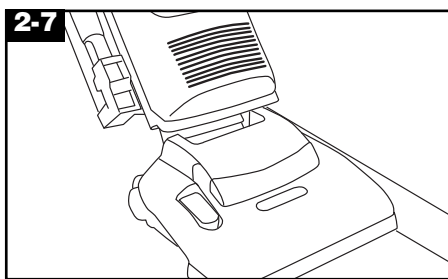

## Edge cleaning

Edge cleaning is provided on both sides of the front of the cleaner to help remove dirt in carpet near baseboards and furniture.

Guide either side of the cleaner parallel to edge of carpet or furniture.

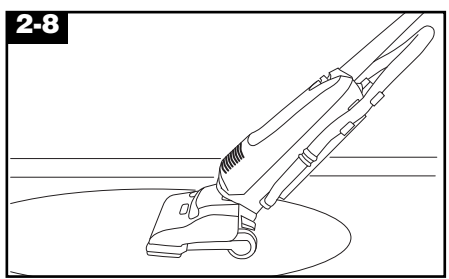

## Cleaning lightweight flexible rugs

Stand on one end of rug and move cleaner toward other end or edge. Before reaching edge, push down on handle. This will lift up the nozzle (front

of cleaner) and will prevent rug from clinging to cleaner.

Continue to lift front of cleaner so that when you have reached the edge, it is completely off the rug. Move cleaner back to start again, lower front of cleaner, and use only forward strokes.

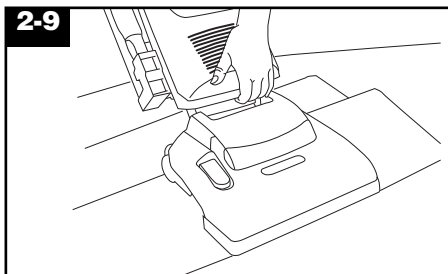

## Stair cleaning

A **stair cleaning handle** has been designed for ease in using your cleaner on stairs.

With handle in operating position, place fingers under edge of stair cleaning handle and guide cleaner with other hand on upper handle.

As an alternative, you may use the hose and furniture nozzle for stair cleaning.

**When using cleaning tools, the agitator will continue to rotate.**

**CAUTION: To avoid personal injury or unnecessary wear to carpet, and to prevent the cleaner from falling, use extra care if cleaner is placed on stairs.**

## Cleaning tools

Tools allow you to clean surfaces above the floor and reach hard to clean areas. If the tool caddy has been removed, reposition it on the cleaner.

**Use tools with the cleaner handle in upright position.**

**CAUTION: Agitator continues to rotate while cleaner handle is in upright position. Avoid tipping cleaner or setting it on furniture, fringed area rugs, or carpeted stairs during tool use.**

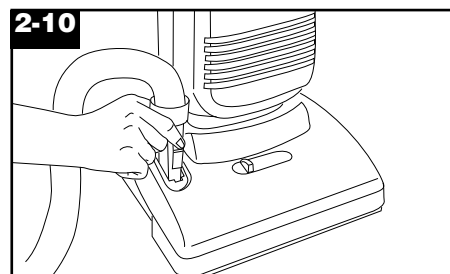

## A. Plug-in hose

**Turn cleaner OFF before plugging-in or removing hose.**

With cleaner handle in **upright position**, open hose door and insert hose connector until it is locked in position. Suction will automatically be diverted to the hose when cleaner is turned ON.

To remove hose, press latch on hose connector and pull up.

**Note: Hose must be removed from hose door when cleaning carpet and rugs to insure proper cleaning performance.**

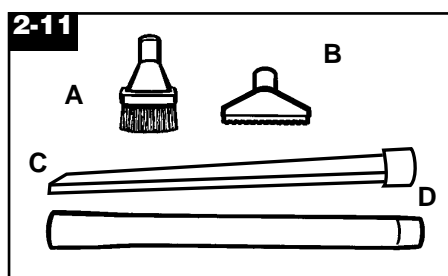

## B. Select proper cleaning tool

**A. Dusting brush** can be used for carved furniture, table tops, books, lamps, lighting fixtures, venetian blinds, baseboards, shutters, and registers.

**B. Furniture nozzle** can be used for upholstered furniture, draperies, tapestries, mattresses, clothing, automobile interiors, and carpeted stairs.

**C. Crevice wand** can be used in tight spaces, corners and along edges in such places as dresser drawers, upholstered furniture, stairs, and baseboards. It can also be used for extra reach with the dusting brush and/or extension wand.

**D. Extension wand** is used to give extra length to your hose. Attach it to any of the above tools.

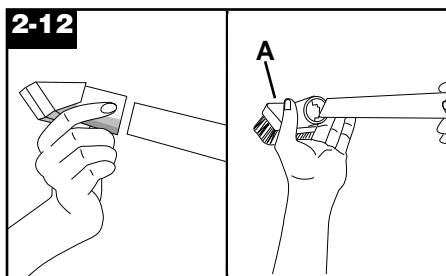

## C. Attach wand and tools

The tools are attached to the hose or the wand in the same manner.

Push tool firmly onto hose; twist tool slightly to tighten or loosen connection.

The dusting brush (A) also can be attached to the crevice wand.

## How to clean tools

To clean the hose, wipe off dirt with a cloth dampened in a liquid detergent. Rinse with a damp cloth.

Cleaning tools may be washed in warm water with a detergent. Rinse and air dry before using.



## 3. Maintenance

Familiarize yourself with these home maintenance tasks as proper use and care of your cleaner will ensure continued cleaning effectiveness.

### Filter bag

#### When to replace

Check filter bag from time to time. It is recommended that you change the filter bag when dirt reaches the dotted line. If more dirt than this accumulates, your cleaner may not operate effectively.

**NOTE:** Check and change the filter bag frequently when using cleaner on new carpet due to rapid accumulation of carpet fluff.

**CAUTION:** Very fine materials, such as face powder, cornstarch, fireplace ashes or fireplace soot, may seal the paper bag and may cause it to burst even though it is only partially full of dirt. When cleaner is used to remove material of this nature, change the filter bag often.

#### Where to buy

Filter bags may be purchased from your local Authorized Hoover Dealer (Depot), Leading Retailers, from Hoover Factory Service Centers, using the order form packed with your cleaner, or through The Hoover Company online at [www.hoover.com](http://www.hoover.com).

**When ordering bags, be sure to give the model number of your cleaner.**

#### What to buy

If your cleaner was originally equipped with a micro filtration bag, it is important to use only **Genuine HOOVER® Allergen Filtration Type Z** disposable bags in order to **maintain the original cleaning effectiveness of your cleaner.**

Regular **HOOVER® Type Z** disposable filter bags also fit your cleaner.

To assure that your cleaner operates at peak performance, it is imperative that you use only genuine HOOVER filter bags distributed by The Hoover Company. HOOVER bags can be identified by these trademarks –

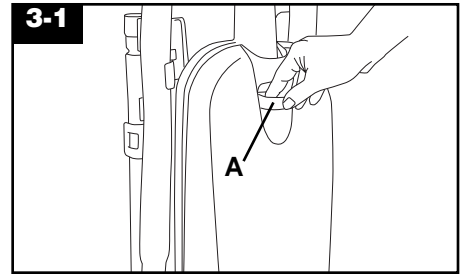

### Changing filter bag

**Disconnect cleaner from electrical outlet.**

#### Removing bag door

Pull bag door latch (A) forward and remove door from cleaner.

Grasp bag collar and pull collar from tube.

**Note:** Do not clean out old bag and reuse. Discard used bag.

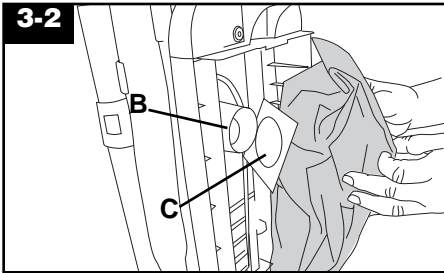

### Removing and installing filter bag

Align opening in new filter bag with dirt tube (B) inside bag compartment. Push bag collar (C) firmly onto tube.

Tuck top and bottom of bag into bag compartment.

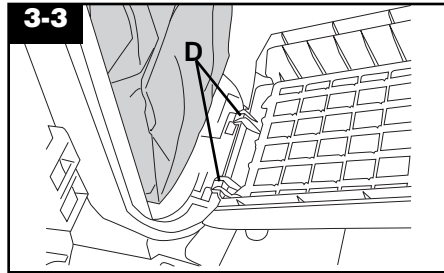

### Replacing bag door

To replace bag door, lift up lower edge of filter bag. Insert the 2 tabs (D) on bottom of bag door into the 2 slots on bag compartment.

**Make sure all edges of filter bag are completely inside the bag compartment.**

Close door.

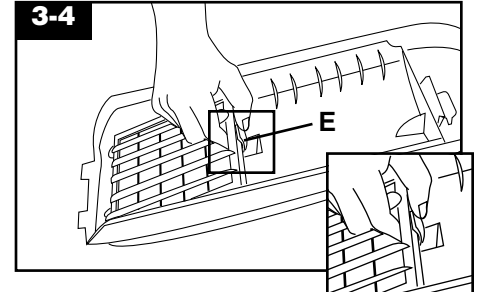

### Final filter

The final filter, located inside the bag door, assists in the filtration process to return clean air to the room. The filter can be cleaned when it becomes dirty.

#### How to clean

**Disconnect cleaner from electrical outlet.**

#### Removing filter retainer

Remove filter bag door (Fig. 3-1).

Open filter retainer at (E) and remove retainer.

**Continued →**

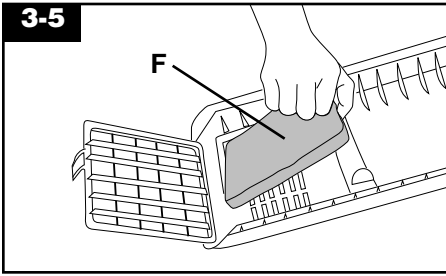

### Removing filter

Lift out filter (F) and hand wash it in cold water with mild detergent.

Let filter air dry and reposition it on the front of the cleaner. Reposition retain-er and filter bag door.

Should you want to replace this filter, ask for HOOVER **part No. 38765024.**

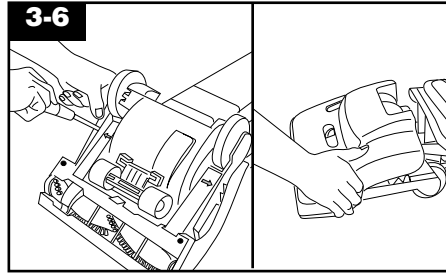

### Headlight What to buy

This cleaner uses a 12 volt, wedge base type 912 bulb, Hoover **part No. 27313-101.**

### How to replace

**Disconnect cleaner from electrical outlet.**

### Removing hood

Place handle in low position and turn cleaner over.

Hood snaps off by inserting the end of a flat screwdriver into one of the areas (labeled with an arrow) on either side of the cleaner as shown. Push screwdriver outward to release hood. Repeat on the other side and remove hood.

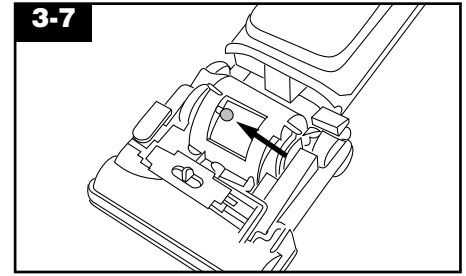

### Installing bulb and reposition- ing hood

Pull old bulb straight out of socket. Push new bulb straight into socket until locked in place.

**Excessive force is not required.**

Reposition hood and push firmly to snap it into place on the sides and at the front.

**Note:** It is not necessary to turn the cleaner over and use a screwdriver to remove the hood once you are familiar with the 2 places on the hood (indicated by arrows in Fig. 3-6) that unlatch it. Simply pull the sides of the hood out-ward at those areas and lift off the hood.

## Belt replacement

The belt on your HOOVER cleaner causes the agitator to rotate and is important for the effective operation of the cleaner. The belt is located under the bottom plate of the cleaner and should be checked from time to time to be sure it is in good condition.

### When to replace

To check belt, remove bottom plate as shown in "How to replace." Replace belt if it is stretched, cut or broken.

### What to buy

To assure effective operation, use only genuine HOOVER belts with your cleaner. When purchasing a new belt, ask for Hoover **part No. 40201190.**

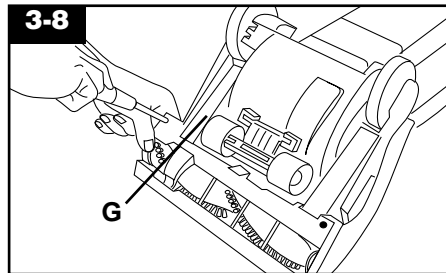

### How to replace

#### Removing bottom plate

**Disconnect cleaner from electrical outlet.**

Place handle in low position and turn cleaner over.

Remove the 2 screws as shown with a Phillips screw driver.

Lift bottom plate at (G) and rotate it off the cleaner.

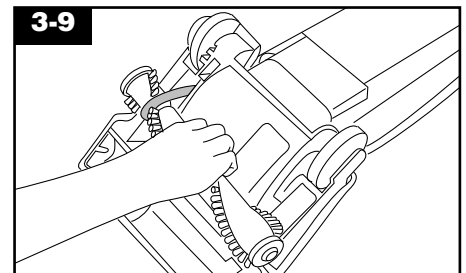

### Removing used belt

Remove agitator brush roll and used belt.

Discard used belt.

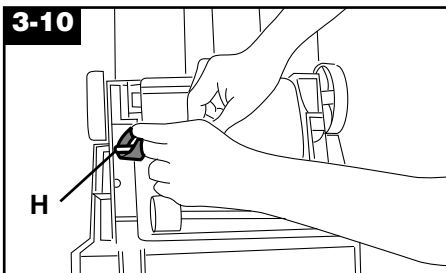

### Positioning belt over pulley

With lettering on outside of belt, pinch belt into a loop and twist slightly to slide new belt over motor pulley (H).

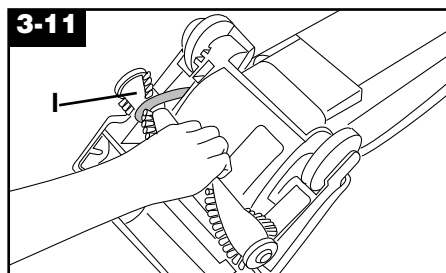

### Positioning belt over brush roll

Insert brush roll through belt and place belt in belt guide (I) on brush roll.

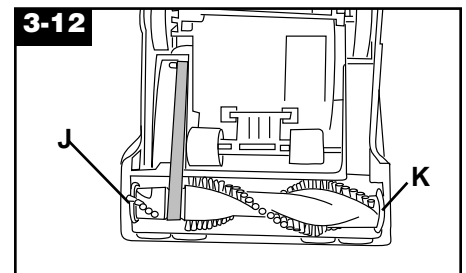

### Installing brush roll

Grasp brush roll firmly and fit it into position by first sliding belt side into the rec-tangular slot (J) on side of cleaner.

Pull other side of brush roll (K) into place. Turn brush roll making sure belt is not pinched between brush roll and cleaner base.

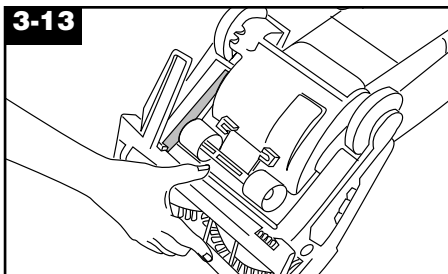

### Replacing bottom plate

Line up bottom plate with front edge of cleaner and rotate it into position.

Reposition the 2 Phillips head screws. Tighten screws securely.

## Agitator brush roll replacement

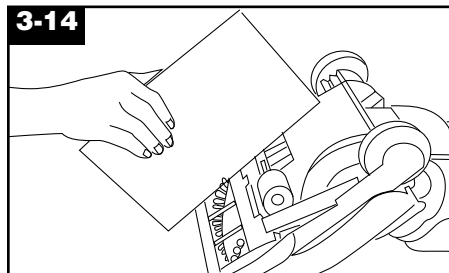

### When to replace

#### Disconnect cleaner from electrical outlet

When brush roll brushes are worn, it should be replaced.

To check condition of brushes, move edge of a card across bottom plate while turning brush roll. To maintain cleaning effectiveness, replace brush roll if brushes do not touch card.

## What to buy

When purchasing a new brush roll, as for Hoover **part No. 48414-081**.

## How to replace

#### Disconnect cleaner from electrical outlet.

1. Remove bottom plate, belt and brush roll following directions for Fig. 3-8 and 3-9.
2. Discard old brush roll
3. Continue following the directions for "Belt replacement" starting with Fig. 3-11 to reposition belt, new brush roll and bottom plate.

## Lubrication

The motor is equipped with bearings which contain sufficient lubrication for the life of the motor. The addition of lubricant could cause damage. **Do not add lubricant to motor bearings.**

The agitator is equipped with two ball bearings that should be lubricated periodically by a Hoover Factory Service Center or an Authorized Hoover Warranty Service Dealer (Depot).

## Service

To obtain approved HOOVER service and genuine HOOVER parts, locate the nearest **Hoover Factory Service Center or Authorized Hoover Warranty Service Dealer (Depot)** by:

- checking the Yellow Pages under "Vacuum Cleaners - Household" OR -
- checking the list of Factory Service Centers provided with this cleaner OR -
- checking the Service section of The Hoover Company on-line at **www.hoover.com** OR -
- calling 1-800-944-9200 for an automated referral of authorized service outlet locations (U.S. only).

**Do not** send your cleaner to The Hoover Company in North Canton for service, this will only result in delay.

If further assistance is needed, contact The Hoover Company Consumer Response Center, North Canton, Ohio 44720, Phone: 330-499-9499.

**In Canada**, contact Hoover Canada, Burlington, Ontario L7R 4A8, Phone: 1-800-263-6376.

Always identify your cleaner by the **complete** model number when requesting information or ordering parts. (The model number appears on the bottom of the cleaner.)

## Hoover Cleaning Performance

This Hoover Cleaning Performance System is for comparing the relative progressive performance of **Hoover uprights only** and not for comparison with any other brands. The majority of this rating is based upon the ASTM International Carpet Cleaning Effectiveness Testing (ASTM Test F608). Other performance factors include Hose Power (ASTM Test F558), Surface Litter Cleaning, Hard Floor Cleaning, Edge Cleaning, Cleaning Width, and Air Filtration.

## 4. If you have a problem

If a minor problem occurs, it usually can be solved quite easily when the cause is found by using the check list below.

### Problem: Cleaner won't run

**Possible cause**  
*Possible solution*

- **Not firmly plugged in**
  - Plug unit in firmly
- **No voltage in wall plug**
  - Check fuse or breaker
- **Blown fuse/tripped breaker**
  - Replace fuse/reset breaker

### Problem: Cleaner won't pick up

**Possible cause**  
*Possible solution*

- **Broken or worn belt**
  - Replace belt
- **Brush roll brushes worn**
  - Replace brush roll
- **Filter bag full**
  - Change filter bag
- **Hose still plugged into cleaner**
  - Remove hose from hose door
- **Incorrect carpet height setting**
  - Move carpet height control to type of carpet being cleaned
- **Brush roll cavity clogged**
  - Clear blockage (see "Clearing blockages" section)

### Problem: Cleaning tools won't pick up

**Possible cause**  
*Possible solution*

- **Hose clogged**
  - Clear blockage (see "Clearing blockages" section)
- **Hose connector inserted incorrectly**
  - Insert hose connector properly (see "Cleaning tools" section)

### Problem: Cleaner hard to push

**Possible cause**  
*Possible solution*

- **Incorrect carpet height setting**
  - Move carpet height control to a higher setting

## Clearing blockages

Remove large items from surfaces before vacuuming to prevent blockages and to maintain cleaning effectiveness of your cleaner.

Refer to the following steps to check for blockages **continuing with each step until the blockage is found.**

### A. If a blockage occurs during tool use:

**Turn cleaner OFF and disconnect it from the electrical outlet.**

1. Remove hose from hose door, look into end of hose and remove any blockages.

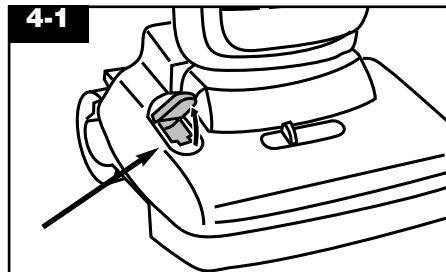

2. Open hose door. Look inside and toward back of opening. Remove any blockages.

### B. If a blockage occurs during floor cleaning: **Turn cleaner OFF and disconnect it from electrical outlet.**

1. Turn cleaner to expose underside. Remove bottom plate and brush roll as shown for Figs. 3-9 and 3-10.

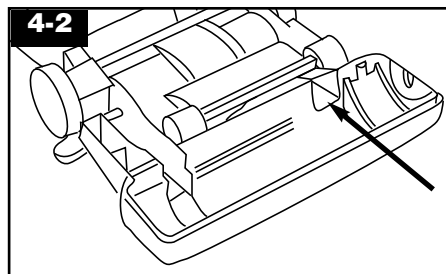

2. Carefully remove any blockage from brush roll cavity. Reposition brush roll and bottom plate as shown in Figs. 3-12 through 3-14.

**If a blockage is not found and a problem persists, contact your Hoover Factory Service Center or Authorized Warranty Service Dealer (Depot).**

## Full One Year Warranty (Domestic Use)

Your HOOVER® appliance is warranted in normal household use, in accordance with the Owner's Manual against original defects in material and workmanship for a period of one full year from date of purchase. This warranty provides, at no cost to you, all labor and parts to place this appliance in correct operating condition during the warranted period. This warranty applies when the appliance is purchased in the United States including its territories and possessions, or in Canada or from a U.S. Military Exchange. Appliances purchased elsewhere are covered by a limited one year warranty which covers the cost of parts only. This warranty does not apply if the appliance is used in a commercial or rental application.

Warranty service can only be obtained by presenting the appliance to one of the following Authorized Warranty Service outlets. Proof of purchase will be required before service is rendered.

1. Hoover Factory Service Centers
2. Hoover Authorized Warranty Service Dealers (Depots)

**For an automated referral of authorized service outlets in the U.S.A., phone 1-800-944-9200 OR**

**visit The Hoover Company on-line at [www.hoover.com](http://www.hoover.com)**

This warranty does not cover pick up, delivery, or house calls; however, if you mail your appliance to a Hoover Factory Service Center for warranty service, transportation will be paid one way.

While this warranty gives you specific legal rights, you may also have other rights which vary from state to state (or province).

If further assistance is needed, or if there are questions concerning this warranty or the availability of warranty service outlets, write or phone the Consumer Response Center, The Hoover Company, 101 East Maple St., North Canton, Ohio 44720. Phone 330-499-9499.

In Canada, contact Hoover Canada, Burlington, Ontario, L7R 4A8. Phone 1-800-263-6376.

HOOVER y  son marcas registradas

HOOVER et  sont des marques déposées

HOOVER and  are registered trademarks