

GRACO[®]

Car Seat/ Booster Seat

OWNER'S MANUAL
Model 8480



⚠ WARNING

Even if using this car seat seems easy to figure out on your own, it is very important to read this manual.

Your child's safety depends on you installing and using this car seat correctly. **READ THIS MANUAL!** After following these instructions, return this manual to the storage pocket on the back of the car seat for quick reference.

© 2001 Graco 409-5-01

Table of Contents

| | |
|--|-------|
| 1. Warnings to Parents and Other Users | 4 |
| 2. Important Safety Information | 5-10 |
| 2.1 About Your Child | 5 |
| 2.2 About Using this Car Seat in Your Vehicle | 8 |
| 2.3 When the Car Seat is Not Occupied | 9 |
| 2.4 Life and Condition of the Car Seat | 10 |
| 3. Features and Components | 11-12 |
| 4. Selecting a Suitable Location for the Car Seat | 13-14 |
| 5. Use of the Car Seat with the Built-in Harness | 15-32 |
| 5.1 Positioning the Harness Straps | 15 |
| 5.2 Selecting a Suitable Location for the Car Seat | 19 |
| A. Vehicle Belt Systems that are NOT Safe for Use with the Car Seat | 20 |
| B. Vehicle Belt Systems that ARE Suitable for Use with the Car Seat | 23 |
| 5.3 Positioning and Securing the Car Seat in your Vehicle | 25 |
| 5.4 Securing your Child in the Car Seat | 33 |
| 5.5 Using the Car Seat in an Airplane | 35 |

| | |
|--|-------|
| 6. Use of the Car Seat without the Built-in Harness | 36-43 |
| 6.1 Removing the Built-in Harness | 38 |
| 6.2 Securing your Child and the Booster Seat with the Vehicle Lap/Shoulder Belt | 40 |
| 6.3 Using the Booster Seat in an Airplane | 43 |
| 7. Cleaning and Maintenance | 43-46 |
| 8. Registering Your Car Seat | 47 |
| 9. Replacement Parts | 48 |

**Our goal is to make every product
the best it can be!**

We are also committed to supporting our products after purchase. If you would like to speak to Graco about your product, please call our **Customer Service Department at 1-888-224-6549** or visit our Internet website at www.gracobaby.com.

Our knowledgeable staff is ready to answer any questions you may have concerning parts, use or maintenance. When you call, please have the **model and serial numbers** ready so your call may be processed quickly and efficiently. These numbers can be found on a sticker on the underside of your car seat.

**Keep this manual
in the storage compartment
on the back of the car seat.**

1. Warnings to Parents and Other Users

DO NOT install or use this car seat until you read and understand the instructions in this manual and in your vehicle owner's manual. **DO NOT** let others install or use the car seat unless they understand how to use it.

Failure to properly use this car seat increases the risk of serious injury or death in a sharp turn, sudden stop or crash. Your child's safety depends on you installing and using this car seat correctly.

Your child's safety depends on:

1. **Choosing the correct use mode** of the car seat depending on your child's size.
2. **Inserting the harness straps** (if needed) in the proper slots for your child.
3. **Selecting a suitable location** for the car seat in your vehicle.
4. **Properly routing the vehicle seat belt.**
5. **Properly securing the car seat in the vehicle** using a seat belt designed to restrain the car seat and your child. Many seat belts are NOT safe to use with this car seat, even though they can easily be threaded through or around the car seat.
6. **Properly securing your child** in the car seat.

2. Important Safety Information

No car seat can guarantee protection from injury. However, proper use of this car seat reduces the risk of serious injury or death to your child.

2.1 About Your Child

WARNING

Instructions for the use of this car seat and your vehicle's seat belt differ greatly depending on the size of your child. **Be sure you are using the car seat in the correct mode and with the correct features for your child.** Failure to use the car seat in a manner that is appropriate for your child's size may increase the risk of serious injury or death.

When you switch from one mode of use to another, be sure to review the sections of this manual that apply to that mode.

- **NEVER LEAVE YOUR CHILD UNATTENDED.**
- **NEVER ALLOW THE CHILD TO BUCKLE HIMSELF** into the car seat at any time. This unit must be installed and adjusted **only** by an adult.

Your child should use the built-in harness if:

- child weighs from **20 to 40 lbs.** (9 to 18 kg), and is between **27 and 40 inches** (69 and 102 cm) in height, and
- child is at least **one year old** and can sit upright unassisted, and
- child's shoulders are **below** top harness slots. If shoulders are above top harness slots, child is too large for built-in harness. You **must** remove the harness and use the booster seat with your vehicle's lap and shoulder belt system.

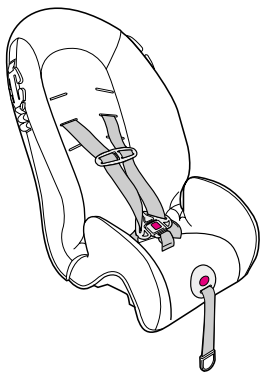

If your child is between 30 and 40 lbs., he should continue to use the harness **if** his shoulders are **below** the upper harness slots. We highly recommend use of the built-in harness for as long as it is suitable and comfortable for your child.



Your child should use the VEHICLE shoulder and lap belts BUT NOT the built-in harness if:

- child weighs from **30 to 80 lbs.** (14 to 36 kg), and is between **35 and 54 inches** (89 and 138 cm) in height, and

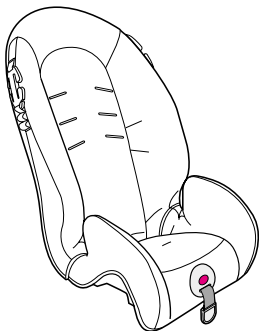

- child's ears are **below** top of booster seat. If tops of ears are above top of seat, child is too large for booster seat.



Without built-in harness →

**80 lbs.
(36 kg)**

2.2 About Using this Car Seat in Your Vehicle

- **YOUR CHILD CAN BE INJURED** in a vehicle even if you are not in a crash. Common events such as sudden braking and sharp turns can injure your child if the car seat is not properly installed or if your child is not properly secured in the car seat.
- **THERE ARE MANY KINDS OF VEHICLES,** seat belt systems and occupant protection systems. As a result, it is not possible for this manual to tell you everything you need to know about putting this car seat in your vehicle. You must carefully follow the instructions provided by your vehicle manufacturer, in addition to the information in this manual.
- **SOME VEHICLES DO NOT HAVE ANY** safe location for this car seat, and many vehicles have seat belt systems that must not be used with the car seat because those systems will not safely hold the car seat or your child in place. Refer to sections 4 and 5.2, "Selecting a Suitable Location for the Car Seat" (pages 13 & 19) and to your vehicle owner's manual for information.
- **THIS CHILD RESTRAINT** conforms to all applicable Federal Motor Vehicle Safety Standards.

- **THIS RESTRAINT** is certified for use in Motor Vehicles. It is certified for use in Aircraft **only** when used with the built-in harness. When used as a booster without the harness, this restraint is **not** certified for use in aircraft. For aircraft use see section 5.5, "Using the Car Seat in an Airplane" on page 35.
- **CONTINUOUS USE OF A CAR SEAT** may cause damage to a vehicle seat. To protect vehicle upholstery, use a car seat mat, towel or thin blanket under the seat.

2.3 When the Car Seat is Not Occupied

- **NEVER LEAVE A CAR SEAT UNSECURED IN YOUR VEHICLE.** When you are not using the car seat, either remove it or make sure that it is securely belted in the vehicle. An unsecured car seat can be thrown around and may injure occupants in the event of a sharp turn, sudden stop or crash.
- **PARTS OF THE CAR SEAT CAN BECOME VERY HOT** if the seat is left in the sun. Contact with these parts can burn your child's skin. Cover the car seat with a blanket if it will be exposed to the sun, and always touch the surface of any metal or plastic parts before putting your child in the car seat.
- **WHEN NOT USING THE CAR SEAT** for long periods, store it in a plastic bag in a cool, dark, dry place.

- **DO NOT PLACE HEAVY OBJECTS ON CAR SEAT** while in storage. Heavy objects may deform car seat over a period of time.

2.4 Life and Condition of the Car Seat

- **REPLACE THE CAR SEAT AFTER AN ACCIDENT** of any kind. An accident can cause damage to the car seat that you cannot see.
- **EVEN IF THE CAR SEAT IS NOT INVOLVED IN AN ACCIDENT**, stop using it and throw it away after the date molded into the back of the car seat. Example: "Do not use this child restraint after December 2006."
- **DO NOT MODIFY YOUR CAR SEAT** or use any accessories or parts supplied by other manufacturers. Only make adjustments to the car seat as recommended in these instructions.
- **NEVER USE THE CAR SEAT IF IT HAS DAMAGED OR MISSING PARTS.** Do not use a cut, frayed or damaged car seat harness or vehicle seat belt.
- **NEVER GIVE THIS CAR SEAT TO SOMEONE ELSE** without also giving them this manual.
- **NEVER USE A SECOND-HAND CAR SEAT** or a car seat whose history you do not know.

3. Features and Components

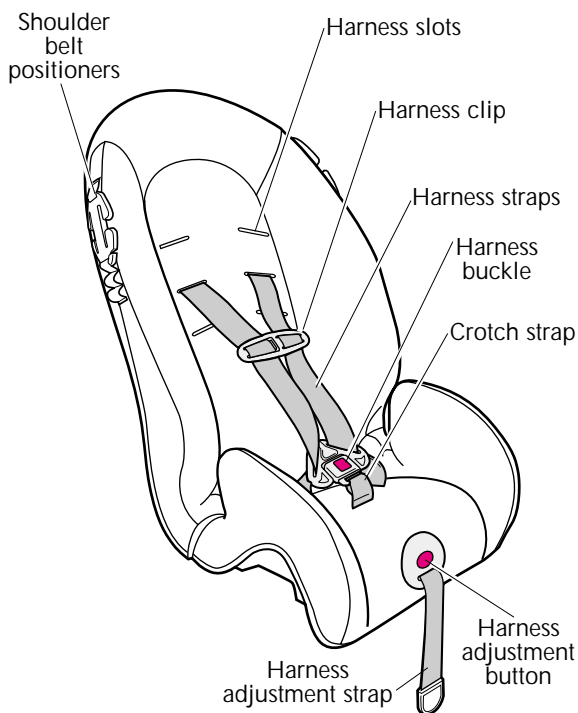

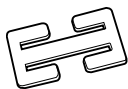
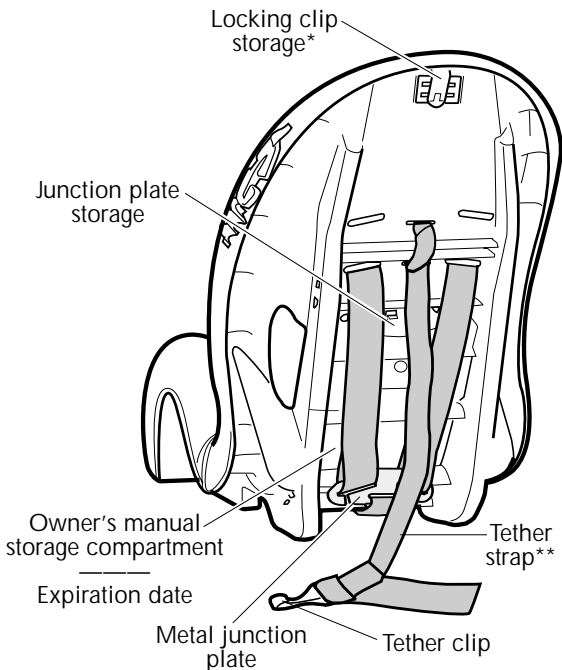

*The locking clip is stored on the back of the car seat. You will need to use it with certain types of vehicle seat belts.

**Some vehicles are now (or can be) equipped with tether anchor points behind some vehicle seats. A tether anchors the top of the car seat to the body of the vehicle. When used properly with the vehicle seat belt, a tether helps reduce injury in a sharp turn, sudden stop or crash.

4. Selecting a Suitable Location for the Car Seat

Following are some basic recommendations for **both** use modes of the car seat. See section 5, "Use of the Car Seat with the Built-in Harness" (page 15) for more information about a safe location for the car seat in that mode.

According to accident statistics, children are safer when properly restrained in rear vehicle seating positions, rather than front seating positions. For a vehicle with a front passenger air bag, refer to your vehicle owner's manual as well as these instructions for car seat installation.

We recommend that, whenever possible, you secure the car seat in the center position of the



seat directly behind the front seats ¥. However, this position is often only equipped with a lap belt and cannot be used when this car seat is used without the built-in harness.

If you want to use the tether, locate a seating position equipped with tether anchors. If your vehicle does not have a tether anchor, it may be possible to install one. Contact your vehicle dealership for the proper anchor location and installation. A tether anchor parts kit may be purchased by calling Graco Customer Service at 1-888-224-6549.

Be Sure Your Vehicle Seat Meets These Requirements

- **THE VEHICLE SEAT MUST FACE FORWARD.** DO NOT place car seat in a rear-facing vehicle seat ¥ or a side-facing vehicle seat † .



- **DO NOT** use this car seat in any vehicle seat in which the front of the car seat hangs over the edge of the vehicle seat § .

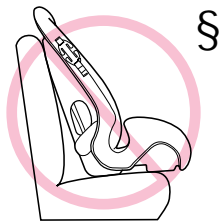

5. Use of the Car Seat with the Built-in Harness

Use of this car seat with the built-in harness is meant for a child:

- who weighs from **20 to 40 lbs.** (9 to 18 kg) and is between **27 and 40 inches** (69 and 102 cm) in height, and
- who is at least **one year old** and can sit upright unassisted, and
- whose shoulders are **below** top harness slots. If shoulders are above top harness slots, child is too large for built-in harness. You **must** remove the harness and use the booster seat with your vehicle's lap and shoulder belt system.

5.1 Positioning the Harness Straps

⚠ WARNING

Failure to properly adjust the harness straps for your child increases the risk of serious injury or death in the event of a sharp turn, sudden stop or crash. The harness straps must be properly adjusted to fit your child according to the following instructions.

Note that there are three positions for the shoulder harness straps. The harness straps must go into the slots that are **even with or just above your child's shoulders** .

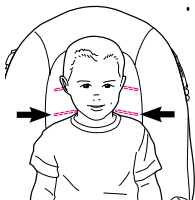

To properly adjust the harness to your child:

1. Loosen the harness straps by **fully pushing in the red adjustment button** on the front of the seat and pulling the straps out at the shoulders as shown ¥ .

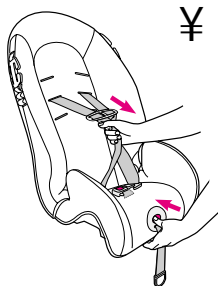

2. Unthread one strap from the harness clip | .

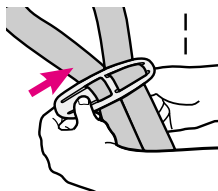

3. Push the red release button on the buckle of the crotch strap § . Unbuckle both harness straps. Move the straps apart to make room for your child.

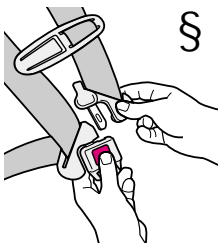

4. Place your child in the seat with his bottom flat against the seat back.
5. Determine which pair of harness slots is even with or just above your child's shoulders.

6. To adjust the position of the harness straps, remove your child from the car seat in order to make the adjustment. Look behind the car seat to locate the ends of the straps as they loop around the metal junction plate.

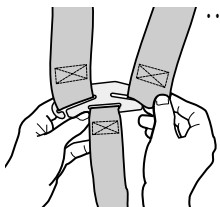

Remove the ends of the two shoulder straps from the junction plate " .

7. From the front of the car seat, pull the strap ends through the slots © and reinsert them through the appropriate slots as determined in step 5 above.

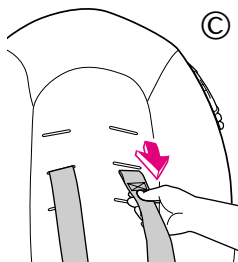

8. Behind the car seat, reassemble the straps onto the metal junction plate. Check that straps are completely within the slots as shown ^a .

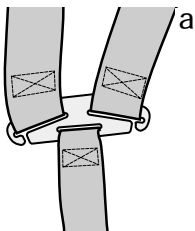

9. Inspect the harness straps from the front and back of the car seat to be sure the straps are inserted at the same level and that they are not twisted. Twisted belts can create slack in the harness straps and reduce the protection provided by the car seat.
10. Pull on the harness straps from the front of the car seat to be sure the straps are secure.
11. Check the crotch strap.

There are two possible positions for it. Choose the position that is closest to but not under your child.

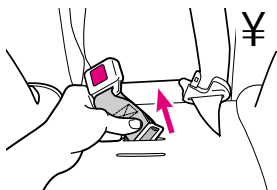

If you need to move the strap, reach under the seat and push the metal retainer up through the slot sideways ¥ . Push it back down through the appropriate slot (making sure the red button faces out) and tug on it to be sure that it is properly secured.

The components of your harness are now properly positioned for your child. You will fine-tune the fit each time you place your child in the car seat by using the adjustment strap.

Remember to check the shoulder and crotch straps as your child grows and move them to the next position when necessary.

5.2 Selecting a Suitable Location for the Car Seat

WARNING

Some seating positions in your vehicle may not be safe locations for this car seat when used with the built-in harness. In fact, some vehicles do not have **any** seating positions that can be used safely with the car seat.

Improper placement of the car seat increases the risk of serious injury or death.

Follow the instructions in this section and in your vehicle owner's manual to select a location for the car seat. If you are not sure where to place the car seat in your vehicle, contact your vehicle manufacturer or Graco Children's Products Inc., 1-888-224-6549.

Be Sure Your Vehicle Seat Belt Meets These Requirements

The vehicle seat belt must be designed to hold the car seat tightly at ALL times. There are a variety of seat belt systems that are NOT safe for use with the car seat because they will not hold the car seat tightly at all times. We will first describe the seat belts that are NOT safe for use and then we will describe those that ARE safe for use. Pay careful attention to these systems; some of the seat belts that are not safe to use look very much like seat belts that are safe to use. If you are unsure, contact the vehicle manufacturer or call Graco at 1-888-224-6549.

WARNING

Many seat belt systems are NOT safe to use with the car seat, even though they can easily be threaded through the car seat. Carefully read this section for information on seat belt systems and refer to your vehicle owner's manual and any labels on your vehicle's seat belt. You may need to have a special seat belt installed by your vehicle dealer before using the car seat.

A. Vehicle Belt Systems that are NOT Safe for Use with the Car Seat

DO NOT use the following types of vehicle belt systems with your car seat. They will not hold the car seat securely in place. The metal locking clip provided with this product will NOT make any of these vehicle belts safe.

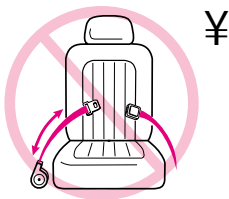

- **DO NOT** use a lap belt that stays loose and can move until it locks in a crash or sudden stop ¥ . This belt has an Emergency Locking Retractor, E.L.R. It is often seen in combination with a motorized shoulder belt. Since these lap belts will loosen if pulled on slowly, the car seat may shift to an unsafe position. This vehicle belt will NOT safely restrain the car seat. However, you may be able to convert your E.L.R. belt to one that is safe to use. See your vehicle owner's manual for more information or contact your vehicle manufacturer.

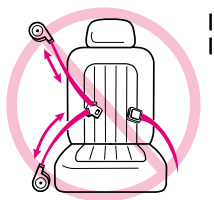

- **DO NOT** use a lap/shoulder combination belt where each strap has a retractor at one end and is attached to the latchplate at the other end of the belt | . This vehicle belt will NOT safely restrain the car seat.

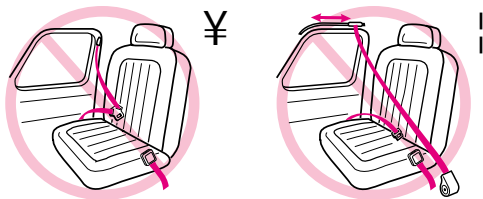

- **DO NOT** use vehicle belts that are attached to the door in any way ¥ or that move along a track to automatically surround the passenger when the door is closed ! . These vehicle belts will NOT safely restrain the car seat.

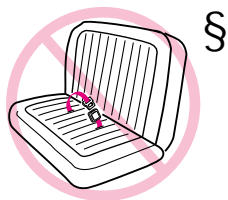

- **DO NOT** use a vehicle belt that is anchored forward of the seat crease § . This vehicle belt will NOT safely restrain the car seat.

If you have one of the above vehicle belt systems, **DO NOT** use it to secure the car seat. Look for a vehicle seat location that has a suitable seat belt (see the next section) or contact your vehicle manufacturer about installing a seat belt system that can be used to secure the car seat.

B. Vehicle Belt Systems that are Suitable for Use with the Car Seat

The following vehicle belt systems can be used with your car seat, IF the seat location meets all other requirements of these instructions AND THOSE IN YOUR VEHICLE OWNER'S MANUAL.

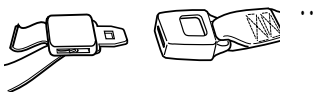

- **Lap belt that is manually adjusted and stays tight** . This type of vehicle belt is tightened by pulling on the excess belt once it is buckled. This type of vehicle belt is most often found in the rear center seating position. A lap belt can only be used in combination with the built-in harness of the car seat. To use the car seat without the built-in harness, you must use a vehicle seat with a lap/shoulder belt.



- **Lap belt that cannot lengthen once it is buckled** ©. This belt has an automatic locking retractor (A.L.R.) that does not allow the vehicle belt to lengthen without unbuckling the belt and starting over. A lap belt can only be used in combination with the built-in harness of the car seat. To use the car seat without the built-in

harness, you must use a vehicle seat with a lap/shoulder belt.

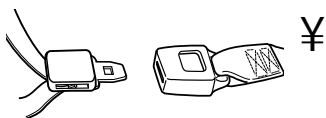

- **Lap/shoulder combination belt with a locking latchplate ¥.** Once it is buckled, this type of belt has a latchplate that will not allow the lap portion of the belt to loosen. This vehicle belt does not require a locking clip.

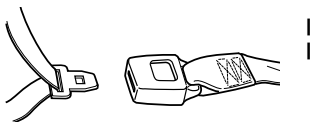

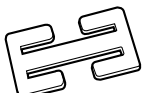
- **Lap/shoulder combination belt with a latchplate that can slide freely along the belt |.** This type of belt **MUST** be converted to prevent movement of the lap portion of the belt. You must use the locking clip provided with  the car seat (see “To install the locking clip” on page 29), unless your vehicle’s seat belt can be converted in another way that is described in your vehicle owner’s manual. Failure to use the locking clip or convert the seat belt in another way will allow the car seat to move out of position. See your vehicle owner’s manual or contact your vehicle manufacturer for more information.

5.3 Positioning and Securing the Car Seat in Your Vehicle

Installation of your car seat varies depending on the type of seat belt system you have in your vehicle. Carefully review the following pages to determine the proper installation requirements.

There are many kinds of vehicles, seat belts, and occupant protection systems. As a result, it is not possible for this manual to tell you everything you need to know about putting this car seat in your vehicle. You must carefully follow the instructions provided by your vehicle manufacturer, in addition to the information in this manual. Before proceeding, be sure you have read and understood the section on safe and unsafe vehicle belt systems.

WARNING

Failure to properly secure the car seat in the vehicle increases the child's risk of serious injury or death in the event of a sharp turn, sudden stop or crash.

Carefully follow these instructions and those in your vehicle owner's manual to be sure your car seat is properly located, positioned, and held tightly at all times.

1. Make sure you have selected a suitable location for the car seat as explained in sections 4 and 5.2, "Selecting a Suitable Location for the Car Seat" (pages 13 & 19).

2. If a front passenger seat is used, slide the vehicle seat rearward as far as possible from the dashboard. If a rear seat is used, make sure the seat in front of it is moved forward enough and is upright enough to allow room for the car seat.
3. Be sure that the vehicle seat back is locked in position.
4. Place the car seat firmly against the back of a forward-facing vehicle seat. If you are using the tether, lay it over the back of the vehicle seat so it won't get hidden behind the back of the car seat.
5. Thread the seat belt:

Follow diagram
 ¥ if you are
 using a
 lap/shoulder
 belt

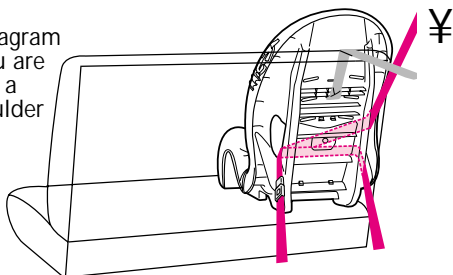

Follow diagram
 | if you are
 using a lap-only
 belt

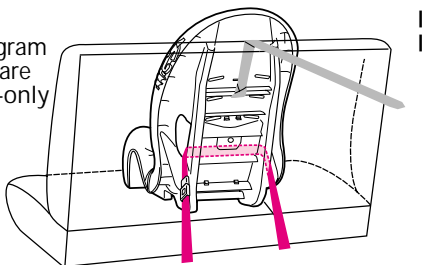

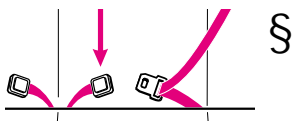

6. Buckle the vehicle belt. Make sure the buckle tongue goes into the correct buckle, and not the adjacent one § . The vehicle belt should not be twisted or turned.

7. Now the vehicle seat belt must be tightened.

Push down hard with your knee or free hand in the middle of the car seat " . Then pull and tighten the vehicle belt.

- If you have a lap-only belt, go to step 8.
- If you have a lap/shoulder combination belt, go to step 9.

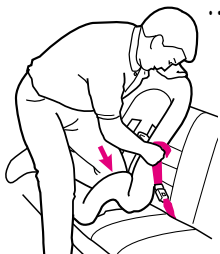

8. **Tightening a lap-only belt:**

- An **automatically adjusted lap belt** © is tightened by feeding the vehicle belt back into its retractor while pushing down hard on the car seat. Make sure that vehicle belt is locked in place and very tight.

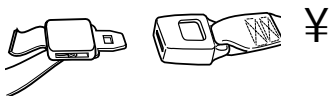

- A **manually adjusted lap belt** ¥ is tightened by pulling on the excess belt while pushing down hard on the car seat. However, you may have trouble tightening the belt because of the upright angle at which you must pull. You may have to unbuckle the vehicle belt, estimate a belt length that will make the vehicle belt very tight, then buckle it again.

9. Tightening a lap/shoulder combination belt:

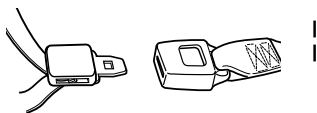

- A **lap/shoulder combination belt with a locking latchplate** | is tightened by pulling hard on the shoulder portion of the vehicle belt while pushing down hard on the car seat. However, you may have trouble tightening the belt because of the upright angle at which you must pull. You may have to unbuckle the vehicle belt, estimate a belt length that will make the vehicle belt very tight, then buckle it again.

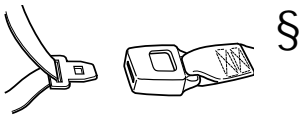

- A lap/shoulder combination belt with a latchplate that can slide freely along the belt § requires the locking clip, unless your vehicle's seat belt can be converted in another way that is described in your vehicle owner's manual. See your vehicle owner's manual to find out if your vehicle belt can be converted to prevent movement of the lap portion of the belt. Otherwise, the locking clip **MUST** be used.

10. To install the locking clip:

- Tighten the buckled vehicle belt by pushing down hard on the car seat and pulling hard on the shoulder belt.
- While continuing to push down on the car seat, let go of the shoulder strap and pinch the two straps together just behind the buckle tongue.
- While still pinching the straps together, unbuckle the vehicle belt. Do not allow the straps to slip.
- Connect the lap belt to the shoulder belt by placing the locking clip on the belts about $\frac{1}{2}$ inch from the buckle tongue as shown .

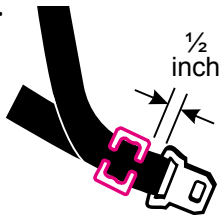

e. Re-buckle the belt and pull hard on the lap belt to be sure it does not move.

f. Repeat this procedure if the lap belt is loose or lengthens when pulled.

Remove locking clip from vehicle seat belt when not being used with a car seat. The belt will not properly restrain an adult or child and serious injury could occur. Store locking clip under its tab on the back of the car seat.

Do not use locking clip as a vehicle belt shortener.

11. To secure the tether:

a. Make sure tether is securely attached to the car seat.

b. Fasten the tether clip to the anchor point ¥.

Styles and locations of the anchor points vary.

Consult your vehicle owner's manual about how to use an anchor point in your vehicle.

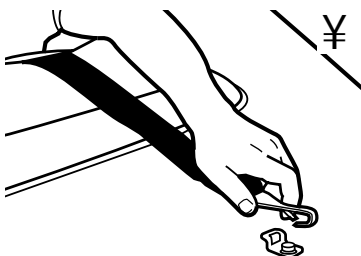

c. Tighten the tether strap securely. To tighten, pull on free end of strap |.

You may need to retighten the vehicle belts after tether installation.

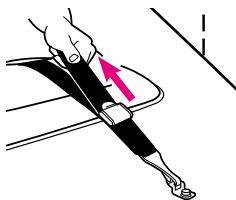

d. To loosen, lift up on the metal tongue of the buckle §.

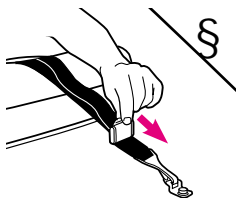

When not using tether, place tether behind car seat or tuck between vehicle seat back and bottom.

Safety Check

12. Make sure that the car seat is properly secured by the vehicle seat belt system by performing the following test **EVERY TIME YOU DRIVE WITH YOUR CHILD:**

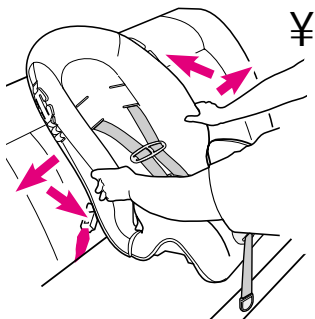

Holding the car seat near the vehicle belt path, Twist and pull the car seat firmly forward and to both sides to make sure the vehicle seat belt does not lengthen or loosen and the car seat does not easily move ¥ .

If you find that your car seat shifts or your vehicle seat belt slips or becomes loose, check that you have followed steps 1-11 correctly, or see sections 4 and 5.2, "Selecting a Suitable Location for the Car Seat" (pages 13 & 19).

DO NOT USE ANY SEATING LOCATION WHERE THE VEHICLE BELT DOES NOT HOLD THE CAR SEAT TIGHTLY.

5.4 Securing Your Child in the Car Seat with the Built-in Harness

WARNING

Failure to properly secure your child in the car seat increases the risk of serious injury or death in the event of a sharp turn, sudden stop or crash.

In a crash, the car seat provides NO protection for your child unless the harness straps are properly secured.

Follow these instructions carefully to properly secure your child.

Adjust the harness system snugly every time you place your child in the car seat. Be aware that something as simple as changing a jacket may require a change in the length of the harness. By pulling the adjustment strap, the whole system tightens and fits to your child's size. To secure your child, follow these steps:

1. Make sure that the harness and crotch straps are properly positioned for your child according to section 5.1, "Positioning the Harness Straps" (page 15).
2. Avoid bulky clothing. Make sure that your child is dressed in clothing which:
 - a. Allows the harness straps to securely latch into the crotch buckle between your child's legs.
 - b. Keeps the straps on your child's shoulders.

3. Place your child in the car seat so that the child's bottom rests against the back of the car seat.

4. Pull the harness straps around your child (push the red adjustment button and pull on the shoulder straps to lengthen them if needed) and snap each buckle tongue into the buckle of the crotch strap ¶ . Make sure that you

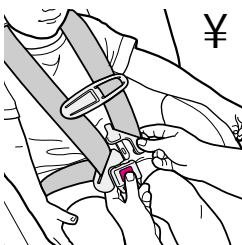

hear a "click" and check that the harness is securely latched by pulling the straps away from the buckle. If the harness straps are not buckled, the car seat provides NO protection for your child. DO NOT use the car seat if the harness does not latch in place. Call Graco at 1-888-224-6549.

5. Check that the harness straps are not twisted. Pull on the adjustment strap to securely tighten the harness ¶ .

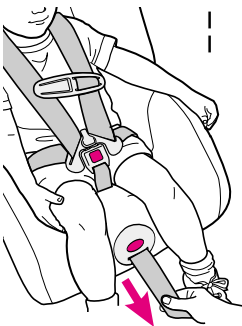

Make sure that both straps are flat and tight against your child's shoulders. You should not be able to insert more than one finger between the harness and your child's shoulder § .



6. Rethread the shoulder harness strap through the harness clip .
7. Position the harness clip at the middle of the child's chest, level with the armpits and away from the child's neck.

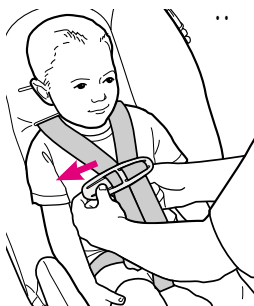

Final Safety Check

8. Check that harness straps are tight and not twisted. Check that the harness clip and all buckles are securely fastened. Recheck that the seat is tightly held by the vehicle belt.

5.5 Using the Car Seat in an Airplane

- This car seat may be installed in an airplane **ONLY** for a child between 20 and 40 lbs., and **ONLY** when the **built-in harness is used**.



Since airlines have some restrictions about the use of car seats, notify the airline ahead of time that you intend to bring the car seat on board.

- For the safety of your child, use the car seat in **forward-facing** aircraft seats only. Follow the flight attendant's instructions about car seat placement. Install your car seat on an airplane the same way it is installed in an automobile.
- Always be sure that the airplane seat belt is adjusted so that it tightly holds the car seat in place at all times.

6. Use of the Car Seat without the Built-in Harness

Use of this car seat as a booster without the built-in harness is meant for a child:

- who weighs from 30 to 80 lbs. (14 to 36 kg), and is between 40 and 54 inches (102 and 138 cm) in height, and
- whose ears are **below** top of booster seat. If tops of ears are above top of seat, child is too large for booster seat.

If your child is between 30 and 40 lbs., he should continue to use the harness if his shoulders are **below** the upper harness slots. We highly recommend use of the built-in harness up to 40 lbs.

DO NOT use the car seat in this manner with a lap-only belt.

⚠ WARNING

Failure to properly secure your child and the booster seat in your vehicle increases the risk of serious injury or death in the event of a sharp turn, sudden stop or crash. The vehicle restraint straps must be properly positioned to fit your child according to the following instructions and those in your vehicle owner's manual.

In a crash, the booster seat provides **NO** protection for your child unless the vehicle lap and shoulder belts are properly secured. Use only the vehicle's lap and shoulder belt system when restraining the child in this booster seat.

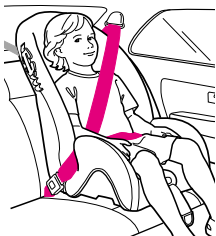

NEVER use a vehicle lap-only belt across front of child; severe abdominal, head and/or neck injuries or death may result in the event of a sharp turn, sudden stop or crash.

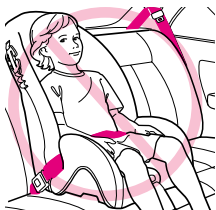

Vehicle belts **MUST** lay flat against child and **MUST NOT** be twisted.

⚠️ WARNING

DO NOT use shoulder belt loose or positioned under arm.

Lap portion of lap/shoulder belt MUST be low and snug on hips, just touching thighs.

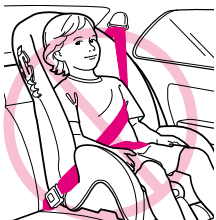

DO NOT allow child to slide down in booster seat. This could position vehicle lap belt across child's abdomen and vehicle shoulder belt over neck or face. If child will not keep vehicle restraint properly positioned, DO NOT use this booster seat. Use a different child restraint system.

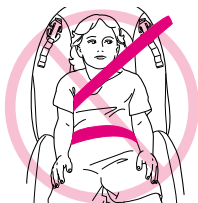

6.1 Removing the Built-in Harness

The harness of your car seat must be removed when your child's shoulders are above the upper harness slots **or** when your child weighs more than 40 lbs. (18 kg). When removing the harness, be especially careful to keep all the parts on the belts. By keeping these very important parts together, they can be reinstalled on the seat for use with another child. Carefully follow the instructions below.

1. Behind the seat, remove the ends of the two shoulder straps from the metal junction plate (see figure 4, page 17).
2. In front of the seat, pull the strap ends through the slots. **Do not remove the buckles or harness clip from the straps.**

3. Underneath the seat, pull the straps down through the holes in the cover and the seat, guiding the buckles and harness clip as needed ¥.

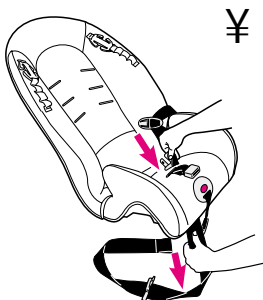

4. To remove the crotch strap, reach under the seat and push the metal retainer up through the slot sideways. Buckle the crotch strap to the harness strap for safekeeping.

5. The metal junction plate and adjustment strap are not removable. Push in the red adjustment button in front of the seat and pull the strap to the rear of the seat so it won't be in the way when not in use †.

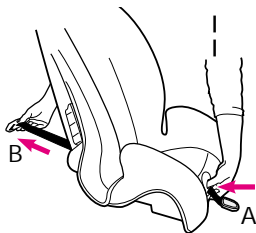

- A. Push in the red button.
B. Pull the strap out the back.

6. Snap the junction plate onto the storage tabs provided for it (see the molded outline of the

plate) on the rear of the seat ¥ .

7. **Store the harness in a cool dry place** until it is needed again. Then reinstall by reversing these instructions. See the illustration on page 46 to check the correct path for the harness.

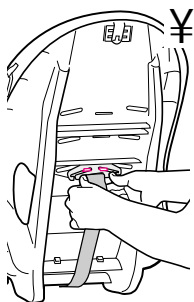

6.2 Securing Your Child and the Booster Seat with the Vehicle Lap/Shoulder Belt

1. Use of the tether is not required when using the seat in this mode; however, it may keep the seat more stable. See section 5.3, step 11, "To secure the tether" (page 31) for instructions on tether use.
2. Place booster seat firmly against the back of a forward-facing vehicle seat suitable for the booster seat as explained in section 4, "Selecting a Suitable Location for the Car Seat" (page 13) and equipped with a lap/shoulder belt. **DO NOT** place booster seat in a seating position that only provides a lap belt. If a front passenger seat is used, slide the vehicle seat rearward as far as possible from the dashboard.
3. Be sure that the vehicle seat back is locked in position.

4. Have your child sit in the seat so that the child's bottom rests against the back of the car seat.
5. Place vehicle lap belt across child's thighs and through the cutouts in the sides of the booster seat. Place shoulder belt in front of the child. Fasten the buckle and pull up on the shoulder belt to tighten | .

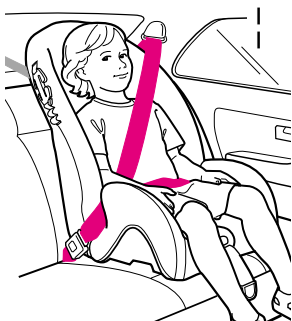

Make sure buckle tongue goes into the correct buckle, and not the adjacent one § . Seat belt should not be twisted or turned.

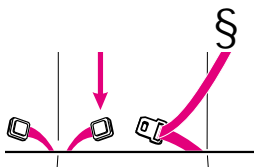

6. If vehicle belt lays across child's neck, head or face, redirect belt by using the shoulder belt positioner. Thread vehicle shoulder belt through positioner **exactly as shown** ..

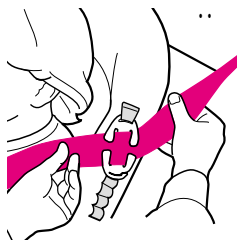

Choose the position that directs belt across the child's chest. NEVER place high end of shoulder belt under child's arm. Use of any shoulder belt in this manner can cause serious injuries or death in the event of a sharp turn, sudden stop or crash.

7. Adjust positioner as high as possible without shoulder belt touching child's neck. To adjust, unhook bottom of positioner, slide up or down to desired height and thread bottom hook into closest loop below ¥ .

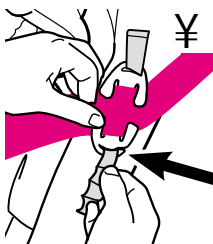

8. Check to be sure shoulder belt is properly positioned over shoulder and snug against child.

Final Safety Checks

9. Make sure that:
- the booster seat and your child are secured with both a lap and shoulder belt, not a lap belt only, **and**
 - vehicle lap belt is NOT TWISTED, and runs across child's thighs and through cutouts on sides of booster seat, **and**
 - vehicle shoulder belt runs across child's chest and belt positioner (if needed) puts the belt in the proper position, **not** across the face or neck.

6.3 Using the Booster Seat in an Airplane

- This Restraint is **not** certified for Aircraft use. Aircraft seat restraints are not equipped with shoulder straps, so it would be impossible to properly secure a larger child in the booster seat on an airplane.





7. Cleaning and Maintenance

- **BLOT THE SEAT COVER** with a damp sponge using a mild soap solution and cool water. If necessary, the cover may be removed and machine washed.
- **CAR SEAT METAL AND PLASTIC PARTS** may be cleaned by wiping with a mild soap and water solution. **DO NOT USE BLEACH.** Use of bleach may weaken plastic parts.
- **HARNESS STRAPS** may be spot cleaned or replaced. **DO NOT IMMERSER THE HARNESS STRAPS IN WATER.** Doing so may weaken the harness straps.
- **BUCKLE** may be cleaned with a damp cloth.
- **NEVER LUBRICATE THE BUCKLE.** If the harness buckle or harness adjuster sticks, check for dropped food or sticky drinks that may have been spilled, dirt, etc. Remove foreign objects with tweezers and/or clean with cotton swab. If

you cannot get the harness to remain tight with the buckle securely locked, do not use this car seat. Call Graco at 1-888-224-6549 to purchase a replacement harness.

● TO REMOVE THE SEAT COVER FOR CLEANING:

1. Remove the ends of the two shoulder straps from the metal junction plate behind the seat.
2. From the front of the seat, pull the strap ends through the slots . **Do not remove the buckles and harness clip from the straps.**
3. Remove elastic loops from around **two** pegs on the **bottom** and **two** pegs on the **top** of car seat.
4. Remove elastic binding from bottom, sides and top of seat as shown .

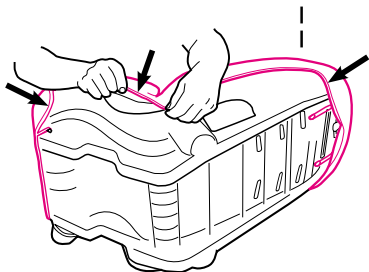
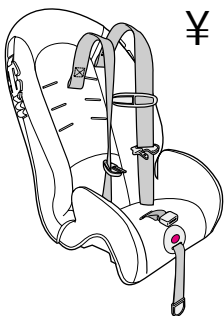

5. Under the front of the seat push in the tab to remove the adjustment button plate § .

§

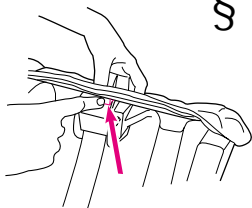

6. Turn adjustment plate sideways and work it through the hole in the seat cover **. **It will be a tight fit so be careful not to tear the seat cover.**

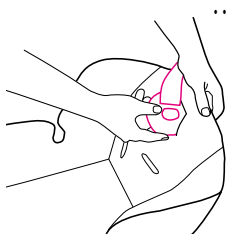

7. Lift cover off seat, pushing harness straps, crotch strap and hardware through slots in cover. **DO NOT USE** car seat without the seat cover.

8. Machine wash cover in cold water on delicate cycle and drip-dry. **DO NOT USE BLEACH.**

9. To put the seat cover back on, reverse the preceding instructions. Push the adjustment plate and strap through the hole in the seat cover. **Be careful not to tear the seat cover.**

10. Insert the two fingers of the adjustment plate into the back of the hole in the seat © .

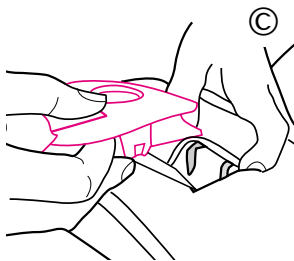

Push the fabric up so that the tab under the adjustment plate is under the cloth ¥ . Snap the adjustment plate back on the seat ¦ . Make sure that the adjustment plate is attached securely to the seat and that the strap moves freely when the button is pushed.

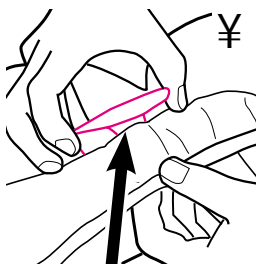

Thread the harness straps through the appropriate holes in the seat cover. See the illustration at right and section 5.1, "Positioning the Harness Straps" (page 15) to properly secure the harness straps back on the seat § .

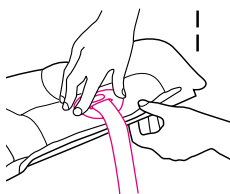

11. Secure the seat cover to the seat by wrapping the elastic binding around **two** pegs on the **bottom** and **two** pegs on the **top** of car seat.

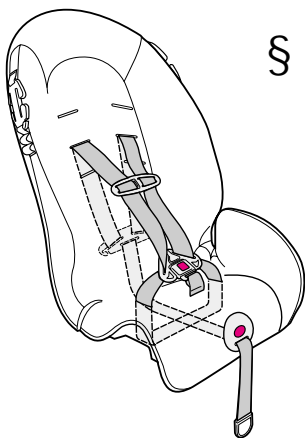

8. Registering Your Car Seat

Model No. _____

Serial No. _____

Purchase Date _____

Dear Customer,

Please fill in the above information. The model and serial numbers can be found on a label underneath your car seat.

Fill out the prepaid registration postcard attached to the seat cover and mail it today. Child restraints could be recalled for safety reasons. You must register this restraint to be reached in a recall. Send your name, address and model/serial numbers to:

Graco Children's Products Inc.

P.O. Box 100

Elverson, PA, 19520-9974

or call 1-888-224-6549.

For recall information, call the U.S. Government's Auto Safety Hotline at 1-800-424-9393 (202-366-0123 in D.C. area).

9. Replacement Parts

Instructions for ordering car seat parts:

Complete the form that follows. Your car seat model and serial numbers **MUST** be included on the form to ensure proper replacement parts. Your model number can be found on a sticker on the underside of your car seat. Payment must accompany your order.

| Parts List: | Price:* |
|--------------------|----------------|
|--------------------|----------------|

| | |
|--------------------|---------|
| Locking clip | \$ 5.00 |
|--------------------|---------|

| | |
|--|----------|
| Harness with buckles and harness clip | \$ 15.00 |
|--|----------|

| | |
|------------------|----------|
| Seat cover | \$ 35.00 |
|------------------|----------|

| | |
|--|---------|
| Crotch strap with buckle and metal retainer | \$ 7.00 |
|--|---------|

| | |
|--------------------|----------|
| Tether strap | \$ 10.00 |
|--------------------|----------|

* Prices subject to
change without notice.

IF YOU NEED HELP

If you have any questions or need any parts not listed, please call toll-free: **1-888-224-6549**
or visit our Internet website,
www.gracobaby.com.

Return the form at right with payment to:
GRACO CHILDREN'S PRODUCTS INC.
CUSTOMER SERVICE DEPARTMENT
P.O. BOX 100, MAIN STREET
ELVERSON, PA 19520

Model No. _____

Serial No. _____

(Both numbers required)

- Locking clip
- Harness with buckles
and harness clip
- Seat cover
- Crotch strap w/buckle
- Tether strap

Subtotal: _____

Shipping
& handling*: _____ \$5.00

Sales tax***: _____

Total: _____

* \$15.00 outside the continental U.S.

**CA 6%, IL 6.25%, IN 5%, NY
8.25%, OH 5.75%, PA 6%, SC 5%

- Check or money order enclosed
(payable to Graco Children's Products Inc.)

- Charge to credit card:

Visa MasterCard Discover

Account #: _____

Expiration date: _____

Signature: _____

SHIP TO:

Name

Address

City, State, Zip

(_____) _____

Telephone

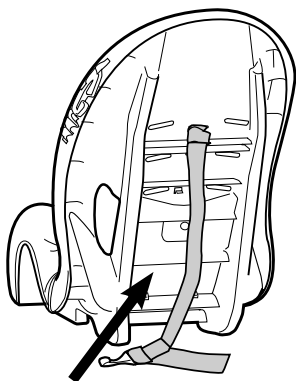

Keep this manual
in the storage compartment
on the back of the car seat.

GRACO[®]

Graco Children's Products Inc.
Elverson, PA 19520
1-888-224-6549