

Combi[®] Select

Instruction Manual

Combi Connection[™] Infant Car Seat

22 lbs. or less
(10 kg o menos)



Combi Connection[™]
8040 Series



Para instrucciones en Español,
llamar al: 1-800-992-6624.

! WARNING !

Correct installation and use can be a matter of Life or Death! Read and understand these instructions before using this car seat.

- Certified for use in motor vehicles and aircraft.
- Meets or exceeds all applicable requirements of Federal Motor Vehicle Safety Standard 213.

Section 1 - Warnings

WARNING

DEATH or SERIOUS INJURY can occur

- Failure to follow these instructions and car seat labels can result in injury or death to a child from striking the vehicle's interior during a sudden stop or crash.
- Use only in a rear-facing position when using this infant car seat in a vehicle. Serious crippling injury or death can result if infant faces front of vehicle.
- Use only with children who weigh 22 pounds (10 kg) or less and whose height is 29 inches (74 cm) or less.
- Discontinue use when infant's weight exceeds 22 pounds (10 kg).
- Snugly adjust harness provided with the car seat around child. Infant **MUST** be secured by harness system at all times, when infant seat is used in vehicle or outside of vehicle.

- **For proper harness fit:**
 - **Infant insert must be used with small infants.**
 - **Shoulder belts MUST be through shoulder belt slots in infant insert.**
 - **Discontinue use of the infant insert when shoulder belts become too short to fit infant.**
- **Secure this child restraint with the vehicle's LATCH System if available or with a vehicle seat belt as shown in this manual.**
- **LATCH System or vehicle seat belt MUST stay tightly adjusted around car seat at all times.**
- **Secure this child restraint to the vehicle, even when not occupied. Unsecured items may injure occupants in a crash.**
- **DO NOT use accessories or parts other than those provided by Combi USA or Strolee. Use of accessories or parts from other manufacturers could alter the performance of the car seat.**
- **DO NOT allow any re-use of this car seat after a crash unless crash and car seat meet ALL conditions in "Re-use After A Crash" section of this manual.**
- **DO NOT use infant car seat if it is damaged, missing instructions, or missing parts.**
- **Register your child restraint with the manufacturer.**

Section 2 - Table of Contents

Section 1. Warnings.....	1	Section 9. Installation of Infant Car Seat In Vehicle (continued)	
Section 2. Table of Contents.....	3	• Securing Base With Vehicle Seat Belt.....	27
Section 3. Connection™ Infant Car Seat Parts.....	5	• Securing Infant Car Seat Without Base.....	31
Section 4. Proper Use Check List.....	7	Section 10. Stroller or Travel System Use.....	36
Section 5. Use Recommendations.....	8	Section 11. Operation and Adjustment	
Section 6. Securing Infant in Car Seat.....	9	• Harness Use and Adjustment.....	37
Section 7. Selecting A Vehicle Seating Location.....	14	• Changing Use Position And Harness Length.....	38
Section 8. LATCH System.....	16	• Carry Handle Operation.....	41
Section 9. Installation of Infant Car Seat In Vehicle.....	18	• Base Adjustment.....	42
• Attachment of Infant Car Seat To Base.....	19	• Egg Shock Foam.....	43
• Securing Base With LATCH System.....	21	• Infant Insert.....	44
		• Canopy.....	45

Section 2 - Table of Contents (continued)

Section 12. Vehicle Seat Belt Systems.....	46
Locking Clip.....	51
Section 13. Additional Information	
• Certification.....	53
• Aircraft Use.....	53
• Warm Weather.....	53
• Vehicle Seat Protection.....	53
• Car Seat Useful Life.....	53
• Instruction Manual Storage.....	53
Section 14. Care and Cleaning.....	54
Section 15. Re-Use After A Crash.....	55
Section 16. Registration Information.....	56
Section 17. Limited Warranty.....	57

Keep this instruction manual for future use.
Store instruction manual inside pouch
located on back of seat pad.

Section 3 - Connection™ Infant Car Seat Parts

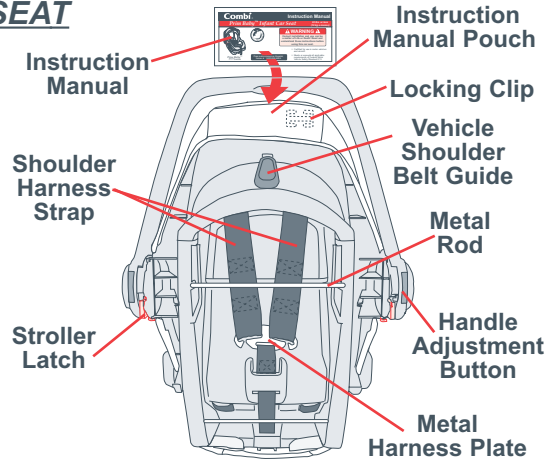
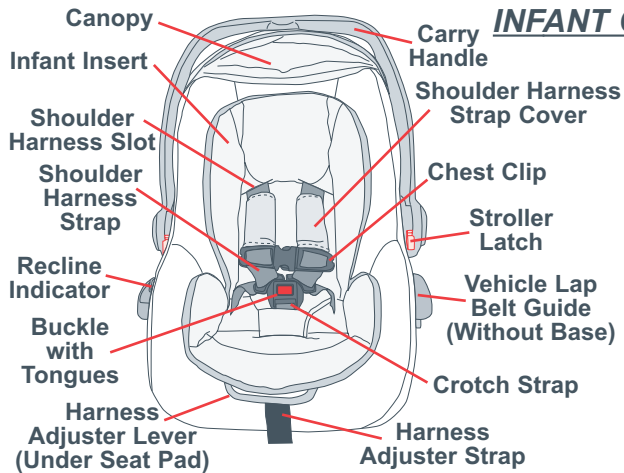

CAR SEAT BASE

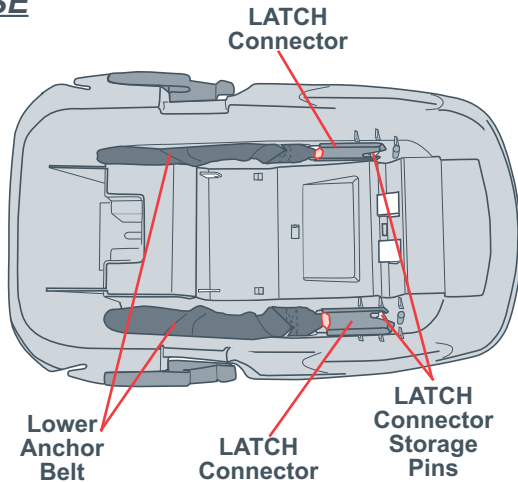
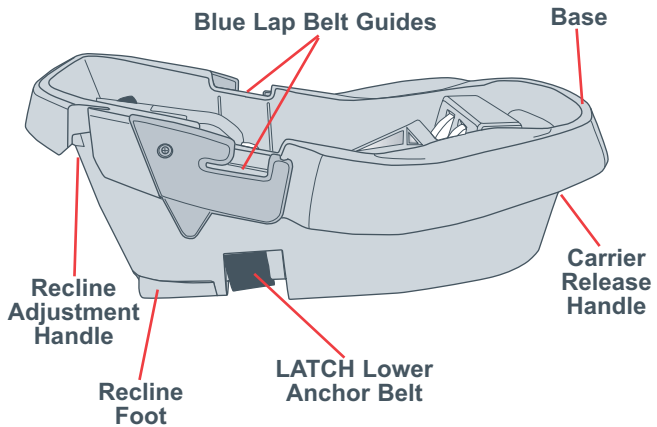

7

Section 4 - Proper Use Check List

- Proper use is required. Read and understand instructions and car seat labels.
- Use this infant car seat rear-facing only.
- Snugly adjust harness straps around child.
- Securely install car seat with LATCH System or vehicle seat belt as specified in this instruction manual.
- Do not use this infant car seat in a front vehicle seating location with an air bag.
- Secure children in back seat whenever possible.
- Never leave child unattended.
- Do not allow anyone (babysitter, relatives, etc.) to use car seat without first reading and understanding all instructions and car seat labels.

Need help installing your infant car seat?

Contact one of the following sources:

- Your vehicle dealer to locate a child safety seat inspection station in your area.
- Call 1-866-SEAT CHECK (1-866-732-8243).
- Visit www.nhtsa.dot.gov and select "Child Seat Inspections".
- Visit www.seatcheck.org.
- Contact a certified child passenger safety technician in your area. To locate a certified "Child Passenger Safety" Technician in your area visit www.nhtsa.dot.gov and select "Child Passenger Safety" and then select "Technician Contact Locator".

Proper Use Is Required:

No car seat can guarantee protection from injury in every situation, but proper use helps reduce the risk of serious injury or death.

Section 5 - Use Recommendations

Height and Weight Limits:

This infant car seat is designed for rear-facing use only.

Use this car seat for infants whose:

- Weight is 22 pounds (10 kg) or less and
- Height is 29 inches (74 cm) or less.



Infants With Special Needs

A preterm infant or low birth weight infant may be at special risk traveling reclined in a vehicle or aircraft. According to the American Academy of Pediatrics, these infants may be at increased risk of suffering breathing or other difficulties if improperly reclined or positioned in a car seat.

Have your physician or hospital staff evaluate your infant in this car seat before you and your infant leave the hospital. If your infant is not able to travel in a reclined position, DO NOT use this car seat. Use a car bed for your infant.

Section 6 - Securing Infant In Car Seat

WARNING

DEATH or SERIOUS INJURY can occur

- **Keep harness straps snug and positioned on shoulders and thighs. Infant MUST be secured by harness system at all times, when infant seat is used in vehicle or outside of vehicle.**
- **For proper harness fit:**
 - **Infant insert must be used with small infants.**
 - **Shoulder belts MUST be through shoulder belt slots in infant insert.**
 - **Discontinue use of the infant insert when shoulder belts become too short to fit infant.**
- **Egg Shock foam MUST be used at all times:**
 - **When using infant insert, Egg Shock foam MUST be inside pocket on back of infant insert.**
 - **When infant insert is not used, Egg Shock foam MUST be inside pocket on back of seat pad.**

- **Discontinue the use of the infant insert when:**
 - **Shoulder belts become too short to fit infant.**
- **Child must be dressed in clothing with arms and legs that will not interfere with buckling, snugly adjusting or positioning harness.**
- **Never leave child unattended, even when sleeping.**
- **Suffocation Hazard: Infant car seat can roll over on soft surfaces and suffocate child. Never place infant car seat on beds, sofas or other soft surfaces.**
- **Strangulation Hazard: Child can strangle in loose harness straps. Never leave child in an infant car seat when straps are loose or undone.**
- **Fall Hazard: Child's movement can slide infant car seat. Never place infant car seat near edges of countertops, tables or other elevated surfaces.**

11

Positioning of shoulder harness and infant insert to fit infant's size:

Check positioning of shoulder harness through seat back when first using the car seat and periodically after that to verify correct fit and positioning of the harness for infant's size.

Shoulder harness straps *MUST* be through:

- Shoulder harness slots *at or just below* infant's shoulders.
- Shoulder harness slots in infant insert.

See "Operation and Adjustment" section to change position of harness.

NOTE: Infant insert *MUST* always be used with small infants (**fig. a & b**).

Egg shock foam *MUST* be used at all times.

- When using infant insert, Egg Shock Foam *MUST* be inside pocket on back of insert (see "Egg Shock Foam" section).
- When infant insert is *NOT* used, Egg Shock Foam *MUST* be inside pocket on back of seat pad.

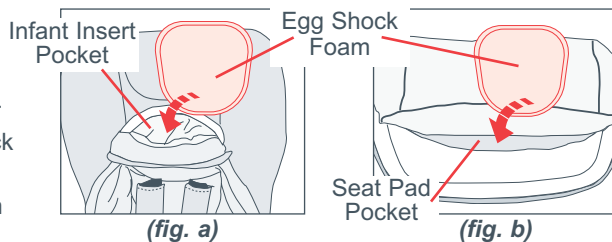

Securing infant in car seat:

- 1** Loosen harness - Insert finger under adjuster cover, press on harness adjustment lever, and pull harness straps out (**fig. a**).
- 2** Unbuckle harness - Press red release button on buckle and pull tongues out of buckle.
- 3** Place infant in car seat with back and rump contacting seating surfaces.
- 4** Place harness straps over child's shoulders and thighs.
- 5** Insert buckle tongues into buckle (**fig. b**). You should hear a click.
- 6** Pull up on tongues to be sure they are locked.

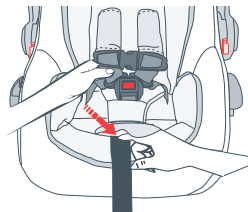

(fig. a)



(fig. b)

13

- 7** Pull harness adjuster strap (**fig. c**) to snugly adjust harness straps onto child.
- Check that harness straps are snug on shoulder and thighs. Straps should not allow a finger to pass between the belt and the child's shoulder.
 - A snug harness strap should not allow any slack. It lies in a relatively straight line without sagging. It does not press on the child's flesh or push the child's body into an unnatural position.

NOTE: If harness can not be snugly adjusted as described above:
- See "Harness Use and Adjustment" section.

- 8** Close chest clip and position chest clip at arm pit level (**fig. d**).

Small infants:

For a small infant, a rolled towel can be used on each side for support (**fig. d**). Towels **MUST** not interfere with the ability to snugly adjust the harness system. **DO NOT** place towel or other items behind infant or between infant and harness.

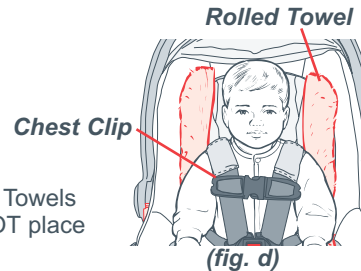
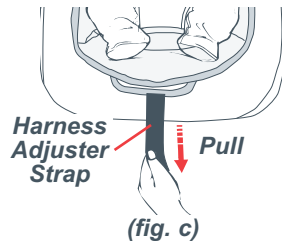

Section 7 - Selecting A Vehicle Seating Location

- 1 The National Highway Traffic Safety Administration (NHTSA) alerts vehicle owners that according to accident statistics, children up to age 12 are safer when properly restrained in rear seating positions rather than front seating positions.
- 2 Refer to vehicle owner's manual for car seat installation instructions for your vehicle.
 - Use car seat in a rear vehicle seat location whenever possible.
 - Never put a car seat in a front seat location unless recommended by vehicle owner's manual.
 - For vehicles with air bags, always follow child restraint installation information provided in vehicle owner's manual.
- 3 **DO NOT** use car seat on vehicle seats which face the side (*fig. a*) or face the rear (*fig. b*) of the vehicle.

	<p>DO NOT place rear-facing child seat on front seat with air bag. DEATH OR SERIOUS INJURY can occur.</p> <p>The back seat is the safest place for children 12 and under.</p>	WARNING
<p>NO coloque el asiento infantil para el automóvil orientado hacia atrás en el asiento delantero del vehículo que tenga una bolsa neumática de seguridad. El niño podría MORIR O SUFRIR LESIONES GRAVES. El asiento trasero es el lugar más seguro para los niños de 12 años o menores.</p>		



(fig. a)



(fig. b)

Options For Securing A Car Seat:

This infant car seat can be secured to a vehicle using the LATCH system or a vehicle seat belt.

1. LATCH System:

LATCH stands for **L**ower **A**nchorage and **T**ether for **C**hildren.

The LATCH System can be used when securing the car seat with the base.

Starting with model year 2003, all vehicles are equipped with LATCH Systems. See “LATCH System” section for more information. Check vehicle owner’s manual to determine if your vehicle has the LATCH System that may be identified with the symbol in fig. c.

Some vehicle owner’s manuals may identify the LATCH System as “ISOFIX”. An ISOFIX System can be used in the same way as the LATCH System.

If your vehicle has the LATCH System, the LATCH System should be used whenever possible.

2. Vehicle Seat Belt:

The car seat with the base or without the base can be secured using vehicle seat belts.

If your vehicle does not have the LATCH System, the car seat **MUST** be secured to the vehicle using a vehicle seat belt.

Check vehicle owner’s manual for seating locations recommended for car seat use.



(fig. c)

Section 8 - LATCH System

LATCH System On This Car Seat:

The LATCH System on the Prim Baby™ Car Seat consists of a lower anchor belt ① with lower anchor connectors ②.

The lower anchor connectors ② on the car seat connect to the LATCH System in a vehicle.

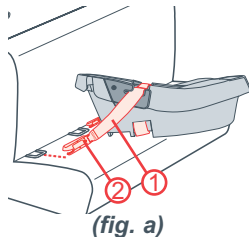

LATCH System On Vehicles:

Child restraint anchorage system (LATCH) in the vehicle consists of two lower anchorages ③ located at the vehicle seat bight ④ and a top tether anchorage ⑤ (fig. b). Refer to vehicle owner's manual for seating locations which have the LATCH System.

The Prim Baby™ uses the lower anchor anchorages but does not use the top tether.

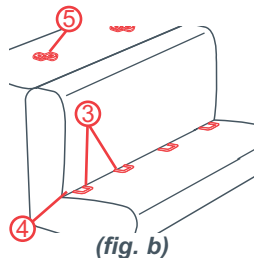

17

Lower anchorages are visible in some vehicles and not in others.

Those that are not visible are identified by a marker placed just above the anchorage on the seat back. This marker can be a solid color round dot as shown in **fig. c**.

The vehicle manufacturer may provide funnel guides to separate the vehicle seat cushions providing easier access to the lower anchorage. See vehicle owner's manual.



(fig. c)

Section 9 - Installation of Infant Car Seat in Vehicle

**WARNING****DEATH or SERIOUS INJURY can occur**

- Use only in a rear-facing position when using this infant car seat in a vehicle.
- Secure this child restraint with the LATCH System or a vehicle seat belt as shown in this manual.
- LATCH belt or vehicle seat belt must stay tightly adjusted around car seat or base at all times. If LATCH belt or vehicle seat belt does not stay tight, read the vehicle owner's manual and "Vehicle Seat Belts" section in this manual.
- Rear-facing car seat must be properly reclined:
 - Too reclined can result in injury or ejection.
 - Too upright can result in breathing difficulties.
- After installing infant car seat in base, lift car seat to be sure it is securely locked.

Attachment Of Infant Car Seat To Base:

Removal Of Infant Car Seat From Base:

- 1** Pull orange release lever **①** and lift car seat from base **②** (*fig. a*).

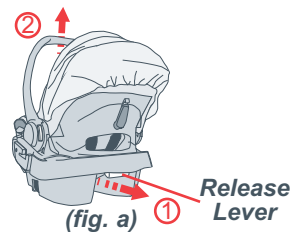

Attaching Infant Car Seat To Base:

- 1** Verify that there are no objects on top of base or between base and infant car seat that will prevent proper latching of car seat.
 - Verify lower anchor belt is routed or stored properly.
- 2** With child facing the rear of the vehicle, lower car seat into base and push down on car seat to lock car seat into base (*fig. b*).
- 3** Test to be sure car seat is locked in base. Lift on car seat at top of seat back **①** (*fig. c*) and at child's feet **②**.

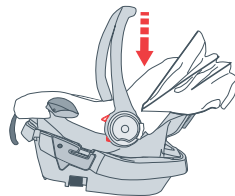

(fig. b)

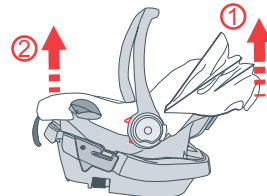

(fig. c)

- 4 Carry handle should be kept in the carry position (see “Carry Handle Operation” section).
- 5 Adjust recline using recline indicator on the side of car seat. Line on recline indicator **MUST** be in green striped zone (**fig. d**).

If line is not in green striped zone, adjust base using the recline foot (see “Base Adjustment” section), and recheck recline of car seat. Repeat until recline indicator is in green striped zone.

If base can not be adjusted to locate the line in the green striped zone:

1. Try a different seating position.
2. Do not use this infant car seat.

NOTE: Vehicle must be parked on flat, level surface during this installation.

- 6 Verify that LATCH belt or vehicle seat belt is still tightly adjusted around base.

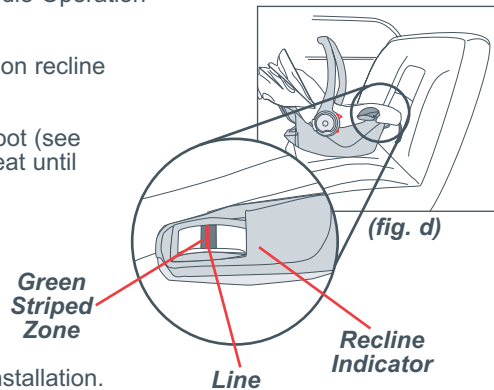

Securing Base With LATCH System:

! WARNING !

DEATH or SERIOUS INJURY can occur

- **Only use the car seat LATCH System in vehicle seating locations recommended by the vehicle manufacturer for use with LATCH and that have an anchor spacing of 280 mm (11 inches).**
- **LATCH connectors must be secured to the vehicle LATCH anchorages only. Connection to other vehicle components could result in the anchor tearing free in a crash.**
- **Never attach more than one anchor connector to a vehicle lower anchorage unless recommended by the vehicle owner's manual for that vehicle.**

- 1** Refer to vehicle owner's manual to identify the seating locations with LATCH System. Select the seating location to be used and locate the vehicle lower anchorages at the seat bight.

A LATCH Anchorage System with 280 mm (11 inch) spacing may not be available in your vehicle in the rear center seating position. If use of the rear center position is preferred, use the vehicle seat belt to secure the car seat. See "Securing Base With Vehicle Seat Belt" section.

- 2** If vehicle seat back is adjustable, adjust vehicle seat back into most upright position.
- 3** Remove car seat from base.
- 4** Lift the LATCH lower anchor connectors out of the base (*fig. a*).
- 5** Lengthen lower anchor belt. While pressing adjuster release button, pull belt to extend the length of lower anchor belt (*fig. b*).
- 6** Place lower anchor belt over side of base and into belt slot in vehicle lap belt guide (*fig. c*).
Repeat for opposite side.
- 7** Check that the belts are not twisted.

**LATCH Lower
Anchor Connectors**

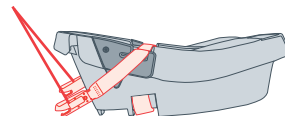

(fig. a)

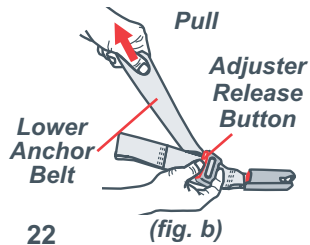

22

(fig. b)

**Vehicle Lap
Belt Slot**

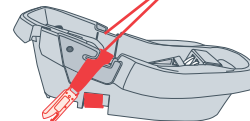

(fig. c)

23

- 7** Place base rear-facing in the vehicle seat location selected with blue lap belt guides toward vehicle seat back and centered between the vehicle lower anchors (**fig. d**).

Attach car seat to base.

- 8** Adjust recline using recline indicator on the side of the car seat. Line of recline indicator **MUST** be in green striped zone (**fig. e**). If line is not in green striped zone, adjust base using recline foot (see “Base Adjustment” section), and recheck recline of car seat. Repeat until recline indicator is in green striped zone.

If base can not be adjusted to locate the line in the green striped zone:

1. If necessary, place tightly rolled towel, pool noodle, or firm object under recline foot to level car seat.
2. Try a different seating position.
3. Do not use this infant car seat.

NOTE: Vehicle must be parked on horizontal surface during this installation.

- 9** Remove car seat from base.

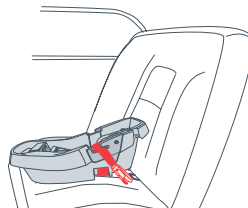

(fig. d)

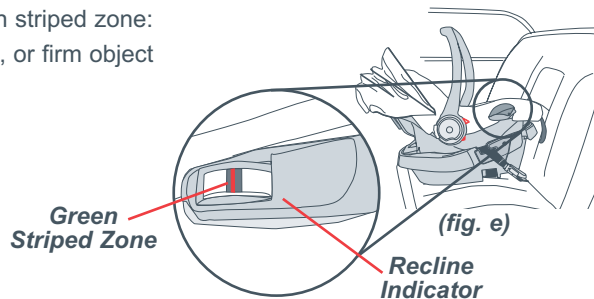

(fig. e)

Green Striped Zone

Recline Indicator

- 10** Connect lower anchor connectors to vehicle lower anchors:
- Position red release button of push-on connector facing away from base and wording on back side of connector facing base. If connector is not in this position, turn connector over.
 - Position the slot of the push-on connector over the vehicle anchorage. Push connector in to lock onto the vehicle anchorage (**fig. f**). You should hear a click.
 - Pull on connector to be sure it is locked onto the anchorage.
 - Repeat for connector on opposite side.

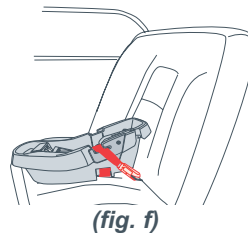

- 11** Tighten lower anchorage belt to secure the base. Press down in center of base to depress the vehicle cushion and pull free end of lower anchor belt to tighten belt around base (**fig. g**).

Check for secure installation. Pull base front to back and left to right to check for secure installation (**fig. h**). LATCH belt MUST stay tight.

If LATCH belt does not stay tight or base can not be securely installed, try a different LATCH location or use the vehicle's seat belt to secure the base.

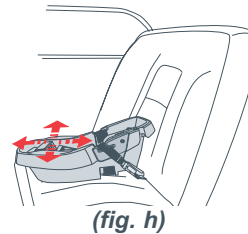
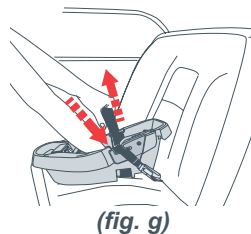

25

- 12 Attach car seat to base.
- 13 Recheck recline of car seat. Adjust if necessary (see step 8).

Removal Of Base Installed With LATCH:

- 1 Loosen lower anchor belt:
 - While pressing down in center of base to reduce tension on lower anchorage belt, push adjuster release button and loosen belt.
- 2 Remove lower anchor connector:
 - Press and hold the red release button.
 - Pull the connector off the vehicle anchorage bar (**fig. a**).
- 3 Repeat to remove connector on opposite side.

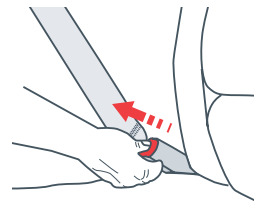

(fig. a)

Storage Of Lower Anchorage Belt And Lower Anchor Connectors:

When not using the LATCH System, store the anchor belt adjuster and lower anchor connectors by placing the connectors over the pins inside base and folding belts into the recessed areas of the base **(fig. a)**.

- Belts and lower anchor connectors *MUST* be properly stored in base to allow secure attachment of car seat to base.

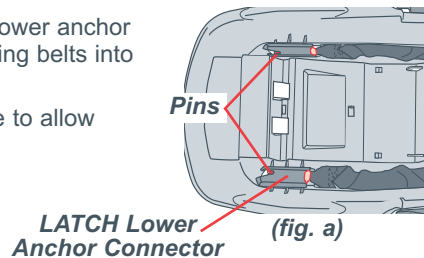

Securing Base With Vehicle Seat Belt:

⚠ WARNING ⚠ DEATH or SERIOUS INJURY can occur

- Not all vehicle seat belts can be used with a car seat. Read vehicle owner's manual and "Vehicle Seat Belts" section in this manual.

- 1 Refer to vehicle owner's manual to identify the seating locations which can be used with a car seat. Check for specific instructions for car seat use.
- 2 After selecting a seating location, if vehicle seat back is adjustable, adjust vehicle seat back into most upright position.
- 3 Place base with car seat attached rear-facing on vehicle seat with blue lap belt guides toward vehicle seat back (*fig. a*).



(fig. a)

- 4** Adjust recline of car seat. Line inside recline indicator on side of car seat **MUST** be in green striped zone (**fig. b**). If line is not in green striped zone, adjust base (see “Base Adjustment” section), and recheck recline of car seat. Repeat until recline indicator is in the green striped zone.

If base can not be adjusted to locate the line in the green striped zone:

1. If necessary, place tightly rolled towel, pool noodle, or firm object under recline foot to level car seat.
2. Try a different seating position.
3. Do not use this infant car seat.

NOTE: Vehicle must be parked on horizontal surface during this installation.

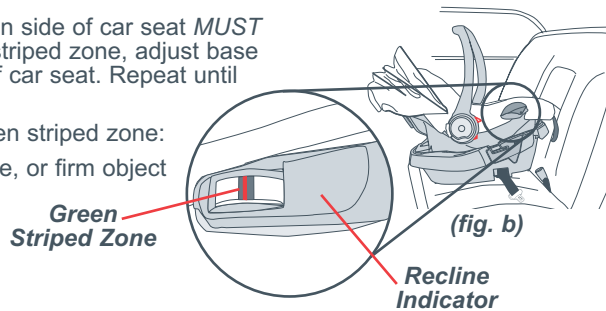

- 5** Remove car seat from base.

6 Route vehicle lap belt through base.

- a. Starting on side of base where lap belt is attached to vehicle, route belt up over outside of blue belt guide **①**, into belt slot, down the outside of the base and across the bottom of the base to the opposite side **②** (**fig. c**).
- b. On opposite side of car seat, thread vehicle lap belt up between base **③** and blue belt guide and place lap belt into belt slot on blue belt guide and down over outside of blue belt guide **④** (**fig. d**).
- c. Buckle belt.
- d. Check that vehicle lap belt is not twisted and lays flat across bottom of base.

NOTE: When installing with a lap and shoulder belt, route only the lap belt through the base, DO NOT route the shoulder belt through base.

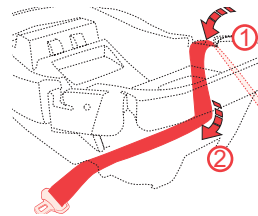
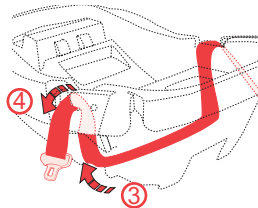
**(fig. c)****(fig. d)**

- 7** Tighten vehicle belt to secure the base. Press down in center of base to depress the vehicle cushion while tightening vehicle belt (**fig. e & f**).
- When using a vehicle lap and shoulder belt, after tightening lap portion of the belt, place shoulder belt into slot in corner of base and allow shoulder belt to rest against vehicle seat back (**fig. g**).

- 8** Check for secure installation. Pull base front to back and left to right to check for secure installation (**fig. h**). Vehicle lap belt **MUST** stay tight.

- 9** If the vehicle lap belt does not stay tight or base cannot be securely installed, see vehicle owner's manual, "Vehicle Seat Belts" section or move to a different seating location.

- 10** Attach car seat to base. Lift car seat to ensure it is properly attached to the base (see "Attachment Of Car Seat To Base" section).

- 11** Recheck recline of car seat. Adjust if necessary (see step 4).

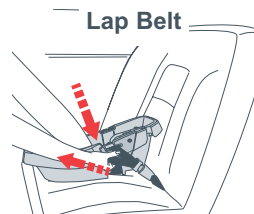

(fig. e)

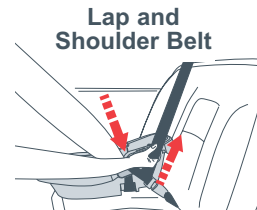

(fig. f)

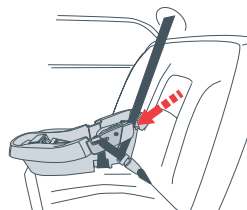

(fig. g)

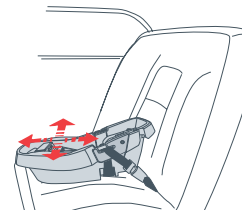

(fig. h)

Securing Infant Car Seat Without Base:



WARNING

DEATH or SERIOUS INJURY can occur

- **Not all vehicle seat belts can be used with a car seat. Read vehicle owner's manual and "Vehicle Seat Belts" section in this manual.**

Installation with Lap Belt Only:

- 1** Refer to vehicle owner's manual to identify the seating locations which can be used with a car seat. Check for specific instructions for car seat use.
- 2** After selecting a seating location, if vehicle seat back is adjustable, adjust vehicle seat back into most upright position.
- 3** Place car seat rear-facing on vehicle seat.
- 4** Thread vehicle lap belt through vehicle lap belt guides on car seat (**fig. a**) and buckle vehicle belt. Be sure vehicle lap belt is not twisted.

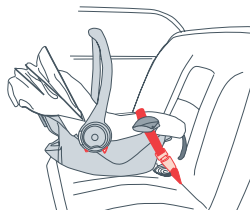

(fig. a)

- 5 Press down firmly on car seat to compress vehicle seat cushion while tightening vehicle lap belt (**fig. b**).
- 6 Adjust recline using the recline indicator on the side of car seat (**fig. c**). Line on recline indicator must be in green striped zone.

If line is not in green striped zone, place a tightly rolled up towel, blanket or firm foam (pool noodle) under end of car seat contacting vehicle seat back.

If car seat can not be adjusted to locate the line in the green striped zone:

1. Try a different seating position.
2. Do not use this infant car seat.

NOTE: Vehicle must be parked on horizontal surface during this installation.

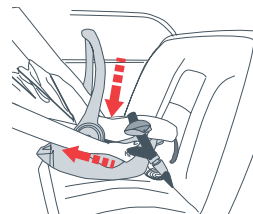

(fig. b)

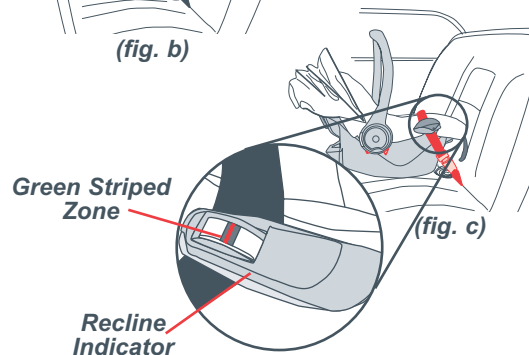

(fig. c)

33

- 7** Check for secure installation. Pull front to back and left to right to check for secure installation (**fig. d**). Vehicle lap belt **MUST** stay tight.
If vehicle lap belt does not stay tight, see “Installation with Lap/Shoulder Belts” below.
- 8** Recheck car seat recline. Verify line is in green striped zone of recline indicator.
- 9** Carry handle should be kept in the carry position, (see “Carry Handle Operation” section).

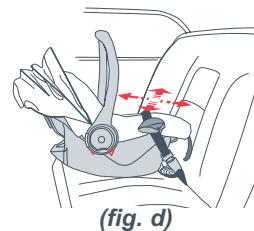

Installation with Lap And Shoulder Belts:

- When using vehicle lap and shoulder belts, shoulder belt may be used for additional support. Place shoulder belt around back of Combi Connection™ (**fig. e**) and through the vehicle shoulder belt guide on back of car seat shell (**fig. f**). If shoulder belt is too short to go around back of Combi Connection™, position shoulder belt against vehicle seat back (**fig. g**). Do not route shoulder belt through lap belt guides on either side of car seat.
- Lap/shoulder belt with free sliding latch plate:
 - Pull out on latch plate (**fig. h**). If belt slides freely through latch plate, a locking clip must be used as described in “Locking Clip” section.
 - Some combination lap/shoulder belts with free sliding latch plates may be converted into an “automatic locking mode” that will allow use without a locking clip. See vehicle owner’s manual and label on vehicle belts for instructions.

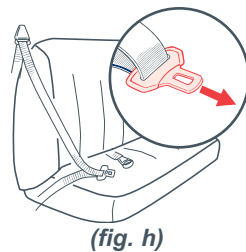
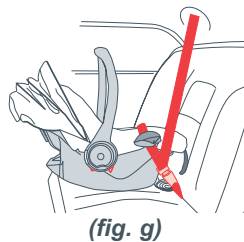
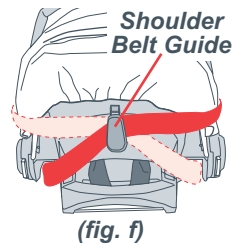
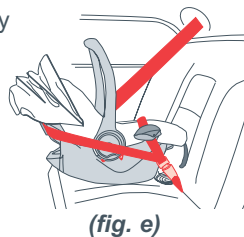

Removal Of Infant Car Seat From Vehicle:

- 1** Unhook shoulder belt from behind car seat and unbuckle vehicle seat belt.
- 2** Remove lap belt from vehicle lap belt guides.
- 3** Remove car seat from vehicle.

Section 10 - Stroller or Travel System Use

This infant car seat can only be used with certain Combi stroller models to transport your infant.

Check Combi stroller information or the Combi USA, Inc. website at www.combi-intl.com, for an updated list of stroller models that will work with your Combi connection Infant Car Seat.

See stroller instructions for securing car seat and use information.



WARNING

DEATH or SERIOUS INJURY can occur

- Infant car seat **MUST** be secured to stroller. After installation, lift car seat to verify it is securely locked onto stroller.
- Stroller latch is for releasing car seat from stroller. Stroller latch automatically locks to stroller. **NEVER** push down on stroller latch. Stroller latch could be damaged.

Section 11 - Operation and Adjustment

Harness Use and Adjustment

Harness Strap Adjustment:

- To tighten: Pull front adjuster strap (**fig. a**).
- To loosen: Insert finger under adjuster cover on pad, press harness adjuster lever, and pull harness straps out.
- If the harness cannot be adjusted to properly fit child, (see “Changing Harness Length And Use Position” section).

Chest Clip Operation:

- To open: Press tabs ① and pull apart ② (**fig. b**).
- To close: Snap halves together. Make sure chest clip is locked by pulling out.

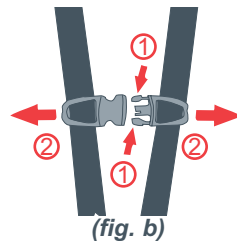
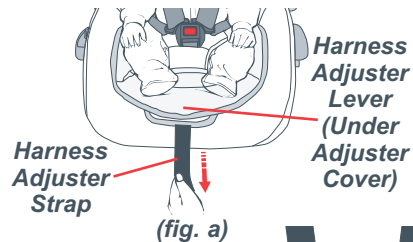

Changing Use Position and Harness Length

! WARNING !

- Shoulder belts **MUST** be through belt slots in infant insert.
- Shoulder harness **MUST** snugly adjust around infant.
- Shoulder harness straps **MUST** be through slots *at or just below* shoulders.

Each shoulder harness strap has two harness adjustment loops, ① and ②, to adjust harness fit as the infant grows.

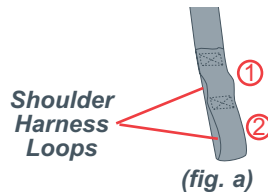

Changing Shoulder Harness Length:

1. Buckle harness and chest clip.
2. From front of car seat, loosen harness straps by pressing harness adjuster lever, ③, and pulling harness straps out, ④ (*fig. d*).
3. From back of car seat, remove both harness adjustment loops from metal harness plate (*fig. e*).
4. To lengthen shoulder harness:
 - Re-attach metal harness plate in lower adjustment loops on shoulder harness straps (*fig. f*).
- To shorten shoulder harness:
 - Re-attach metal harness plate in upper adjustment loops on shoulder harness straps.
5. Check that loops are completely in slots of metal harness plate, and under tabs on both sides (*fig. f*).

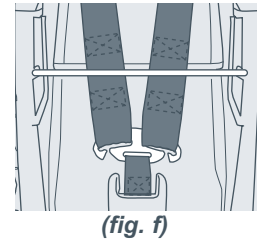
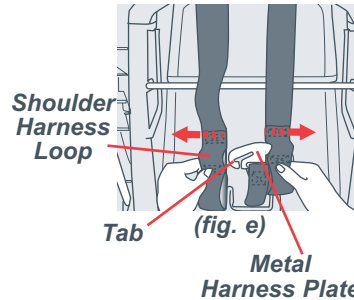
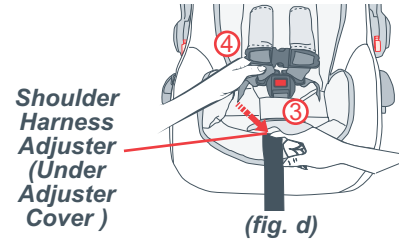

Changing Shoulder Harness Slot Position:

1. Buckle Harness and chest clip.
2. Loosen harness straps, (see “Harness Use And Adjustment” section).
3. From back of car seat unhook both harness loops from metal harness plate (**fig. b**).
4. From front of car seat, pull harness straps out through infant insert, seat pad, and car seat shell.
5. From front of car seat, rethread harness straps through infant insert, desired harness strap slots of seat pad, and seat back.

Make sure harness straps are not twisted and are threaded through matching slot of infant insert, seat pad and seat back.

6. From back of car seat, route shoulder straps between plastic seat and metal rod, then re-attach harness adjustment loops to metal harness plate (**fig. c**).

Check that loops are completely in slots of metal harness plate and under tabs on both sides.

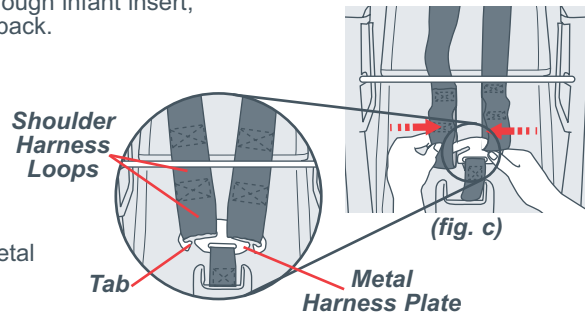
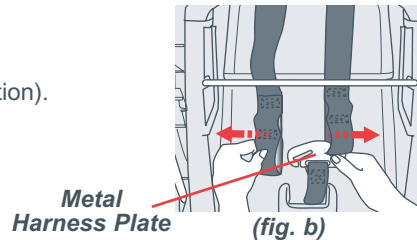

Carry Handle Operation - Carry handle has four positions (fig. c):

- A. Vehicle use position and carrying position**
- B. Rocking position**
- C. Rocking position**
- D. Reclined seat position**

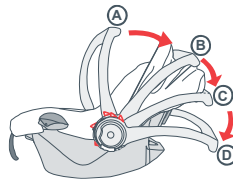

(fig. c)

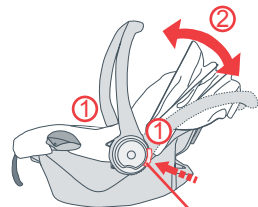

(fig. d)

**Handle
Adjustment
Button**

To change carrying handle position:

- Push in handle adjustment buttons on each side of handle ① (fig. d).
- Rotate handle forward or backward ② until it locks into a use position.

IMPORTANT: Check to be sure carry handle is locked before lifting car seat.

NOTE: Handle does not lock between position C and position B. Handle will move from position C into position B without pushing in handle adjustment buttons.

Base Adjustment:

⚠ WARNING ⚠ DEATH or SERIOUS INJURY can occur

- Rear-facing car seat **MUST** be properly reclined:
 - Too reclined can result in injury or death from ejection.
 - Too upright can result in breathing difficulties.

The base has a three position adjustable recline foot to assist in properly reclining the car seat.

Use recline indicator to verify proper car seat recline position.

To Adjust:

- Pull out on orange recline adjuster handle and lower or raise recline foot to desired position (**fig. a**).
- Release recline adjuster handle to lock recline foot in position.

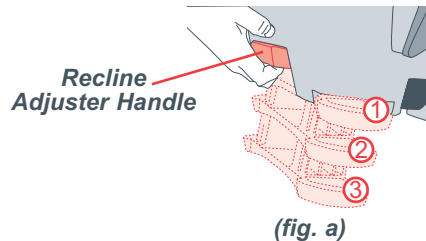

Egg Shock Foam:

⚠ WARNING ⚠

- Egg Shock foam **MUST** be used at all times, with or without infant insert.

There are two different locations for placement of the energy absorbing Egg Shock Foam according to use of infant insert.

Egg Shock foam **MUST** be used at all times:

- When using infant insert, Egg Shock foam **MUST** be inside pocket on back of infant insert (**fig. a**).
- When infant insert is not used, Egg Shock foam **MUST** be inside pocket on back of seat pad (**fig. b**).

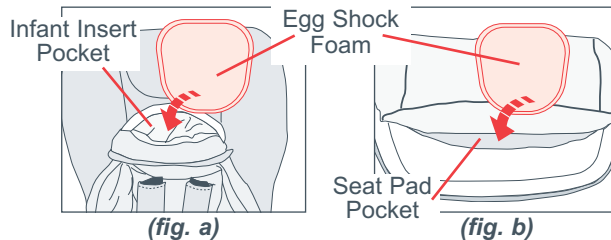

Infant Insert:

⚠ WARNING ⚠

- **To prevent ejection:**
 - **Shoulder belts MUST be through belt slots in infant insert.**
 - **For proper harness fit, infant insert MUST be used for small infants.**
- **Discontinue use of infant insert when:**
 - **Shoulder belts become too short to fit infant.**
- **Egg Shock foam MUST be used with infant insert:**
 - **Place Egg Shock foam inside pocket on back of infant insert.**
- **Foam pad MUST be inside infant insert at all times.**

To clean infant insert:

- Remove infant insert from car seat.
- Remove Egg Shock foam and foam pad from infant insert.
- Launder infant insert - wash separately in cold water, delicate cycle, no bleach and drip dry.
- Reinsert foam pad and Egg Shock foam.

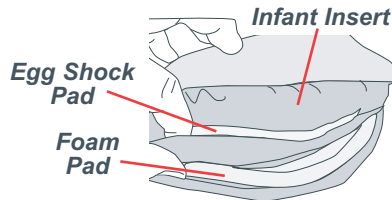

- **Canopy:**

Secure snaps on side of canopy to seat pad, hook canopy over back of car seat and pull canopy forward (**fig. a**).

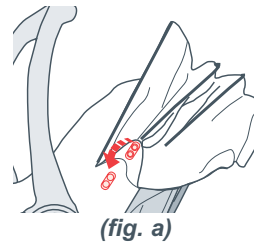

Section 12 - Vehicle Seat Belt Systems

Design and operation of vehicle seat belt systems vary from vehicle to vehicle and from seating location to seating location in the same vehicle. Not all vehicle seat belts can be used with a child restraint. Refer to the information in this section for information on the various types of vehicle seat belt systems.



WARNING

DEATH or SERIOUS INJURY can occur

- **Not all vehicle seat belts can be used with a car seat. Read vehicle owner's manual and "Vehicle Seat Belts" section in this manual.**

To provide a secure installation of the car seat:

- Read the vehicle owner's manual regarding car seat installation and vehicle seat belt use with car seat.
- Follow all instruction labels on vehicle seat belt and car seat.

If car seat does not stay tightly secured after following instructions in this manual, vehicle seat belt labels, and vehicle owner's manual:

- Move car seat to another seating location and try again, or
- Contact vehicle dealer for assistance and possible seat belt modification parts.
- Obtain assistance, see "Need Help Installing Your Car Seat" in "Proper Use Checklist" section.

Belts Forward of Seat Bight

Vehicle seat belts located forward of seat bight (**fig. a & b**) may not securely hold car seat. Check vehicle owner's manual or see vehicle dealer for car seat installation requirements.

- *If seating position is approved for use with car seat, install car seat and check for secure installation by pulling car seat front to back. If car seat slides forward or vehicle seat belt does not stay tight, DO NOT use these seat belts.*

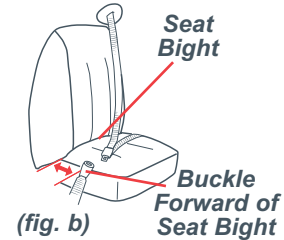
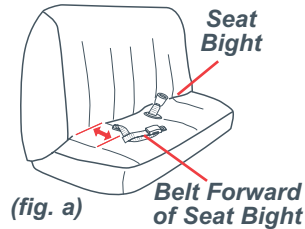

Lap Belts - Manually Adjustable

Manually adjustable lap belts (**fig. c**) normally will hold a car seat tightly. However, in some cases, the locking latch plate on some seat belts may slip and loosen if positioned at a certain angle. If this happens, flip latch plate over (**fig. c**) and re-buckle. Test installation again to see if lap belt stays tight. If not, move car seat to another seating location.

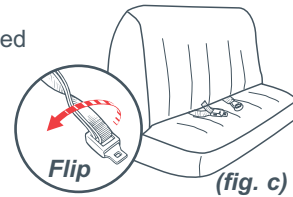

Lap Belts - With Retractor

Lap belts with retractors (**fig. d**) may or may not hold a car seat securely.

Follow these steps to determine if you have a retractor system that will hold car seat securely:

- a. Pull belt all the way out.
- b. Allow belt to retract about 6 inches (15 cm).
- c. Pull out on belt again.

If belt is locked and you cannot pull the belt out any further, you have an Automatic Locking Retractor which may be used with a car seat. Remember, when installing a car seat, pull belt all the way out, buckle belt, and then tighten.

If the belt pulls out (step c), the retractor is an Emergency Locking Retractor which must not be used with a car seat.

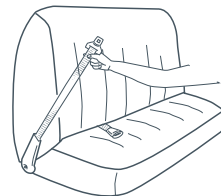

(fig. d)

Passive Restraints

Lap Belt with Motorized Shoulder Belt (fig. e)

DO NOT use with any car seat.

- See your vehicle dealer for available hardware or options for securing a child restraint in this location.

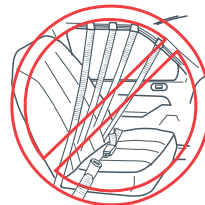

(fig. e)

Lap or Shoulder Belt Mounted on Front Door (fig. f)

DO NOT use a car seat in any front seating location that has belts mounted to the front door. Belts will not stay tight while driving.

- See your vehicle dealer for available hardware or options for securing a child restraint in this location.

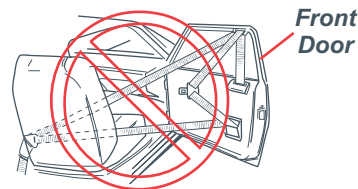

(fig. f)

Combination Lap/Shoulder Belt with Free Sliding Latch Plate

Pull out on latch plate. If belt slides freely through latch plate (**fig. g**), the locking clip MUST be used (see “Locking Clip” section).

- For rear-facing, use the locking clip to secure the lap belt (see “Locking Clip” section).
- For forward-facing, use the locking clip to secure the lap/shoulder belt.

Some combination lap/shoulder belts with free sliding latch plates may be converted into an “automatic locking mode”. Always use the belt lock-off with these belt systems.

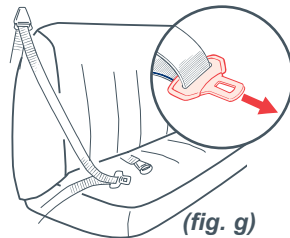

Combination Lap/Shoulder Belt with Locking Latch Plate

Vehicle seat belts with locking latch plates (**fig. h**) normally hold a car seat tightly. However in some cases, the locking latch plate on some seat belts may slip and loosen after being buckled on car seat if positioned at a certain angle. If this happens, flip the latch plate over and re-buckle. Test installation again to see if this works. If not, move car seat to another seating location.

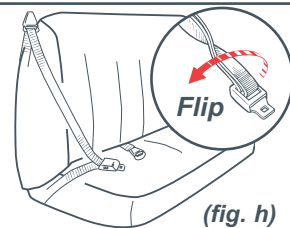

Section 12 - Vehicle Seat Belt Systems

Locking Clip (stored in pouch on back of car seat):

You **MUST** use locking clip provided with this car seat with a vehicle belt that slides freely through the latch plate or if the lap portion of the lap/shoulder belt cannot be tightly secured.

**WARNING****DEATH or SERIOUS INJURY can occur**

Avoid serious injury or death:

- Failure to use locking clip where required will result in car seat not being securely held in place.
- Remove locking clip from vehicle seat belts when not being used with car seat.
- **DO NOT** use locking clip as a vehicle seat belt shortener.

- 1** Install car seat or base rear-facing on vehicle seat and tighten vehicle seat belts.

- 2** While holding vehicle seat belts together at latch plate (**fig. a**), unbuckle belt.
- 3** Slide vehicle belt out of vehicle lap belt guide on the side of the seat or base which the buckle is on.
- 4** Slide locking clip onto vehicle seat belts approximately 1/2 inch (1 cm) away from latch plate (**fig. b**).
- 5** Slide vehicle belt back into vehicle lap belt guide.
 - Check to be sure vehicle lap belt is still correctly routed throughout entire belt path.

- 6** Re-buckle vehicle seat belt.
- 7** Test installation to see if car seat or base is secure.

If not secure, additional vehicle seat belt tightening may be necessary.

- Unbuckle vehicle seat belt.
- Hold vehicle seat belts together and remove locking clip.
- Shorten length of vehicle lap belt portion slightly by pulling vehicle lap belt through latch plate.
- Re-attach locking clip.
- Buckle vehicle seat belt.

HINT: Press car seat or base down into vehicle seat cushion to help buckle vehicle seat belt.

Test installation to see if car seat or base is secure, if not secure, repeat above steps until car seat is secure.

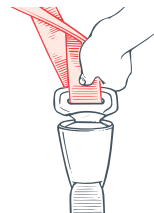

(fig. a)

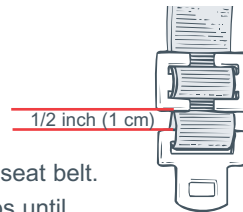

(fig. b)

Section 13 - Additional Information

Certification

This child restraint system conforms to all applicable Federal Motor Vehicle Safety Standards for use in motor vehicles and aircraft.

Aircraft Use

This restraint is Certified for Use in Motor Vehicles and Aircraft (see label on car seat).

Contact airline about their policy on use of child restraints on the Aircraft.

Use this car seat only on forward-facing aircraft seats.

Install car seat on aircraft the same way it is installed in a vehicle.

Warm Weather

Car seat parts can get very hot in the sun or warm weather.

To avoid burns, always check before putting child in car seat.

Vehicle Seat Protection

Protect vehicle seat. Use a thin car seat mat, thin towel or thin blanket under and behind car seat.

Car Seat Useful Life

DO NOT use after 7 years from date of manufacture on label.

Instruction Manual Storage

Store instruction manual inside pouch located on back of seat pad.

Section 14 - Care and Cleaning

Cleaning Seat:

To Remove Seat Pad:

1. Remove shoulder harness.
2. Pull down on corners of pad behind handle adjustment buttons to remove pins from slots.
3. Pull pad off top of car seat back.
4. Pull pad out from seat in front of red stroller latch button to unsnap pins from seat.
5. Pull bottom of pad gently away from car seat bottom pulling out tabs under corners.

To Launder Pad:

1. Machine wash separately in cold water - delicate cycle, no bleach, and drip dry.

To Reassemble Seat Pad:

Reverse above steps for replacing seat pad and harness system.

Cleaning Harness and Crotch Straps:

Surface wash only with mild soap and damp cloth.

If harness straps are frayed or heavily soiled, they **MUST** be replaced.

Cleaning Shell:

Wipe with mild solution of soap and water. Avoid wetting labels.

Never use “household detergents”: they can weaken plastic.

Cleaning Buckle:

Rinse buckle with warm water. **DO NOT** use household detergents. Never lubricate buckle.

Section 15 - Re-use After A Crash

**WARNING****DEATH or SERIOUS INJURY can occur**

- **DO NOT allow any re-use of this car seat after a crash unless crash and car seat meet ALL conditions in “Re-use After A Crash” section of this manual. Do not sell or allow others to use a car seat that has been in a crash and does not comply with ALL of these conditions.**

Car seats are damaged in vehicle crashes and in many cases, the car seat must be destroyed and replaced. However, the National Highway Traffic Safety Administration (NHTSA) advises that if a child restraint (car seat) has been used in a minor crash that the child restraint can continue to be used with your child.

For information on car seat re-use after a crash, check the NHTSA website at:

www.nhtsa.gov/people/injury/childps/ChildRestraints/ReUse/RestraintReUse.htm.

Damage to car seats may be difficult to see or it may be difficult to verify the damage to the car seat. For those situations where any of the NHTSA Child Restraint Re-use criteria has not been met, or if there is uncertainty whether damage to the seat has occurred, NHTSA and Combi USA advise parents or caregivers to contact their automobile insurance company regarding its policy on replacement of seats.

DO NOT risk your child's safety.

Section 16 - Registration Information

Child restraints (car seats) could be recalled for safety reasons. You must register this restraint to be reached in a recall. Fill out the registration card attached to car seat or send your name, address, and the restraint's model number and manufacturing date to:

Combi USA
1962 Hwy 160 West, Suite #100
Fort Mill, SC 29708
or call 1-800-992-6624
or fax 1-803-548-3663
or log onto www.combi-intl.com

For recall information:

- Call the U.S Government's Auto Safety Hotline at 1-800-424-9393 (202-366-0123 in D.C. area)
- Log onto the National Highway Traffic Safety Administration recall website at:
<http://www-odi.nhtsa.dot.gov/cars/problems/recalls/childseat.cfm>
- Contact Combi USA, Inc. (see contact information above)

Section 17 - Limited Warranty

1. Combi Juvenile Products, when purchased from an authorized retailer, are warranted to the original purchaser to be free of defect in materials and workmanship for a period of one (1) year from date of purchase. Warranty is valid for products purchased and used in the U.S. only and used in compliance with the warrantor's use and maintenance instructions. Save your carton and receipt in case return for warranty service is necessary.
2. During the warranty period your Combi product will either be repaired or replaced, at the warrantor's discretion, without charge if it is purchased from an authorized Combi dealer and is found to be defective in workmanship or materials. For service call 1-800-99-COMBI (1-800-992-6624). The warrantor shall not be responsible for any costs incurred by the consumer in returning a defective product for repair.

This limited warranty shall not apply to normal wear to the product, or if the product has been:

- a. Damaged due to accidents, misuse, abuse or neglect as determined by Combi.
- b. Tampered with or repaired by other than an authorized Combi repair center or with parts other than Combi approved parts.
- c. Leased or rented for commercial use.

THE WARRANTY PROVIDED HEREIN IS EXCLUSIVE AND IS IN LIEU OF ALL OTHER EXPRESS WARRANTIES. ANY IMPLIED WARRANTIES, INCLUDING ANY IMPLIED WARRANTY OF MERCHANTABILITY OR FITNESS FOR A PARTICULAR PURPOSE ARE EXPRESSLY EXCLUDED. WARRANTOR'S OBLIGATIONS AND THE CONSUMER'S OR OTHER BUYERS REMEDIES UNDER THE LIMITED WARRANTY ABOVE ARE EXCLUSIVE AND ARE STRICTLY LIMITED TO REPAIR OR REPLACEMENT AS STATED. ANY INCIDENTAL OR CONSEQUENTIAL DAMAGES ON THE PART OF THE WARRANTOR AND ANY SUPPLIER OR DEALER ARE HERBY ALSO EXPRESSLY EXCLUDED.

Some states limit or do not allow exclusions or limitations on how long an implied warranty lasts so the above limitations may not apply to you. Some states do not allow the exclusion or limitations of incidental or consequential damages, so the above limitations or exclusion may not apply to you. This warranty gives you specific legal rights, and you may also have other rights which vary from state to state.

The logo for Combi, featuring the word "Combi" in a bold, sans-serif font with a registered trademark symbol (®) to its right. The logo is enclosed in a rounded rectangular border.

Designed by Parents, for Parents

Keep this instruction manual for future use.
Store inside pouch located on back of seat pad.

© 2004 Combi USA, Inc.

8040 1204

Combi USA • 1962 Hwy 160 West, Suite #100 • Fort Mill, SC 29708
• For Technical Questions, Please Call 1-800-992-6624
• Se Habla Español 1-803-548-6633 • Fax 1-803-548-3663 • www.combi-intl.com