

LUMEX®
A Graham-Field Brand

AltaDyne® Plus 760000

ALTERNATING PRESSURE / LOW AIR LOSS MATTRESS SYSTEM



USER MANUAL

**Important: Do not operate the Mattress System
without first reading and understanding this manual!
Save this manual for future use.**

CONTENTS

INTRODUCTION	3
INTENDED USE OF THIS DEVICE	3
IMPORTANT SAFETY PRECAUTIONS	3
DANGER	4
WARNING	4
CAUTION	5
EQUIPMENT SYMBOLS	5
PRODUCT DESCRIPTION.....	6
PUMP AND MATTRESS SYSTEM	6
PUMP: FRONT.....	6
PUMP: REAR	7
PUMP: FRONT PANEL.....	7
FRONT PANEL FIRST ROW (CYCLE TIME ADJUSTMENT).....	7
FRONT PANEL SECOND ROW (PRESSURE ADJUSTMENT)	7
FRONT PANEL THIRD ROW (THERAPY MODE ADJUSTMENT).	7
FRONT PANEL FOURTH ROW	8
INSTALLATION	9
UNPACKING	9
PUMP AND MATTRESS INSTALLATION	9
OPERATION.....	10
PRESSURE ADJUSTMENT	11
QUICK DISCONNECT	11
TRANSPORT CAP	12
CPR FUNCTION	12
MAINTENANCE.....	12
CLEANING	12
GENERAL MAINTENANCE.....	13
FUSE REPLACEMENT	13
AIR FILTER REPLACEMENT	13
STORAGE	14
SPECIFICATIONS.....	14
WARRANTY	15

GF, Graham-Field, Lumex and AltaDyne are registered trademarks of GF Health Products, Inc.

GF Health Products, Inc. is not responsible for typographical errors. Packaging, warranties, specifications and products are subject to change without notice.

INTRODUCTION

Use this manual for set-up and operation of the Alternating Pressure / Low Air Loss Mattress System. Read all instructions before using the mattress system. Save this manual for future reference.

INTENDED USE OF THIS DEVICE

The intended use of the Alternating Pressure / Low Air Loss Mattress System is:

- The treatment of pressure ulcers while optimizing user comfort.
- Pain management as prescribed by a physician.
- As described above, in either a homecare or long-term care setting.

IMPORTANT SAFETY PRECAUTIONS

The safety statements presented in this chapter refer to the basic safety information that should be observed by those using the Alternating Pressure / Low Air Loss Mattress System. There are additional safety statements in other chapters or sections, which may be the same as or similar to the following, or specific to the operations.

⚠ DANGER: Indicates an imminent hazard situation that, if not avoided, will result in death or serious injury.

⚠ WARNING: Indicates a potential hazard situation or unsafe practice that, if not avoided, could result in death or serious injury.

▲ Caution: Indicates a potential hazard or unsafe practice that, if not avoided, could result in minor personal injury or product/property damage.

Note: Provides application recommendations or other useful information to ensure that you get the most from your product.

DANGER

To reduce the risk of electrocution:

- ⚠ **DANGER:** Always unplug this product immediately after using.
- ⚠ **DANGER:** Do not use this product while bathing.
- ⚠ **DANGER:** Do not place or store this product where it can fall or be pulled into a tub or sink.
- ⚠ **DANGER:** Do not place this product in or drop into water or other liquid.
- ⚠ **DANGER:** Do not reach for a product that has fallen into water. Unplug it *immediately*.

WARNING

To reduce the risk of burns, electrocution, fire, or personal injury:

- ⚠ **WARNING:** Do not leave this product unattended when plugged in.
- ⚠ **WARNING:** Always use close supervision when this product is used by, on, or near children or those who require close supervision.
- ⚠ **WARNING:** Use this product only as intended and described in this manual. Do not use attachments or accessories not recommended by Graham-Field.
- ⚠ **WARNING:** Never operate this product if
 - a) it has a damaged cord or plug
 - b) it is not working properly
 - c) it has been dropped or damaged
 - d) it has been dropped into water.

Return the product to your Graham-Field equipment provider.





- ⚠ **WARNING:** Keep the cord away from heated surfaces.

- ⚠ **WARNING:** Never block the air openings of this product or place it on a soft surface, such as a bed or couch, where the openings may be blocked. Keep the air opening free of lint, hair, and other similar particles.
- ⚠ **WARNING:** Never drop or insert any object into any opening or hose.
- ⚠ **WARNING:** Do not use this product in the presence of flammable anesthesia, or where oxygen or nitrous oxide is being administered.
- ⚠ **WARNING:** Connect this product *only* to a properly grounded power outlet.
- ⚠ **WARNING:** Maximum patient weight capacity for this product is 400 lb (189 kg).

CAUTION

- ▲ **Caution:** The pump can be used only with the accompanying mattress. Do not use it for any other purpose.

EQUIPMENT SYMBOLS

	Attention! Consult accompanying documents (this manual)
	Indicates that this product is according to the degree of protection against electric shock for type BF equipment
	Functional earth (for UL only)
	Class II (for UL only)
	Disposal of Electrical & Electronic Equipment (WEEE): Do not treat this product as household waste. For more detailed information with regard to returning and recycling this product, please consult your local city office, household waste disposal service, or Graham-Field Health Products equipment provider.

For U.S. and Canada only

E228589
53DG



Medical Equipment: Air Pump
with respect to electrical shock, fire and
mechanical hazards only in accordance with
UL60601-1 and CAN/CSA C22.2 No. 601.1

PRODUCT DESCRIPTION

PUMP AND MATTRESS SYSTEM

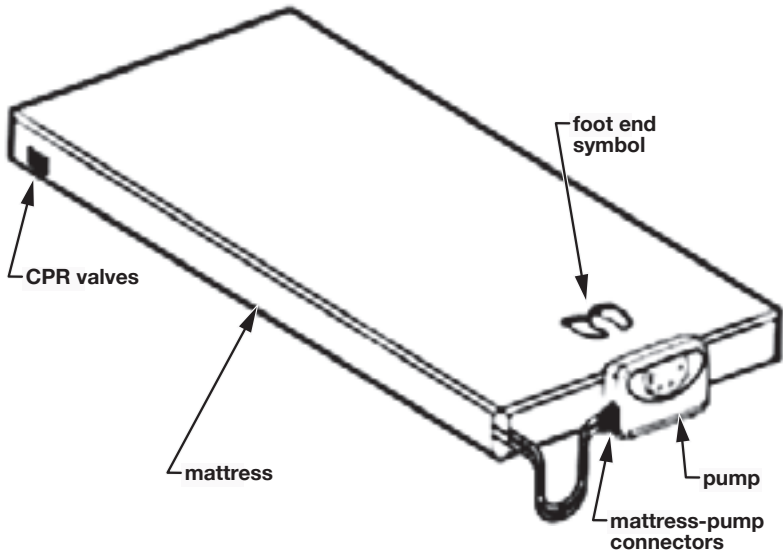

pump and mattress system

PUMP: FRONT



PUMP: REAR

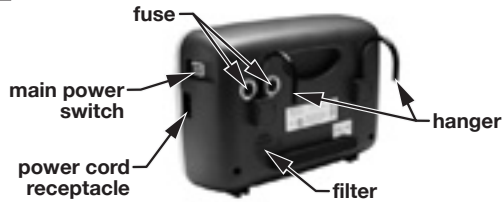

PUMP: FRONT PANEL

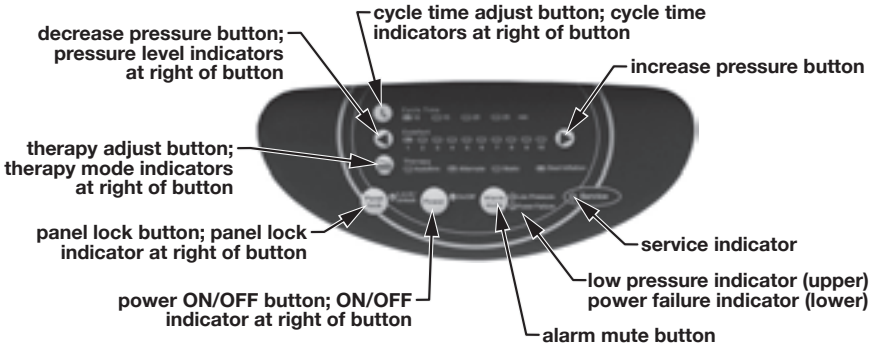

Front panel first row (cycle time adjustment)

There are four cycle time settings. Press the cycle time adjust button to cycle between the settings. The selected cycle time setting's indicator will illuminate.

Front panel second row (pressure adjustment)

There are ten pressure (firmness) settings. Press the decrease pressure button at the left end of the row to decrease pressure (softer), and press the increase pressure button at the right end of the row to increase pressure (firmer). The selected pressure level setting's indicator will illuminate.

Front panel third row (therapy mode adjustment)

There are four therapy mode settings: **Autofirm** (to fill mattress quickly, or to fully inflate mattress during patient ingress/egress for better support), **Alternating Pressure** (every other tube fills, then deflates), **Static** (all tubes remain full), and **Seat Inflation** (when the head is raised to

increase pressure under the buttocks). Press the therapy adjust button at the left end of the row to cycle between the settings. The selected therapy mode setting's indicator will illuminate.

Front panel fourth row

Panel lock button: The panel lock protects the panel settings from accidental change. Press to lock; press for three seconds to unlock. When the panel remains untouched for three minutes, it locks automatically. When the panel is locked, the panel lock indicator will illuminate.

Power button (ON/OFF): The power button turns power to the mattress system ON or OFF. Press to turn ON; press to turn OFF. When power is on, the power (ON/OFF) indicator will illuminate. When power is turned OFF, mattress system will slowly deflate. *Note: Main power switch on side of pump must be ON in order for the panel power button to function.*

Alarm mute button: The alarm mute button temporarily suspends the LED indicator and buzzer when either the low-pressure alarm or power failure alarm is activated. Should the problem not be resolved within five minutes, the alarm will resume.

Low pressure indicator: The low pressure indicator illuminates, and the alarm sounds, when pressure level is lower than the selected pressure. If the low pressure indicator persistently illuminates inappropriately:

1. Check to ensure all connections are properly and securely connected per installation instructions.
2. Check for any leakage (tubes or connecting hoses). If necessary, contact your Graham-Field equipment provider to replace any damaged tubes or hoses.
3. If problem persists, contact your Graham-Field equipment provider.

Power failure indicator: The power failure indicator illuminates, and the alarm sounds, when there is a power failure. Depress the alarm mute button to disable both alarm and LED.

Service indicator: Mechanical failure, service required; contact your Graham-field equipment provider.

INSTALLATION

UNPACKING

1. Before unpacking, check for obvious damage to the carton or its contents. If damage is evident, please notify the carrier and your Graham-Field equipment provider.
2. Remove all loose packing from the carton.
3. Carefully remove all components from the carton.
4. Inspect all components. If damage is evident, please notify the carrier and your Graham-Field equipment provider.

PUMP AND MATTRESS INSTALLATION

1. Remove all sheets, blankets, and pillows from the bed.
2. Place the mattress on top of the bed frame; ensure that the foot end symbol faces up at foot end as shown at right. Secure mattress to bed with straps.

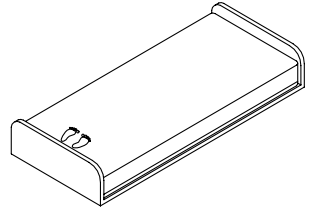

3. Fold open the wire hangers on the back of the pump as shown at right.



4. Either hang the pump on the bed's foot end, as shown at right, or place the pump on a flat surface easily accessible to the caregiver and/or doctor.



▲ **Caution:** Place the device in a position where the caregiver and/or doctor can access it easily.

5. Connect the mattress-pump air hose quick connector; ensure that the connector has clicked securely into place before continuing.



▲ **Caution:** Ensure that the air hoses are not kinked or tucked under the mattress.

⚠ **WARNING:** Locate all cords so that they will not be stepped on, tripped over, or otherwise subjected to damage or stress.

⚠ **WARNING:** Do not use a household extension cord if the electrical cord does not reach the power outlet. Use of an improper extension cord could result in fire and electric shock. If an extension cord must be used, use a three conductor cord with ground, properly wired, in good electrical condition, and keep it as short as possible.

⚠ **WARNING:** Ensure that the local power voltage is appropriate for the pump unit.

6. Plug the power cord into a properly grounded electrical outlet.

OPERATION

1. Turn the main power switch to the ON position.



2. Press the front panel power button. The power indicator will illuminate.



Note: The mattress system will automatically enter Autofirm mode for the quickest inflation at set-up; initial inflation takes approximately twenty minutes.

3. The pump will begin delivering air into the mattress.
4. When the selected pressure level is reached, the pump will enter alternating mode. The mattress can then be adjusted to the desired pressure.
5. Replace all sheets, blankets, and pillows on the bed.

PRESSURE ADJUSTMENT

Generally, a lighter patient will need a lower (softer) setting while a heavier patient will need a higher (firmer) setting, but pressure adjustment must ultimately be based on the patient's *weight distribution*. A short, stocky person may be the same weight as a tall, thin person, but their settings will not be the same. The mattress should be firm enough to support the patient, yet soft enough so the patient will sink down to eliminate pressure points. Initially inflate the mattress to maximum pressure. Then, when patient lies on the mattress, test the pressure by placing four fingers below the mattress under the patient's buttock area; your fingers should just fit. If the fit is too loose, decrease the setting. If your fingers do not fit well, increase the setting two notches firmer. Wait ten minutes and then check again. You should only have to adjust this setting one time per patient. Please consult your physician for an appropriate setting.

QUICK DISCONNECT

Pull the power plug from the wall connector to disconnect the device quickly.

TRANSPORT CAP

In case of power failure or transport: Disconnect the quick connector and cap the mattress with the transport cap to slow deflation.

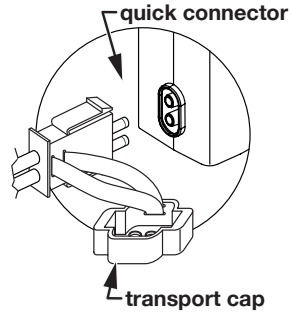

CPR FUNCTION

If CPR must be performed on the patient while the mattress is in use, to immediately deflate the mattress, either:

1. Pull the CPR valves from the mattress in the location of the arrow shown at right, or
2. Disconnect the quick connector from the pump in the location of the arrow shown at right.

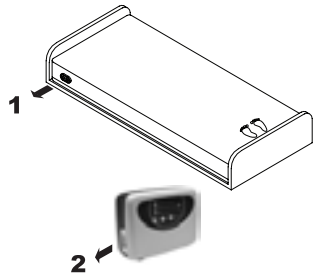

MAINTENANCE

CLEANING

Perform the following cleaning procedures before use.

Pump: Wipe the pump with a clean, damp cloth and mild detergent, and keep it away from dust. Air dry.

▲ **Caution: Do not use corrosive or powdered cleansers to clean the pump.**

▲ **Caution: Do not immerse or soak the pump.**

▲ **Caution: Do not clean with phenolic products.**

Mattress: Wipe the mattress unit with a clean, damp cloth and mild detergent. The mattress may also be cleaned using a 10% solution of sodium hypochlorite (bleach) diluted in water. Air dry all parts thoroughly before use.

▲ **Caution: Do not clean with phenolic products.**

▲ **Caution: After cleaning, air dry the mattress without direct exposure to sunlight.**

GENERAL MAINTENANCE

1. Check main power cord for abrasion or excessive wear.
2. Check mattress cover for signs of wear or damage. Ensure mattress cover and tubes are connected correctly.
3. Check airflow from the air hose connector. The airflow should alternate between each connector every half-cycle time if it's in alternating mode.
4. Check the air hoses for any kink or break. For replacement, please contact your GF equipment provider.

Fuse replacement

tool needed: small screwdriver

1. If you suspect a blown fuse, disconnect the plug from the wall outlet immediately.
2. Use a small screwdriver to remove the cover of the fuse holder (fuse locations are shown in picture at right).
3. Insert a new fuse of the correct rating (T1A/250V, VDE approved).
4. Replace the fuse holder cover. Ensure that fuse holder cover is securely installed.



Air filter replacement

tool needed: small screwdriver

1. Use a small screwdriver to remove the air filter plate located at rear of pump (filter location shown in picture at right).
2. Remove the filter. The filter is reusable, if not torn, and can be washed gently with a mild detergent and water. Dry the filter before use.
3. Replace the filter and cover. Ensure that filter cover is securely installed. Replace the air filter regularly if it is gray, torn, or the environment is dirty.



STORAGE

1. Lay the mattress out flat and upside down.
2. Roll from the head end toward the foot end.
3. Stretch the foot-end strap around the rolled mattress to prevent unrolling.
4. Store mattress and pump in a dust-free environment with no exposure to direct sunlight.

▲ **Caution: Do not fold, crease or stack mattress.**

SPECIFICATIONS

Pump		Specification
Power Supply		120V System: AC 120V 60 Hz Note: see rating label on product
Fuse Rating		T1A, 250V
Cycle time		10, 15, 20 or 25 minutes
Air input		>8 LPM
Dimensions (L x W x H)		11.4" x 7.9" x 4.6" (29.1 x 20 x 11.7 cm)
Weight		5 lb (2.2 kg)
Environment	Temperature	Operation: 50°F to 104°F (10°C to 40°C) Storage: 5°F to 122°F (-15°C to 50°C) Shipping: 5°F to 158°F (-15°C to 70°C)
	Humidity	Operation: 10% to 90% non-condensing Storage: 10% to 90% non-condensing Shipping: 10% to 90% non-condensing
Classification		Class II, Type BF, IPX0 Applied Part: Air Mattress Not suitable for use in the presence of a flammable anesthetic mixture (No AP or APG protection)

Mattress	Specification
Model	8" mattress
Dimensions (L x W x H)	78.7" x 35.4" x 8" (200 x 90 x 20.3 cm)
Weight	16.5 lb (7.5 kg)

WARRANTY

GF Health Products, Inc. warrants the Lumex AltaDyne Plus 760000 Alternating Pressure / Low Air Loss Mattress System for a period of twelve months for defects in workmanship and materials. During the warranty period, defective items will be repaired or replaced at GF Health Products' option at no charge.

USA, Corporate Headquarters:

**Graham-Field Health Products
2935 Northeast Parkway
Atlanta, Georgia 30360**

telephone: 800-347-5678, 770-447-1609

fax: 800-726-0601, 678-291-3232



www.grahamfield.com

760000-INS-LAB-RevA08

© 2008 GF Health Products, Inc.