



# CRESCENT RIM™ 9'x9'

## Instructions apply to Part Number 9234-909

### When You Are Ready To Set Up Your Tent

- Select a level campsite clear of rocks, branches and other hard or sharp objects.
- Do not set up your tent under trees.
- For best results in windy conditions, position the end of tent into the wind.

Main Tent Pole

Part No. 9234-320



Rainfly Poles

Part No. 9234-322

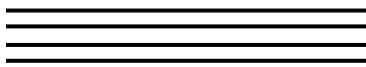

Rainfly Part No. 9234-324

## 1 Layout & Positioning of Tent, Pole Assembly

- Layout and position tent with door facing desired direction. (illus. 1)
- Unzip door.
- Stake down tent, using the rings on the stake loops. Keep the floor taut. (illus. 2)
- Assemble frame poles by interlocking shock-corded poles. (four poles)
- Insert the main tent poles through the two pole sleeves that go side to side, parallel to the front of the tent. (illus. 1)
- Insert two main poles through the pole sleeves running the opposite direction. these poles should be on top of the first two poles where they cross.

Assembled black main tent poles inserted through pole sleeves in both directions.

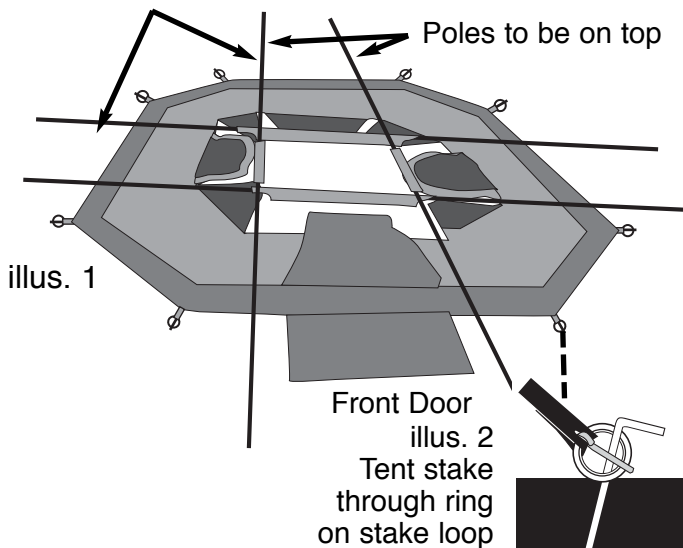

## 2 Connect Frame to Tent

- Insert the pin into the ends of the top main tent pole at the rear of the tent. (illus. 3, illus. 4)
- Go to opposite end of pole and gradually apply pressure to the pole forming an arch until you are able to insert the pin into the pole end. (works best standing in the door, with two people) Repeat for second pole.
- Insert the pin on the side into the side to side main pole end. Go to opposite end of pole and gradually apply pressure to the pole forming an arch until you are able to insert the pin into the pole end. Repeat for second pole. (illus. 3, illus. 4)

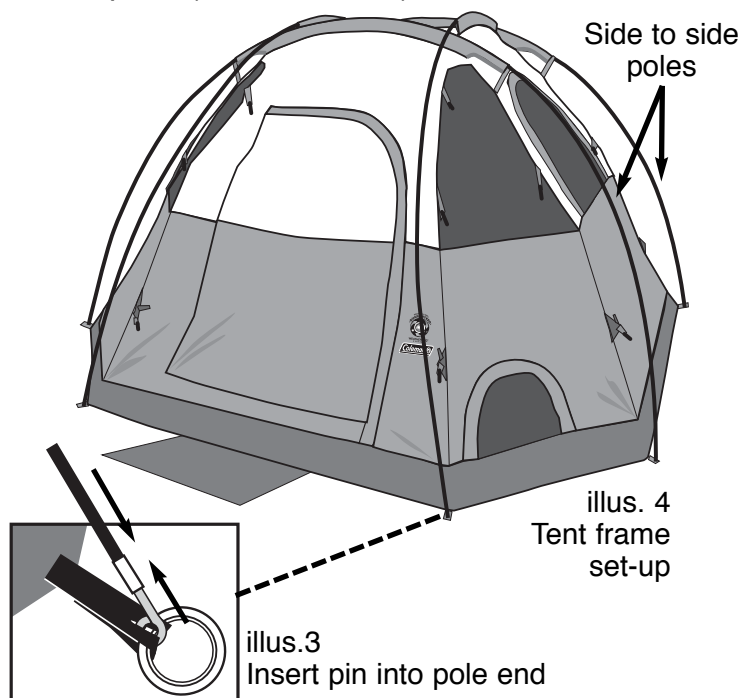

# 3 Attach Tent to Frame Using Frame Clips

- Attach frame clips along the edges of tent to frame poles. (illus. 5), (illus. 6)
- Make any adjustments to the tent corner stakes that are needed.

**NOTE:**  
Grommets for rainfly pole are on frame clip webbing

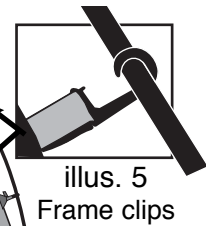

illus. 6  
Assembled tent without rainfly.



# 4 Attach Rainfly

- Assemble rainfly poles by interlocking shock-corded poles.
- Insert rainfly poles through pole sleeves located at the center of the curved edges of the underside of rainfly. (illus. 7), (illus. 9)
- Drape rainfly over tent frame, pole side down. Rainfly poles should be over door, rear and sides of tent.
- Connect the eight elastic loops with hooks, (found at the rainfly corners) to the eight fabric loops on the bottom row of frame clips. (illus. 8), (illus. 9)
- Insert the tips of the rainfly poles into the grommets on the frame clip webbing. (See above illus. 6)
- Secure rainfly with attachments located on underside of fly. (illus. 8)

illus. 7 Insert rainfly poles through the 4 pole sleeves on underside of rainfly

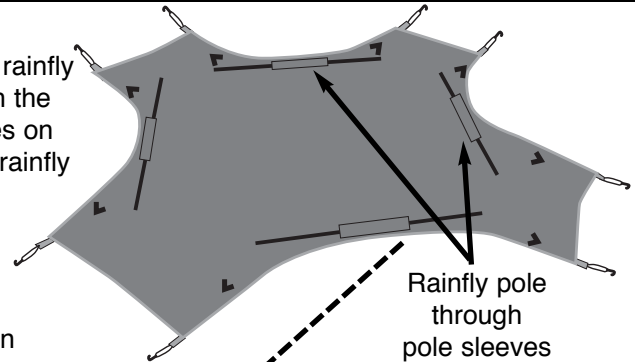

Rainfly pole in grommet

Underside of rainfly attaches to frame poles

Hooks attaches to fabric loop

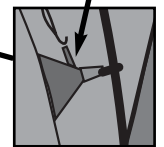

illus. 9  
Completed tent with rainfly.

Rainfly hooks attach to fabric loops on the corner frame clips (illus. 8)

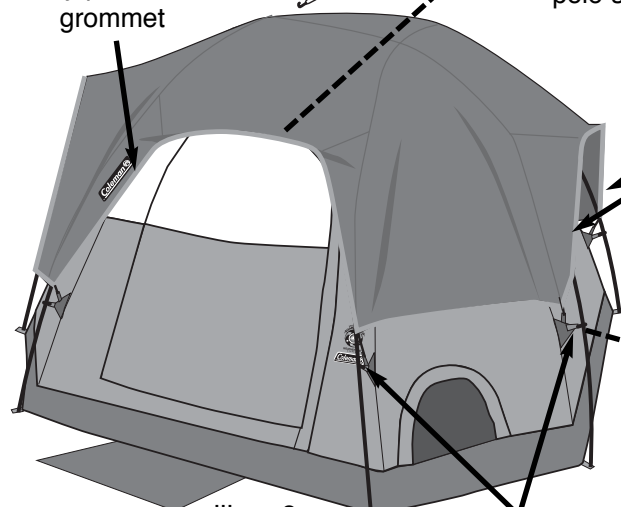

## Things You Should Know

- Under certain conditions (cold weather, high humidity, etc.) condensation will form on the inside surfaces of your tent. Condensation is caused by water vapor from your breath, perspiration, or any wet clothing inside your tent. It is NOT LEAKAGE through the tent fabric. It can be minimized by removing wet clothing from your tent and by providing good ventilation through the tent.

- Never store tent, even for a short period of time, without drying it thoroughly and brushing off caked dirt. Do not pack stakes or poles inside your tent. Use a separate storage bag.

- STAKES SHOULD BE REMOVED BY PULLING ON THE STAKE ITSELF. NEVER PULL ON THE TENT FABRIC OR TENT STAKE LOOP TO REMOVE STAKE.

- TENT POLES SHOULD NOT BE LEFT TELESKOPED TOGETHER DURING STORAGE.

- Seam sealer has not been provided with your tent. For additional protection we recommend seam sealing your tent prior to camping. Seam sealer may be purchased through your local retailer or at your local sporting goods store.

- Do not leave your tent set-up for weeks at a time, be aware that exposure to the ultraviolet rays of the sun can seriously damage material and/or cause it to become discolored.

**WARNING: KEEP ALL FLAME AND HEAT SOURCES AWAY FROM THIS TENT FABRIC. This tent meets the flammability requirements of CPAI-84. The fabric will burn if left in continuous contact with any flame source. The application of any foreign substance to the tent fabric may render the flame-resistant properties ineffective.**



**THE COLEMAN CO., INC.**  
3600 N. Hydraulic • Wichita, Kansas 67219  
1-800-835-3278 • www.coleman.com