

PROFESSIONAL

Model PMD330/PMD331/PMD340 User Guide

Compact Disc Player

marantz®



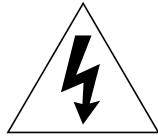
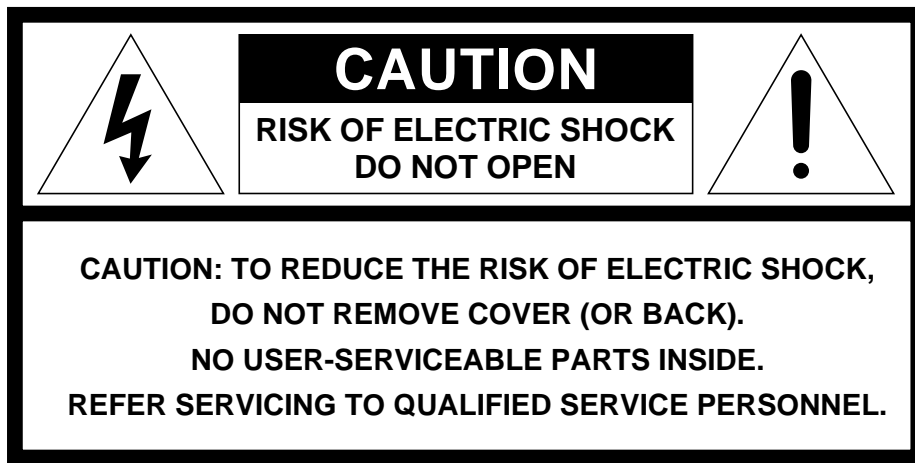

The lightning flash with arrowhead symbol, within an equilateral triangle, is intended to alert the user to the presence of uninsulated "dangerous voltage" within the product's enclosure that may be of sufficient magnitude to constitute a risk of electric shock to persons.



The exclamation point within an equilateral triangle is intended to alert the user to the presence of important operating and maintenance (servicing) instructions in the literature accompanying the product.

WARNING

**TO REDUCE THE RISK OF FIRE OR ELECTRIC SHOCK,
DO NOT EXPOSE THIS APPLIANCE TO RAIN OR MOISTURE.**

**CAUTION: TO PREVENT ELECTRIC SHOCK, MATCH WIDE BLADE
OF PLUG TO WIDE SLOT, FULLY INSERT.**

**ATTENTION: POUR ÉVITER LES CHOCS ÉLECTRIQUES,
INTRODUIRE LA LAME LA PLUS LARGE DE LA FICHE DANS LA BORNE
CORRESPONDANTE DE LA PRISE ET POUSSER JUSQU'AU FOND.**

NOTE:

This equipment has been tested and found to comply with the limits for a Class B digital device, pursuant to Part 15 of the FCC Rules. These limits are designed to provide reasonable protection against harmful interference in a residential installation. This equipment generates, uses and can radiate radio frequency energy and, if not installed and used in accordance with the instructions, may cause harmful interference to radio communications. However, there is no guarantee that interference will not occur in a particular installation. If this equipment does cause harmful interference to radio or television reception, which can be determined by turning the equipment off and on, the user is encouraged to try to correct the interference by one or more of the following measures:

- Reorient or relocate the receiving antenna.
- Increase the separation between the equipment and receiver.
- Connect the equipment into an outlet on a circuit different from that to which the receiver is connected.
- Consult the dealer or an experienced radio/TV technician for help.

NOTE: Changes or modifications may cause this unit to fail to comply with Part 15 of the FCC Rules and may void the user's authority to operate the equipment.

LASER SAFETY

This unit employs a LASER. Only a qualified service person should remove the cover or attempt to service this device, due to possible eye injury.

CAUTION-USE OF CONTROLS OR ADJUSTMENTS OR PERFORMANCE OF PROCEDURE OTHER THAN THOSE SPECIFIED HEREIN MAY RESULT IN HAZARDOUS RADIATION EXPOSURE.

This Class B digital apparatus meets all requirements of the Canadian Interference-Causing Equipment Regulations.

Cet appareil numérique de la Classe B respecte toutes les exigences du Règlement sur le matériel brouilleur du Canada.

IMPORTANT SAFETY INSTRUCTIONS

READ BEFORE OPERATING EQUIPMENT

This product was designed and manufactured to meet strict quality and safety standards. There are, however, some installation and operation precautions which you should be particularly aware of.

1. Read Instructions — All the safety and operating instructions should be read before the appliance is operated.
2. Retain Instructions — The safety and operating instructions should be retained for future reference.
3. Heed Warnings — All warnings on the appliance and in the operating instructions should be adhered to.
4. Follow Instructions — All operating and use instructions should be followed.
5. Water and Moisture — The appliance should not be used near water — for example, near a bathtub, wash-bowl, kitchen sink, laundry tub, in a wet basement, or near a swimming pool, etc.
6. Carts and Stands — The appliance should be used only with a cart or stand that is recommended by the manufacturer.
7. An appliance and cart combination should be moved with care. Quick stops, excessive force, and uneven surfaces may cause the appliance and cart combination to overturn.



8. Wall or Ceiling Mounting — The appliance should be mounted to a wall or ceiling only as recommended by the manufacturer.
9. Ventilation — The appliance should be situated so that its location or position does not interfere with its proper ventilation. For example, the appliance should not be situated on a bed, sofa, rug, or similar surface that may block the ventilation openings; or, placed in a built-in installation, such as a bookcase or cabinet that may impede the flow of air through the ventilation openings.
10. Heat — The appliance should be situated away from heat sources such as radiators, heat registers, stoves, or other appliances (including amplifiers) that produce heat.
11. Power Sources — The appliance should be connected to a power supply only of the type described in the operating instructions or as marked on the appliance.

12. Grounding or Polarization — The precautions that should be taken so that the grounding or polarization means of an appliance is not defeated.

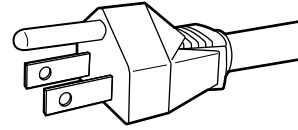

AC POLARIZED PLUG

13. Power-Cord Protection — Power-supply cords should be routed so that they are not likely to be walked on or pinched by items placed upon or against them, paying particular attention to cords at plugs, convenience receptacles, and the point where they exit from the appliance.
14. Cleaning — The appliance should be cleaned only as recommended by the manufacturer.
15. Nonuse Periods — The power cord of the appliance should be unplugged from the outlet when left unused for a long period of time.
16. Object and Liquid Entry — Care should be taken so that objects do not fall and liquids are not spilled into the enclosure through openings.
17. Damage Requiring Service — The appliance should be serviced by qualified service personnel when:
 - A. The power-supply cord or the plug has been damaged; or
 - B. Objects have fallen, or liquid has spilled into the appliance; or
 - C. The appliance has been exposed to rain; or
 - D. The appliance does not appear to operate normally or exhibits a marked change in performance; or
 - E. The appliance has been dropped, or the enclosure damaged.
18. Servicing — The user should not attempt to service the appliance beyond that described in the operating instructions. All other servicing should be referred to qualified service personnel.

CONTENTS

Features	1
CD-TEXT	1
CD-RW Disc Playback	1
Preparation	2
Name and Operation of Each Part	3
Playing a CD	7
Using the Pitch Controls	9
Using the A-B Repeat Function	10
Playback Using the Program Function	11
Playback Using the CUE Function	12
Playback Modes	14
Synchro Recording	15
Using a Remote Control (Not Included)	15
CD-TEXT Information Display	16
Using the Preset Menu	17
Using the Control Port (PMD331/PMD340 Only)	18
Fader Start	19
Troubleshooting	19
Specifications	i
Figures	ii
Connection	iii
External Dimensions	iii

After you unpack the CD player, make sure that all of the following accessories are included:

- This guide
- Power cord
- Stereo audio cable with RCA pins

Features

- Supports CD-TEXT



Look for these symbols on CDs that support CD-TEXT.

- Supports playback of CD-RW (rewritable) discs
- Supports synchronized operation with other Marantz components that support RC5 codes.
- Pitch control +/-12% max., 0.1% steps

- Equipped with the latest Philips pickup mechanisms
 - Model PMD330 (high-performance mechanism)
 - Model PMD331 (high-performance mechanism)
 - Model PMD340 (high-performance, high-durability mechanism)
- Can be installed in standard 19-inch rack (2U)
- Shockproof (PMD331/PMD340) 10 seconds
- Supports instant start (PMD331/PMD340)
- Pitch bend control +/- 8% (PMD331/PMD340)

CD-TEXT

A CD-TEXT disc is a new type of music CD that includes, in addition to the music found on a conventional CD, text data containing the artist's name, the album name, track names, etc. This text data is recorded in an area that was unused on music CDs.

Accordingly, a CD-TEXT disc can be played on any conventional CD player, but the text data can be viewed only if the disc is played on a player that supports the CD-TEXT function, such as the PMD330/331/340.

The player determines automatically whether the current disc is a conventional CD or a CD-TEXT disc.

This player can display the album name, track name, the artist's name, the songwriter's name, the composer's name, and the arranger's name, as long as that information is recorded on the disc. Not all of this information will be present on every disc.

For details on how CD-TEXT is displayed, refer to the description of operation found later in this guide.

- This player can display 12 characters of text at one time. If the text data is longer than 12 characters, the text will scroll across the display from right to left.
- Some CD-TEXT discs include the called "highlights". This CD player does not support the Highlight Scan function to play the highlights in sequence.
- The following languages can be displayed as CD-TEXT: English, French, Spanish, and German.

CD-RW Disc Playback

In addition to conventional music CDs and CD-R discs, this CD player can also play CD-RW discs.

- In order to play a CD-R or CD-RW disc, the TOC* must be recorded properly.

The process of writing the TOC information to the disc is called "finalizing," and if this task was not completed properly, the disc cannot be played back because it will not be recognized properly as a music CD by a regular CD player.

For details, refer to the instruction manual provided with the CD recorder.

- This CD player can only play discs that were recorded in the CD-DA format. Never attempt to "play" a CD-ROM or similar disc containing computer data.
- When playing a CD-RW disc, it sometimes takes longer to read the TOC compared with a music CD or a CD-R disc.
- This CD player may not be able to play some CD-RW discs properly, depending on the conditions under which the disc was recorded.

* "TOC" stands for "Table of Contents," and contains information such as the number of tracks on a disc and the total playback time.

Preparation

Introduction

Thank you for purchasing the Marantz PMD330/PMD331/PMD340 Compact Disc Player.

Please read these operating instructions carefully. We recommend you read the entire user guide before you attempt to connect or operate this player.

The callout numbers indicated on the drawing in the end of this manual correspond to the same numbers in the text.

Precautions

The following precautions should be taken when operating the equipment.

General precautions

- When installing the equipment, ensure the following points:
 - do not expose to excessive heat, cold, moisture or dust.
 - do not expose to direct sunlight.
 - do not expose to electrostatic discharges.
 - never place heavy objects on the equipment.
- do not pull out the AC cord by pulling on the cord; grasp the plug.
- Contact the nearest dealer or customer service if problems occur.

Cautions of Installation

- Install the player horizontally (or within 10 degrees of level). Too much inclination may result in damage to the player.
- Secure the player at four parts when installing it in a 19-inch rack. (See also Figure 3)

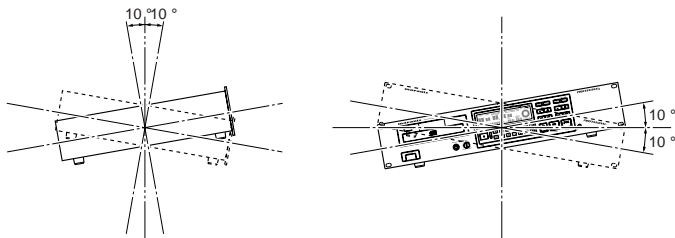

Compact Discs

- Handle discs carefully and do not damage or scratch the data side.
- To protect the disc, avoid placing it in the following locations:
 - in direct sunlight or near a source of heat.
 - in a damp or dirty place.
 - in a place which could be exposed to rain or near a window.
- Keep the disc surface clean.
 - When cleaning the disc surface, use compact disc cleaner and wipe as shown below.

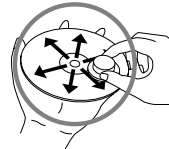

Wipe in a radial direction.

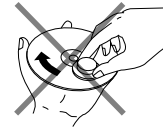

Do not wipe in circumferential direction.

- do not use conventional record cleaner.
- store discs properly by placing them in the disc cases.

Before Turning Off the Power

- Make sure to close the disc tray by pressing the OPEN/CLOSE button before turning off the power.



WARNING



- Do not use force to open or close the disc tray during power off. Force may result in damage to the tray.
- Place nothing but a compact disc in the tray. Inserting objects other than discs in the tray may result in damage to the tray.

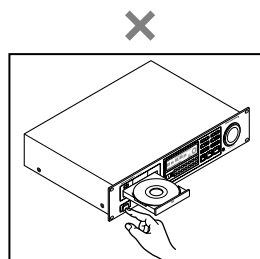

Do not turn off the power while the disc tray is open.

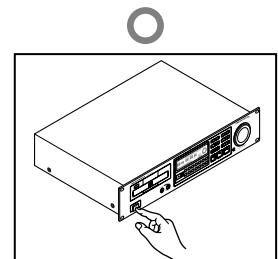

Press the ▲ button to close the disc tray before turning the power off.

Name and Operation of Each Part *

1 ANALOG OUTPUT

(Analog output jacks)

These are the analog signal output jacks. The red jack is the right channel audio output, and the white jack is the left channel audio output jack.

Caution

Do not connect these jacks to the PHONO jacks on an amplifier.

2 DIGITAL OUTPUT (SPDIF)

(Digital output jack)

The digital signal from the compact disc that is being played is output through this jack.

Connect a device with a digital input jack (such as recording equipment, an amp, or a D/A converter) to this jack through a RCA cable.

Note:

When outputting a digital signal from the PMD331/PMD340, set "D.OUT" in the Preset menu to "On".

For details on how to make this setting.

(See also page 17.)

3 FADER START

(Fader start input jack)

An external switch connected to this jack can be used to control disc pause and playback.

(See also page 19.)

On the PMD331/PMD340, this feature is in the CONTROL I/O connector 10.

(See also page 18.)

4 REMOTE INT/EXT

(RC5 remote control internal/external switch)

When using an infrared remote control transmitter to control this CD player, set this switch to "INT". When incorporating this CD player into a system by connecting this CD player (for remote control) to equipment that is equipped with a RC5 compatible output, set this switch to "EXT".

Note:

Please set to "EXT" when you are using this CD player without a remote control. The CD player will then not be able to receive signals from another infrared remote control transmitter.

5 REMOTE RC5 IN/OUT

(RC5 remote control input/output jack)

This CD player can be controlled remotely by connecting this CD player via a remote control cable to other equipment that support RC5.

- If this CD player is to be connected to equipment that is equipped with a RC5 remote control jack, be certain to connect the "REMOTE CONTROL IN" jack on this unit with the "REMOTE CONTROL OUT" jack on the other unit.
- When this CD player is connected to a cassette recorder or a disc recorder (CD-R, CD-RW, etc.), RC5 provides synchro recording capabilities. (See also page 15.)

6 ANALOG BALANCED OUTPUT LEVEL

(Analog balanced output level adjustment)

(PMD331/PMD340 only)

Use a Phillips type screwdriver to adjust the analog balanced output level. Turn the screwdriver clockwise to increase the output level, and turn the screwdriver counterclockwise to decrease the output level. (Min. level = -11 dBu)

Caution

- Do not use excessive force when turning the screwdriver.
- The output level and channel balance are adjusted when the unit is shipped from the factory. Do not change these adjustments inadvertently.

7 ANALOG BALANCED OUTPUT

(Analog balanced output jacks)

(PMD331/PMD340 only)

Connect a device with analog balanced inputs to these jacks through a cable with XLR connectors.

Note:

When connecting another device to this CD player through these jacks, confirm that the pin assignments of the XLR connectors match before making the connection.

If the pin assignments are different, change the connections in the XLR connector cable so that the pin assignments match.

XLR Connector Pin Assignments for this CD Player

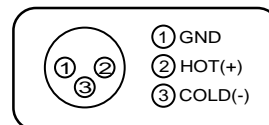

8 DIGITAL OUTPUT (SPDIF)

(Digital balanced output jack)

(PMD331/PMD340 only)

Connect a device with a digital balanced input to this jack through a cable with XLR connectors.

Note:

The digital format output on this balanced connectors is SPDIF. Most products that contain an XLR digital input are designed to accept an AES/EBU format signal. Be aware that the AES/EBU input on some products will not accept SPDIF, even though the audio data is identical.

* Refer to the figures on the pages at the back of this user's guide. The callout numbers on the figures correspond to those found in the text.

Name and Operation of Each Part

9 DIGITAL OUTPUT (SPDIF)

(Optical digital output jack)

(PMD331/PMD340 only)

The digital signal from the compact disc that is being played is output through this jack.

Connect a device with an optical digital input jack (such as recording equipment, an amp, or a D/A converter) to this jack through an optical cable.

Notes:

- Be careful not to bend the optical fiber cable.
- Be sure to attach the connector caps when the OPTICAL connectors are not used.

10 CONTROL I/O

(Control I/O jack)

(PMD331/PMD340 only)

This is the remote control input/output connector.

(See also page 18.)

11 POWER CONNECTOR

Connect the power cord to this connector and connect the other end of the power cord to an AC outlet.

1 POWER (Power button)

Press this button once to turn the power on; press it again to turn the power off.

2 DISC TRAY

This is the disc tray on which the CD is placed.

Press the ▲ button ⑥ to open and close the disc tray.

3 HEADPHONE (Headphone output jack)

Plug headphones into this jack.

The headphone volume level can be adjusted by using the headphone level ④ control.

4 LEVEL (Headphone volume level adjustment)

This knob is used to adjust the headphone volume level.

5 LCD Display

This displays the playing time, various playback modes, etc.

6 ▲ (Disc tray open/close)

Press this button to open the disc tray ②.

Place a compact disc on the tray with the label facing up, and then press this button again to close the tray.

7 TIME (Time display)

Press this button to cycle the display ⑤ through the following displays: track remaining time → track elapsed time → disc remaining time → disc elapsed time → total disc playing time → back to “track remaining time”, etc.

8 TEXT (CD text display)

Press this button while a CD-TEXT disc is in the CD player to switch the character display ⑤ from a time indicator display to a text display.

Subsequent presses of this button will toggle through the available CD-TEXT displays.

(See also page 16.)

9 0 to 9 (Numeric buttons)

These buttons are used to select tracks. When registering tracks for programmed playback, use these buttons to specify the tracks.

10 PRESET

Press this button to put the player in Preset Setting mode.

(See also page 17.)

11 PROG (Program)

Press this button to put the player in Program Registration mode.

(See also page 11.)

Name and Operation of Each Part

12 ◀◀ (Track skip back)

Press this button while a CD is playing to send the player back to the beginning of the current track. Pressing this button more than once sends the player back that many tracks.

13 ■ / EXIT (Stop/Exit)

- This button has two functions: STOP and EXIT.
- Press this button to stop a CD that is currently playing.
- In Play Mode/Preset setting or Program entry mode, press this button to return to the normal mode.
- Press this button twice to clear a set CUE point.

14 ▶▶ (Track skip forward)

Press this button while a CD is playing to send the player ahead to the beginning of the next track. Pressing this button more than once sends the player ahead that many tracks.

15 CUE/CLEAR

This button has two functions: CUE and CLEAR.

- Press this button to perform the cue operation.
(See also page 12.)
- In program entry mode, press this button to clear a programmed track.
- In Play Mode/Preset setting mode, press this button to cancel a change that has not been confirmed.

16 ◀◀ (Fast reverse)

When playing a CD, press this button to scan backwards quickly through the current track.

17 ▶/II (Play/pause), ENTER

This button has three functions: PLAY, PAUSE, and ENTER.

- If playback is paused or when performing a search, press this button to begin playing the CD.
- If the CD is stopped, pressing this button causes the CD player to search for the first track and begin playing.
- If the CD is playing, pressing this button pauses playback. While a CD is paused, the ▶/II 17 button flashes.
- In Play Mode/Preset setting or Program entry mode, press this button to save a change.

18 ▶▶ (Fast forward)

When playing a CD, press this button to scan forwards quickly through the current track.

19 CONTRAST (LCD contrast)

This is used to adjust the LCD display⁵ contrast. Turning this control clockwise using a small screwdriver causes the display contrast to become stronger; turning this control counterclockwise causes the display to become fainter.

Caution

Do not use excessive force when turning the screwdriver.

20 PITCH/SEARCH (Pitch/Search dial) (PMD331/PMD340 only)

While playing

Turn this dial in the clockwise direction to increase the pitch speed; turning this dial in the counterclockwise direction decreases the pitch speed. (maximum: +/-12%)

The position of the pitch control is indicated on the LCD display .

While paused

To conduct a frame search in the forward direction, turn this dial clockwise; to conduct a frame search in the reverse direction, turn this dial counterclockwise.

21 INDEX –

Press this button to search for the previous index.

Each time the INDEX – button is pressed, the INDEX number that is displayed decreases by "1".

22 MODE

Press this button to change or check the playback mode.
(See also page 14.)

23 END

- Press this button while playback is paused to monitor the end of the track. The monitor time can be set between 5 to 35 seconds through the Preset menu.

(See also page 17.)

- The END button lights while the End Monitor operation is in progress.

24 INDEX +

Press this button to search for the next index.

Each time the INDEX + button is pressed, the INDEX number that is displayed increases by "1".

Name and Operation of Each Part

25 A - B

This button is used to specify a start point A and an end point B for repeated playback between the two points.

(See also page 10.)

26 PITCH ON/OFF

- Press this button again to return the PITCH speed to the value indicated on the LCD display ⑥.
- Press this button while the PITCH speed has been changed to return the playback speed to 0 % (no change).

(See also page 10.)

27 PITCH + (PMD330 only)

Press this button to increase the CD PITCH speed.

(maximum: +12%)

28 PITCH - (PMD330 only)

Press this button to decrease the CD PITCH speed.

(maximum: -12%)

27 PITCH BEND + (PMD331/PMD340 only)

Press this button to temporarily increase the PITCH speed of the CD that is currently being played back.

(+8%)

(See also page 10.)

28 PITCH BEND - (PMD331/PMD340 only)

Press this button to temporarily decrease the PITCH speed of the CD that is currently being played back.

(- 8%)

(See also page 10.)

29 IR (Infrared remote sensor)

This sensor picks up signals from a RC5 based infrared remote control transmitter.

Note:

This unit does not come with an infrared remote control transmitter.

Please contact your dealer for more information on available remote controls for this CD player.

Display

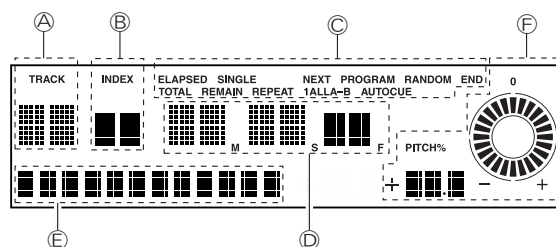

① TRACK

Displays the disc track number.

② INDEX

Displays the disc index number.

③ Operation display

Displays the play mode that is set.

④ Playing time display

Displays the position on the disc currently being played, with "M" representing minutes, "S" representing seconds, and "F" representing frames.

Note:

There are 75 frames in each second.

⑤ Character display

- Displays messages when performing a preset operation or a programming operation.
- The 10-segment bar indicates the track playing position.
- Displays CD-TEXT information.
- Also displays other various messages.

⑥ PITCH display

Displays the PITCH speed numerically with a precision of 0.1%. The round pitch indicator also changes according to the pitch speed.

Playing a CD

Playing a CD

Procedure

1. Press the **POWER** button ① to turn on the power.



2. Press the **▲** button ⑥.

When the **disc tray** ② opens, place a disc on the tray with the label facing up. Press the **▲** button ⑥ again to close the tray. (It is also possible to close the tray by pressing on it gently.) The **▶/||** button ⑰ flashes, and the CD player pauses at the beginning of the first track.

Tips:

- The track operation to be performed after a track is selected, after the tray is closed, or after the power is turned on can be selected through a combination of No.1 **"AutoCue:"** and No.13 **"Start:"** from the Preset menu.

Track operation selected through combination of **"AutoCue:"** and **"Start."**

Preset Menu		Action (Initial values bold)	
"Start:"	"AutoCue:"	After track selection	After tray closing or at Power On:
Stop	Off	Play selected track	Stop
	On	Autocue & Pause selected track	Stop
Pause	Off	Pause selected track	Pause track 1
	On	Autocue & Pause selected track	Autocue & Pause track 1
Play	Off	Play selected track	Play track 1
	On	Autocue & Pause selected track	Autocue & pause track 1

- If **"AutoCue:"** is set to **"ON"** in the Preset menu, the autocue function will search for audio that is > -40dB (Initial value) and then pause at that point. (See also page 17.)

3. Press the **▶/||** button ⑰.

As soon as this button is pressed, the **▶/||** button ⑰ lights and playback begins.

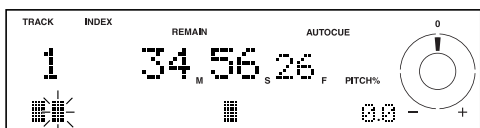

The track number ④ currently being played and the remaining playing time ⑤ are shown on the display ⑤. At the bottom of the display ⑥, the 10-segment bar indicates the playback position.

Tip:

If preset menu item No.19 **"Alert:"** is set to **"On,"** playback time display ⑤ stops when the sound is interrupted, and "Inter-ruption" is displayed in the display section ⑥.

To restore the normal elapsed time display, press any button.

PMD331/PMD340 only:

If preset menu item No.15 **"D.OUT:"** is set to **"Off,"** the shock-proof feature is enabled.

The shockproof feature allows playback to continue without any interruption in sound (up to 10 seconds) due to data dropout if the player is subjected to a strong physical shock.

Note:

The contents of the time display vary if the playing time display is switched. (See also page 8.)

At the start of a track

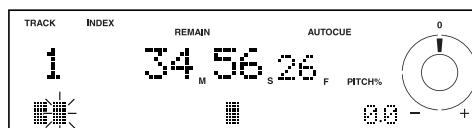

In the middle of a track

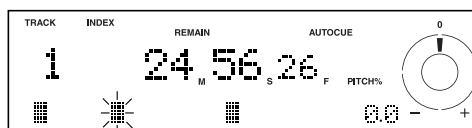

At the end of a track

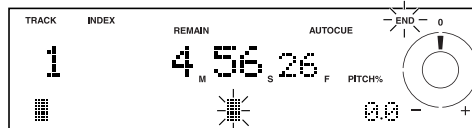

When the last track is finished, the disc automatically stops.

Note:

The operation of the CD player at the end of playback varies according to the playback mode.

(See also page 14.)

Tip:

You can select (through the Preset menu) to have "END" flash on the display ⑤ during the last 0 to 35 seconds of a track. (See also page 17.)

Pausing Playback

If the **▶/||** button ⑰ is pressed while a CD is playing, the **▶/||** button ⑰ will blink and playback is paused.

To resume playback, press the **▶/||** button ⑰ again.

Tip:

The changes in the playback state when the **▶/||** button ⑰ is pressed are illustrated below.

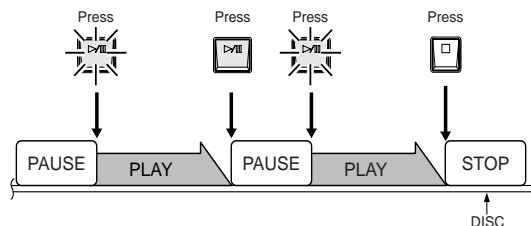

Playing a CD

Stopping Playback

Press the ■ button ⑬.

Playing a CD Again from the First Track

Press the ►/|| button ⑰.

Removing a Disc

Press the ▲ button ⑥ to open the **disc tray** ②, and then remove the disc. Press the ▲ button ⑥ again to close the **disc tray** ②.

Note:

Always close the disc tray ② when it is not in use.

Tips:

- There is an "Auto Close" feature for the **disc tray** ②. In the Preset menu, set one of the following for "**Auto CLS: OFF**" (initial value), 10 seconds, 30 seconds, 60 seconds, or 180 seconds.
- If "**Tray Lock:**" is displayed and the tray does not open even if the ▲ button ⑥ is pressed while a track is playing or while paused, the tray lock setting is set to "On" (initial value). The setting can be cancelled by switching No.11 "**Tray Lock:**" on the Preset menu to "Off:."

Changing the Time Display

Pressing the **TIME** button ⑦ cycles the time display through the following modes:

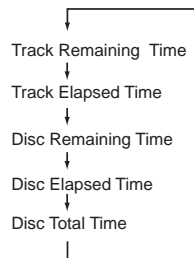

Playing Time Display Example

Track Remaining Time

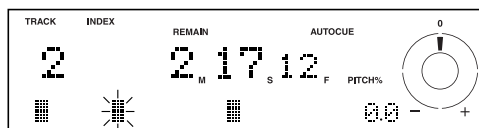

Track Elapsed Time

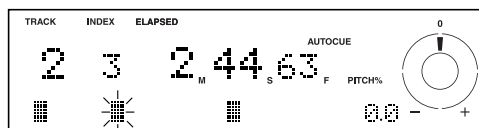

Disc Remaining Time

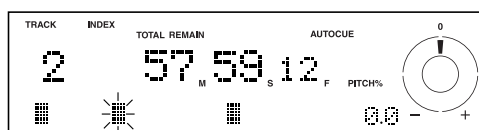

Disc Elapsed Time

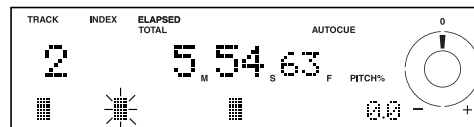

Disc Total Time



Searching (Searching for a Desired Position in a Track)

- While playing or in pause, press the ►► button ⑱ to scan in the forwards direction.
- While playing or in pause, press the ◀◀ button ⑲ to scan in the reverse direction.

<During playback> Searching

For the first three seconds after the ◀◀ button ⑲ or the ►► button ⑱ is held down, the CD player scans at slow speed (about 2x normal playing speed).

For the next three seconds, the CD player scans at medium speed (about 4x normal playing speed).

After that, the CD player scans at high speed (about 16x normal playing speed).

<During pause> Frame Searching

If the ◀◀ button ⑲ or the ►► button ⑱ is pressed once, the play position moves one frame.

If the ◀◀ button ⑲ or the ►► button ⑱ is held down, the search speed changes through three stages after every three seconds, until a maximum speed of 75 frames per second (about 1x normal playing speed) is reached.

Tip:

One frame contains data for about 1/75 of a second of playback.

Turning the PITCH/SEARCH dial ⑳ has the following effect (PMD331/PMD340 only):

<When paused> Frame Searching

- Each time the PITCH/SEARCH dial ⑳ is turned clockwise, the play position advances one frame.
- Each time the PITCH/SEARCH dial ⑳ is turned counterclockwise, the play position reverses one frame.
- If the PITCH/SEARCH is turned quickly, the search speed changes through three stages until a maximum of 75 frames per second is reached.

Tip:

One frame contains data for about 1/75 of a second of playback.

Playing a CD

Conducting a Search

Searching Directly

(Searching a Specified Track Number)

Press the NUMERIC (0 to 9) ⑨ to specify a track number.

Notes:

- Searching track number 3:
press the “3” button.
- Searching track number 12:
press the “1” button and then the “2” button.

Conducting a Skip Search

- Skipping to Next Track
press the ►► button ⑭.
- Skipping to Previous Track
press the ◀◀ button ⑫.

Tip:

- Press the ◀◀ button ⑫ while once playing a CD to send the player back to the beginning of the current track.

Using the Pitch Controls

PMD330 Only

The disc playback speed can be adjusted in 0.1% increments up to +/-12%.

Increasing the Disc Playback Speed

Procedure

1. Press the ►/|| button ⑰ to start playing a CD.
2. Press the PITCH ON/OFF button ⑳ to turn on the pitch control function.
3. Press the PITCH + button ㉑ to increase the disk playback speed by an increment of 0.1%.
4. Keep pressing the PITCH + button ㉑ to increase the playback speed continuously.
5. Press the PITCH ON/OFF button ⑳ quickly to return to normal speed.

Decreasing the Disc Playback Speed

Procedure

1. Press the ►/|| button ⑰ to start playing a CD.
2. Press the PITCH ON/OFF button ⑳ to turn on the pitch control function.
3. Press the PITCH - button ㉒ to decrease the disk playback speed by a decrement of 0.1%.
4. Keep pressing the PITCH - button ㉒ to decrease the playback speed continuously.
5. Press the PITCH ON/OFF button ⑳ quickly to return to normal speed.

Returning to the Normal Playback Speed

Press the PITCH ON/OFF button ⑳, and the playback speed returns to normal.

Notes:

- The right side of the pitch indicator ㉓ shows the positive pitch speed.
- The left side of the pitch indicator ㉓ shows the negative pitch speed.

Using the Pitch Controls

PMD331/PMD340 Only

The disc playback speed can be adjusted by a maximum of +/- 12% in 0.1% increments.

Tip:

When playing two CD players simultaneously, it is possible to use the pitch bend function on one player to easily adjust the playback speed so that both CD players are in unison.

Increasing the Disc Playback Speed

Procedure

1. Press the ►/|| button (17) to begin playing a CD.
2. Press the PITCH ON/OFF button (26) to turn on the pitch control function.
3. Turn PITCH/SEARCH DIAL (20) clockwise.
 - Turn the dial approximately 10 degrees to increase the playback speed by 0.1%.
 - PITCH/SEARCH DIAL (20) shows up to +12%.
4. While the PITCH BEND + (27) button is pressed, the playback speed increases temporarily by up to 8%.

Tip:

The disc playback speed changes rapidly when the **PITCH BEND +** (27) button is pressed. As soon as you release the button, the playback speed immediately returns to the speed that was in effect before the button was pressed.

Note:

If "D.OUT" has been set to "On" in the presets, the pitch bend function will not work.

Decreasing the Disc Playback Speed

Procedure

1. Press the ►/|| button (17) to begin playing a CD.
2. Press the PITCH ON/OFF button (26) to turn on the pitch control function.
3. Turn PITCH/SEARCH DIAL (20) to the counterclockwise.
 - Turn the dial approximately 10 degrees to decrease the playback speed by 0.1%.
 - The PITCH/SEARCH DIAL (20) shows up to -12%.
4. While the PITCH BEND - (28) button is pressed, the playback speed decreases temporarily by up to 8%.

Tip:

The disc playback speed changes rapidly when the **PITCH BEND -** (28) button is pressed. As soon as you release the button, the playback speed immediately returns to the speed that was in effect before the button was pressed.

Restoring the Normal Playback Speed

Procedure

1. Press the PITCH ON/OFF button (26) and the playback speed returns to normal.

Using the A-B Repeat Function

Using the A-B Repeat Function

Procedure

1. Press the ►/|| button (17) to begin playing a CD.
2. While the CD is either playing or paused at the desired position, press the A-B button (25). The starting point is stored, and "A-" flashes.

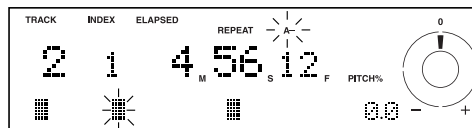

3. While the CD is either playing or paused at the desired position, press the A-B button (25). Point B is stored, and "A-B" lights.

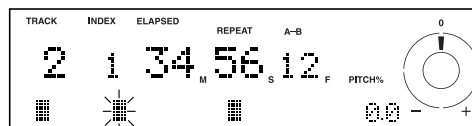

Playback starts from point A, and then the segment between points A and B plays repeatedly.

Clearing Points A and B

Pressing the A-B button (25) while A-B Repeat playback is in progress clears points A and B.

Tip:

Points A and B are cleared not only if the **A-B** button (25) is pressed, but also if the ■ button (12) is pressed (stopping playback), or if a scan search or direct search is performed.

Playback Using the Program Function

Registration

It is necessary to register the tracks to use the program function.

Procedure (For example, to store P-01, P-02.)

1. Press the ■ button (13) to stop playback and then press the PROG button (11).
2. Input the track number to be registered by pressing the numeric buttons (0 to 9) (9).

At this point, the ►/||/ENTER button (17) flashes.

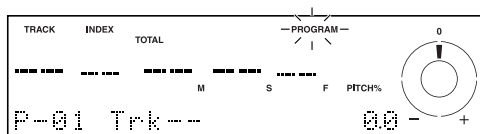
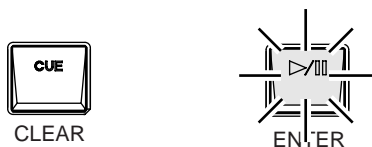

3. Press the ►/||/ENTER button (17).
The specified track number is registered in the program as "P-01".

Tip:

Input the track number within five seconds. If the track number is not input within five seconds, it is cancelled.

4. The program number then changes to "P-02".
5. Input the next track number to be registered by pressing the numeric buttons (0 to 9) (9).
6. Press the ►/||/ENTER button (17).
The specified track number is registered in program "P-02".
7. The program number then changes to "P-03".
8. When you have registered all the required tracks, press the PROG button (11) or the ■/EXIT button (13).
The CD player will then exit the program registration mode and enter the program play mode.

Tips:

- A maximum of 20 tracks can be registered in the program.
- To stop program registration, press the PROG button (11) or the ■/EXIT button (13).
- Program play can be switched off via the MODE menu.

To clear a registered Track

Procedure (For example, to clear P-02.)

1. Press the ■ button (13) to stop playback, and then press the PROG button (11).
2. The program number "P-01" is displayed.
At this point, the CUE/CLEAR button (15) flashes.

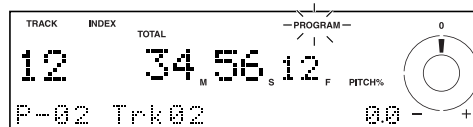

3. Press the ►► button (14), so that program number "P-02" is displayed.

Tip:

If the ►► button (14) is pressed, the program number that is displayed increases by one. If the ◀◀ button (12) is pressed, the program number that is displayed decreases by one.

4. Press the CUE/CLEAR button (15).
"P-02" is cleared and "P-02 Trk - -" is displayed on the display (6).

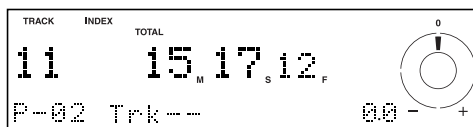

Switching Program Playback OFF

Procedure

1. Press the MODE button (22).
2. Select the playback mode so that "Program: On" is displayed in the character display portion of the display (5).
3. Press either the ◀◀ button (12) or the ►► button (14) to change the display to "Program: Off".
4. Press the ►/||/ENTER button (17) to confirm the setting.
5. Press the ■/EXIT button (13) to exit the playback mode menu.
6. When the ►/|| button (17) is pressed, normal playback begins.

Playback Using the CUE Function

Setting the CUE Point

Procedure (Setting)

1. Press the ►/|| button (17) to begin playing a CD.

Tip:

It is possible to use the search, skip scan or direct search functions to find the approximate position from where you wish to begin playback.

2. Press the ►/|| button (17) to pause the disc at the approximate position from where you wish to mark the CUE point.
3. Use the ◀◀ button (16) and the ▶▶ button (18) to search for the exact position from where you wish to mark the CUE point. Use the ◀◀ button (16) to reverse one frame and then pause. Use the ▶▶ button (18) to advance one frame and then pause. If you hold down either the ◀◀ button (16) or the ▶▶ button (18), the rate at which the frames reverse or advance changes while the button is being held down.

Tip: (PMD331/PMD340 only)

It is also possible to use the PITCH/SEARCH dial (20) to find the exact position.

4. Press the CUE button (15) to store the CUE point. The CUE point is set at this position. At this point, the CUE button (15) stops flashing and remains lit. "CUE Stored" appears on the display.

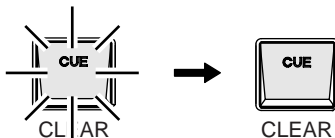

Checking the CUE Point

Procedure

1. Press the CUE button (15). The CD player immediately moves to the CUE point, and pauses there.
2. Hold down the CUE button (15). Playback starts from the CUE point. Playback stops when the CUE button (15) is released, and then the CD player returns to the CUE point and pauses.

Tips:

- Once a cue point has been set, the CD player plays while holding the CUE button (15). Playback returns to the cue point when released.

The concept of CUE play is illustrated below.

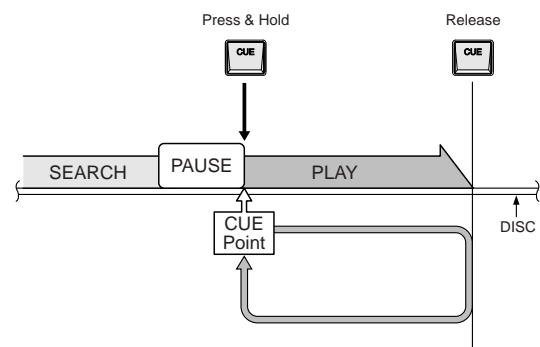

- When the player is in CUE playback mode (CUE button held down), it is easy to change to normal playback by also pressing shortly the ►/|| button (17). Both the CUE and the ►/|| button (17) can be released now and the player will continue playback.

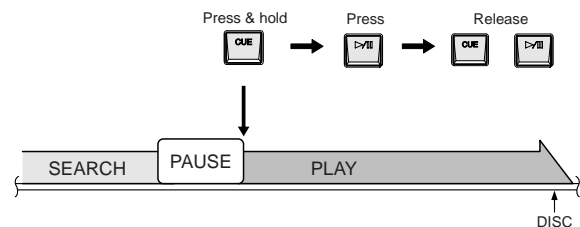

Playback Using the CUE Function

Beginning playback from the CUE point

Procedure (Playback)

1. Press the **CUE** button (15).
The CD player immediately moves to the CUE point, and pauses there.
2. Press the **▶/||** button (17). Playback starts from the CUE point.

PMD331/PMD340 only:

If the CD player is in the paused state and the **▶/||** button (17) is pressed, playback from the CUE point starts without any delay. This function is called "Instant Start."

Tip:

It is easy to return to the CUE point after the point has been set. The concept of CUE play is illustrated below.

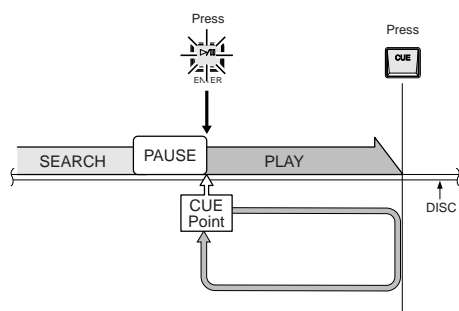

Erasing the CUE Point

Procedure (Erase)

1. Press the **■** button (13) to stop playback, and then press the **■** button (13) again to erase the cue point. If the cue point is erased, the **CUE** button (15) turns off.

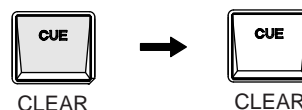

Note:

The CUE point is also erased if you press the **▲** button (6) to open the **disc tray** (2), or if you press the **POWER** switch (1) and turn the CD player off.

Resetting the CUE Point

Repeat the procedure described on page 12 in "Setting the CUE Point," starting from step 1.

If the CD player is kept in the paused state for an extended Period of time

If the CD player is left in the paused state for an extended period of time without performing any operations, it automatically enters the "auto standby" state.

In the auto standby state, the disc stops and "Standby" is indicated on the display.

To release the CD player from the auto standby state, press the **▶/||** button (17).

When you press the **▶/||** button (17), the CD player searches for the position that it was at previously and then pauses.

If you press the **CUE** button (15) while the CD player is in the auto standby state, it searches for the CUE point and then pauses there.

Tip:

The amount of time the unit waits before it enters the "auto standby" state can be selected in the preset menu: 30 minutes (initial value), 20 minutes, 10 minutes, or 30 seconds.

Playback Modes

Setting the Playback Mode

Procedure

1. Press the **MODE** button (22).
The **▶/II/ENTER** button (17) lights.
One of the playback modes and the current setting appear on the display (E).

Tip:

For the items that can be set in playback mode, refer to the Playback Mode Chart.

2. Press the **MODE** button (22) in order to scroll through the playback modes.

Tip:

It is also possible to scroll through the items in the playback mode menu by pressing the **INDEX+** button (24) or the **INDEX-** button (21).

3. Use the **◀◀** button (12) or the **▶▶** button (14) to change the setting of the displayed mode.
At this point, the **▶/II/ENTER** button (17) changes from being steadily lit to flashing.

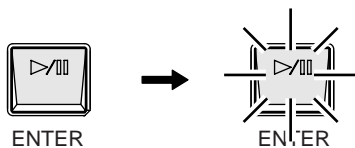

4. Press the **▶/II/ENTER** button (17) to confirm the change.
At this point, the **▶/II/ENTER** button (17) changes from being flashing to steadily lit.

Tip:

Press the **CUE/CLEAR** button (15) to cancel a change before it is confirmed.

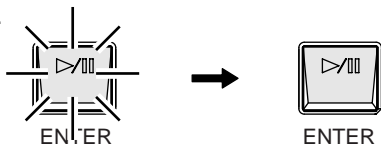

5. Press the **■/EXIT** button (13) to exit the setting menu and return to the stopped state.

Playback Mode Chart

Functions, LCD Display, and Initial Values

NO.	Function	Playback mode (LCD display)	Setting items	
			Initial value(bold)	
1	Selects the operation when playback of a single track ends.	Single:	Off	Cue Stop On
2	Selects whether to use program playback or not.	Program:	Off	On
3	Selects whether to use random playback or not.	Random:	Off	On
4	Selects whether to repeat playback or not.	Repeat:	Off	1 All Single track repeat All track repeat

Tips:

- This CD player is equipped with a “power-on auto repeat playback” function.

The “**power-on auto repeat playback**” function begins playing automatically if the CD player is turned on while there is a CD in the disc tray.

In order to use the “**power-on auto repeat playback**” function, you must make the following two settings beforehand:

- 1) Select “**Single:Off**” for play back mode function No.1.
- 2) Select “**Repeat:All**” for playback mode function No.4.
- 3) Select “**Auto Cue:Off**” for preset function No.1.
- 4) Select “**Start:Play**” for preset function No.13.

- The playback mode that is currently set is stored in memory, and becomes the initial setting the next time that the power is turned on.

If there is a disc in the tray, playback begins automatically in “all track repeat” mode when the power is turned on.

Note:

If you have set “**Yes**” for “**Reset?**” in the preset menu, the initial value for the playback mode is also restored.

Checking the Playback Mode

Procedure

Pressing the **MODE** button (22) causes the various playback modes to be displayed on the screen.

Tip:

The following playback modes can be selected in combination: single-track playback (“**Single**”), program playback (“**Program**”), random playback (“**Random**”) and repeat playback (“**Repeat**”).

Synchro Recording

Using Synchro Recording

This CD player has a CD SYNC function that makes it easy to record for this CD player to be used in combination with a cassette recorder.

- The CD SYNC function works in combination with a cassette deck that is equipped with the synchro recording function.
- Connect the remote control jack (RC5) output [5] on this CD player to the (RC5) input on the cassette deck, and then prepare the cassette deck for synchro recording. Refer to figure 2 for the connection method.

Procedure

1. Put the cassette recorder into the synchro recording mode.
2. With the CD player in the stopped state, press the ►/⏸ button [17] to start playing the CD. The cassette recorder automatically begins recording.

3. When the CD player finishes playing, it stops and the cassette recorder enters the paused state.
4. To continue recording, repeat this procedure, starting from step 2.

Tips:

- When performing synchro recording with a non-cassette recorder, such as a CD-R or CD-RW recorder, the operation may differ, so check the instruction manual provided with your recorder.
- When performing synchro recording, set preset menu No.17 "CD sync" to "On".
- Make sure to set preset menu item No.1 "Auto Cue" to "Off" and No.13 "Start" to "Play" or "Stop" before utilizing CD Sync function. (See also page 17.)

Using a Remote Control (Not Included)

- This CD player can receive signals directly from an infrared remote control transmitter within about 5 meters (15 feet.) Note that the CD player might not operate correctly if the remote control transmitter is not pointed in the direction of the sensor on the CD player, or if there is an obstacle between the transmitter and the sensor.

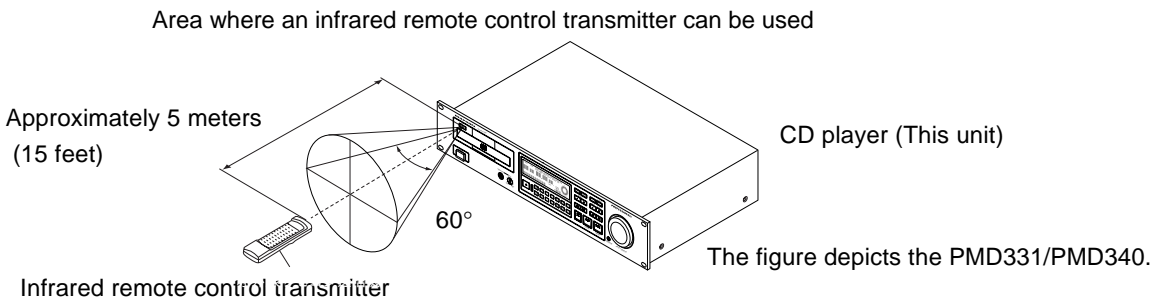

- This CD player can be controlled through its infrared **sensor** [29] on the front panel when it receives remote control signals that supports RC5 signals as shown in the table at right. These remote control codes can also be used if sent through the RC5 **remote control jack** [5] found on the rear panel of the CD player.

Tip:

Because the infrared remote **sensor** [29] on the front panel of the CD player and the **RC5 remote control input jack** on the rear panel of the CD player both support the RC5 codes listed in the table at right, this CD player can be controlled through the infrared remote control sensor of any device that supports RC5 codes.

RC5 Code chart

	Command	Cord		Command	Cord
INPUT	Play	2053	INPUT	Mode	2036-10
	Pause	2048		Preset	2041-12
	Cue	2059-10		END monitor	2043-10
	Stop	2054		CD-TEXT	2088
	FF	2052		0	2000
	FR(REW)	2050		1	2001
	Index +	2034		2	2002
	Index -	2035		3	2003
	Next	2032		4	2004
	Previous	2033		5	2005
	Pitch +	2038		6	2006
	Pitch -	2039		7	2007
	Pitch Bend +	2038-10*		8	2008
	Pitch Bend -	2039-10*		9	2009
	A - B	2059		OUTPUT	CD Sync start
Program	2041	CD Sync stop	1857		
Pitch On/Off	2037				
Open/Close	2045				
Time	2011				

* Remote control codes that are marked with an asterisk are not supported by the PMD330.

CD-TEXT Information Display

Text information that is stored on a CD-TEXT disc can be displayed in the sequence shown below by pressing the TEXT button ⑧.

However, because the information that is recorded differs for each disc, it is possible that not all of the information listed below can be displayed.

This CD player automatically skips any items that are not recorded on the disc.

Tip:

Discs that support CD-TEXT are labeled with the  mark.

Note:

If a disc contains no CD-TEXT information, the message "No CD-TEXT" is displayed when the TEXT button ⑧ is pressed.

When stopped

The TEXT button ⑧ can be pressed to cycle through the items shown below.

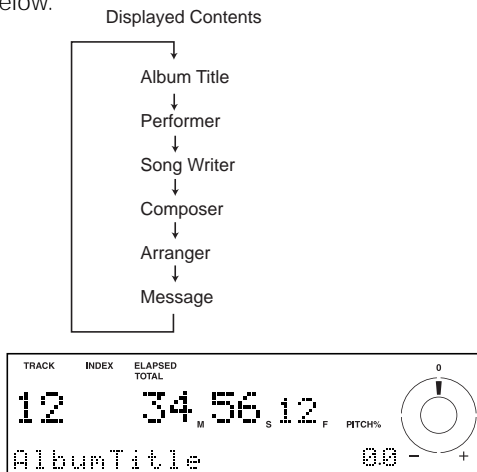

During playback

The TEXT button ⑧ can be pressed to cycle through the items shown below. The information that is displayed pertains to the track that is currently playing.

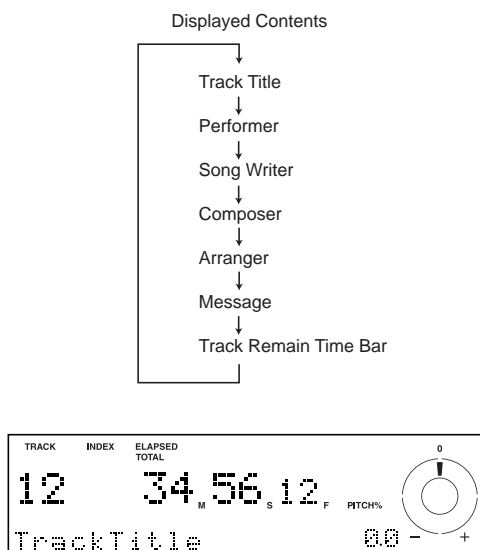

Using the Preset Menu

Changing the Preset Settings

Procedure

1. Press the ■ button 13 to put the CD player in the stopped mode.
2. Press the PRESET button 10.
The ►/II/ENTER button 17 light.
3. An item that can be set as a preset appears on the display ⑤. (Refer to the Preset menu table for a list of these items.)
4. Press the PRESET button 10 in order to scroll through the preset items.

Tip:

It is also possible to scroll through the items by pressing the INDEX+ button 24 or the INDEX- button 21.

5. Use the ◀◀ button 12 or the ▶▶ button 14 to change the setting of the displayed preset. At this point, the ►/II/ENTER button 17 changes from being steadily lit to flashing.

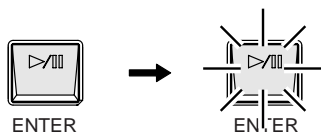

6. Press the ►/II/ENTER button 17 to confirm the selection. At this point, the ►/II/ENTER button 17 changes from being flashing to steadily lit.

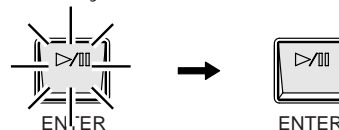

Tip:

Press the CUE/CLEAR button 15 to cancel a setting before it is confirmed.

Note:

If "D.OUT" is set to "On," the instant start, shockproof, and pitch bend functions will not work.

Preset Menu Chart: Functions, LCD Display, and Initial Values

No.	Presetting items / Function	LCD Display	The settings shown in (bold) are the initial settings.							
1	Selects the Auto Cue function. If this item is set to "On", the CD sync function will not work.	Auto Cue:	On		Off					
2	Selects the sound level at which the Auto Cue function operates.	AC Lev:	- 40dB , - 90dB to - 35dB in 5dB Steps							
3	Selects the End Monitor playing time.	END Mon:	5s	10s	15s	20s	25s	30s	35s	
4	Selects the time at which END starts to flash.	END Warn:	0s	5s	10s	15s	20s	25s	30s	35s
5	Selects the fade-in time.	FadeIn:	0s to 8.0s in 0.5s Steps							
6	Selects the fade-out time.	FadeOut:	0s to 8.0s in 0.5s Steps							
7	Selects the delay when going from paused to the start of playing.	Delay:	0ms	100ms	200ms	300ms	400ms			
8	Selects the time display mode when the power is turned on.	Time:	Trk REM Track Remain	Trk ELP Track Elapsed	Dsc REM Disc Remain	Dsc ELP Disc Elapsed	Dsc TTL Disc Total			
9	Enables/disables key lock. When key lock is "On", only the POWER ① and PRESET ⑩ buttons function.	KeyLock:	Off			On				
10	Selects whether to enable or disable control buttons during playback that was initiated using "fader start." During playback, only the POWER ①, TIME ⑦ and TEXT ⑧ buttons can be used. All buttons can be used when playback is paused.	FaderLok:	Off			On				
11	Enables/disables the OPEN/CLOSE button while playing.	TrayLock:	On			Off				
12	Selects the auto close time for the disc tray.	AutoCLS:	Off	10s	30s	60s	180s			
13	Selects the operation that is performed after a disc is loaded in the disc tray and after a track is selected. Refer to page 7 for a complete explanation of each setting.	Start:	Pause		Play	Stop				
14	Selects the wait time before the CD player enters auto standby.	AutoSTBY:	30m	20m	10m	30sec				
*15	Selects whether to output digital signals or not. If this item is set to "ON," the instant start, shockproof, and pitch bend functions will not work.	D.OUT:	Off			On				
16	Enables/disables the Control I/O (D-sub 25-pin) ⑩ input jack (PMD331/PMD340) or the fader start input jack (PMD330) ③.	Remote:	On			Off				
17	Enables/disables the CD Sync function. Selects whether to output the CD Sync signal through the RC5 jack ⑤ when playback starts. Turn Auto Cue (preset #1) "Off" to utilize the CD sync function.	CD Sync:	Off			On				
*18	Selects which Index (#2 or #3) will trigger an output on pin #11 on the Control I/O Port.	Index:	#2			#3				
19	Selects whether or not to display a warning when a skip occurs as a result of a bad CD.	Alert:	Off			On				
20	Selects the CD-TEXT display language.	Text:	English	French	Spanish	German				
21	Selects whether or not to restore the original presets.	Reset?:	No			Yes				

* Those items marked with an asterisk can only be selected on the PMD331/PMD340. They are not displayed on the PMD330.

Using the Control Port (PMD331/PMD340 Only)

The control port is an input/output jack for remote control (D-SUB 25-pin female connector). Different contact circuits (switches, etc.) can be connected to each input.

In addition, the CD player can be monitored or can provide control to a remote location by using to the output jacks.

Notes:

- The maximum output current on pin 12 (Tally power supply) is 80 mA.
- Use a D-sub 25-pin male connector. (Threaded portion: 4-40 UNC)
- When connecting such a connector, refer to the connection examples illustrated below.

Tip:

- To enable the input from the control I/O jack, set preset menu No. 16 "Remote" to "On". (See also page 17.)

Table of Control Input/Output Signals

Pin No.	Signal name	I/O	Function	Port specification
1	PLAY TALLY	O	On while playing	TTL (Ii < 20 mA)
2	PAUSE TALLY	O	On while paused	TTL (Ii < 20 mA)
3	CUE TALLY	O	Equivalent to CUE LED	TTL (Ii < 20 mA)
4	STOP	I	Equivalent to STOP button	HCMOS
5	FR	I	Equivalent to ◀◀ button	HCMOS
6	INDEX -	I	Equivalent to INDEX -	HCMOS
7	PREVIOUS	I	Equivalent to ◀◀ button	HCMOS
8	PITCH +	I	Equivalent to PITCH +	HCMOS
9	PITCH ON/OFF	I	Equivalent to PITCH button	HCMOS
10	FADER (NORMAL)	I	See also page19	HCMOS
11	INDEX#2/INDEX#3	O	Output when switching between INDEX#2 and INDEX#3	TTL (Ii < 20 mA)
12	TALLY POWER SUPPLY	-	TALLY power supply	+5V, I max = 80 mA
13	FG COMMON	-	Frame GND	_____
14	PLAY	I	Causes the CD player to play	HCMOS
15	PAUSE	I	Causes the CD player to pause	HCMOS
16	CUE	I	Equivalent to CUE button	HCMOS
17	FF	I	Equivalent to ▶▶ button	HCMOS
18	INDEX +	I	Equivalent to INDEX + button	HCMOS
19	NEXT	I	Equivalent to ▶▶ button	HCMOS
20	END	I	Equivalent to END button	HCMOS
21	PITCH -	I	Equivalent to PITCH - button	HCMOS
22	FADER TALLY	O	On during fader playback	TTL (Ii < 20 mA)
23	FADER (INVERT)	I	See also page19	HCMOS
24	END TALLY	O	Equivalent to END LED	TTL (Ii < 20 mA)
25	TALLY COMMON	-	TALLY GND	_____

Parallel Control Input/Output Connection Examples

When using pin 10 FADER (NORMAL)

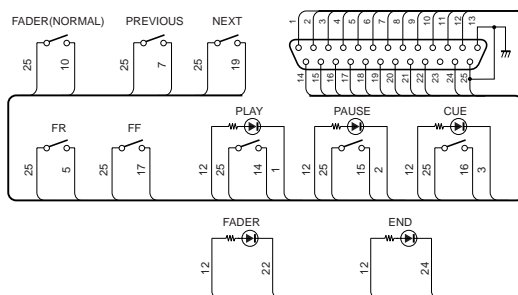

When using pin 23 FADER (INVERT)

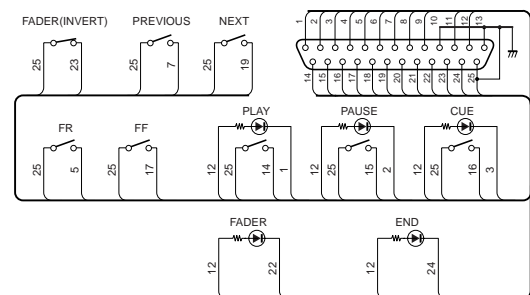

Fader Start

The Fader Start input can be used to play or pause the CD player by connecting it to a mixer or mixing console equipped with a fader start output. A customized switch can also be created for applications where a fader start output is not available.

Tip:

To enable the input from the fader switch, set preset menu No.16 “Remote:” to “On”. (See also page 17)

Connection to the PMD330

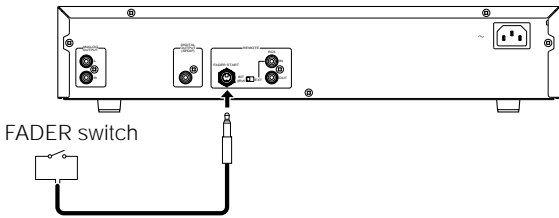

Fader start polarity	
Play	Closed
Pause	Open

Connection to the PMD331/PMD340

When using control port pin 10 FADER (NORMAL) and pin 25 (TALLY COMMON)

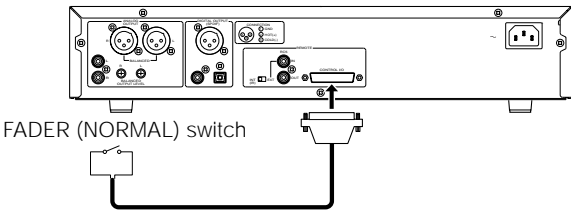

Fader start polarity	
Play	Closed
Pause	Open

Connection to the PMD331/PMD340

When using control port pin 23* FADER (INVERT) and pin 25 (TALLY COMMON)

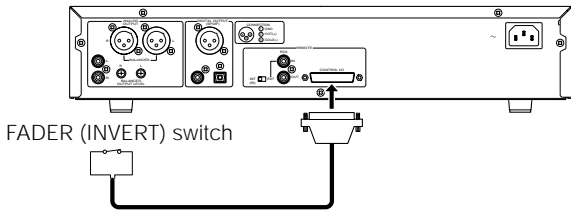

Fader start polarity	
Play	Open
Pause	Closed

Troubleshooting

The following is the troubleshooting list. Sometimes, an unintentional mistake in the operation of the CD player could lead you to think that it was malfunctioning.

This device contains a microcomputer chip. If you suspect that static electricity may have caused the CD player to operate incorrectly, turn the power off, wait at least thirty seconds, and then turn the power back on.

The disc does not play.

1. Is the power cord connected properly?
2. Is the POWER switch on?
3. Is the disc positioned correctly?
4. Is the disc right side up? (The disc label should be facing up.)
5. Is the disc dirty?
6. Is the disc damaged?
7. Is the disc warped?

The disc play, but there is no sound.

1. Are the amp and speakers connected properly?
2. Is the amp power switch on?
3. Is the amp function or selector switch set to “CD” or “AUX” (whichever corresponds to the jacks to which you connected the CD player)?
4. Is the amp volume set properly?

The disc suddenly stops.

1. Is the disc dirty?
2. Is the disc damaged?
3. Is the disc warped?

There is no sound at all, or there is sudden noise during the music.

1. Is the disc dirty or damaged?
2. Is the disc warped?
3. Is the CD an audio CD? This CD player cannot play personal computer CD-ROMs or DTS-CDs, etc.

The remote control does not work.

1. Is the window on the remote control transmitter pointing properly at the sensor on the CD player? Is there an obstacle between the remote control transmitter and the CD player?
2. Are the batteries in the remote control still in good condition?
3. Is there a strong light source shining on the remote control sensor?
4. Is the INT/EXT switch set to INT?

The CD player will not play a CD-R/CD-RW disc.

1. Is the disc right side up? (The disc label should be facing up.)
2. Has the disc been properly finalized (i.e., was the TOC written on the disc)?
3. Is the data recorded on the disc in a audio (CD-DA) format?

* When using control port pin 23 FADER (INVERT), pin 10 FADER (NORMAL) must be connected to pin 13 (FG COMMON) of the port.

Specifications

		PMD330	PMD331/PMD340
General specifications			
System		Compact Disc - Digital Audio	
Number of channels		2	
Compatible discs		CD-DA, CD-R, CD-RW (12 cm,8 cm)	
Audio characteristics			
Channels		2 channels	
Frequency characteristics		20 Hz to 20 kHz +/- 0.3dB	
Dynamic range		≥ 90 dB (1kHz)	
S/N ratio		≥ 100 dB (1kHz)	
Total harmonic distortion (THD)		0.005% (1kHz)	
Wow and flutter		Quartz precision	
Error correction method		Cross-interleave Read-Solomon code (CIRC)	
Analog output	Pin jack,unbalanced (RCA)	2.0V RMS Stereo	
	XLR jack,balanced (XLR) (variable range)	— —	+16dBu /600Ω, @ 0dB FS (-11dBu to +21dBu,variable)
Digital output	Pin jack (SPDIF)	0.5 Vp-p/75 Ω	
	XLR jack (SPDIF)	—	3.5 Vp-p/110 Ω
	optical connector	—	-19 dBm
Search precision		1 frame	
Pitch control		Maximum: +/-12% in 0.1% steps	
Pitch bend control		—	+/- 8%
Strat timing		—	20 ms
Remote control			
Infrared remote control input		IN (IR sensor)	
RC5 remote control input/output		—	RCA IN (INT/EXT switch)/OUT
Remote control input/output		—	D-SUB 25-Pin female
Optical anning method			
Laser		AlGaAs semiconductor	
Wavelength		780nm	
Signal system			
Sampling frequency		44.1kHz	
Quantization		16-bit linear/channel	
Power supply section			
AC power supply		120V, AC 60Hz	
Power consumption		12 W	17 W
Cabinet, etc.			
External dimensions (W x H x D)		483 x 100 x 325 mm (19 x 3-15/16 x 12- 13/16 inches)	
Weight		4.8 kg (10.6 lbs)	4.9 kg (10.8 lbs)
Operating temperature range		+ 5°C to + 35°C	
Operating humidity range		5% to 90% (without dew)	

Due to our continuing efforts to improve our products, the specifications and appearance of this product are subject to change without prior notice.

Figures

Rear and Front Views of the PMD330

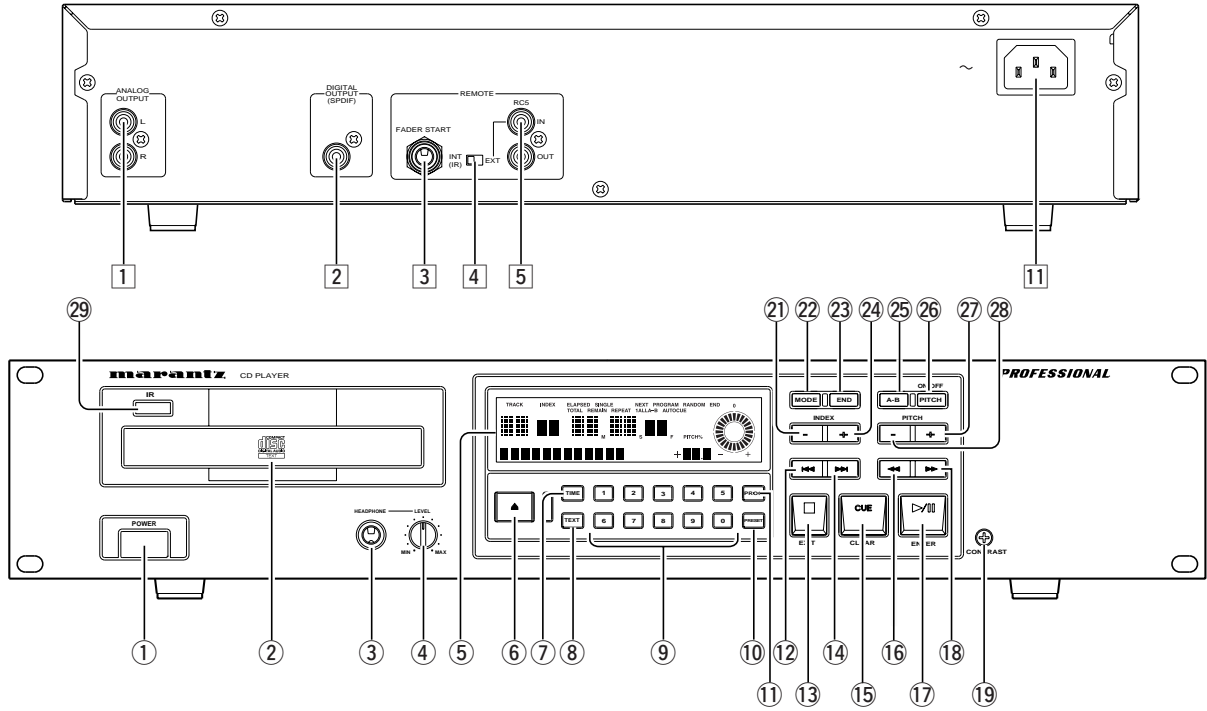

Rear and Front Views of the PMD331/PMD340

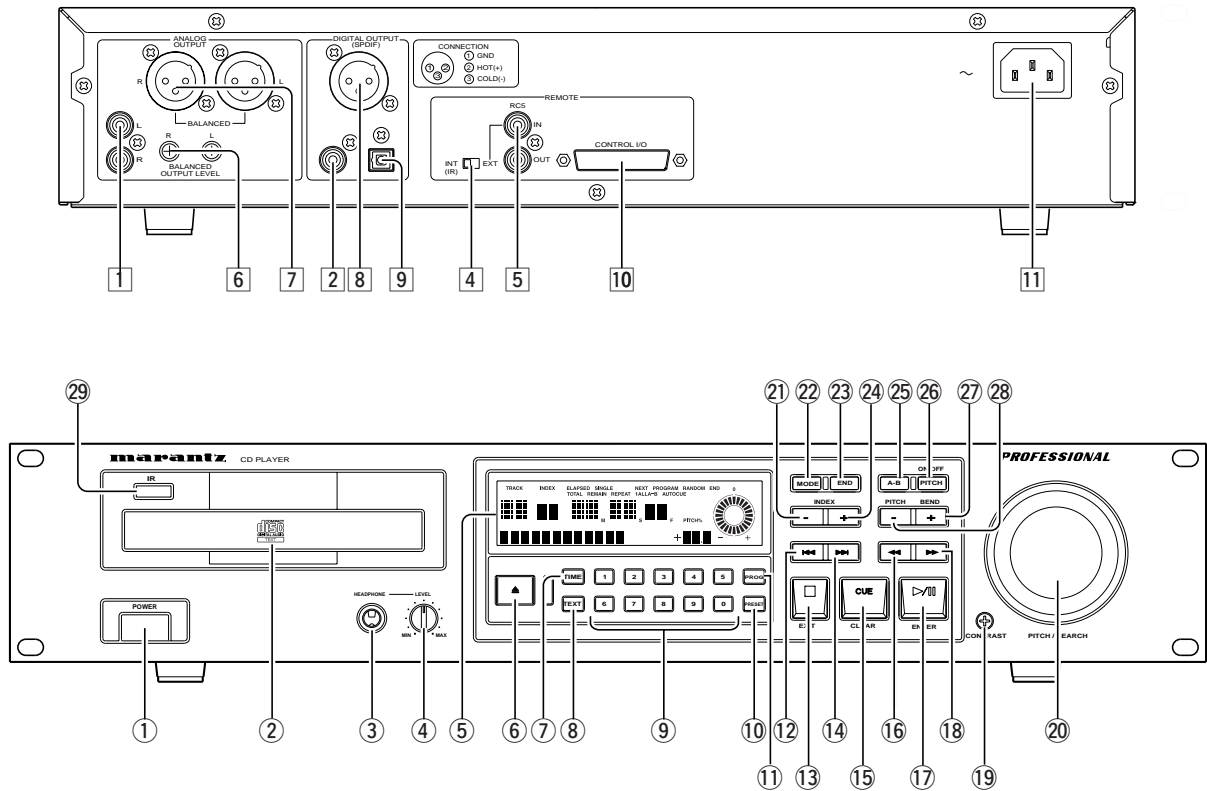
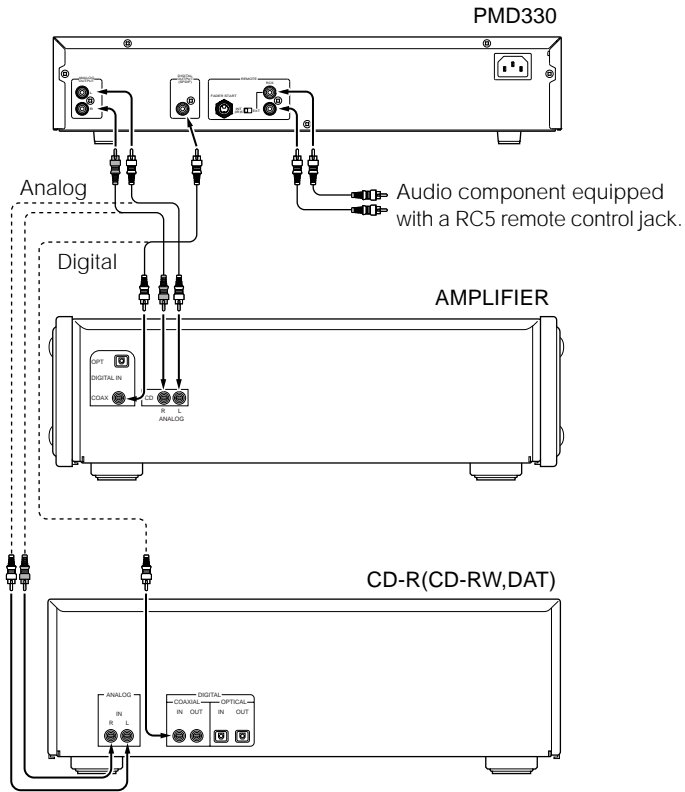

Figure 1

Connection

PMD330



PMD331/PMD340

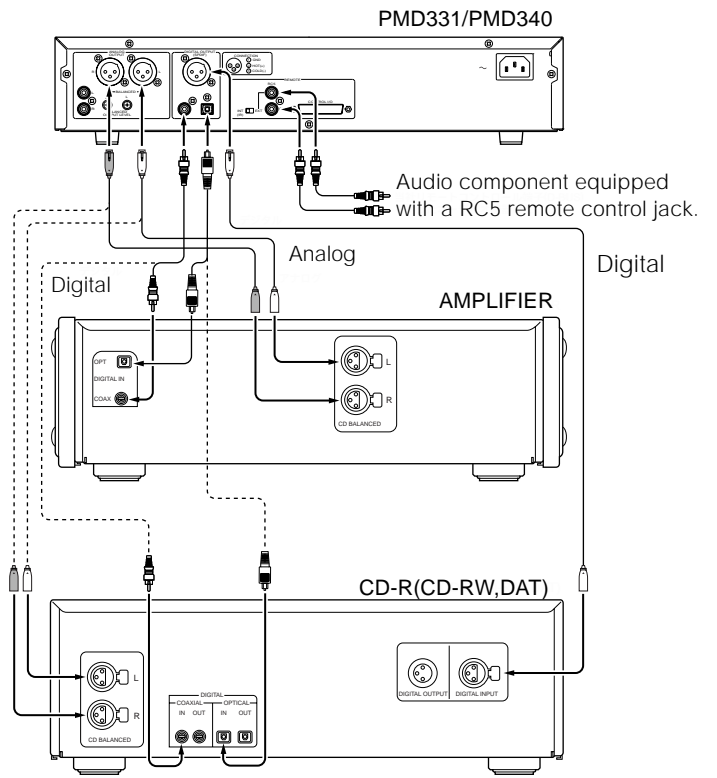

Figure 2

External Dimensions

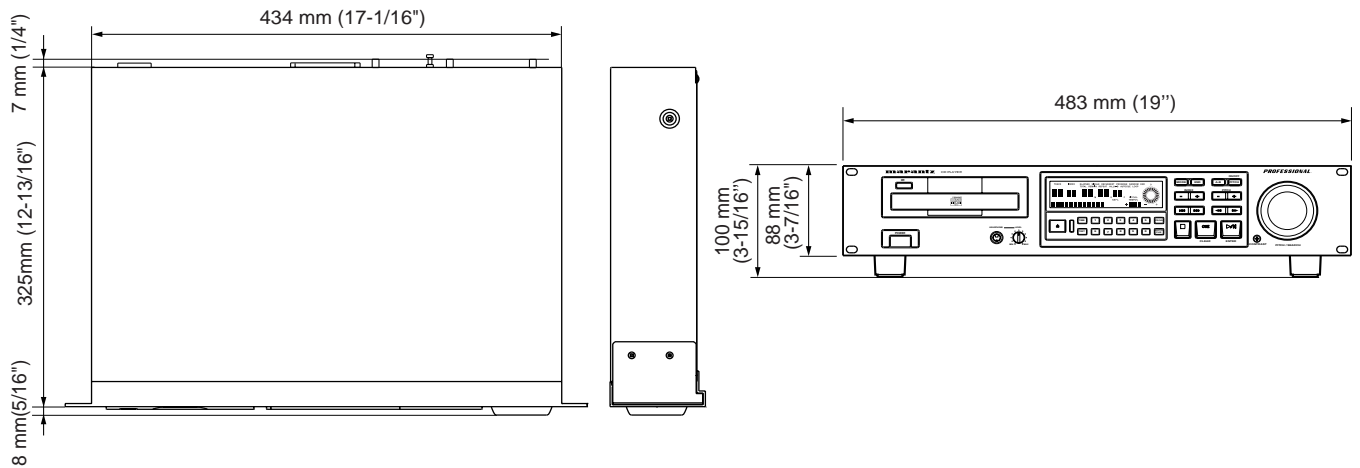

Figure 3

marantz[®] is a registered trademark.

