

DENON

MINIDISC RECORDER

DN-M991R

OPERATING INSTRUCTIONS

BEDIENUNGSANLEITUNG

MODE D'EMPLOI

INSTRUCCIONES DE OPERACION

BRUKSANVISNING

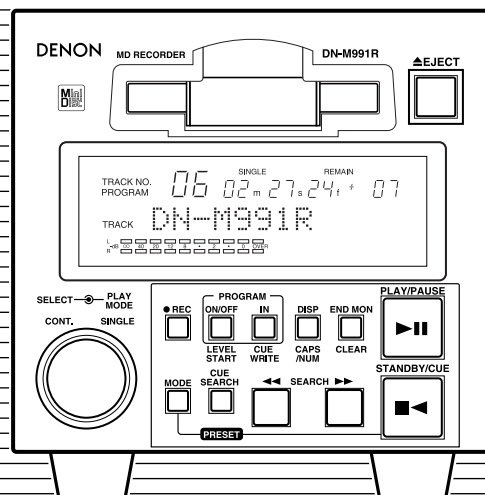

| | | | |
|----------------------------|--------|--------------|-----|
| FOR ENGLISH READERS | PAGE | 6 ~ PAGE | 41 |
| FÜR DEUTSCHE LESER | SEITE | 42 ~ SEITE | 78 |
| POUR LES LECTEURS FRANCAIS | PAGE | 77 ~ PAGE | 114 |
| PARA LECTORES DE ESPAÑOL | PAGINA | 115 ~ PAGINA | 150 |
| FÖR SVENSKA LÄSARE | SIDA | 151 ~ SIDA | 186 |

IMPORTANT TO SAFETY

WARNING:

TO PREVENT FIRE OR SHOCK HAZARD, DO NOT EXPOSE THIS APPLIANCE TO RAIN OR MOISTURE.

CAUTION:

1. Handle the power supply cord carefully

Do not damage or deform the power supply cord. If it is damaged or deformed, it may cause electric shock or malfunction when used. When removing from wall outlet, be sure to remove by holding the plug attachment and not by pulling the cord.

2. Do not open the top cover

In order to prevent electric shock, do not open the top cover. If problems occur, contact your DENON dealer.

3. Do not place anything inside

Do not place metal objects or spill liquid inside the MD recorder. Electric shock or malfunction may result.

Please, record and retain the Model name and serial number of your set shown on the rating label.

Model No. DN-M991R

Serial No. _____



CAUTION
RISK OF ELECTRIC SHOCK DO NOT OPEN



CAUTION: TO REDUCE THE RISK OF ELECTRIC SHOCK, DO NOT REMOVE COVER (OR BACK). NO USER-SERVICEABLE PARTS INSIDE. REFER SERVICING TO QUALIFIED SERVICE PERSONNEL.



The lightning flash with arrowhead symbol, within an equilateral triangle, is intended to alert the user to the presence of uninsulated "dangerous voltage" within the product's enclosure that may be of sufficient magnitude to constitute a risk of electric shock to persons.



The exclamation point within an equilateral triangle is intended to alert the user to the presence of important operating and maintenance (servicing) instructions in the literature accompanying the appliance.

NOTE:

This MD recorder uses the semiconductor laser. To allow you to enjoy music at a stable operation, it is recommended to use this in a room of 5 °C (41 °F) ~ 35 °C (95 °F).

• FOR U.S.A. & CANADA MODEL ONLY

CAUTION

TO PREVENT ELECTRIC SHOCK DO NOT USE THIS (POLARIZED) PLUG WITH AN EXTENSION CORD, RECEPTACLE OR OTHER OUTLET UNLESS THE BLADES CAN BE FULLY INSERTED TO PREVENT BLADE EXPOSURE.

LABELS (for U.S.A. model only)

CERTIFICATION

THIS PRODUCT COMPLIES WITH DHHS RULES 21 CFR SUBCHAPTER J APPLICABLE AT DATE OF MANUFACTURE.

CAUTION:

USE OF CONTROLS OR ADJUSTMENTS OR REFORMATION OF PROCEDURES OTHER THAN THOSE SPECIFIED HEREIN MAY RESULT IN HAZARDOUS RADIATION EXPOSURE.

THE COMPACT DISC PLAYER SHOULD NOT BE ADJUSTED OR REPAIRED BY ANYONE EXCEPT PROPERLY QUALIFIED SERVICE PERSONNEL.

This device complies with Part 15 of the FCC Rules. Operation is subject to the following two conditions : (1) This device may not cause harmful interference, and (2) this device must accept any interference received, including interference that may cause undesired operation.

This Class B digital apparatus meets all requirements of the Canadian Interference-Causing Equipment Regulations.

Cet appareil numérique de la classe B respecte toutes les exigences du Règlement sur le matériel brouilleur du Canada.

CLASS 1 LASER PRODUCT
LUOKAN 1 LASERLAITE
KLASS 1 LASERAPPARAT

"CLASS 1
LASER PRODUCT"

ADVARSEL: OSYNLIG LASERSTRÅLING VED ÅBNING, NÅR SIKKERHEDSAFBRYDERE ER UDE AF FUNKTION. UNDGA UDSAETTELSE FOR STRÅLING.

VAROITUS! LAITTEEN KÄYTTÄMINEN MUULLA KUIN TÄSSÄ KÄYTTÖOHJEESSA MAINITULLA TAVALLA SAATTAA ALTISTAA KÄYTTÄJÄN TURVALLISUUSLUOKAN 1 YLITTÄVÄLLE NÄKYMÄMTTÖMÄLLE LASERSÄTEILYLLE.

VARNING- OM APPARATEN ANVÄNDS PÅ ANNAT SÄTT ÄN I DENNA BRUKSANVISNING SPECIFICERATS, KAN ANVÄNDAREN UTSÄTTAS FÖR OSYNLIG LASERSTRÅLNING SOM ÖVERSKRIDER GRÄNSEN FÖR LASERKLASS 1.

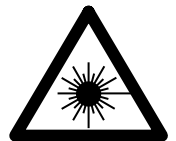

• POUR LES MODELES AMERICAINS ET CANADIENS UNIQUEMENT

ATTENTION

POUR PREVENIR LES CHOCS ELECTRIQUES NE PAS UTILISER CETTE FICHE POLARISEE AVEC UN PROLONGATEUR UNE PRISE DE COURANT OU UNE AUTRE SORTIE DE COURANT, SAUF SI LES LAMES PEUVENT ETRE INSEREES A FOND SANS EN LAISSER AUCUNE PARTIE A DECOUVERT.

SAFETY INSTRUCTIONS

1. Read Instructions – All the safety and operating instructions should be read before the appliance is operated.
2. Retain Instructions – The safety and operating instructions should be retained for future reference.
3. Heed Warning – All warnings on the appliance and in the operating instructions should be adhered to.
4. Following Instructions – All operating and use instructions should be followed.
5. Water and Moisture – The appliance should not be used near water – for example, near a bathtub, washbowl, kitchen sink, laundry tub, in a wet basement, or near a swimming pool, and the like.
6. Carts and Stands – The appliance should be used only with a cart or stand that is recommended by the manufacturer.
- 6A. An appliance and cart combination should be moved with care. Quick stops, excessive force, and uneven surfaces may cause the appliance and cart combination to overturn.
7. Wall or Ceiling Mounting – The appliance should be mounted to a wall or ceiling only as recommended by the manufacturer.
8. Ventilation – The appliance should be situated so that its location or position does not interfere with its proper ventilation. For example, the appliance should not be situated on a bed, sofa, rug, or similar surface that may block the ventilation openings; or, placed in a built-in installation, such as a bookcase or cabinet that may impede the flow of air through the ventilation openings.
9. Heat – The appliance should be situated away from heat sources such as radiators, heat registers, stoves, or other appliances (including amplifiers) that produce heat.
10. Power Sources – The appliance should be connected to a power supply only of the type described in the operating instructions or as marked on the appliance.
11. Grounding or Polarization – Precautions should be taken so that the grounding or polarization means of an appliance is not defeated.



12. Power-Cord Protection – Power-supply cords should be routed so that they are not likely to be walked on or pinched by items placed upon or against them, paying particular attention to cords at plugs, convenience receptacles, and the point where they exit from the appliance.
14. Cleaning – The appliance should be cleaned only as recommended by the manufacturer.
15. Power Lines – An outdoor antenna should be located away from power lines.
16. Outdoor Antenna Grounding – If an outside antenna is connected to the receiver, be sure the antenna system is grounded so as to provide some protection against voltage surges and built-up static charges. Article 810 of the National Electrical Code, ANSI/NFPA 70, provides information with regard to proper grounding of the mast and supporting structure, grounding of the lead-in wire to an antenna-discharge unit, size of grounding conductors, location of antenna-discharge unit, connection to grounding electrodes, and requirements for the grounding electrode. See Figure A.
17. Nonuse Periods – The power cord of the appliance should be unplugged from the outlet when left unused for a long period of time.
18. Object and Liquid Entry – Care should be taken so that objects do not fall and liquids are not spilled into the enclosure through openings.
19. Damage Requiring Service – The appliance should be serviced by qualified service personnel when:
 - A. The power-supply cord or the plug has been damaged; or
 - B. Objects have fallen, or liquid has been spilled into the appliance; or
 - C. The appliance has been exposed to rain; or
 - D. The appliance does not appear to operate normally or exhibits a marked change in performance; or
 - E. The appliance has been dropped, or the enclosure damaged.
20. Servicing – The user should not attempt to service the appliance beyond that described in the operating instructions. All other servicing should be referred to qualified service personnel.

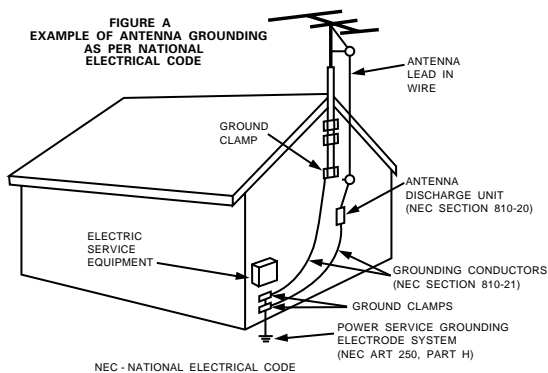

**NOTE ON USE / HINWEISE ZUM GEBRAUCH / OBSERVATIONS RELATIVES A L'UTILISATION
NOTE SULL'USO / NOTAS SOBRE EL USO / ALVORENS TE GEBRUIKEN / OBSERVERA
OBSERVAÇÕES QUANTO AO USO**

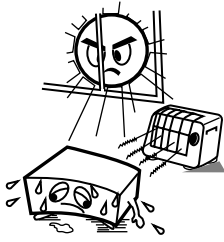

- Avoid high temperatures. Allow for sufficient heat dispersion when installed on a rack.
- Vermeiden Sie hohe Temperaturen. Beachten Sie, daß eine ausreichend Luftzirkulation gewährleistet wird, wenn das Gerät auf ein Regal gestellt wird.
- Eviter des températures élevées. Tenir compte d'une dispersion de chaleur suffisante lors de l'installation sur une étagère.
- Evitate di esporre l'unità a temperature alte. Assicuratevi che ci sia un'adeguata dispersione del calore quando installate l'unità in un mobile per componenti audio.
- Evite altas temperaturas. Permite la suficiente dispersión del calor cuando está instalado en la consola.
- Vermijd hoge temperaturen. Zorg voor een degelijk hitteafvoer indien het apparaat op een rek wordt geplaatst.
- Undvik höga temperaturer. Se till att det finns möjlighet till god värmeavledning vid montering i ett rack.
- Evite temperaturas altas. Conceda suficiente dispersão de calor quando o equipamento for instalado numa prateleira.

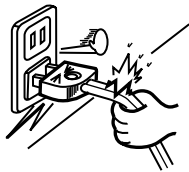

- Handle the power cord carefully. Hold the plug when unplugging the cord.
- Gehen Sie vorsichtig mit dem Netzkabel um. Halten Sie das Kabel am Stecker, wenn Sie den Stecker herausziehen.
- Manipuler le cordon d'alimentation avec précaution. Tenir la prise lors du débranchement du cordon.
- Maneggiare il filo di alimentazione con cura. Agite per la spina quando scollegate il cavo dalla presa.
- Maneje el cordón de energía con cuidado. Sostenga el enchufe cuando desconecte el cordón de energía.
- Hanteer het netsnoer voorzichtig. Houd het snoer bij de stekker vast wanneer deze moet worden aan- of losgekoppeld.
- Hantera nätkablen varsamt. Håll i kablarna när den kopplas från el-uttaget.
- Manuseie com cuidado o fio condutor de energia. Segure a tomada ao desconectar o fio.

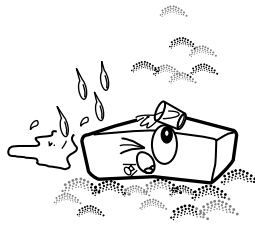

- Keep the set free from moisture, water, and dust.
- Halten Sie das Gerät von Feuchtigkeit, Wasser und Staub fern.
- Protéger l'appareil contre l'humidité, l'eau et la poussière.
- Tenete l'unità lontana dall'umidità, dall'acqua e dalla polvere.
- Mantenga el equipo libre de humedad, agua y polvo.
- Laat geen vochtigheid, water of stof in het apparaat binnendringen.
- Utsätt inte apparaten för fukt, vatten och damm.
- Mantenha o aparelho livre de qualquer umidade, água ou poeira.

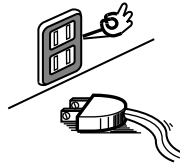

- Unplug the power cord when not using the set for long periods of time.
- Wenn das Gerät eine längere Zeit nicht verwendet werden soll, trennen Sie das Netzkabel vom Netzstecker.
- Débrancher le cordon d'alimentation lorsque l'appareil n'est pas utilisé pendant de longues périodes.
- Disinnestate il filo di alimentazione quando avete l'intenzione di non usare il filo di alimentazione per un lungo periodo di tempo.
- Desconecte el cordón de energía cuando no utilice el equipo por mucho tiempo.
- Neem altijd het netsnoer uit het stopcontact wanneer het apparaat gedurende een lange periode niet wordt gebruikt.
- Koppla ur nätkablarna om apparaten inte kommer att användas i lång tid.
- Desligue o fio condutor de força quando o aparelho não tiver que ser usado por um longo período.

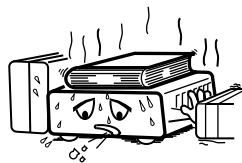

* (For sets with ventilation holes)

- Do not obstruct the ventilation holes.
- Die Belüftungsöffnungen dürfen nicht verdeckt werden.
- Ne pas obstruer les trous d'aération.
- Non coprite i fori di ventilazione.
- No obstruya los orificios de ventilación.
- De ventilatieopeningen mogen niet worden beblokkeerd.
- Tapp inte till ventilationsöppningarna.
- Não obstrua os orifícios de ventilação.

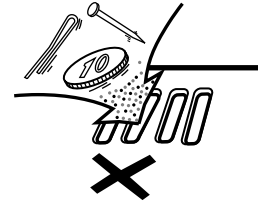

- Do not let foreign objects in the set.
- Keine fremden Gegenstände in das Gerät kommen lassen.
- Ne pas laisser des objets étrangers dans l'appareil.
- E' importante che nessun oggetto è inserito all'interno dell'unità.
- No deje objetos extraños dentro del equipo.
- Laat geen vreemde voorwerpen in dit apparaat vallen.
- Se till att främmande föremål inte tränger in i apparaten.
- Não deixe objetos estranhos no aparelho.

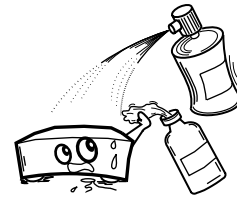

- Do not let insecticides, benzene, and thinner come in contact with the set.
- Lassen Sie das Gerät nicht mit Insektiziden, Benzin oder Verdünnungsmitteln in Berührung kommen.
- Ne pas mettre en contact des insecticides, du benzène et un diluant avec l'appareil.
- Assicuratevi che l'unità non venga in contatto con insetticidi, benzolo o solventi.
- No permita el contacto de insecticidas, gasolina y diluyentes con el equipo.
- Laat geen insectenverdelgende middelen, benzine of ververdunner met dit apparaat in contact komen.
- Se till att inte insektsmedel på spraybruk, bensen och thinner kommer i kontakt med apparatens hölje.
- Não permita que inseticidas, benzina e dissolvente entrem em contacto com o aparelho.

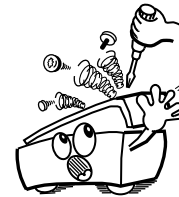

- Never disassemble or modify the set in any way.
- Versuchen Sie niemals das Gerät auseinander zu nehmen oder auf jegliche Art zu verändern.
- Ne jamais démonter ou modifier l'appareil d'une manière ou d'une autre.
- Non smontate mai, nè modificate l'unità in nessun modo.
- Nunca desarme o modifique el equipo de ninguna manera.
- Nooit dit apparaat demonteren of op andere wijze modificeren.
- Ta inte isär apparaten och försök inte bygga om den.
- Nunca desmonte ou modifique o aparelho de alguma forma.

**FRONT PANEL / FRONTPLATTE /
PANNEAU AVANT / PANEL FRONTAL /
FRAMSIDA**

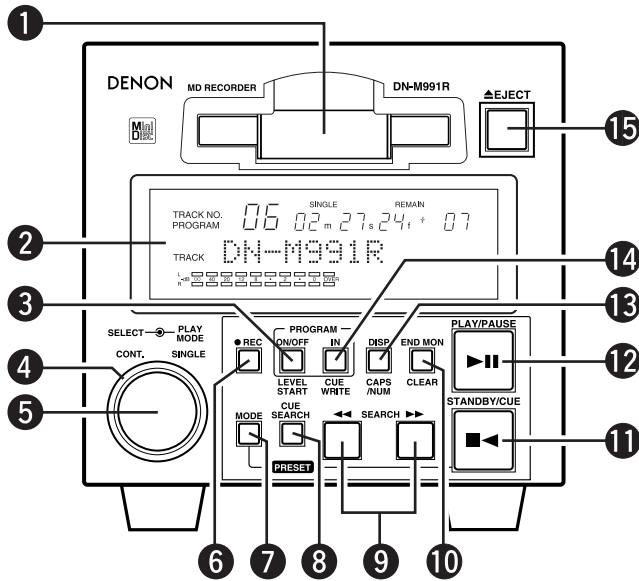

**REAR PANEL / RÜCKWAND /
PANNEAU ARRIERE / PANEL TRASERO /
BAKSIDA**

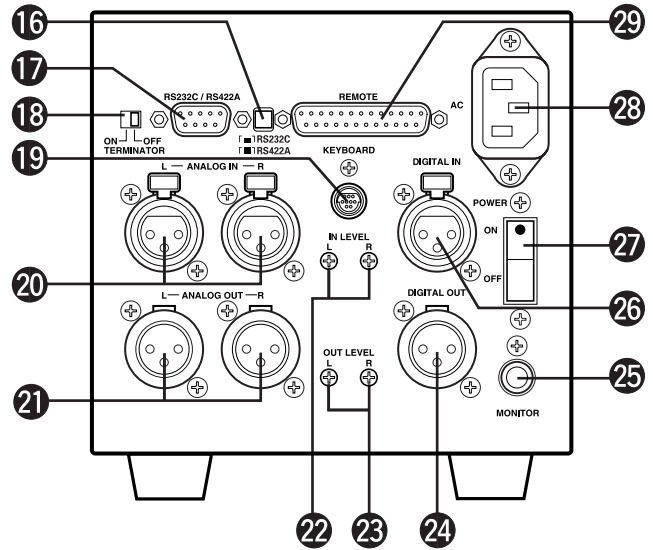

**DISPLAY WINDOW / DISPLAY-FENSTER / FENETRE D'AFFICHAGE /
PANTALLA DE VISUALIZACION / DISPLAYFÖNSTER**

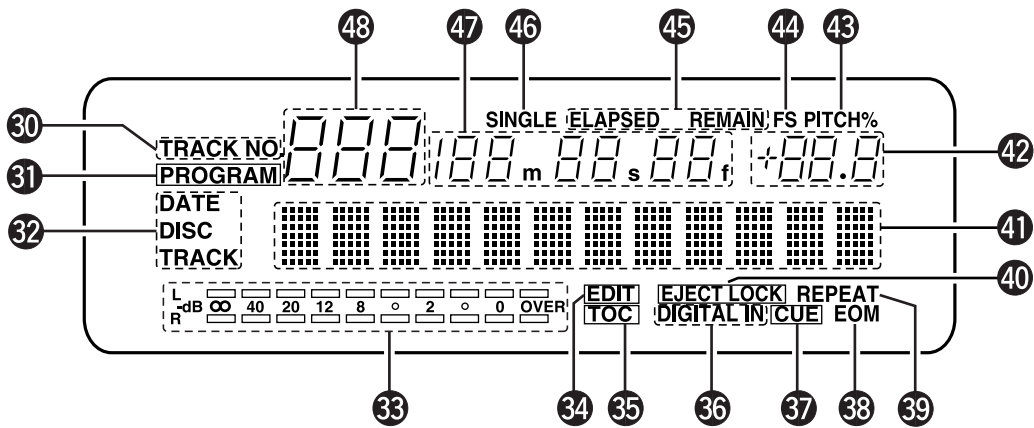

DIMENSIONS / ABMESSUNGEN / DIMENSIONS / DIMENSIONES / MÅTT

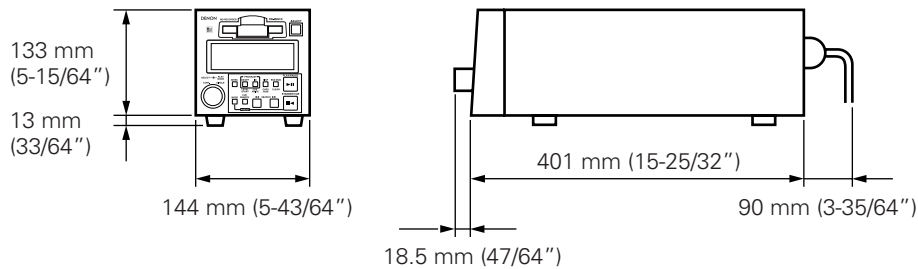

MAIN FEATURES

The DN-M991R MD recorder is a table-top type MD recorder designed for use in broadcast stations, for productions, etc.

Recording Functions

- **Auto Level Rec start**

This function automatically starts the recording operation when an audio signal level from an external unit connected to the DN-M991R exceeds the preset level (–36 to –66 dB, 6 steps) * You can turn off this function.

- **Auto Track Increment**

DN-M991R detects the silent portion of the program material and automatically increases the track number. The level of the silent portion can be set within a range of –36 to –66 dB (6 steps).

- **Stereo/Mono recording (74/148 min.)**

Playback Functions

- **Using CUE Signals to make searches (Up to 5 points per track)**

- **Track Search Select knob (Easy track selection)**

- **Program Play (Max. 25 tracks)**

Program can be stored in the preset memory.

- **Play mode and Finish mode**

1) Play mode ① Continuous: Play a whole disc ② Single: Play a track

2) Finish mode (Stop, Next, Recue, Repeat)

① Stop: Stop after finishing to play a track.

② Next: Standby at the beginning of next track after finishing to play a track.

③ Recue: After finishing to play a track, standby at the beginning of the track.

④ Repeat: The tracks are repeated according to the play mode.

- **Auto Cue**

After a track is selected it is automatically cued to the point where audio starts.

Cueing tracks place at the point where audio starts rather than where the track starts. The level at which sound is first detected can be set between –36 to –72 dB (7 steps).

- **End Monitor**

Pressing the END MON button during standby instantly previews the end of the track, thus assuring perfect “outros”. The point at which monitoring starts can be set within a range of 5 to 35 seconds (7 steps) prior to the track’s end.

- **End Of Message (EOM)**

At the end of a track, the EOM flashes, providing a visual warning to the operator that the track will end shortly. The point at which the flashing begins can be set within a range of 5 to 35 seconds (7 steps) prior to the end of the track.

- **Pitch Control (Preset) (+8.0 to –8.0 %, 0.1 step)**

- **Instant Start (Playback starts less than 0.01 seconds after the PLAY button is pressed.)**

Editing Functions

- **Editing**

1) Basic Editing

• DIVIDE: Smallest edited unit is 11.6 msec (1 sound group) • ERASE TRACK/ERASE DISC/ERASE CUE

• COMBINE • MOVE • DISC’s Pitch • TRACK NAME • DISC NAME

Up to 100 characters can be used for each name, however, the combined total number of characters cannot exceed 1700.

2) Cue signals also can be edited. (Can be erased, rewritten, or added to later.)

- **Undo function**

Undo function during editing (Up to 2 editing operations prior to the most recent one can be undone.)

- **SCMS**

Recording is possible without reception of the copy defeat restriction. Writing of the copy defeat code is selectable.

Functions for Systematization

- **Rich Array of External Control Terminals**

Serial Remote. (RS232C/RS422A switchcable, D-sub 9 pin)

Parallel Remote. (D-sub 25 pin)

- **Easy operations from IBM-PC™ compatible keyboard**

• PS/2 keyboard connector is equipped on the rear panel.

• Keyboard (PS/2 connector, US keyboard with 101 or 104 keys recommended) can be connected to perform playback, recording, program input, editing, hot start and other operations.

- **Hot Start function (Parallel remote, serial remote, keyboard)**

• Hot start is possible for up to 10 tracks.

• Tracks can be loaded into Hot Start by detecting the Auto Cue Level (–72/–66/–60/–54/–48/–42/–36 dB selectable in Preset mode).

• Sound can be loaded into Hot Start from any track location.

• Loaded tracks can be replaced with new tracks.

• Seamless Loop can be used during Hot Start playback.

• Hot Start operation is possible using parallel remote, serial remote or a keyboard (PS/2 connector, US keyboard with 101 or 104 keys recommended).

Other Functions

- **Large FL Display, Illuminated Button**

- **Sampling Rate Convertor**

• Digital input is possible at 32 and 48 kHz as well as 44.1 kHz.

• If input occurs at 32 or 48 kHz, it is automatically converted to 44.1 kHz during recording.

CONTENTS

| | | | |
|----------|--|-----------|---|
| 1 | PART NAMES AND FUNCTIONS8 ~ 11 | 8 | EDITING FUNCTIONS.....29 ~ 35 |
| | (1) Front Panel8, 9 | | (1) Editing Functions29 |
| | (2) Rear Panel9, 10 | | (2) Editing Function Select30 |
| | (3) Display Window10, 11 | | (3) Erasing Cue Signals «Cue erase function»30 |
| 2 | REMOTE CONTROL CONNECTIONS11, 12 | | (4) Erasing Tracks «Track erase function»31 |
| 3 | ABOUT MINIDISCS12 | | (5) Erasing All the Tracks on the Disc «All erase function»31 |
| 4 | PRESET FUNCTIONS AND OPERATIONS13 ~ 17 | | (6) Dividing Tracks into Two Parts «Divide function».....32 |
| | (1) List of Preset Functions13 | | (7) Combining Two Tracks «Combine function»32 |
| | (2) Presetting Procedure14 | | (8) Moving Tracks «Move function»33 |
| | (3) Detailed Description of Preset Functions15 ~ 17 | | (9) Pitch on the disc (Disc's pitch function)33 |
| 5 | BASIC OPERATION18 ~ 22 | | (10) Inputting (Changing) Names «Title function»34 |
| | (1) Starting Playback18 | | (11) Exit the Edit Mode or Undoing Editing «Undo functions» ...35 |
| | (2) End Monitor18 | 9 | CONNECTING AND OPERATING A KEYBOARD36, 37 |
| | (3) PLAY/PAUSE and STANDBY/CUE Operations19 | | (1) Connecting the Keyboard36 |
| | (4) Before Starting to Record19 | | (2) Keyboard Operations36, 37 |
| | (5) Method of Recording on Discs19 | 10 | RESETTING THE MICROPROCESSOR38 |
| | (6) Starting to Record20 | 11 | HANDLING CARTRIDGES38 |
| | (7) Stopping Recording20 | | (1) Cautions on Handling38 |
| | (8) Starting Recording Automatically by Detecting the Input Level21 | | (2) Cautions on Storing38 |
| | (9) Incrementing Track Numbers.....22 | 12 | MESSAGES39 |
| | (10) Pre-UTOC Function22 | 13 | SYSTEM LIMITATIONS40 |
| 6 | HANDY OPERATIONS23 ~ 25 | | (1) Track Number Limits40 |
| | (1) Setting Cue Points23 | | (2) Recording Time Limits40 |
| | (2) Direct Search for Cue Points24 | | (3) Editing Function Limits40 |
| | (3) Instantaneous play (Hot Start)25 | | (4) Title Function Limits40 |
| 7 | PROGRAMMED PLAYBACK26 ~ 28 | | (5) Other Limits40 |
| | (1) Inputting Programs26 | 14 | SPECIFICATIONS41 |
| | (2) Changing Programs26, 27 | | |
| | (3) Playing Programs27 | | |
| | (4) Presetting Programs28 | | |

Checking the Contents

Check that the carton contains the following items:

- 3P power supply cord1 pc.
- Operating instructions (this booklet)1 pc.

Installing the Units

Up to three units can be installed in a 19" EIA rack or console. Install shelves on the rack.

NOTES:

- To be ensure proper operation of the DN-M991R unit, set it so that the slant of its front panel is within 15° of the perpendicular.
- The display window (fluorescent tube) is designed so that all indications can be seen from within the angles shown below. Install the units so that the visual angle is within this range.

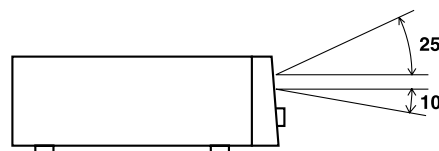
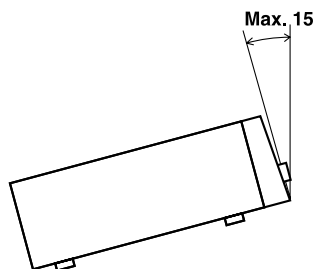

• DECLARATION OF CONFORMITY

We declare under our sole responsibility that this product, to which this declaration relates, is in conformity with the following standards:
 EN60065, EN55013, EN55020, EN61000-3-2 and EN61000-3-3.
 Following the provisions of 73/23/EEC, 89/336/EEC and 93/68/EEC Directive.

1 PART NAMES AND FUNCTIONS

(1) Front Panel

1 Cartridge insertion slot

- Insert the cartridge as indicated by the arrow on the top.
- Once the cartridge is partially inserted.

2 Display

3 PROGRAM ON/OFF/LEVEL START button PROGRAM ON/OFF (Normal mode)

- When this button is pressed while the PROGRAM IN button is lit, the program play mode is set.
- The button lights during the program play standby and play modes.
- When the button is pressed during the program play standby or play mode, the program play mode is cleared.

LEVEL START (REC mode)

- When this button is pressed during the recording pause mode, the auto level start recording mode is set.
- The button flashes when the auto level start recording mode is set.
- When the button is pressed again, the auto level start recording mode is canceled.

4 PLAY MODE switch

- When this switch is turned, the play mode select.

5 Select knob

- Turn this knob to select the next track to be played.
- Turn the knob clockwise by one click to move one track forward, counterclockwise by one click to move one track backward.
- When the knob turned while pressing it in, one click corresponds to 10 tracks.
- In the preset mode, use this knob to set and enter preset setting.
- When setting programs, use this knob to select, enter and check the program.
- In the cue point direct search mode, use this knob to select the cue point.
- The editing mode is set when the knob is turned and pressed while selecting the editing function.

6 REC button

- When this button is pressed during the stop, standby or pause mode, the recording pause mode is set.
- When the button is pressed during recording, the track number is incremented.
- The button lights when the recording or recording pause mode is set

7 MODE button

- Use this button to switch between the normal mode (recording and playback) and editing mode.
- When pressed the STANDBY/CUE button while pressing this button, the preset mode is set.

8 CUE SEARCH button

- When this button is pressed during the standby, pause, search or play mode, the cue signal point direct search mode is set. When pressed again, the direct search mode is canceled.
- The button lights when the direct search mode is set.

9 ◀◀ SEARCH and ▶▶ SEARCH buttons

- Use these buttons to change the play start position and for program operations.

10 END MON/CLEAR button END MON (Normal mode)

- Press this button in the standby mode to monitor the end of the track. (End Monitor)
- The button lights when the end monitor mode is set.

CLEAR (Edit mode)

- The button is used for editing operation and for clearing characters.

11 STANDBY/CUE button

- When this button is pressed during the play or pause mode, the pickup returns to the position at which playback started and the standby mode is set. **(Back Cue)**
- When pressed during playback when the next track has been programmed, the programmed track is searched for and the standby mode is set.
- The button lights when the standby mode is set.
- When the button is pressed during the recording or recording pause mode, recording stops, the pickup returns to the recording start position and the standby mode is set.
- When the button is pressed during the cue direct search mode, the cue point is searched.
- When the button is pressed while pressing the MODE button, the preset mode is set.

12 PLAY/PAUSE button

- Press this button in the standby, pause or manual search mode to begin playback.
- Press the button in the stop mode to search for the first track and begin playback.
- When the button is pressed in the recording pause mode, recording starts.
- The button lights when the play or recording mode is set.
- When the button is pressed during playback, the pause mode is set. The button flashes while the pause mode is set.
- When the button is pressed during recording, the recording pause mode is set. The button flashes when the recording pause mode is set.

13 DISP/CAPS/NUM button DISP (Normal mode)

- When the button is pressed for over 0.5 seconds, the character display switches between the disc name, track name and date, in that order.
- The date is only displayed when the date display is preset. (Refer to Page 13.)
- When the button is pressed for less than 0.5 second, the time display switches between the remaining time (REMAIN) and elapsed time (ELAPSED).

CAPS/NUM (REC, Edit mode)

- When the button is pressed while editing names, the selected characters switch between capital letters, small letters, numbers and symbols, in that order.

14 PROGRAM IN/CUE WRITE button PROGRAM IN (Normal mode)

- Press this button to set the program input mode.
- The button will not function during the play mode.
- The button flashes when in the program input mode.
- The button lights when a program is set.

CUE WRITE (REC, Edit mode)

- Press this button during the standby, pause, play, or manual search. When the edit mode and recording mode to record a cue signal.

15 EJECT button

- Press this button to eject the cartridge.
- The cartridge cannot be ejected during recording or while the UTOC is being written.

(2) Rear Panel

16 RS232C/RS422A selector switch

- Use this to switch the serial remote connector signal between RS232C and RS422A according to the external controller's signal.

17 RS232C/RS422A connector

- This is a serial remote connector. A personal computer or other external controller can be connected to control the DN-M991R externally.
- Applicable connector: 9-pin D-sub (female)
- Baud rate: 9600 bps or 19200 bps
- Pin layout:

| Pin No. | RS232C | | RS422A | |
|---------|-------------|-----|----------------|-----|
| | Signal name | I/O | Signal name | I/O |
| 1 | NC | - | NC | - |
| 6 | NC | - | S.GROUND | - |
| 2 | T x D | O | T x D (RETURN) | O |
| 7 | NC | - | T x D | O |
| 3 | R x D | I | R x D | I |
| 8 | NC | - | R x D (RETURN) | I |
| 4 | NC | - | NC | - |
| 9 | NC | - | NC | - |
| 5 | S.GROUND | - | NC | - |

18 TERMINATOR switch

- When set to the "ON" side, the serial remote connector's pins are terminated internally.

19 KEYBOARD connector

- To use a keyboard, connect it to this connector.
- The connector is a mini DIN type 6-pin connector.

20 ANALOG IN connectors

- These are active balanced inputs using XLR type connectors.
- Connect these connectors to the balanced analog output connectors on an amplifier or console.
- Pin layout:
 1. Common
 2. Hot
 3. Cold
- Applicable connector: Cannon XLR-3-32 or equivalent.

21 ANALOG OUT connectors

- These are active balanced outputs using XLR type connectors.
- Connect these connectors to the balanced analog input connectors on an amplifier or console.
- Pin layout:
 1. Common
 2. Hot
 3. Cold
- Applicable connector: Cannon XLR-3-31 or equivalent.

NOTE: Do not short-circuit the hot or cold pin with the common pin.

22 IN LEVEL L/R controls

- Use these controls to adjust the level of the audio signals from the ANALOG IN connectors.

23 OUT LEVEL L/R controls

- Use these controls to adjust the level of the audio signals from the ANALOG OUT connectors.

24 DIGITAL OUT (AES/EBU) connector

- This is an active balanced output using an XLR type connector.
- Connect this connector to the balanced digital input connector on an amplifier or console.
- Signal format: AES/EBU or SPDIF.
- Pin layout:
 1. Common
 2. Cold
 3. Hot
- Applicable connector: Cannon XLR-3-31 or equivalent.
- This unit uses a balanced digital output. A conversion circuit is necessary for connection to an unbalanced circuit.

Example of balanced/unbalanced conversion circuit.

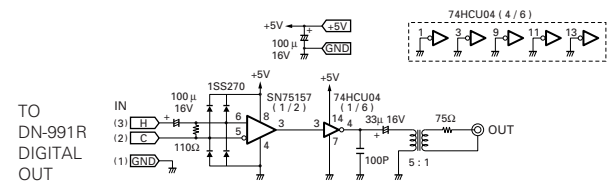

25 MONITOR jack

- Connect headphones with an impedance of 30 to 40 Ω/ohms.

26 DIGITAL IN (AES/EBU) connector

- This is an active balanced input using an XLR type connector.
- Connect this connector to the balanced digital output connector on an amplifier or console.
- Signal format: AES/EBU or IEC958 Type I
- Pin layout:
 1. Common
 2. Cold
 3. Hot
- Applicable connector: Cannon XLR-3-32 or equivalent.
- This unit uses a balanced digital input. A conversion circuit is necessary for connection to an unbalanced circuit.

Example of unbalanced/balanced conversion circuit.

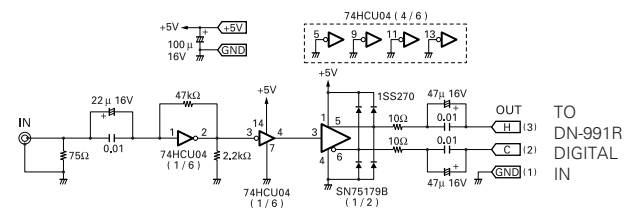

WARNING:

Turn PITCH control OFF when making digital recording. Most digital recorders will not accept a variable pitched digital signal.

27 POWER switch

- This turns the set on and off.

28 AC inlet

- Connect the included power cord here.

29 REMOTE connector

- This is a parallel remote connector. Use it to control the DN-M991R with dry contact circuit connections.
- Applicable connector: 25-pin D-sub (male)
- Connector signal layout:

| Pin No. | Hot Start ON | | Hot Start OFF | | Level |
|---------|----------------------|-----|----------------------|-----|-----------------|
| | Signal name | I/O | Signal name | I/O | |
| 1 | FG | – | FG | – | |
| 14 | PLAY CODE 1 tally | O | PLAY tally | O | TTL (Iol=20 mA) |
| 2 | PLAY CODE 1 command | I | PLAY command | I | HCMOS (Ii=3 mA) |
| 15 | PLAY CODE 2 tally | O | PAUSE tally | O | TTL (Iol=20 mA) |
| 3 | PLAY CODE 2 command | I | PAUSE command | I | HCMOS (Ii=3 mA) |
| 16 | PLAY CODE 3 tally | O | STDBY/CUE tally | O | TTL (Iol=20 mA) |
| 4 | PLAY CODE 3 command | I | STDBY/CUE command | I | HCMOS (Ii=3 mA) |
| 17 | PLAY CODE 4 tally | O | END CUE tally | O | TTL (Iol=20 mA) |
| 5 | PLAY CODE 4 command | I | TRACK (+) command | I | HCMOS (Ii=3 mA) |
| 18 | Tally common | O | Tally common | – | |
| 6 | PLAY CODE 5 command | I | TRACK (–) command | I | HCMOS (Ii=3 mA) |
| 19 | REPEAT command | I | REC command | I | HCMOS (Ii=3 mA) |
| 7 | STOP command | I | SEARCH (FWD) command | I | HCMOS (Ii=3 mA) |
| 20 | REPEAT tally | O | CUE tally | O | TTL (Iol=20 mA) |
| 8 | LOAD command | I | SEARCH (REV) command | I | HCMOS (Ii=3 mA) |
| 21 | LOAD tally | O | REC tally | O | TTL (Iol=20 mA) |
| 9 | FADER START command | – | FADER START command | I | PHOTO COUPLER |
| 22 | Tally power supply | O | Tally power supply | – | +5 V, 20 mA |
| 10 | FADER START return & | – | Command common | – | (Ii=10 mA) |
| 23 | Command common | – | Command common | – | |
| 11 | Reserved | – | REC E.O.M. | – | |
| 24 | Reserved | – | E.O.M. tally | O | DRY CONTACT |
| 12 | Reserved | – | Reserved | – | |
| 25 | Reserved | – | E.O.M. tally | O | DRY CONTACT |
| 13 | Hot Start ON (Low) | – | Hot Start OFF (High) | I | HCMOS (Ii=3 mA) |

NOTES:

- The tally output pin has open collector IC specifications (Imax. 20 mA, Vmax. 5 V), but the maximum supply current is 80 mA, so use with a total load current of 80 mA or less.
- 13 Pin enable when Hot start (Preset 36) set up off mode.

(3) Display Window

30 TRACK NO. indicator

- This lights When the track number display shows the selected track number.

31 PROGRAM indicator

- This lights when the Program play mode is set.

32 DISC NAME/TRACK NAME/DATE indicators

- “DISC NAME” lights when the disc name is displayed on the character display, “TRACK NAME” lights when the track name is displayed, and “DATE” lights when the date is displayed.

33 Level display

- This displays the playback level during playback, the input level during recording.

34 EDIT indicator

- This lights when the edit mode is set.

35 TOC indicator

- This lights when it is necessary to rewrite the TOC (UTOC) due to editing, etc
- This flashes while the TOC (UTOC) is being written.

36 DIGITAL IN indicator

- This lights (or flashes) when the digital input signal is selected.
- The indicator flashes when the digital signal is unlocked and remains lit when the digital signal is locked.

37 CUE indicator

- This lights for approximately 3 seconds when the position at which a cue signal is set is played.
- The indicator flashes when the standby mode is set at a position at which a cue signal is set.

38 EOM indicator

- This lights when the EOM is preset, and starts flashing when the EOM set time is reached.

39 REPEAT indicator

- When this indicator is lit, playback is repeated.

40 EJECT LOCK indicator

- When this indicator is lit, the eject lock function is set and the cartridge is not ejected even when the eject button is pressed.

41 Character display

- This displays disc names, track names and the date.
- Various instructions are displayed here during presetting, programming, editing, etc.

42 NEXT No. display

- This displays the number of the next track to be played.
- The program number is displayed during program input and editing.
- During recording, this indicates the digital input signal’s sampling frequency.
- When the playback pitch is changed, the pitch value flashes for 3 seconds.

- 43 **PITCH indicator**
 - This lights, When the set play speed is set.
- 44 **FS indicator**
 - This lights when the sampling frequency is displayed on the NEXT number display.
- 45 **TIME MODE indicators**
 - "ELAPSED" lights when the elapsed time is displayed.
 - "REMAIN" lights when the remaining time is displayed.

- 46 **PLAY MODE indicators**
 - "SINGLE" lights when in the single track play mode.
- 47 **Playing time display**
 - This indicates the time of the current position, in minutes (m), seconds (s) and frames (f).
- 48 **TRACK NO. display**
 - This displays the number of the track at the current position. This also lights during the track search mode and when switching to the standby mode.

2 REMOTE CONTROL CONNECTIONS

1. PARALLEL REMOTE

(1) HOT START OFF (Preset 36)

To control the DN-M991R remotely, refer to the example of remote control connections given below.

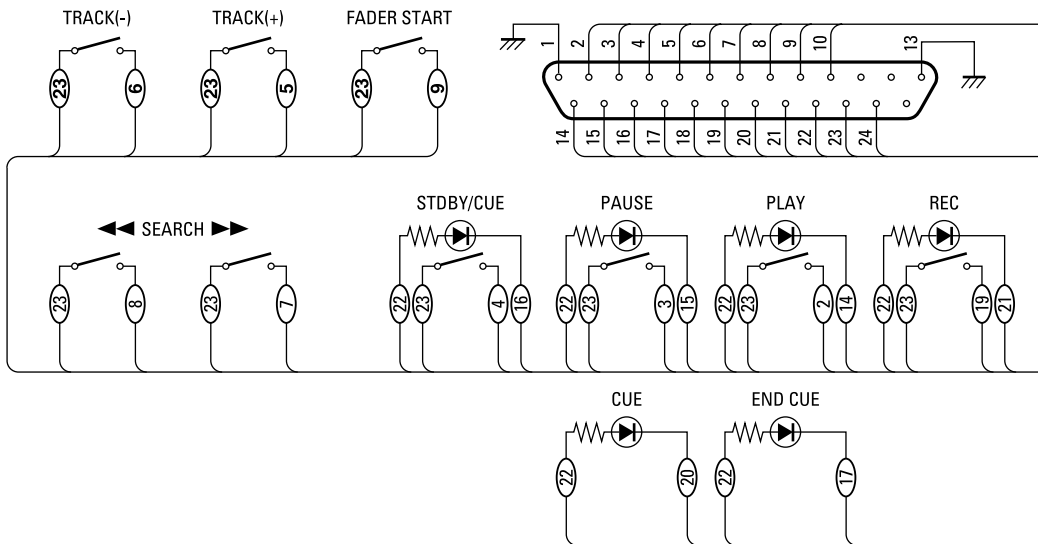

The rating of REMOTE connector pin 22 (TALLY POWER SUPPLY) is +5 V, 80 mA maximum. Avoid currents in excess of the rating.

(2) HOT START ON (Preset 36)

Parallel hot key output command table
HOT START playback of the number selected according to the settings on the table below starts.

| SW. No. | PLAY CODE 5 | PLAY CODE 4 | PLAY CODE 3 | PLAY CODE 2 | PLAY CODE 1 |
|---------|-------------|-------------|-------------|-------------|-------------|
| OFF | X | H | H | H | H |
| 9 | X | H | H | H | L |
| 8 | X | H | H | L | H |
| 7 | X | H | H | L | L |
| 6 | X | H | L | H | H |
| 5 | X | H | L | H | L |
| 4 | X | H | L | L | H |
| 3 | X | H | L | L | L |
| 2 | X | L | H | H | H |
| 1 | X | L | H | H | L |
| OFF | H | X | X | X | X |
| 10 | L | H | H | H | H |

Parallel hot tally output data table
The currently playing HOT START number is output according to the table below.

| SW. No. | PLAY TALLY 5 | PLAY TALLY 4 | PLAY TALLY 3 | PLAY TALLY 2 | PLAY TALLY 1 |
|---------|--------------|--------------|--------------|--------------|--------------|
| 1 | L | L | L | L | H |
| 2 | L | L | L | H | L |
| 3 | L | L | L | H | H |
| 4 | L | L | H | L | L |
| 5 | L | L | H | L | H |
| 6 | L | L | H | H | L |
| 7 | L | L | H | H | H |
| 8 | L | H | L | L | L |
| 9 | L | H | L | L | H |
| 10 | L | H | L | H | L |

(3) Relay Rec

Multiple DN-M991R's can be connected for relay playback.

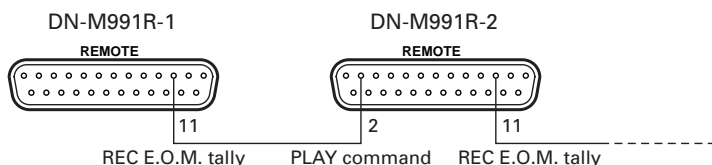

The "Relay Red Mode" is set when anything but "OFF" is selected for "Preset RelayRec" 19).

When a disc is loaded, the REC monitor mode is set automatically.

Once recording on the first DN-M991R (DN-M991R-1) starts and the disc's remaining recording time reaches the time specified with the presettings, an REC E.O.M. tally is output and recording starts on DN-M991R-2.

Thus, it is possible to record continuously on multiple DN-M991R's.

NOTE: The REC E.O.M. tally is output even if an error occurs on the recording component and the component stops.

2. SERIAL REMOTE

When using this unit connected to a controller or personal computer, connect the remote connector (RS-232C/RS-422A) to the controller using a 9-pin D-sub cable.

(1) When using the serial remote with a bus connection.

- 1 Set the preset "Player ID" to "0 to 15". (For the operation, see Page 13.)
- 2 Set the RS232C/RS422A selector switch of the rear panel to "RS-422A". (For the operation, see Page 9.)
- 3 Set the TERMINATOR switch.

Units connected midway through the bus connection:

Set the TERMINATOR switch to "OFF".

Units connected at the end of the bus connection:

Set the TERMINATOR switch to "ON".

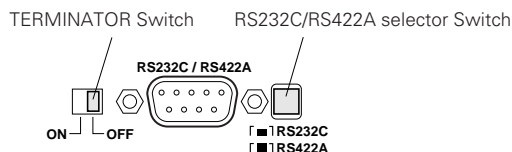

(2) When using the serial remote 1:1 with controller.

- 1 Set the preset "Player ID" to "OFF".
- 2 The RS232C/RS422A selector switch (a) of the rear panel can be used with either RS-422A or RS-232C.
- 3 Set the TERMINATOR switch to "ON".

3 ABOUT MINIDISCS

MiniDiscs allow a maximum of 74 minutes (stereo) of recording and playback in a compact size.

There are two types of MiniDiscs: those for playback only, and those for recording and playback.

Playback only MiniDiscs

- These discs are for playback only. Commercially available music MDs are of this type.
- These are laser discs, like regular compact discs.
- Tracks on such discs cannot be edited.

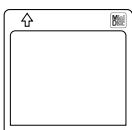

Recordable MiniDiscs

- These are magneto-optical discs on which both recording and playback are possible. Recording is performed through magnetic modulation.
- Re-recording is also possible.

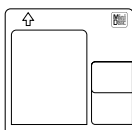

Accidental erasure prevention tabs

These tabs protect recordable MiniDiscs from accidental erasure.

To avoid accidentally erasing the recording, open the tab so that the hole is exposed. (See the diagram below.) When this is done, "Protected" is displayed if you attempt to record, erase or otherwise edit the disc, and the recording is protected. To record or erase the disc, set the tab back to its original position (with the hole covered).

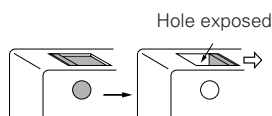

Recording on discs

MiniDiscs include a section in which the audio signals are recorded and a section in which such data as track numbers and track titles are recorded.

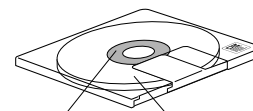

Section in which track numbers and track titles are recorded (TOC)

Section in which audio signals are recorded

The TOC

With MiniDiscs, after the audio signals are recorded, data used for checking the tracks (TOC—Table of Contents) is also recorded on the disc. This TOC data is used when playing the disc. In addition, editing is performed by rewriting the TOC data.

When TOC writing starts, the "TOC" indicator flashes. Do not shake the main unit, press the main unit's power button or unplug the power cord while the TOC is being written. If the data is not recorded properly, it will not be possible to play the disc.

Handling MiniDiscs

MiniDiscs are housed in cartridges, so there is no need to worry about dirt and scratches. However, dirty or warped cartridges may cause malfunction. Be careful of the following to ensure long-lasting, high quality sound:

- Do not touch the disc surface directly.
- Do not open the shutter by hand.
- Do not place MiniDiscs in dusty, dirty or humid places.
- Do not place MiniDiscs in places exposed to direct sunlight or high temperatures.

Cleaning

Use a dry cloth to gently wipe dirt or dust off the cartridge. Do not apply excessive force.

4 PRESET FUNCTIONS AND OPERATIONS

(1) List of Preset Functions

- Functions can be preset using the buttons on the front panel. These presets are stored in a permanent memory, so they are not cleared even when the power is turned off.
- The functions shown on the table below can be preset. Set the functions according to the usage purpose to efficiently achieve even higher quality playback.
- One of the preset functions can be used to display information on this set (microprocessor version).

| Classification grouping | No. | Preset function type | Description | Character display (as set upon shipment from factory) |
|-------------------------|--------|------------------------|--|---|
| AREA | 1 | Preset area | Selection of preset area | Preset Area1 |
| PLAYBACK | 2 | Play Finish mode | Play finish mode selection | Finish Next |
| | 3 | Play sound | Selection of stereo or monaural playback | Stereo |
| | 4 | Auto cue | Auto cue on/off setting start up level setting | CueDet.OFF |
| | 5 | Digital out | Selection of digital out format | D.Out Pro |
| | 6 | End monitor | Setting of whether or not to use the end monitor function and monitor time setting | End Mon.10s |
| | 7 | E. O. M. | Setting of whether or not to display the EOM and display time setting | E. O. M. 10s |
| | 8 | Delay start | Setting of delay playback start time | Delay OFF |
| | 9 | Playback speed | Selection of playback speed (-8.0 % ~ +8.0 % 0.1% step) | Pitch OFF |
| | 10 | Play pitch auto | Selection of whether or not to use pitch set for disc | PitchAutoOFF |
| | RECORD | 11 | Record input | Selection of recording input (analog or digital) |
| 12 | | Stereo/Mono | Stereo recording or mono recording selection | Rec Stereo |
| 13 | | Auto increment level | Auto increment level setting | IncDet.-60dB |
| 14 | | Auto increment | Auto increment selection | AutoInc OFF |
| 15 | | Pre UTOC | Pre-UTOC on/off setting | Pre UTOC OFF |
| 16 | | Recording start level | Recording start level setting | RecLv -60dB |
| 17 | | Recording start offset | Recording start offset time setting | RecOffsetOFF |
| 18 | | Copy management (SCMS) | Serial copy management on/off selection | SCMS INH |
| 19 | | Relay recording | Set the relay recording mode (on or off) and the timing for output of the REC E.O.M. tally when the relay recording mode is on | RelayRec OFF |
| PANEL KEY | 20 | Next track standby | Setting of whether or not to standby at the next track when the STANDBY/CUE button is pressed during playback | Next Stb.OFF |
| | 21 | Play lock | Selection of whether or not to inhibit the panel switches during playback | PlayLock OFF |
| | 22 | Eject lock | Selection of whether or not to lock ejecting during playback | EjectLockOFF |
| | 23 | Switch protect | Selection of whether or not to enable the panel switches | Switch ENA |
| DISPLAY | 24 | Date display | Date display on/off selection | DateDisp OFF |
| | 25 | Frame display | Selection of whether or not to display frame | FR Disp ON |
| PARALLEL REMOTE | 26 | Standby tally | Selection of whether to enable or inhibit the STDBY/CUE tally | St.Tally ON |
| | 27 | End cue | End cue time setting | EndCue -2s |
| | 28 | Tally selection | Setting of tally output signal with dry contact | DryCnt E.CUE |
| | 29 | Tally flash | Setting of tally output lit or flashing | T.Flash OFF |
| | 30 | Fader start | Fader start mode selection | Fader Pause |
| SERIAL REMOTE | 31 | Serial BPS | Baud rate setting | 9600bps |
| | 32 | Player ID | Player ID on/off selection and ID setting | PlayerID OFF |
| PROGRAM | 33 | Program 1 | Setting of whether or not to play program 1 | Program1 OFF |
| | 34 | Program 2 | Setting of whether or not to play program 2 | Program2 OFF |
| | 35 | Program 3 | Setting of whether or not to play program 3 | Program3 OFF |
| HOT START | 36 | Hot start | Hot start mode on/off selection for parallel remote | HotStart OFF |
| CLEAR | 37 | Preset clear | Setting for clearing presets and setting them to the initial values | Ini. Preset |
| VERSION | 38 | Set information | Microprocessor version display | S.xxxxD.yyyy (xxxx yyyy is a number.) |

(2) Presetting Procedure

- Functions can be preset using the buttons on the front panel.
- The presettings can also be set using serial remote signals (RS232C/RS422A).
- Presettings can be made when no cartridge is loaded or when in the stop, standby, pause, recording pause or recording monitor mode.

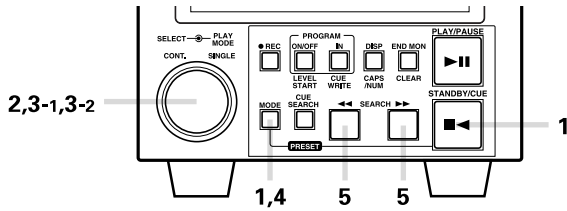

| 1 | <p>Enter the preset mode. Press the STANDBY/CUE button while pressing the MODE button.</p> <p style="text-align: center;">Character display Preset Mode</p> | | | | | | | | | | | | | | | |
|---------------|---|---------------|---|--------------|--------------|---|--------------|-------------|---|--------------|--------|---|------|-----------|---|-----------|
| 2 | <p>Select the preset item. Turn the select knob.</p> <p style="text-align: center;">Character display</p> <p>Turn the knob clockwise to move in the direction of the arrows, counterclockwise to move in the opposite direction.</p> <p>NOTE: The first preset item displayed is the last preset item displayed the last time the presettings were made.</p> | | | | | | | | | | | | | | | |
| 3-1 | <p>Change the preset values. Press the select knob.</p> <p>The character display changes as shown below.</p> <table style="width: 100%; border-collapse: collapse;"> <thead> <tr> <th style="text-align: left;">Before change</th> <th style="text-align: center;">⇒</th> <th style="text-align: left;">After change</th> </tr> </thead> <tbody> <tr> <td>Preset Area1</td> <td style="text-align: center;">⇒</td> <td>Preset Area2</td> </tr> <tr> <td>Finish Next</td> <td style="text-align: center;">⇒</td> <td>Finish Recue</td> </tr> <tr> <td>Stereo</td> <td style="text-align: center;">⇒</td> <td>Mono</td> </tr> <tr> <td>Pitch OFF</td> <td style="text-align: center;">⇒</td> <td>Pitch OFF</td> </tr> </tbody> </table> <p style="text-align: right;">Flashing</p> | Before change | ⇒ | After change | Preset Area1 | ⇒ | Preset Area2 | Finish Next | ⇒ | Finish Recue | Stereo | ⇒ | Mono | Pitch OFF | ⇒ | Pitch OFF |
| Before change | ⇒ | After change | | | | | | | | | | | | | | |
| Preset Area1 | ⇒ | Preset Area2 | | | | | | | | | | | | | | |
| Finish Next | ⇒ | Finish Recue | | | | | | | | | | | | | | |
| Stereo | ⇒ | Mono | | | | | | | | | | | | | | |
| Pitch OFF | ⇒ | Pitch OFF | | | | | | | | | | | | | | |

| | |
|------------|--|
| 3-2 | <p>Playback speed select. Turn the select knob to select the pitch.</p> <p style="text-align: right;">Flashing</p> <p>Press the select knob to set the pitch.</p> <p style="text-align: right;">Lit</p> |
| 4 | <p>Exit the preset mode. Press the MODE button.</p> <p>The preset mode is canceled and the set returns to the previous mode.</p> |
| 5 | <p>To set the presettings back to the initial settings (the settings set upon shipment from the factory). Turn the power on while holding in both the SEARCH ►► and the SEARCH ◀◀ buttons. For the initial settings, refer to "(1) List of preset functions".</p> <p>The character display changes as shown below.</p> <p style="text-align: center;">Initial Set</p> |

NOTE:
If the message shown below appears, there is a problem with the preset memory. Contact a serviceperson.

InitialError

NOTE:
The playback speed is the most recently set playback speed. For example, if the pitch is set with the presettings then set from the keyboard, the pitch set from the keyboard is used.

(3) Detailed Description of Preset Functions

(* = initial setting)

- 1) "Preset Area (*)" (Three different sets (areas) of presettings can be made and used for different purposes.)
 - * Preset Area1 : Set to preset Area 1.
 - Preset Area2 : Set to preset Area 2.
 - Preset Area3 : Set to preset Area 3.

- 2) "Finish (*)"
 - Finish Stop : Stop mode is set after track playing is finished.
 - * Finish Next : Standby mode is set at next track after track playing is finished.
 - Finish Recue : Standby mode is set at playback start position after track playing is finished.
 - Finish Repeat : The tracks are repeated according to the play mode.
* When "Finish Repeat" is selected, the repeat mode cannot be turned on and off from the parallel or serial ports or from the keyboard.

- 3) "Stereo (Mono)"
 - * Stereo : Output L and R stereo signals from the output connector.
 - Mono : Output mixed L and R signals from the output connector.

- 4) "CueDet. OFF (-**) dB"
 - * CueDet. OFF : Sound is not detected when cueing.
 - CueDet. (-**) dB : Sound detection level setting for cueing. (-72/-66/-60/-54/-48/-42/-36)

- 5) "D.Out Pro (Cons)"
 - * D.Out Pro : Output digital signals in AES/EBU format.
 - D.Out Cons : Output digital signals in SPDIF format.

NOTE: Auto Cue is not possible when the above is set to "D.Out Cons".

- 6) "End Mon. (**) sec"
 - End Mon. (**) sec : Set the end monitor time. (5/*10/15/20/25/30/35)
 - End Mon. OFF : Do not use the end monitor function.

- 7) "E.O.M. (**) sec" (Output EOM tally signal to remote pint (24))
 - E.O.M. (**) sec : Set the EOM time. (5/*10/15/20/25/30)
 - E.O.M. OFF : Do not use the EOM function.

- 8) "Delay (***) ms"
 - * Delay OFF : Do not use the delay start function.
 - Delay (***) ms : This sets the delay time from which the playback operation is started until playback starts. (100/200/300)

- 9) "Pitch (**.*) %"
 - * Pitch OFF : Playback at normal speed. (0.0 %)
 - Pitch (**.*) % : Playback at variable speed. (-8.0 ~ +8.0 %, 0.1 % step)

- 10) "PitchAuto OFF (ON)"
 - * PitchAuto OFF : Play pitch data stored on disc not used.
 - PitchAuto ON : Play disc at play pitch stored on disc.

- 11) "Analog (Digital) IN"
 - * Analog IN : Select the Analog input signal for recording.
 - Digital IN : Select the Digital input signal for recording.

- 12) "Rec Stereo (Mono)"
 - * Rec Stereo : Record in stereo.
 - Rec Mono : Record left channel signal in mono.

- 13) "IncDet. (-**) dB"
 - IncDet. (-**) dB : Sound detection level for auto increment function. (-66/*-60/-54/-48/-42/-36)

- 14) "AutoInc OFF (*)"
 - * AutoInc OFF : No auto increment of track number.
 - AutoInc Dig. : Track number is automatically incremented during digital recording using subcodes on CDs or MDs (Q codes) or start IDs on DATs.
 - AutoInc Det. : Track number is automatically incremented during recording when level set in "13) "IncDet. (-**) dB" setting is detected.

- 15) "Pre UTOC OFF (ON)" (Playback is possible up to that point even if power supply is cut off during recording or if recording stops due to some problem.)
 - * Pre UTOC OFF : Pre-UTOC function off.
 - Pre UTOC ON : Pre-UTOC function on.

- 16) "RecLv (-**) dB"
 RecLv (-**) dB : Sound detection level for auto record start function. (-66/*-60/-54/-48/-42/-36)
- 17) "RecOffset (*)" (Recording can be started before sound detection during auto record start operation.)
 RecOffset (*) : Recording starts the set number of seconds before level detection. (*OFF/1s/2s/3s/4s/5s)
- 18) "SCMS INH (ENA)"
 * SCMS INH : Record onto disc same code as copy prohibit code in recording source.
 SCMS ENA : Record copy prohibit code on disc according to SCMS.
- 19) "Rec EOM (***) s"
 * RelayRec OFF : Relay recording mode off.
 Rec EOM (***) s : Set the Relay recording mode to on and set time at which the REC E.O.M. tally is to be output (the number of seconds before the end of the recordable time). (30/60/90/120)
- 20) "Next Stb.OFF (ON)"
 * Next Stb.OFF : Return to the play start position and standby when the STANDBY/CUE button is pressed during playback.
 Next Stb.ON : Standby at the beginning of the next track when the STANDBY/CUE button is pressed during playback.
- 21) "PlayLock ON (OFF)"
 PlayLock ON : Inhibit all operations other than the PLAY/PAUSE, DISP buttons and PLAY MODE switch during playback.
 * PlayLock OFF : Enable all functions during playback.
- 22) "EjectLock ON (OFF)"
 EjectLock ON : The EJECT button is locked during playback.
 * EjectLock OFF : The EJECT button is not locked during playback.
- 23) "Switch ENA (INH)"
 * Switch ENA : Enable operation of all the switches on the front panel.
 Switch INH : Inhibit operation of all panel switches other than those used for presetting operations.
- 24) "DateDisp OFF (ON)"
 * DateDisp OFF : Date not displayed even when DISP button pressed.
 DateDisp ON : Date displayed when DISP button pressed.
- 25) "FR Disp ON (OFF)"
 * FR Disp ON : The frames are displayed on the time display during playback.
 FR Disp OFF : The frames are not displayed on the time display during playback. (They are displayed in the manual search, standby, pause and end monitor modes.)
- 26) "St.Tally ON (OFF)"
 * St.Tally ON : The stbby/cue tally signal is output from the REMOTE connector (pins 16).
 St.Tally OFF : The stbby/cue tally signal is not output from the REMOTE connector (pins 16).
- 27) "EndCue (-*) sec" (Cue signal can be emitted before playback is completed.)
 EndCue (-*) sec : End cue time setting. (0/-1/*-2/-3)
- 28) "DryCnt (EOM/E.CUE/CUE)"
 DryCnt EOM : The end of message tally signal is output from the REMOTE connector (pins 24).
 * DryCnt E.CUE : The end cue tally signal is output from the REMOTE connector (pins 24).
 DryCnt CUE : The cue tally signal is output from the REMOTE connector (pins 24).
- 29) "T.Flash ON (OFF)"
 * T.Flash ON : PLAY TALLY blinks during the EOM for parallel remote tally output, PAUSE TALLY blinks when pause, and STDBY TALLY blinks during the search operation. (The same display as on the front panel is output.)
 T.Flash OFF : The parallel remote tally output does not blink.
 The tally signal is output only when the PLAY/PAUSE and STDBY/CUE buttons' displays are lit.
- 30) "Fader Pause (Play)"
 * Fader Pause : Start playback when remote fader pins (9-10) are short-circuited and pause when pins are open.
 Fader Play : Start playback when remote fader pins (9-10) are short-circuited and continue playback when pins are open.
- 31) "9600 (19200) bps"
 * 9600 bps : Set the baud rate to 9600 bps.
 19200 bps : Set the baud rate to 19200 bps.
- 32) "PlayerID (**)"
 PlayerID (**) : Player ID setting.
 (Set ID to OFF or 0 to 15. Default setting – "OFF")

- 33) "Program1 OFF (ON)"
Program1 OFF (ON) : Store the contents of program 1 when on. (Initial setting – "OFF")
- 34) "Program2 OFF (ON)"
Program2 OFF (ON) : Store the contents of program 2 when on. (Initial setting – "OFF")
- 35) "Program3 OFF (ON)"
Program3 OFF (ON) : Store the contents of program 3 when on. (Initial setting – "OFF")
- 36) "HotStart OFF (ON)"
* HotStart OFF : The parallel remote is set up the Hot start off mode.
HotStart ON : The parallel remote is set up the Hot start on mode.
- 37) "Preset Clr? (Ini. Preset)"
Preset Clr? : Clear the presettings (set to the initial factory values).
* Ini. Preset : Presettings set to initial factory defaults.
- 38) "S.xxxxD.yyyy" : Display the microprocessor version. ("xxxx yyyy" is a number.)

5 BASIC OPERATION

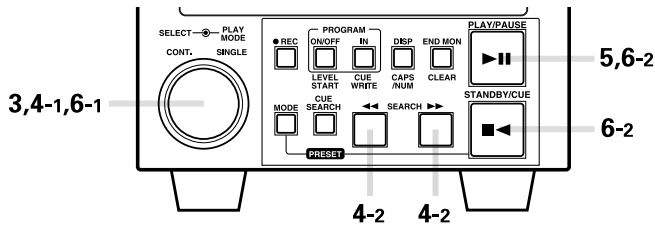

(1) Starting Playback

| | |
|------------|--|
| 1 | Load the cartridge. |
| 2 | Make the presettings according to the usage purpose. (See Page 13.) NOTE: Steps 1, 2 and 3 can be performed in the opposite order. |
| 3 | Select the play mode. Turn the PLAY MODE switch. Single track play mode SINGLE Continuous play mode SINGLE Lit |
| 4-1 | Select the track to be played. Turn the select knob. Flashing during search Lit when in standby The selected track is cued and the standby mode is set. |
| 4-2 | Starting playback from the middle of track. • To start from the middle of a track, use the SEARCH buttons to move to the desired position. • Press one of the SEARCH buttons (◀◀ or ▶▶) in the play, pause or standby mode to set the search mode. • Press the ▶▶ SEARCH button to move forward, the ◀◀ SEARCH button to move backward. To move forward To move backward |
| 5 | Start playback. Press the PLAY/PAUSE button. Lit (green) Off Playback begins and the playback signals are output. |

| | |
|------------|---|
| 6-1 | Presetting the next track to be played during playback. • The track at which the standby mode is to be set or the track to be played next after the current track is played can be preset by turning the SELECT knob during playback. In the single mode, the standby mode is set at the beginning of the next track. In the continuous mode, the next track is played when playback of the current track finishes. • The Next Track display of the set track number flashes. Example: When track 7 is selected while playing track 1 |
| 6-2 | Playback can be stopped in the following ways: Flashing Lit Playback is interrupted, the pickup returns to the play start position and the standby mode is set. (BACK CUE) Flashing (orange) Playback is interrupted and the pause mode is set at that point. |

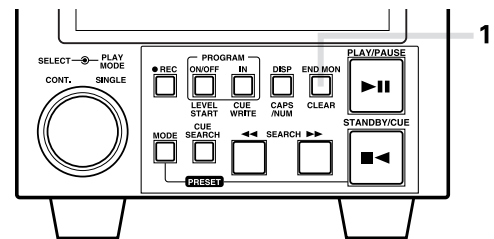

(2) End Monitor

| | |
|----------|--|
| 1 | To check the play end position. Press the END MON button when in the standby mode. Lit The track's end is monitored, then the pickup returns to the play start position and the standby mode is set. (End Monitor) NOTE: If the STANDBY/CUE button is pressed during the end monitor operation, the end monitor operation is canceled, the pickup returns to the play start position and the standby mode is set. |
|----------|--|

(3) PLAY/PAUSE and STANDBY/CUE Operations

- The operation switches between playback and pause each time the PLAY/PAUSE button is pressed.
- When the STANDBY/CUE button is pressed during playback, the pickup returns to the position at which playback was started.

The diagrams below show playback patterns when the PLAY/PAUSE and STANDBY/CUE buttons are pressed.

PLAY and PAUSE

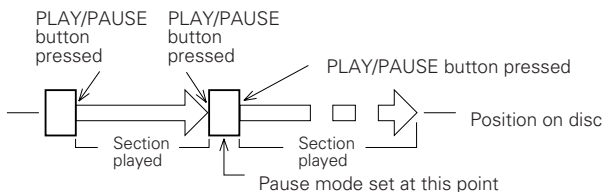

PLAY and CUE

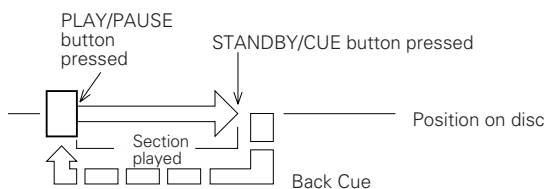

PLAY, PAUSE and CUE

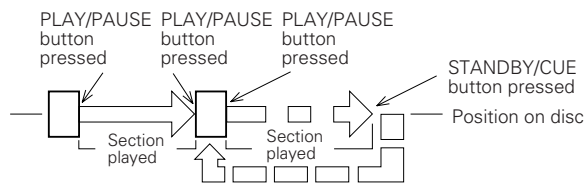

(4) Before Starting to Record

- Turn on the power. To record from the analog input, it is recommended to turn on the power at least 5 minutes before starting to record. This eliminates fluctuations of the A/D converter DC offset, reduces the amount of DC offset at the recording start position, in the middle of the recording and at the recording end position, and keeps the DC offset constant. DC offset hinders the auto cue function for detecting the point where the sound starts at low levels and the auto track increment function which detects soundless sections.
- Load a recordable disc. There are 60-minute and 74-minute recordable discs. For a description of recordable discs, see the section "Method of Recording on Discs" below. It is not possible to record on discs which are already recorded and have little free space left or on playback only discs.

(5) Method of Recording on Discs

| Disc for recording | | Method of recording on disc |
|--------------------|--|--|
| 1 | Discs on which nothing is recorded | Recording starts from the beginning of the disc. The beginning of the disc is found automatically, so there is no need to do this manually. |
| 2 | Recording on discs after erasing all their tracks | Same as above. |
| 3 | Recording on an already recorded disc | Recording starts from the end of the last recorded section. The end of the last recorded section is found automatically, so there is no need to do this manually. The set is designed so that it is not possible to record over a recorded section, so you cannot accidentally erase a previous recording. |
| 4 | Recording on discs after erasing part or all of the disc | If there is not enough remaining space or if you want to do the recording over, erase before recording. To erase one track at a time: Use the track erase function. To erase all the tracks at once: Use the all erase function. |

- Disc types
 - Blank discs:
 - Discs on which nothing is recorded
 - Discs you have just bought
 - Discs that have been erased (using the all erase function)
 - No-track discs:
 - Discs on which nothing is recorded but which contain a disc name
 - Blank discs which have been given a disc name
 - Discs with disc names on which all the tracks have been erased individually

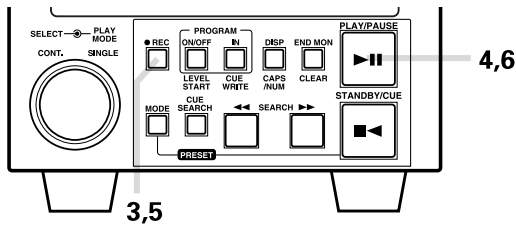

(6) Starting to Record

| | |
|----------|--|
| 1 | Load the cartridge. |
| 2 | <p>Set the presettings according to the purpose. (Refer to Page 13.)</p> <p>NOTE: Steps 1 and 2 can also be performed in the reverse order.</p> |
| 3 | <p>Set the recording pause mode. Press the REC button.</p> <p>Flashing (orange) Lit</p> <p>TRACK NO. 04 SINGLE ELAPSED 15m 42.06s Stereo Rec</p> <p>For a disc on which 3 tracks are already recorded.</p> <p>The disc's total number of tracks and playing time are displayed.</p> <p>NOTE: If the REC button is pressed in the stop mode, the recording monitor mode is set. (Only the REC button lights.)</p> |
| 4 | <p>Start recording. Press the PLAY/PAUSE button.</p> <p>Lit (green) Lit</p> <p>Recording starts and the TOC indicator lights.</p> <p>NOTE: If the DIGITAL IN indicator is flashing, the digital signal is unlocked. If this is the case, recording is not possible.</p> |
| 5 | <p>To change the track number during recording: Press the REC button.</p> <p>The track number is incremented and recording continues.</p> |

To pause recording:
Press the PLAY/PAUSE button.

Flashing (orange) Lit

Recording stops and the recording pause mode is set. To resume recording, press the PLAY/PAUSE button again. The track number is incremented and recording resumes.

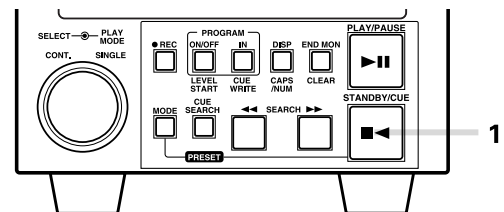

(7) Stopping Recording

Use one of the following methods to stop recording.

1

Lit once in standby

Recording stops, the UTOC is written and the standby mode is set.

The **TOC** indicator flashes while the UTOC is being written.

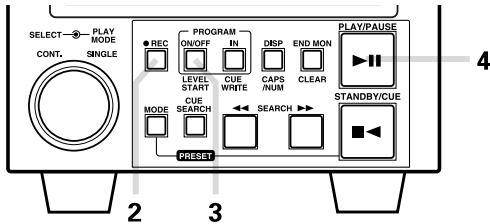

(8) Starting Recording Automatically by Detecting the Input Level

This function makes it possible to start recording by detecting the input signal level.

| | |
|----------|---|
| 1 | <p>Set the presettings. Make the following settings, referring to "Preset Functions and Operations" on Page 13.</p> <p>16) RecLv (-**) dB Recording starts when a signal with a level at or above the set level is input.</p> <p>17) RecOffset (*) Recording begins this number of seconds before the point where the set level is detected.</p> |
| 2 | <p>Set the recording pause mode. Press the REC button.</p> |
| 3 | <p>Set the recording level start mode. Press the LEVEL START button.</p> <p>NOTE: If the LEVEL START button is pressed while the button is flashing, the recording level start mode is canceled.</p> |
| 4 | <p>Start recording. Press the PLAY/PAUSE button.</p> <p>Recording starts when an input signal with a level at or above the set level is detected.</p> |

| | |
|-------------------------|---|
| 4 (continued) | <p>When the LEVEL START button is pressed in the input signal detection mode, recording starts immediately.</p> <p>During recording</p> |
| 5 | <p>To stop recording: Press the PLAY/PAUSE, STANDBY/CUE or STOP (Keyboard) button.</p> |

NOTE:
The auto track increment function and Auto Level Rec start function may not work when recording analog signals containing much noise. In this case lower the detection level to for example -54 dB.

(9) Incrementing Track Numbers

During recording, track numbers can be incremented either manually or automatically.

- Track numbers can be incremented manually in the following three ways:
 - 1) Press the REC button (●) during recording. This increments the track number.
 - 2) Press the PLAY/PAUSE button (▶||) during recording to stop recording for that track number and set the recording pause mode.
 - 3) After recording, use the divide function.

- Track numbers can be incremented automatically in the following three ways, according to the type of input signal:

| Input type | | Method |
|----------------------|-------------|------------------------------------|
| Analog/digital input | | Detection of soundless section 1) |
| Digital input | CDs and MDs | Detection of soundless section 1) |
| | | Using the CD's or MD's subcodes 2) |
| | DATs | Detection of soundless section 1) |
| | | Using the DAT's start IDs 3) |

- 1) Detection of soundless section
 - 1) Make the following two presettings:
 - Set "AutoInc OFF" 14) to "AutoInc Det."
 - Set the soundless detection level setting to "IncDet. (-60 dB" 13).
 - 2) Start playback and recording in such a way that the beginning of the sound is not missed. When a soundless section (or a section with level lower than the preset soundless detection level setting) of at least 2 continuous seconds is detected, the disc's track number is automatically incremented.

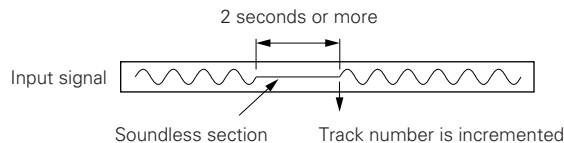

NOTE: The auto track increment function may not work when recording analog signals containing much noise. In this case lower the detection level to for example -54 dB.

- 2) Using the CD's or MD's subcodes (digital input)
 - 1) Make the following presetting:
 - Set "AutoInc OFF" 14) to "AutoInc Dig."
 - 2) Start playback on the CD (MD) player and recording on the recorder in such a way that the beginning of the sound is not missed. The disc's track number is automatically incremented when the CD's (MD's) track number changes. Changes in the CD's (MD's) track number will not be detected for approximately 4 seconds after the track number is incremented.

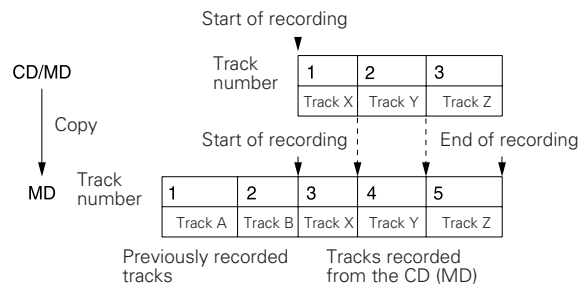

- 3) Using the DAT's start IDs (digital input)
 - 1) Record the start ID on the recorded DAT.
 - 2) Make the following presetting:
 - Set "AutoInc OFF" 14) to "AutoInc Dig."
 - 3) Start playback on the DAT player and recording on the recorder in such a way that the beginning of the sound is not missed. The disc's track number is automatically incremented when the DAT's start ID is detected. The start ID will not be detected for 15 seconds after the track number is incremented.

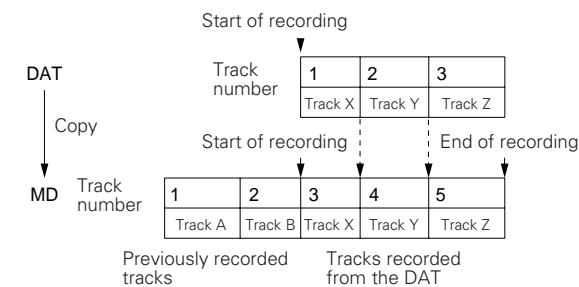

(10) Pre-UTOC Function

- Presettings must be set. (Refer to Page 15.)
- This function protects the recording should the power supply be cut off. The UTOC is written directly after recording starts.

(The pre-UTOC is written.)

Normally the UTOC is written after recording is completed, so if the power supply should be cut off during the recording or directly after the recording is finished, the recording will not be registered on the disc. To prevent this, the pre-UTOC (*1) is registered on the disc directly after recording starts. Once recording is completed normally, the actual UTOC (*2) is written. If the power should be cut before the actual UTOC is written, the disc can be played according to the pre-UTOC. This way you never accidentally lose recordings that cannot be made over again.

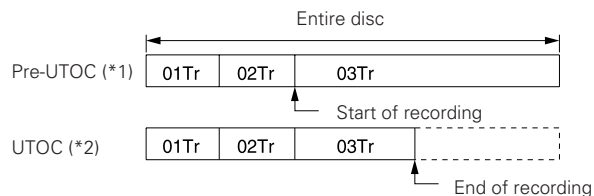

If some problem occurs and recording is interrupted, the same recording and UTOC can be written using the following editing operation:

Use the divide function at the point where recording was interrupted in track 03 on the above diagram to divide the track, then use the erase function to erase track 04.

NOTE:

The auto track increment function using the DAT's start ID or the CD's sub codes will not work if the digital input is in professional format (AES/EBU). Input digital signals of the consumer format (SPDIF).

6 HANDY OPERATIONS

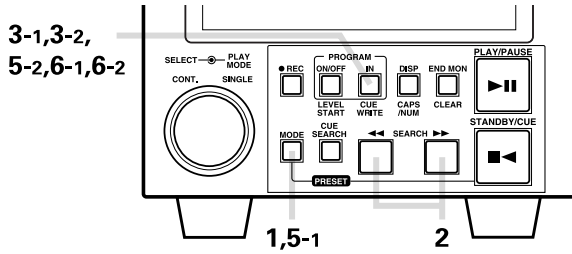

(1) Setting Cue Points

With this function, cue points can be set at any positions in tracks then searched for during playback. Up to five cue points can be set per track.

| | |
|------------|--|
| 1 | <p>In the standby, pause, manual search or play mode:</p> <p>Set the EDIT mode. Press the MODE button.</p> <p>MODE → EDIT (Lit)</p> |
| 2 | <p>Find the position at which you want to set the cue point. Use the SEARCH ►►/◄◄ buttons to find the position at which you want to set the cue point.</p> |
| 3-1 | <p>Set the cue point. Press the CUE WRITE button.</p> <p>MODE → CUE WRITE (Lit) CueWrite OK?</p> |
| 3-2 | <p>Press the CUE WRITE button again while Cue Write OK? is displayed.</p> <p>CUE WRITE (Lit) CueWrite OK? → Complete! (Flashing)</p> <p>IN CUE WRITE (Off) TOC (Lit) CUE (Flashing)</p> |
| 4 | <p>To continue setting other cue points: Repeat steps 2, 3-1 and 3-2.</p> |
| 5-1 | <p>Write the UTOC. (Cancel the edit mode.) Press the MODE button.</p> <p>MODE → UTOC Write? (Lit)</p> |

| | |
|------------|---|
| 5-2 | <p>Press the REC button while UTOC Write? is displayed.</p> <p>REC (Lit) UTOC Write? → UTOC Writing (Flashing)</p> <p>TOC (Lit) CUE (Off)</p> |
| 6-1 | <p>To set cue points during recording:</p> <p>Press the CUE WRITE button.</p> <p>IN CUE WRITE (Lit) CueWrite OK?</p> |
| 6-2 | <p>Press the CUE WRITE button again while Cue Write OK? is displayed.</p> <p>IN CUE WRITE (Lit) CueWrite OK? → Complete! (Flashing)</p> <p>IN CUE WRITE (Off) <CUE></p> <p>NOTE: The UTOC is written once recording is completed.</p> |

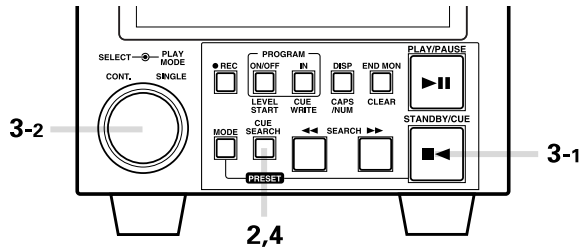

(2) Direct Search for Cue Points

When cue points are stored on a track, they can be used for direct search.

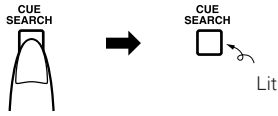
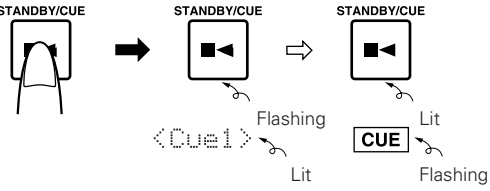
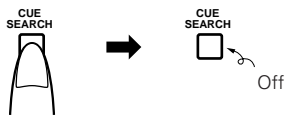
| | |
|------------|--|
| 1 | <p>Load the cartridge.</p> |
| 2 | <p>Set the cue direct search mode. Press the CUE SEARCH button.</p>  <p>NOTE: The cue direct search mode cannot be set if no cue points are stored on the disc.</p> |
| 3-1 | <p>Search for the cue point. Press the STANDBY/CUE button.</p>  <p>The Cue1 point is searched for and the standby mode is set at that position. Press the STANDBY/CUE button again to search as follows:</p> <p><Cue2> ⇄ <Cue3> □□□ ⇄ <Cue5> ⇄ <Cue1></p> |
| 3-2 | <p>Cue points can also be searched for by turning the select knob.</p> <p>When turned clockwise: <Cue1> ⇄ <Cue2> □□□ ⇄ <Cue5> ⇄ <Cue1></p> <p>When turned counterclockwise: <Cue5> ⇄ <Cue4> □□□ ⇄ <Cue1> ⇄ <Cue5></p> |
| 4 | <p>Cancel the cue direct search mode.</p>  <p>The set returns to the normal operating mode.</p> |

(3) Instantaneous play (Hot Start)

Preset up to 10 tracks using the parallel remote, the serial remote or a key board (PS/2 connector, US keyboard with 101 or 104 keys recommended) to enable instantaneous play of the desired tracks. This function is called instantaneous play (Hot Start).

- When parallel remote is to be used, a control circuit for instantaneous play (Hot Start) is required. For information about the control circuit, contact your store of purchase.
- When serial remote is to be used, contact your store of purchase.

NOTE:

The hot start data is cleared if the editing or recording operations are performed during the hot start mode.

NOTES:

- The instantaneous play (Hot Start) mode will end with one track.
- A press of a number button during the instantaneous play (Hot Start) mode will cause the unit to switch to the track of the pressed number and start playing.
- Cue detection is also performed at the time of instantaneous play (Hot Start) loading.



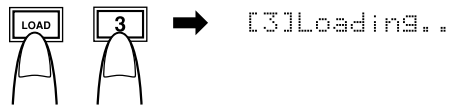

Tracks with a setting level less than 10 seconds from the beginning of the track are loaded from the beginning of the track.

Even when the level of cue detection is changed after loading, the pause position will not change until the initial data is cleared.

Hot Start Load

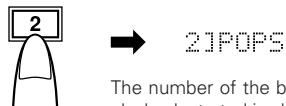
| | | | | | | | | | | | | | |
|--------------------------------|---|------|------|-------|------|------|------|--------------------------------|------|------|------|-------|--|
| 1 | <p>Data loading. Set the cartridge and cue or pause at the track for hot start playback.</p> | | | | | | | | | | | | |
| 2-1 | <p>10 TRACK LOAD. Press the the LOAD button.</p> <ul style="list-style-type: none"> • The data for ten tracks starting from the track at which the cue or pause mode is set is loaded into the hot start RAM.  <p>(Example: Track 4 is set to pause)</p> <table border="1" style="width: 100%; text-align: center;"> <tr> <td>Disc</td> <td>4Tr</td> <td>5Tr</td> <td>12Tr</td> <td>13Tr</td> <td>14Tr</td> </tr> <tr> <td>Instantaneous play (Hot Start)</td> <td>No.1</td> <td>No.2</td> <td>No.9</td> <td>No.10</td> <td></td> </tr> </table> <ul style="list-style-type: none"> • When the data loading is completed, the STANDBY/CUE button will light and the unit will be set to instantaneous play (Hot Start) standby. <p>NOTE: When the stop operation is set during data loading and the data loading number (from 1 to 10) is completed, data loading of subsequent tracks is stopped.</p> | Disc | 4Tr | 5Tr | 12Tr | 13Tr | 14Tr | Instantaneous play (Hot Start) | No.1 | No.2 | No.9 | No.10 | |
| Disc | 4Tr | 5Tr | 12Tr | 13Tr | 14Tr | | | | | | | | |
| Instantaneous play (Hot Start) | No.1 | No.2 | No.9 | No.10 | | | | | | | | | |
| 2-2 | <p>1 TRACK LOAD. While depressing the LOAD button, press the number button (from 1 to 10) for which data is to be entered.</p>  <ul style="list-style-type: none"> • When data loading is completed, the CUE LED lights steadily. | | | | | | | | | | | | |
| 2-3 | <p>PROGRAM TRACK LOAD.</p> <ul style="list-style-type: none"> • Hot start data can also be loaded in the programmed play mode. The data is loaded in the programmed order. The programmed play mode is canceled after the data is loaded. | | | | | | | | | | | | |

Hot Start

| | |
|----------|--|
| 1 | <p>Starting the play operation. During instantaneous play (Hot Start) standby, press the number button (from 1 to 10) that is to be played to start the instantaneous play (Hot Start) operation.</p>  <p>The number of the button for the track at which playback started is shown on the display.</p> <ul style="list-style-type: none"> • The PLAY/PAUSE button flashes when an EOM is detected during playback (when the EOM is turned on with the presetting). • When play finishes, the unit returns to instantaneous play (Hot Start) standby. |
| 2 | <p>Stopping the play operation. A press the STOP button during the play operation causes the play to stop and returns the unit to instantaneous play (Hot Start) standby.</p>  |
| 3 | <p>Repeat play. When the REPEAT button is pressed, the repeat mode is set. Press the number button of the track to be played (from 1 to 10) to repeatedly play that track.</p> <ul style="list-style-type: none"> • Press the REPEAT button while a track is being played to repeatedly play that track. • Press the REPEAT another time to cancel the repeat play mode.  |
| 4 | <p>Set the standby mode and press the MODE button on the main unit twice to cancel the hot start mode.</p> <ul style="list-style-type: none"> • The hot start mode is canceled and the edit mode is set.  |

7 PROGRAMMED PLAYBACK

- The tracks can be programmed to play in a certain order.
- Up to 25 tracks can be programmed.
- Programmed playback is performed according to the play mode (single or continuous) and preset finish mode (stop, next, recue or repeat) settings.

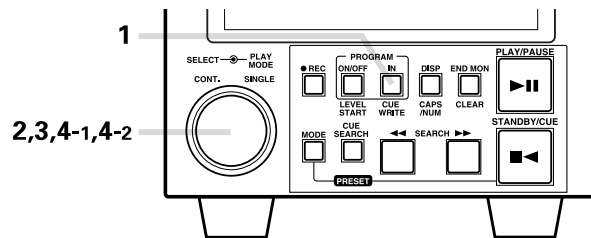
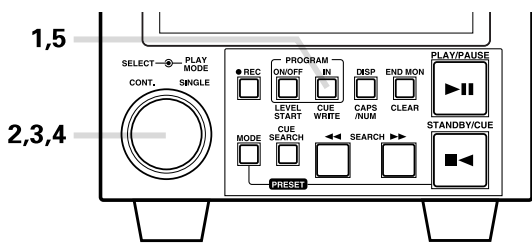

(1) Inputting Programs

| | |
|---|--|
| 1 | <p>Set the program input mode. Press the PROGRAM IN button.</p> <p>The step number lights</p> |
| 2 | <p>Select the track to be programmed. Turn the select knob.</p> <p>The step number flashes</p> |
| 3 | <p>Select the track to be programmed. Turn the select knob.</p> <p>When track 3 is selected:</p> <p>Selected track number</p> <p>Flashing</p> |
| 3 | <p>Enter the selected track in the program. Press the select knob.</p> <p>The number of the next step in the program is displayed.</p> |
| 4 | <p>Enter the next track in the program. Press the select knob.</p> <p>The time display shows the total playing time for the program.</p> <p>Repeat steps 2, 3 and 4 to program the tracks in the desired order.</p> |
| 5 | <p>Exit the program input mode. Press the PROGRAM IN button.</p> <p>The set returns to the normal mode.</p> |

(2) Changing Programs

| | |
|-----|---|
| 1 | <p>Set the program edit mode. Press the PROGRAM IN button.</p> <p>The step number lights</p> |
| 2 | <p>Select the step number to be edited. Turn the select knob.</p> <p>To edit the third step in the program:</p> <p>Lit</p> |
| 3 | <p>Set the program change mode. Press the select knob.</p> <p>The step number to be edited flashes</p> |
| 4-1 | <p>To change the track: Select the track to be changed. Turn the select knob.</p> <p>When track 7 is selected:</p> <p>Selected track number</p> <p>Flashing</p> |
| 4-2 | <p>Enter the selected track. Press the select knob.</p> <p>The number of the next step in the program lights</p> <p>To continue editing the program, repeat steps 2, 3, 4-1 and 4-2.</p> |

To exit the program editing mode, press the **PROGRAM IN** button. The set returns to the normal mode.

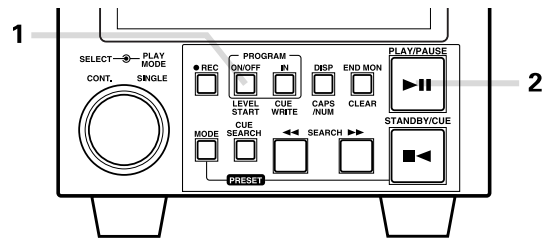
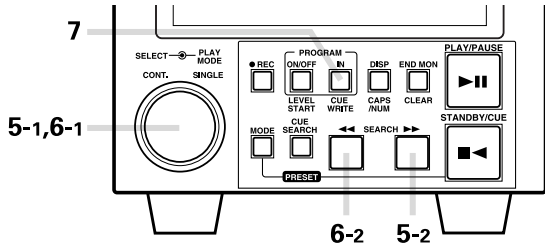

| | |
|-----|--|
| 5-1 | <p>Inserting a track in the program.</p> <p>Select the position at which to insert a track. Turn the select knob.</p> <p>To insert a track at the third step in the program:</p> <p>TRACK NO. 05 SINGLE 30m 28s 47, 03 TRACK Mirage Lit</p> |
| 5-2 | <p>Set the program insert mode. Press the SEARCH button.</p> <p>TRACK NO. 05 SINGLE 30m 28s 47, 03 TRACK Select Tr? The step number flashes</p> |
| 5-3 | <p>Perform the same operations as in steps 4-1 and 4-2 to select the track to be inserted.</p> <p>To insert more tracks in the program, repeat steps 5-1, 5-2, and 5-3. (To exit the program insert mode, press the PROGRAM IN button.)</p> |
| 6-1 | <p>Deleting tracks from the program</p> <p>Select the step to be deleted. Turn the select knob.</p> <p>To delete the track at the third step:</p> <p>TRACK NO. 05 SINGLE 30m 28s 47, 03 TRACK Mirage Lit</p> |
| 6-2 | <p>Delete that track from the program. Press the SEARCH button.</p> <p>Number of track at the next step in the program:</p> <p>TRACK NO. 08 SINGLE 27m 36s 15, 03 TRACK Touch The Ne The next step number lights</p> <p>To continue deleting tracks from the program, repeat steps 6-1 and 6-2.</p> |
| 7 | <p>Exit the program editing mode. Press the PROGRAM IN button.</p> <p>PROGRAM IN Lit</p> |

(3) Playing Programs

| | |
|---|---|
| 1 | <p>Set the program play mode. Press PROGRAM ON/OFF button.</p> <p>TRACK NO. 03 SINGLE 30m 28s 47, 02 TRACK Light Of Lov Lit</p> <p>The first track in the program is cued and the standby mode is set.</p> |
| 2 | <p>Start programmed playback. Press the PLAY/PAUSE button.</p> <p>PROGRAMMED playback starts.</p> |

- When the cartridge is ejected, the set program is cleared.
- If a track that is not in the program is selected with a serial command during programmed playback, that command is ignored.

NOTE:
Programs cannot be input when no disc is loaded.

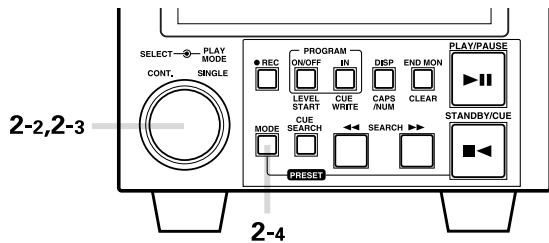

(4) Presetting Programs

- Programs can be stored in the preset memory. When a cartridge for which a program is preset is loaded, the programmed playback mode is set automatically.
- Programs can be stored for up to three cartridges.

| | | | | | | | | | | | | | |
|---------------|---|---------------|---|--------------|--------------|--|-------------|--------------|--|-------------|--------------|--|-------------|
| 1 | <p>Input the program. Following the instructions under "(1) Inputting Programs" to input the program. (See Page 26.)</p> | | | | | | | | | | | | |
| 2-1 | <p>Set the preset mode. Follow the instructions under "(2) Presetting Procedure" to set the preset mode. (See Page 14.)</p> | | | | | | | | | | | | |
| 2-2 | <p>Select the preset item. Turn the select knob to select "Program 1" (or "Program 2" or "Program 3").</p> <p>Select one of these.</p> | | | | | | | | | | | | |
| 2-3 | <p>Change the preset setting. Press the select knob.</p> <p>The character display changes as follows:</p> <table style="width: 100%; text-align: center;"> <tr> <td>Before change</td> <td>⇒</td> <td>After change</td> </tr> <tr> <td>Program1 OFF</td> <td></td> <td>Program1 ON</td> </tr> <tr> <td>Program2 OFF</td> <td></td> <td>Program2 ON</td> </tr> <tr> <td>Program3 OFF</td> <td></td> <td>Program3 ON</td> </tr> </table> | Before change | ⇒ | After change | Program1 OFF | | Program1 ON | Program2 OFF | | Program2 ON | Program3 OFF | | Program3 ON |
| Before change | ⇒ | After change | | | | | | | | | | | |
| Program1 OFF | | Program1 ON | | | | | | | | | | | |
| Program2 OFF | | Program2 ON | | | | | | | | | | | |
| Program3 OFF | | Program3 ON | | | | | | | | | | | |
| 2-4 | <p>Cancel the preset mode. Press the MODE button.</p> <p>The preset setting mode is canceled and the set returns to the normal mode.</p> | | | | | | | | | | | | |

8 EDITING FUNCTIONS

(1) Editing Functions

There are nine editing functions possible on MDs, as described below. Here we describe these functions briefly.

1 Cue erase function (erasing cue signals)

Cue signals (external control signals) recorded on the disc can be erased without affecting the tracks.

2 Track erase function (for erasing specific tracks)

An entire track, from beginning to end, can be erased instantaneously simply by operating buttons. Unlike tapes, there is no need to record over, erase, or cut the tape.

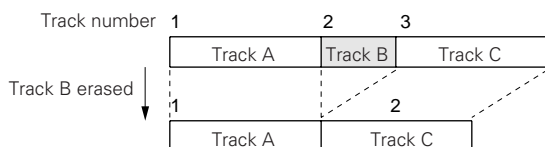

3 All erase function (for erasing all the tracks on the disc)

All the tracks on the disc can be erased instantaneously simply by operating buttons. Unlike tapes, there is no need to use an eraser or record over.

4 Divide function (for dividing a track in two)

One track can be divided into two tracks. This makes it possible to easily set search points simply by operating buttons after recording.

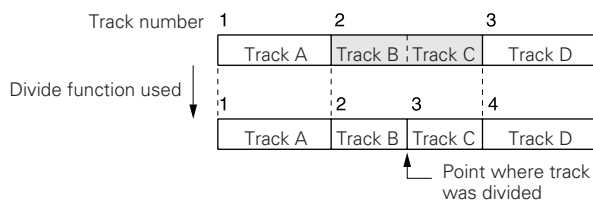

5 Combine function (for combining two tracks)

Short recordings or cuts created by dividing tracks can be combined into a single track. Unlike tapes, there is no need to copy over or cut the tape.

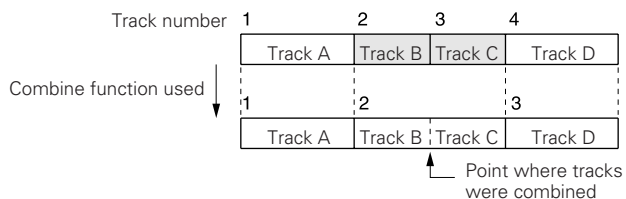

6 Move function (for moving tracks)

The order of the tracks can be changed. Unlike tapes, there is no need to copy over or cut the tape.

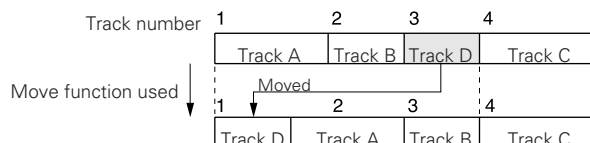

7 Pitch on the disc function (Disc's Pitch)

This function make it possible to set and store a certain play speed on the disc, then play the disc at that speed. When the presetting is set to "PitchAuto ON" and this disc is loaded, the disc is played at the written pitch.

8 Disc name/Track name function

Disc names or track names can be stored on recorded discs. The disc names and track names can be called out on the display using the display function.

9 Undo functions (for undoing the editing)

Even after editing is completed, the editing can be undone as long as the UTOC has not yet been written.

There are three types of undo functions:

- 1) UNDO: For undoing the last editing operation.
- 2) REDO: For resetting the editing undone with the undo function.
- 3) FIRST: For undoing all the editing operations.

When three editing operations have been performed:

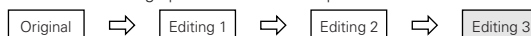

When the **undo** function is used: Only the first two editing operations remain.

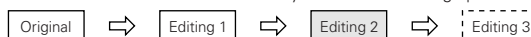

When the **undo** function is used again: Only the first editing operation remains.

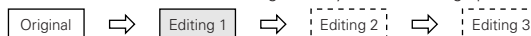

When the **redo** function is used: The first two editing operations remain.

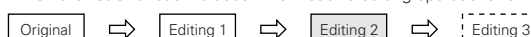

When the **first** function is used: None of the editing operations remain.



(Editing operations 1, 2 and 3 cannot be retrieved.)

NOTE:

During the edit mode, the eject lock function is set and the cartridge can not be ejected.

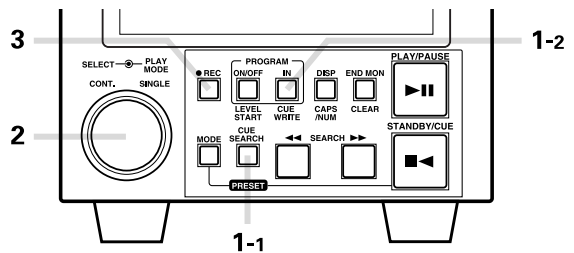
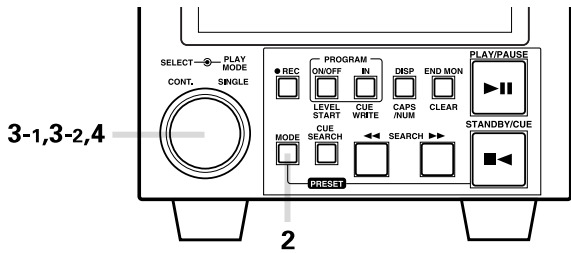

(2) Editing Function Select

(3) Erasing Cue Signals «Cue erase function»

| | | | | | | | | | | | |
|------------------------|--|----------------------|-----------------|------------------------|-------------------------|----------------------|----------------------|-------------------|-----------------------|--------------------|--|
| 1 | <p>Load the cartridge.</p> | | | | | | | | | | |
| 2 | <p>Set the edit mode. Press the MODE button.</p> | | | | | | | | | | |
| 3-1 | <p>Select the edit track. The track to be edited can be selected (or changed) by turning the SELECT knob.</p> | | | | | | | | | | |
| 3-2 | <p>Set the edit function select mode. Select the edit track and press the SELECT knob.</p> <p>NOTE: "Cue Erase?" is not displayed if no cue signal is set.</p> | | | | | | | | | | |
| 4 | <p>Select the edit function. Turn the select knob.</p> <p>NOTES:</p> <ul style="list-style-type: none"> • "Cue Erase?" is not displayed if no cue signals is set. • "Divide?", "Combine?" and "Move?" are not displayed in the stop mode. | | | | | | | | | | |
| 5 | <p>After selecting the edit function in item 3, perform the operations for the various edit items.</p> <table border="0"> <tr> <td>Cue Erase? ⇒ page 30</td> <td>Move? ⇒ page 33</td> </tr> <tr> <td>Track Erase? ⇒ page 31</td> <td>Pitch? **, *% ⇒ page 33</td> </tr> <tr> <td>All Erase? ⇒ page 31</td> <td>Disc Name? ⇒ page 34</td> </tr> <tr> <td>Divide? ⇒ page 32</td> <td>Track Name? ⇒ page 34</td> </tr> <tr> <td>Combine? ⇒ page 32</td> <td></td> </tr> </table> | Cue Erase? ⇒ page 30 | Move? ⇒ page 33 | Track Erase? ⇒ page 31 | Pitch? **, *% ⇒ page 33 | All Erase? ⇒ page 31 | Disc Name? ⇒ page 34 | Divide? ⇒ page 32 | Track Name? ⇒ page 34 | Combine? ⇒ page 32 | |
| Cue Erase? ⇒ page 30 | Move? ⇒ page 33 | | | | | | | | | | |
| Track Erase? ⇒ page 31 | Pitch? **, *% ⇒ page 33 | | | | | | | | | | |
| All Erase? ⇒ page 31 | Disc Name? ⇒ page 34 | | | | | | | | | | |
| Divide? ⇒ page 32 | Track Name? ⇒ page 34 | | | | | | | | | | |
| Combine? ⇒ page 32 | | | | | | | | | | | |
| 6 | <p>Cancel the edit mode. Press the MODE button before press the SELECT knob. Cancel the edit function. (after selected the edit item.) Press the MODE button before press the REC button.</p> | | | | | | | | | | |

| | |
|------------|---|
| 1-1 | <p>Set the cue mode at the position of the cue signal you want to erase. Press the CUE SERCH button.</p> <p>The cue direct search mode is set.</p> |
| 1-2 | <p>Press the STANDBY/CUE button.</p> <p>NOTE: Press the CUE button again to search for "Cue2", "Cue3", etc., and set the cue.</p> |
| 2 | <p>Select the cue erase edit function. (see page 30.) Select "Cue Erase?" and Press the SELECT knob.</p> |
| 3 | <p>Erase the cue signal. Press the REC button.</p> <p>The cue signal is erased and the mode returns to the edit mode.</p> |

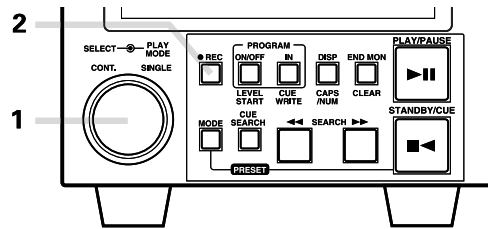
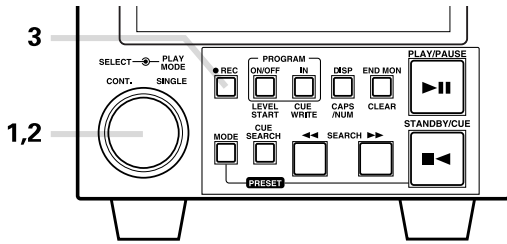

(4) Erasing Tracks
 «Track erase function»

(5) Erasing All the Tracks on the Disc
 «All erase function»

| | |
|----------|--|
| 1 | <p>Select the track erase function. (see page 30.) Select "Track Erase?" and press the SELECT knob.</p> |
| 2 | <p>Select the erase track. The track to be erased can be selected (or changed) by turning the SELECT knob.</p> |
| 3 | <p>Erase the select track. Press the REC button.</p> <p>The track is erased and the mode returns to the edit mode.</p> |

| | |
|----------|--|
| 1 | <p>Select the all erase edit function. (see page 30.) Select "All Erase?" and press the SELECT knob.</p> |
| 2 | <p>Erase all the tracks on the disc. Press the REC button.</p> <p>All the tracks are erased and the mode returns to the edit mode.</p> |

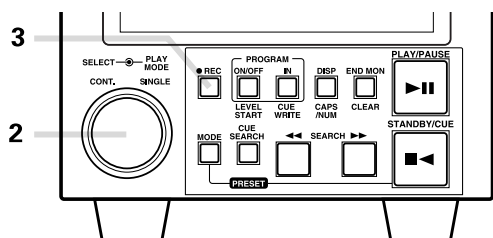

(6) Dividing Tracks into Two Parts
«Divide function»

| | |
|----------|--|
| 1 | <p>Use manual search, etc., to find the point at which you want to divide the track.</p> |
| 2 | <p>Select the divide edit function. (see page 30.) Select "Divide?" and press the SELECT knob.</p> <p>The section from three seconds before the divide point to the divide point is played repeatedly.</p> <p>NOTE: To move the divide point, press the SEARCH button.</p> |
| 3 | <p>Divide the track. Press the REC button.</p> <p>The track is divided and the mode returns to the edit mode.</p> |

NOTE:
 The divide operation cannot be performed if cue signals are set for that track.
 (Clear all the cue signals first.)

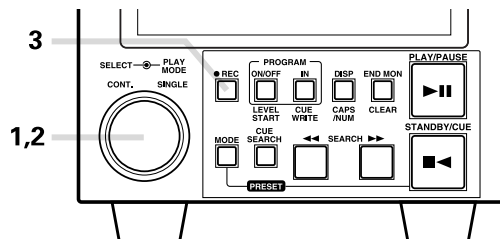

(7) Combining Two Tracks
«Combine function»



| | | | | | | | |
|----------|---|------|-----|--|--|------|------|
| 1 | <p>Select the combine edit mode function. (see page 30.) Select "Combine?" and press the SELECT knob.</p> | | | | | | |
| 2 | <p>Select the tracks to be combined. Use the select knob to set the cue mode at the second of the tracks to be combined.</p> <p>To combine tracks 02 and 03:</p> <table border="1" style="margin-left: auto; margin-right: auto;"> <tr> <td></td> <td style="text-align: center;">cue</td> <td></td> </tr> <tr> <td style="width: 30px;"></td> <td style="width: 30px; text-align: center;">02Tr</td> <td style="width: 30px; text-align: center;">03Tr</td> </tr> </table> | | cue | | | 02Tr | 03Tr |
| | cue | | | | | | |
| | 02Tr | 03Tr | | | | | |
| 3 | <p>Combine the tracks. Press the REC button.</p> <p>The tracks are combined and the mode returns to the edit mode.</p> | | | | | | |

NOTES:

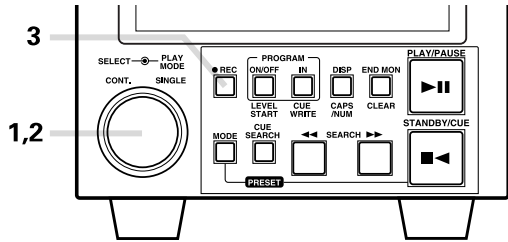
- If the tracks have track names, the name of the second track will be cleared.
- The following tracks cannot be combined:
 - 1) When cued at the first track
 - 2) A stereo track with a monaural track
 - 3) Tracks containing cue signals



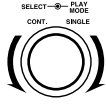

(8) Moving Tracks
«Move function»

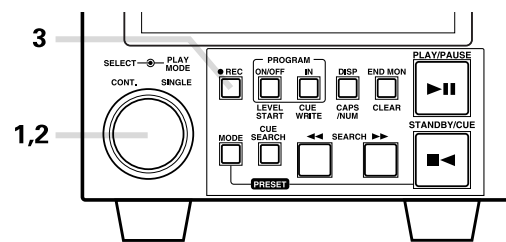
| | |
|----------|--|
| 1 | <p>Select the move edit function. (see page 30.) Select "Move?" and press the SELECT knob.</p>  <p>TRACK NO. 03 03_m 05.06_f 04 Move 03+03 Flashing</p> |
| 2 | <p>Use the SELECT knob to choose where to move which track. To move track 5 to track 1:</p>  <p>Move 03+03 ↓ Move 05+03 ↓ Move 05+03 Press the SELECT knob. ↓ Move 05+01</p> <p>Flashing</p> |
| 3 | <p>Move the track. Press the REC button.</p>  <p>Complete! ↓ Edit Mode Lit</p> <p>The track is moved and the mode returns to the edit mode.</p> |



(9) Pitch on the disc
«Disc's pitch function»

| | |
|----------|--|
| 1 | <p>Select the disc's pitch function. (see page 30.) Select "Pitch? **.*%" and press the SELECT knob.</p>  <p>TRACK NO. 03 03_m 05.06_f 04 Pitch OFF</p> |
| 2 | <p>Select the pitch. The pitch can be selected by turning the SELECT knob.</p>  <p>TRACK NO. 03 03_m 05.06_f 04 Pitch +0.1 Flashing</p> |
| 3 | <p>Write the pitch on the disc. Press the REC button.</p>  <p>Complete! ↓ Edit Mode Lit</p> <p>The pitch is written and the mode returns to the edit mode.</p> |

- Disc's pitch
 When preset 10 is set to "PitchAuto ON" and a disc on which the pitch is recorded is loaded, the recorded pitch is set automatically after the UTOC is read.

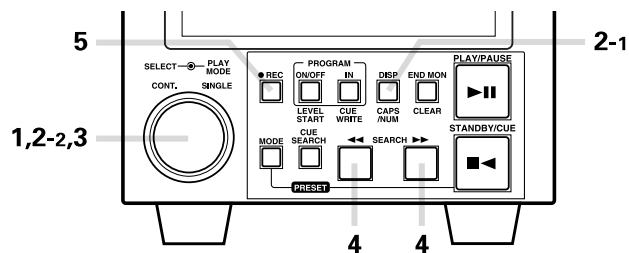

(10) Inputting (Changing) Names
«Title function»

| | |
|------------|---|
| 1 | <p>Select the name input edit item. (see page 30.) Select "Track Name?" or "Disc Name?" and press the SELECT knob.</p> <p>If a name is already set, the name is displayed and the first character flashes.</p> |
| 2-1 | <p>Select the type of characters to be input. Press the CAPS/NUM button and select the type of characters.</p> |
| 2-2 | <p>Turn the SELECT knob to select the character to be input.</p> |
| 3 | <p>Enter the selected character. Press the SELECT knob.</p> |
| 4 | <p>Continue inputting the name. Repeat steps 2-1, 2-2 and 3 to input the name. Press the SEARCH ◀◀ or ▶▶ button to move the cursor to change or correct a name. When the SEARCH ◀◀ or ▶▶ button is pressed, the cursor moves one space.</p> <p>Press the SELECT knob to insert characters, the CLEAR button to delete characters.</p> |

5

Set the name.
 Press the REC button.

The name is set and the mode returns to the edit mode.

Input Characters

The following letters, numbers and symbols (ASCII code) can be selected using the CAPS/NUM button and the select knob:

Capital letters
 SP ABCDEFGHIJKLMNOPQRSTUVWXYZ

Small letters
 SP abcdefghijklmnopqrstuvwxyz

Numbers
 SP 1234567890

Symbols
 SP ! " # \$ % & ' () * + , - . / : ; < = > ? @ [\] ^ _ ` { | } ~

SP _space

NOTE:
 Disc and track names can be up to 100 characters long, but the maximum number of characters that can be set for the disc name and all the track names is 1700.

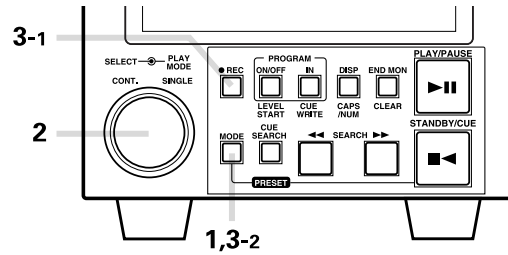
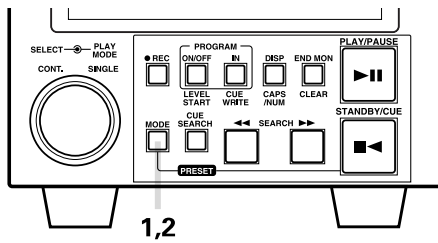

**(11) Exit the Edit Mode or Undoing Editing
(Undo functions)**

| | |
|----------|---|
| 1 | <p>Press the MODE button.</p> <ul style="list-style-type: none"> When editing is executed, the message "UTOC Write?" asking you whether or not you want to write the UTOC is displayed. The edit mode is canceled when editing is not being executed. |
| 2 | <p>Exit the Edit Mode. Write the UTOC EDIT.</p> <p>Press the REC button while UTOC Write? is displayed.</p> <p>The edit mode is canceled after the UTOC is written.</p> |

NOTES:

- The undo operation can be used to undo up to the two last editing operations. To undo previous editing operations, use the "First" operation to undo all the editing operations, then redo the editing.
- Once the UTOC is written or after the Names are inputed, it is not possible to change previous editings.
- If editing is performed when a program is set, the program is discarded.

| | |
|------------|---|
| 2 | <p>Select the undo mode.</p> <p>Turn the select knob.</p> <p>UNDO: For undoing the last editing operation. REDO: For resetting the editing undone with the undo function. FIRST: For undoing all the editing operations.</p> |
| 3-1 | <p>Undo the editing.</p> <p>Press the REC button.</p> <p>The editing is undone and the mode returns to the edit mode.</p> |
| 3-2 | <p>Cancel the undo mode.</p> <p>Press the MODE button before press the REC button. (Return to step 1)</p> |

9 CONNECTING AND OPERATING A KEYBOARD

An IBM PC compatible keyboard can be connected and used to control the DN-M991R.

Connectable keyboard: IBM US101 keyboard
(connector: 6-pin mini DIN PS/2 type)
Applicable cord: SCAN CODE SET 02

(1) Connecting the Keyboard

DN-M991R

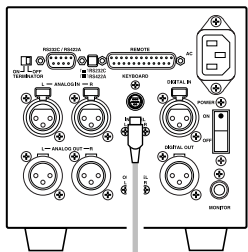

Keyboard

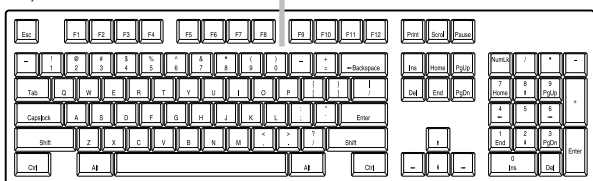

NOTE: Turn off the power of the DN-M991R before connecting the keyboard.

(2) Keyboard Operations

The keyboard's keys are allocated to specific DN-M991R panel operations. The functions of the keys differ according to the DN-M991R's operating mode.

- Functions of keys **F1** to **F12**

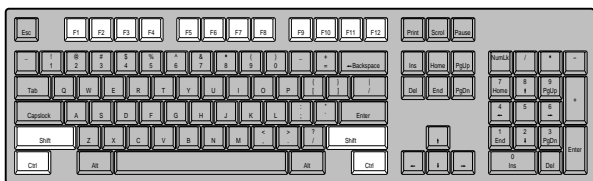

- F1** Track search reverse (1 track)
- F2** Track search forward (1 track)
- F3** PLAY/PAUSE button
- F4** STANDBY/CUE button
- F5** STOP button
- F6** REC button
- F7** Reserved
- F8** TIME button
- F9** PITCH button
- F10** PROG.PLAY ON/OFF button
- F11** CAPS/NUM button
- F12** END MON/CLEAR button

When the **Shift** key is held in while pressing keys **F1** to **F12**, the keys function as follows:

- F1** Track search reverse (10 tracks)
- F2** Track search forward (10 tracks)
- F3** Manual search reverse
- F4** Manual search forward
- F5** CUE SEARCH button
- F6** LEVEL START button
- F7** CUE WRITE button
- F8** Reserved
- F9** REPEAT button
- F10** PROGRAM IN button
- F11** Loads hot start data
- F12** TITLE IN button

When the **Ctrl** key is held in while pressing keys **F1** to **F12**, the keys function as follows:

- F1** PRESET button
- F2** Selects First in edit mode
- F3** Selects Redo in edit mode
- F4** Selects Undo in edit mode
- F5** MODE button
- F6** Selects DIVIDE in edit mode
- F7** Selects COMBINE in edit mode
- F8** Selects MOVE in edit mode
- F9** Selects Disc's pitch in edit mode
- F10** Selects Cue Erase in edit mode
- F11** Selects Track Erase in edit mode
- F12** Selects All Erase in edit mode

- Functions of other keys
 - 1) In normal operating mode

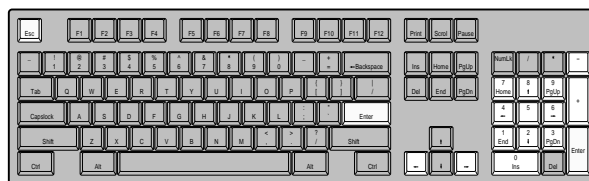

Numerical keypad keys Select tracks

- +** Pitch "+" button
- Pitch "-" button
- Increments track selection
- ←** Decrements track selection
- Esc** Cancels track selected with numerical keypad keys
- Enter** "PUSH ENTER" operation

NOTE:

Set the "Pitch" presetting to a setting other than "OFF" if you wish to change the pitch from the keyboard.

- When editing names

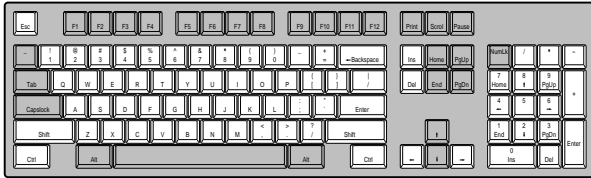

- Letter keys** Input small letters (when CapsLock is off)
- Number keys** Input numbers
- Symbol keys** Input symbols
- Numerical keypad keys** Input numbers
- +** Inputs “+” symbol
- Inputs “-” symbol
- Ins** Inserts character
- Del** Deletes character
- BackSpace** Deletes previous character
- Moves cursor one step to right
- ←** Moves cursor one step to left
- Esc** Cancels name input
- Enter** Enters input name (“PUSH ENTER” operation)

When keys are pressed while holding in the **Shift** key, the keys functions as follows:

- Letter keys** Input capital letters (when CapsLock is off)
- Number keys** Input symbols
- Symbol keys** Input (upper) symbols
- Numerical keypad keys** Input numbers
- Del** Deletes all characters after cursor
- Moves cursor to right end of display window
- ←** Moves cursor to left end of display window

When keys are pressed while holding in the **Ctrl** key, the keys functions as follows:

- Del** Deletes all characters
- Moves cursor to final character
- ←** Moves cursor to first character

- Hot start (optional function) data is load

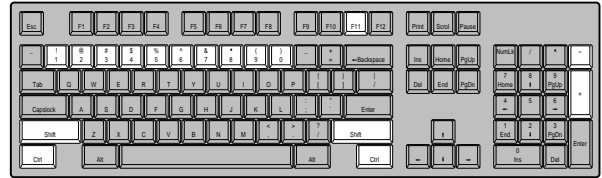

- Number keys** Hot start 1 to 10
- +** Pitch “+” button
- Pitch “-” button

When keys are pressed while holding in the **Ctrl** key, the keys functions as follows:

- Number keys** Reload data 1 to 10

When the **F11** key is pressed while holding in the **Shift** key, the hot start data is loaded.

- In the program mode

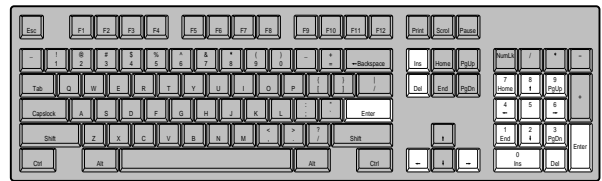

- Numerical keypad keys** Input tracks in the program
- Ins** Inserts track in program
- Del** Deletes track from program
- Increments track selection
- ←** Decrements track selection
- Enter** Enter: Set track (“PUSH ENTER” operation)

10 RESETTING THE MICROPROCESSOR

- A microprocessor controls disc drive unit, operation panel unit and the display.
- If for some reason the microprocessor should malfunction and the unit becomes inoperable, press the SELECT knob and the STANDBY/CUE button at the same time to reset the microprocessor.

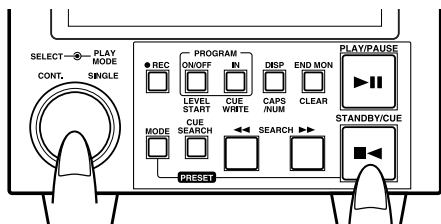

- When the microprocessor is reset, operation is restored to the same status as when the POWER switch is first turned on.

11 HANDLING CARTRIDGES

Discs are stored inside cartridges, so they can be handled easily without worrying about dust or fingerprints. Be careful of the following in order to keep recordings in optimum condition.

(1) Cautions on Handling

- Keep cartridges away from magnets and sources of strong magnetic forces. (Only for recordable discs)
- Put cartridges in their cases when carrying them.
- Do not apply labels other than the ones included when the discs are purchased.
- Use a soft, dry cloth to wipe any dirt off the surface of the cartridge.
- Do not open the shutter.
Forcing the shutter open could break it.
If the shutter is opened, dirt or dust may get inside and fingerprints may get on the disc.
- Do not bend, heat or throw cartridges.
- Water droplets may form on the surface if cartridges are moved suddenly from outside or any cold place to a warm place. If this happens, wait awhile before using them.

(2) Cautions on Storing

- Always remove cartridges from the set after recording or playing them.
- Do not put cartridges in the following places:
 - Places exposed to direct sunlight.
 - Hot places.
 - Humid or dusty places.

12 MESSAGES

Messages appear on the display when operating the set.
The meanings of the messages are described below.

| Message | Description |
|----------------|---|
| Can'tEdit ** | Indicates that editing was not possible. |
| Can'tIncrement | Indicates that the track number cannot be incremented by pressing the REC button during recording. |
| Can't Rec! | Recording is not possible because of a problem in the TOC recording enable data. |
| Complete! | Indicates that editing is complete. |
| Cue* | Indicates that the cue search operation is being performed. (* is the cue number.) |
| <Cue>***** | Displayed at the beginning of the track name if cue signals are set for that track. |
| Disc Full | There is no more remaining time on the disc, or there are already 255 tracks on the disc. |
| DiscType Err | Recording or editing is not possible with pre-mastered discs. |
| EEPROM Error | Displayed when changing the presets if there is a problem with the memory storage operation. |
| Error ** | Displayed when a system error occurs. |
| InitialError | Displayed if there is a problem with the memory storage operation when the presets have been reset (initialized). |
| Initial Set | Displayed when initializing the presets. |
| No Data | No hot start data. |
| No Name | Indicates that no track name or disc name has been set. |
| No Program! | Indicates that no program has been input. |
| No Sel.Track | Displayed when the selected track does not exist on the disc. |
| No Track | Indicates discs containing disc names but no tracks. |
| Not Audio! | Data other than audio data is input. |
| Now Cue Src! | Cue direct search mode is on. |
| Now H Start! | Hot start data is loaded. |
| Now Program! | This means that a program has been input. |
| Play Lock! | Displayed when a locked operation is performed when play lock is preset. |
| PresetProg*! | Program is preset. (* - 1 to 3) |
| Program Full | Displayed if you attempt to program a 26 th step. |
| Protected | Displayed when you attempt to record or edit while the cartridge is in the accidental erasure prevention mode. |
| Rec Mono | Sound will be recorded monaural. |
| Rec Stereo | Sound will be recorded stereo. |
| Track Full | Displayed when you attempt to set the recording mode on a disc containing 255 tracks. |
| UTOC Write? | Displayed when the MODE button is pressed. |
| UTOC Writing | Displayed while the UTOC is being written. |

13 SYSTEM LIMITATIONS

(1) Track Number Limits

- Up to 255 tracks can be recorded when recording the tracks successively starting from the first track on blank or no-track discs. In the following cases, however, the number of tracks that can be recorded decreases:
 - When editing has been performed.
 - When there are scratches on the disc and tracks have been re-recorded.

(2) Recording Time Limits

- Recording is performed in units of approximately 2 seconds. Sections of less than 2 seconds still take up 2 seconds worth of space on the disc, so this decreases the actual recordable time.
- Scratched sections of discs are automatically eliminated from the recording time.
- Recording is no longer possible once the maximum number of tracks is reached, even if they take up less than the maximum recordable time. To record on such discs, first erase unneeded tracks. When this is done, it is not possible to record for longer than the time of the tracks that have been erased.
- The remaining time on the disc may not increase when short tracks (less than approximately 8 seconds) are erased.
- If there are many emphasis data on/off signals or other similar signals in a track, they are treated as divisions between tracks, so recording will not be possible regardless of the recording time and number of tracks.
- Track incrementing may not be possible if it is conducted (automatically or manually) consecutively within less than 2 seconds.

(3) Editing Function Limits

- It may not be possible to combine a short track with another track.
- Tracks containing cue points cannot be divided or combined.

(4) Title Function Limits

- There are limits to the number of characters that can be used in disc and track names and to the total number of characters used for both. When writing names, the cursor will only move by the maximum number of writeable spaces. (after this no more characters can be input.)

| | |
|--------------|-----------------------|
| Track names: | Up to 100 characters |
| Disc names: | Up to 100 characters |
| Total: | Up to 1700 characters |
- The number of characters that can be used in track names decreases when the following functions are used:

| | |
|----------------------|---|
| Cue point function: | Using one point decreases the number of characters that can be used by 10. |
| Play speed function: | Changing the play speed decreases the number of characters that can be used by 6. |

CAUTION:

Because cue points are stored on the disc as name inputs, it may not be possible to input names if many cue points are set on discs with many tracks, and if many names are used it may not be possible to store cue points.

- When a track with a track name is divided, both of the divided tracks are given the same name. However, if the number of characters writeable on the disc is near the limit, the second track may only have part of the track name.
- When two tracks with track names are combined, the name of the second track is erased.

(5) Other Limits

- In the program play mode, the record mode is not set even when the REC button is pressed. If the REC button is pressed, "Now Program!" is displayed for approximately 1 second, then turns off.
- In the program play mode, the editing mode is not set even when the MODE button is pressed. If the MODE button is pressed, "Now Program!" is displayed for approximately 1 second, then turns off.
- In the editing mode and during hot start loading, the program play mode is not set even when the PROGRAM ON/OFF button is pressed.
- If the REC button is pressed while hot start data is loaded, "Now H Start!" is displayed for 5 seconds. If the REC button is pressed while "Now H Start!" is displayed, the recording pause mode is set. (The hot start data is cleared.)

14 SPECIFICATIONS

GENERAL

| | |
|-----------------------------------|--|
| Type: | MiniDisc Recorder |
| Recordable/Playable Discs: | Playback: Pre-mastered MDs and recordable MDs Recording: Recordable MDs |
| Recording System: | Magneto-optical overwriting system (Magnetic field modulation) |
| Signal Compression System: | ATRAC (Adaptive Transform Acoustic Coding) version 4.0 |
| Rotating Speed: | Approx. 400 to 900 rpm. |
| Recording/playback time: | 74 min. (Stereo), 148 min. (Mono) |

AUDIO SECTION

| | |
|-----------------------------------|--|
| Channels: | 2 channels (Stereo), 1 channel (Mono) |
| Sampling Frequency: | 44.1 kHz |
| Quantization Bits: | A/D converter: 16 bit, D/A converter: 18 bit |
| Frequency Response: | 20 to 20,000 Hz (± 1.0 dB) |
| Total Harmonic Distortion: | 0.015 % or less (Playback, A filter) 0.035 % or less (Recording, A filter) |
| Signal to Noise Ratio: | 100 dB or higher (Playback, A filter) 84 dB or higher (Recording, A filter) |
| Channel Separation: | 90 dB or higher (Playback, A filter) 80 dB or higher (Recording, A filter) |
| Analog Output: | (1 kHz, 0 dB playback) |
| Connector: | XLR connector |
| Output Level: | +18 dBs, 600 Ω /ohms |
| Monitor Output: | 20 mW or greater (30 to 40 Ω /ohms) |
| Analog Input: | |
| Connector: | XLR connector |
| Input Level: | +18 dBs, 10 k Ω /kohms |
| Digital Output: | |
| Connector: | XLR connector |
| Signal Format: | AES/EBU or IEC-958 Type I |
| Output Level: | 3 Vp-p or greater, 110 Ω /ohms |
| Digital Input: | |
| Connector: | XLR connector |
| Signal Format: | AES/EBU or IEC-958 Type I |
| Input Level: | 3 to 10 Vp-p, 110 Ω /ohms |
| Variable Pitch Control: | ± 8 % |
| Audio Start-up Time: | 0.03 second less |
| Frame Search Accuracy: | 1 frame (1/86 second) |

DIMENSIONS

| | |
|----------------------|---|
| Without feet: | 144 (W) x 133 (H) x 401 (D) (5-43/64" x 5-15/64" x 15-25/32") |
| With feet: | 144 (W) x 146 (H) x 401 (D) (5-43/64" x 5-3/4" x 15-25/32") (Not including feet, dials and terminals) |

WEIGHT

| | |
|-----------------------|--------------------|
| Recorder unit: | 5.0 kg (11.02 lbs) |
|-----------------------|--------------------|

POWER CONSUMPTION:

22 W

POWER SUPPLY:

AC 120 V ± 10 %, 60 Hz (U.S.A. & Canada)
AC 230 V ± 10 %, 50 Hz (Europe, Asia & Others)

ENVIRONMENTAL CONDITIONS

| | |
|-------------------------------|------------------------------|
| Operating Temperature: | +5 °C to 35 °C |
| Humidity: | 25 % to 85 %, non condensing |
| Storage Temperature: | -20 °C to 60 °C |

* Specifications and design are subject to change without notice for purpose improvement.

US and foreign patents licensed from Dolby laboratories Licensing Corporation.