

 **BLACK & DECKER®**

All-In-One Deluxe™ Automatic Breadmaker

Operating Instructions & Cookbook



***Delicious Home Baked Bread Has Never Been Easier!
B1620***

Questions? Please call us Toll Free!

In Canada 1-800-465-6070 In The United States 1-800-231-9786

Important Safeguards



When using electrical appliances, basic safety precautions should always be followed, including the following:

Read all instructions.

- Do not touch hot surfaces. Use handles or oven mitts.
- To protect against a risk of electric shock, do not immerse cord, plug, or other parts of this Breadmaker in water or other liquid, except the Mixing Paddle, which may be immersed when removed from the Baking Pan for cleaning.
- Close supervision is necessary when any appliance is used by or near children.
- Unplug from outlet when not in use and before cleaning. Allow to cool before cleaning, putting on, or taking off parts.
- Do not operate any appliance with a damaged cord or plug or after the appliance malfunctions or has been dropped or damaged in any manner. Return the appliance to an authorized service center for examination, repair, or adjustment.
- The use of accessory attachments not recommended by the appliance manufacturer may cause injuries.
- Do not use outdoors.
- Do not allow cord to touch hot surfaces or hang over the edge of table or counter.
- Do not place on or near a hot gas or electric burner, a heated oven, or on top of a microwave oven.
- Extreme caution must be used when moving an appliance containing hot contents or liquids.
- To turn off, disconnect from outlet by grasping the plug. Do not yank on cord.
- Do not use Breadmaker for other than intended use.
- Do not use Breadmaker for storage purposes nor insert any utensils as they may create a risk of fire or electric shock.
- Avoid contact with moving parts.

- Do not remove the Baking Pan during operation. Press START/RESET and hold until you hear a beep if you need to stop operation.
- Do not pour any ingredients directly into the Breadmaker—only into the Baking Pan. It is important to remove the Baking Pan from the unit before putting ingredients into the Pan (except when using the “Add-Ingredient” function, see pg. 10) to avoid accidentally spilling ingredients into the oven chamber.
- Before operating, the Baking Pan must be in place to avoid electric shock.
- Place the Breadmaker at least 2 inches away from any walls or from under cabinets to allow for steam from vents.
- Do not cover the Breadmaker with towels or other material that may prevent steam from escaping. Some steaming from vents is normal.
- Do not clean with scouring pads. The Baking Pan and Mixing Paddle have a non-stick coating. Refer to the “Care and Cleaning” section of this book.
- Do not operate in the presence of explosive and/or flammable fumes.
- This product is intended for household use only and not for commercial or industrial use.
- To avoid damaging the machine, do not place the Baking Pan or any other object on top of the unit.

Save These Instructions

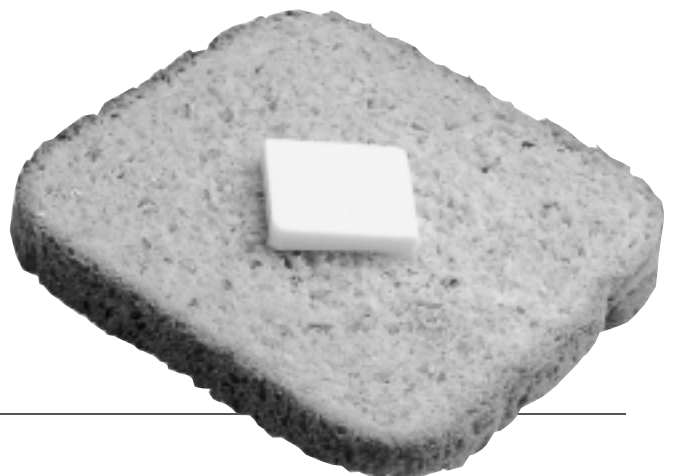

Important Safeguards



Things You Should Know About Your Breadmaker

POLARIZED PLUG

This appliance has a polarized plug—one blade is wider than the other. To reduce the risk of electric shock, this plug will fit into a polarized outlet only one way. If the plug does not fit fully into the outlet, reverse it. If it still does not fit, contact a qualified electrician. Do not attempt to defeat this safety feature by modifying the plug in any way.

TAMPER-RESISTANT SCREWS

This appliance is equipped with tamper-resistant screws to prevent removal of the outer cover. To reduce the risk of fire or electric shock, **do not attempt to remove the outer cover**. There are no user-serviceable parts inside. Repair should be done **only** by authorized service personnel (see insert for a list of Black & Decker Company-Owned or Authorized Service Centers).

ELECTRICAL CORD

The cord length of this appliance was selected to reduce safety hazards that may occur with a longer cord. If more cord length is needed, an extension cord with a polarized plug may be used. It should be rated not less than 10 amperes, 120 Volts, and have Underwriters Laboratories (U.L.) or Canadian Standards Association (CSA) listing, depending on the country. When using a longer cord, be sure it does not drape over a working area or dangle where it could be pulled on or tripped over. Handle cord carefully for longer life; avoid jerking or straining it at outlet and appliance connections.

BEFORE FIRST USE

There's nothing like the aroma of fresh-baked bread. With the Black & Decker All-In-One Deluxe™ Automatic Breadmaker, you can have the old-fashioned goodness of homemade bread with today's automatic convenience. That's because the All-In-One Deluxe™ Breadmaker does the work for you. Even if you've never made homemade bread before, you'll rise to the occasion with this Breadmaker.

Please take a few minutes to read this Use & Care Instruction/Cookbook and to find a place to keep it handy for reference. Pay particular attention to the safety instructions provided for your protection. Review the product warranty and service statements and fill out and mail in the owner registration form.

Carefully unpack the Breadmaker and remove all packaging materials. To remove any dust that may have accumulated during packing, wipe the Baking Pan, Mixing Paddle, and outside surface of the Breadmaker with a clean, damp cloth. Do not use scouring pads or any abrasives on any part of the Breadmaker.



Table Of Contents



Important Safeguards	2
<i>Polarized Plug</i>	3
<i>Tamper-Resistant Screws</i>	3
<i>Electrical Cord</i>	3
<i>Before First Use</i>	3
Getting To Know Your Breadmaker	5
<i>Quick Tips</i>	5
Names of Parts	5
Control Panel Settings & Functions	6
Bread Type Setting Descriptions	6
How to Use Your Breadmaker	7
<i>Using the “Add-Ingredient” Function</i>	10
<i>Setting the Timer</i>	10
<i>Troubleshooting</i>	11
<i>Troubleshooting Guide</i>	12
<i>Slicing & Storing Bread</i>	13
Care & Cleaning	13
<i>Storing the Unit</i>	13
<i>Easy-Lift Grips</i>	14
Service or Repair	14
<i>Full Two-Year Warranty</i>	14
COOKBOOK SECTION	
Bread and Dough Ingredients	16
<i>Tips for Getting the Best Results</i>	17
<i>Tips for Handling Dough</i>	17
Recipe Index	18
Recipes	19
Need Help? (Questions and Answers)	31
1-800 Number	33

Getting To Know Your Breadmaker



Quick Tips

- Your breadmaker makes large 1.5 or extra large 2 lb loaves.
- There are five settings including one for dough or pasta.
- The “Rapid Bake” setting can produce **variations of basic white bread** in less than 2 hours. This setting can only be used with recipes supplied (see pg. 20). **You cannot use the timer** with this selection. This setting cannot handle heavier recipes such as whole grain because of its shortened rising cycle.
- Depending on the recipe you select, the “Dough/Pasta” setting will let you produce dough that can be shaped into dinner rolls, pizza, long loaves, challah, pretzels, filled braids, or more. For Pasta, be sure to use pasta or semolina flour. Pasta dough should be processed through a pasta maker or pasta shaper to form the desired shape. Consult the Cookbook section of this manual.
- The Crust Control function lets you choose “Regular” or “Dark” crust on the Basic, Rapid Bake, or Sweet settings. It cannot be used on the Whole Grain or Dough/Pasta settings.
- The “Keep Warm” function begins automatically after bread is baked. It keeps baked bread warm up to an hour after the baking is done. This function stops after 60 minutes or when the unit is unplugged, or the Start/Reset button is pressed.
- An “Add-Ingredient” function signals with beeps when it’s time to add ingredients such as fruits or nuts to recipes used with any setting except Rapid Bake. A beep signals before kneading is completed to let you know when to add ingredients. This feature helps keep fruit or nuts whole (See “Add-Ingredient Function” pg. 10 for more details). If you use the TIMER to delay baking, you may add all ingredients at once and bypass this function, however, your fruit or nuts may get “chopped” and blended into the bread.
- Do not cover the breadmaker with towels or other material that may prevent steam from escaping. Some steaming from vents is normal. Because of escaping steam, you should keep the breadmaker several inches away from cabinets while making bread.
- Do not place any objects on top of the breadmaker.
- **IMPORTANT: Add ingredients in the order they are specified in the recipe. For best results, accurate measuring of ingredients is very important.** Do not put larger quantities than recommended into the Baking Pan as it may produce poor results and may damage the breadmaker.

Names Of Parts

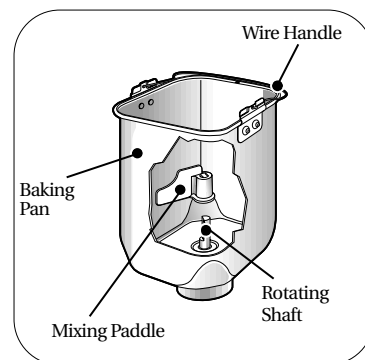
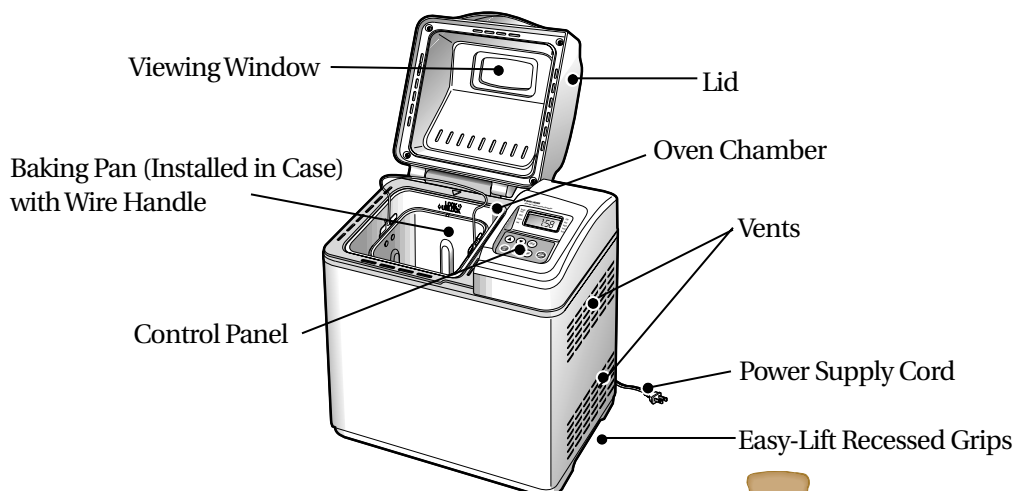

Control Panel Settings & Functions



BLACK & DECKER
All-In-One™ Deluxe Automatic Breadmaker



NOTE: When using the touch pad control, be sure to press the pad until you hear a beep.

1. Display

- The black arrow at the right side of the display indicates your bread setting choice; the left side arrow indicates the Dough/Pasta setting and Crust Color choices.
- When set, the digital clock will show either the current time of day, or, when the breadmaker is operating, the time it will take for your bread to be completed under the selected setting.
- Shows minute-by-minute time countdown.
- Indicates troubleshooting message in the Window (see “Troubleshooting” pg. 11)

2. Clock Button

Use when setting the current time of day.

- The CLOCK button is used with the “Up” and “Down” arrows to set the 12 hour “AM” or “PM” digital clock.

3. Timer Button

Use when setting the TIMER to delay baking.

- The TIMER button is used with the “Up” and “Down” arrows to set the time you wish your bread to be complete (up to 13 hour delay).

4. Start/Reset Button

- Press to start operation and to display the time it will take for your bread to be completed under the selected setting.
- Press and hold to cancel the breadmaking operation. The red “on” light goes out & unit beeps (DO NOT press when you are just checking the progress of your bread or you will cancel your program).

5. Indicator Lights

- The red “on” light indicates that the breadmaking operation has started. When the cycle is complete, the red light will flash for 60 minutes in its “Keep Warm” cycle. If you do not remove the bread after 60 minutes, it will simply remain on to show you that the unit is still plugged in.
- The green “timer” light indicates that the timer function is on. When the actual breadmaking operation begins, the green light will go off, and the red light will come on.

Bread Type Setting Descriptions

NOTE: The number in parentheses following each setting description represents the total baking time. Each setting begins with a preheat period which delays the mixing cycle until the desired temperature is reached within the oven chamber. The preheat cycle does not add time to the Bread program.

BASIC BREAD/Regular Crust or BASIC BREAD/Dark Crust (3:50 hours)

This setting is used for breads which primarily use

white flour, though some recipes may include small amounts of whole wheat flour as well. In the U.S., be sure to use Bread Flour; in Canada, you may use Canadian All-Purpose Flour or Bread Flour. Follow recipes carefully. Basic Bread/Regular Crust will produce good results when you are using ingredients such as cheese, nuts, or cornmeal as they tend to brown easily. Choose Basic Bread/Dark Crust, to produce a loaf with a darker crust without lengthening the baking time.

Bread Type Setting Descriptions



RAPID BAKE/Regular Crust or RAPID BAKE/Dark Crust (1:58 hours)

This setting is used **only** to make variations of **basic white bread** quickly whether you choose a “Regular” or “Dark” crust. **Refer to the recipe section of this booklet for a complete list of all recipes that can be used with this setting.** This setting cannot be used successfully to make breads other than those specified due to the shorter rising time of this cycle.

SWEET/Regular Crust or SWEET/Dark Crust (3:50 hours)

Use this setting for recipes that use fruit juice, large amounts of sugar, cheese, or added sweet ingredients such as raisins, dried fruit, or chocolate. Baking temperature is lower to prevent burning.

WHOLE GRAIN (4:10 hours)

This setting is used for recipes with significant amounts of whole wheat or rye flour, oats, or bran. This setting has a longer rise cycle and preheat cycle to allow heavier grains to expand. Generally, whole wheat/multi-grain breads are shorter and denser than Basic or Sweet breads. **You cannot use the Crust Color selections** with this setting.

DOUGH/PASTA (2:00 hours)

This setting makes bread-style dough and pasta dough. Dough can be shaped to make pizza, rolls, pretzels, long loaves or braids that must then be baked in a conventional oven. It can also prepare pasta dough that must then be processed and shaped through a pasta maker. Pasta dough should be removed from the Breadmaker after the “Add-Ingredient” signals (in 40 - 45 minutes). Follow pasta recipes on page 30 for specific directions.

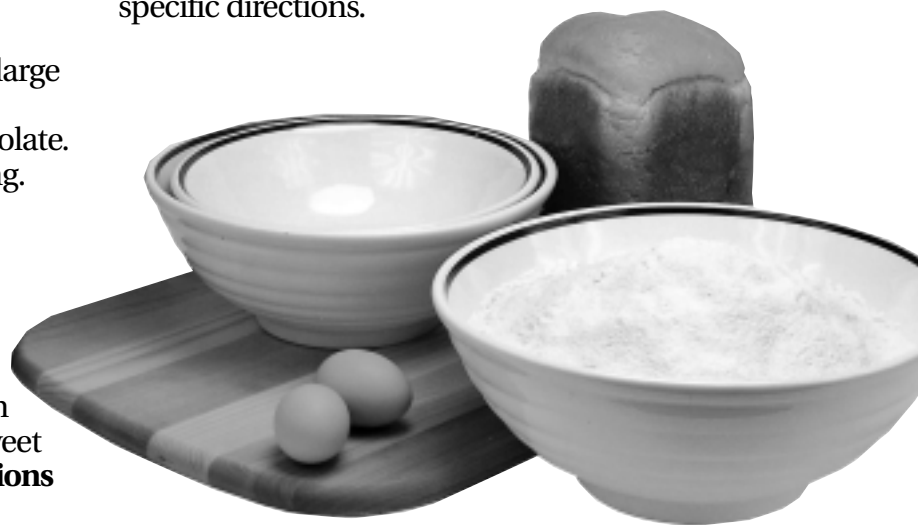

How To Use Your Breadmaker

The four bread making settings in this unit will combine ingredients, knead, and bake bread from start to finish – automatically. The Dough/Pasta setting makes dough for a variety of recipes but you must shape and bake the dough yourself in a conventional oven or process it in a pasta maker. To delay completion, the Automatic Timer may be programmed to make bread while you are at work or asleep. (See “Setting the Timer” pg. 10)

The Cookbook section of this book includes recipes that have been thoroughly tested in Black & Decker’s own test kitchen to ensure best results in both the United States and Canada. Flours, cornmeal, and a few other ingredients vary widely between the two countries.

NOTE: The term, “All-Purpose Flour” for example, is applied to two totally different types of flour depending on whether it is purchased in the U.S. or Canada. Canadian “All-Purpose Flour” will produce

good to excellent results in this Breadmaker; whereas American “All-Purpose Flour” will produce poor results.

Therefore, each recipe is presented with two sets of ingredients –one for each country. Since ingredients are different, it is important that you double check to be sure you are following the recipe appropriate for ingredients in your country (U.S. or Canada) before using your Breadmaker.

Most North American national brand flours and yeasts will produce good results. Keep in mind that the recipes included here have been created by our Home Economists specifically for this automatic breadmaker (Model B1620) and may not produce acceptable results in other similar breadmakers.

How To Use Your Breadmaker



For all SETTINGS (including Dough/ Pasta) follow these instructions:

1 Open the lid, grasp the wire handle with two hands, and turn the Baking Pan to the left “Unlock” position, then remove it by pulling straight up on the handle. It is important to remove

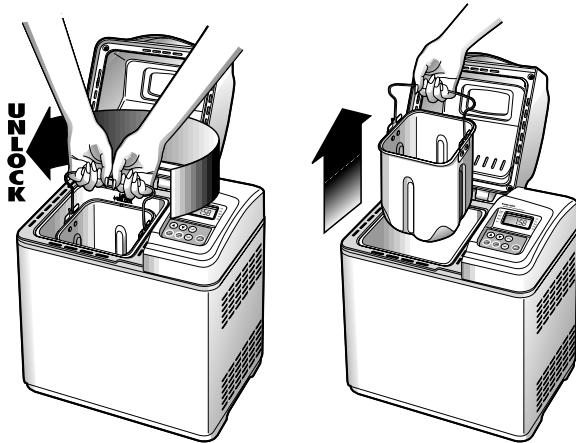

the Baking Pan from the unit rather than add ingredients into the Pan while it is in place to avoid accidentally spilling ingredients into the oven chamber.

2 Attach the Mixing Paddle onto the shaft inside the Baking Pan by lining up the flat side of the Paddle with the flat side on the shaft. Gently push the Paddle onto the shaft.

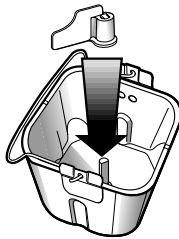

3 Select a recipe from the Cookbook section of this booklet. When following the recipe:

- **Always add ingredients into the Baking Pan in the order they are listed.**
- **Measure ingredients carefully & accurately. To measure liquids, use a see-through measuring cup and check the measurement at eye level.**
- **When measuring dry ingredients, use standard dry measuring cups or measuring spoons and level off the ingredients with the straight-edge of a knife or metal spatula.**

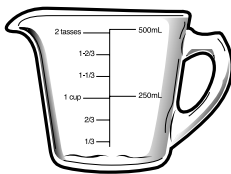

Inaccurate measurements, even if only slightly off, can make a difference in results.

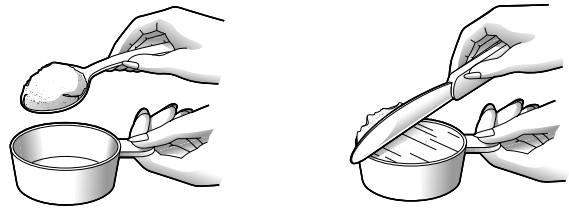

- **Yeast is always added last. Be sure that the yeast does not touch the liquid ingredients, salt or shortening.**

4 The Baking Pan can be installed in TWO POSITIONS. There are notches on two sides of the rim of the Baking Pan. Be sure to have a notched side facing toward you when you put the Pan into the oven chamber. Place the Baking Pan into the unit in a left diagonal position as illustrated. Using both hands, rotate the Pan in a clockwise

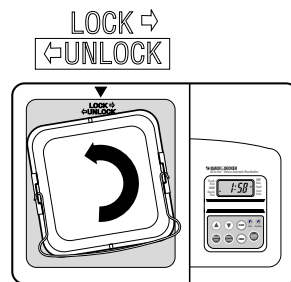
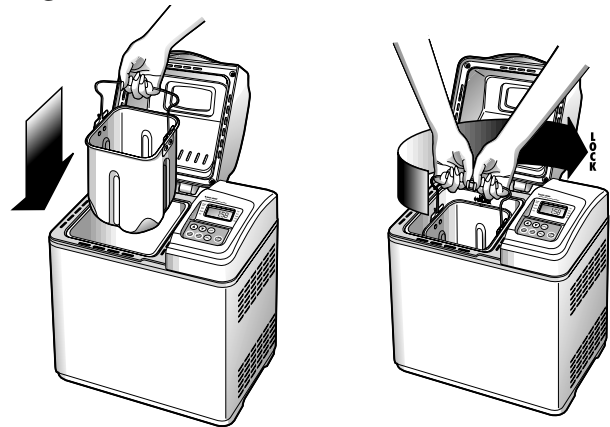

TOP VIEW
UNLOCKED

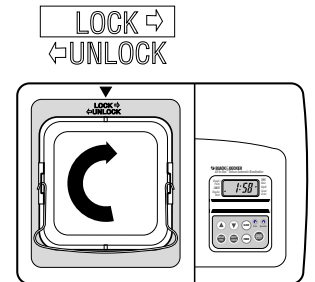

TOP VIEW
LOCKED

direction until the notch on the Pan lines up with the raised pointer located on the top surface of the oven chamber. Fold the handle down and click into place.

How To Use Your Breadmaker



5 Close the lid and plug into an outlet (120 volt). Two ARROWS will come up in the display window indicating BASIC BREAD TYPE with a REGULAR crust and 12:00 AM will flash in the display window. If you wish to use the TIMER to delay baking, you will first have to set the correct time of day. However, if you want to start the breadmaking operation now, it is not necessary to set the CLOCK.

6 To bake a Basic loaf of bread with a Regular Crust, simply press the START/RESET Button.

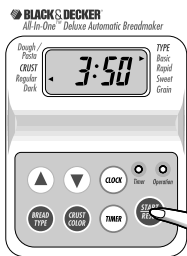

However, you can choose a different setting for your recipe by pressing the BREAD TYPE button on the pad. Each time you press BREAD TYPE, the arrow in the display window will point to the next selection (i.e. Rapid Bake, Sweet Bread, etc.) If you are using a recipe that calls for the Basic, Rapid Bake, or Sweet Bread setting, choose a crust color by pressing the CRUST COLOR button until the arrow in the window lines up with either "Regular" or "Dark."

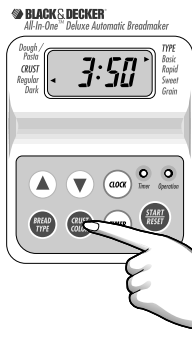

Basic, Rapid Bake, or Sweet Bread setting, choose a crust color by pressing the CRUST COLOR button until the arrow in the window lines up with either "Regular" or "Dark."

7 Press the START/RESET Button once until it beeps and the red "on" indicator light comes on.

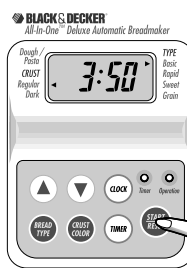

The flashing 12:00 AM will be replaced by, for example, 3:50, if you chose a recipe for the Basic Bread setting (regardless of whether you chose "Regular" or "Dark" crust). It will count down the remaining time in one-minute intervals (3:49, 3:48, etc.) until the bread is done. When

the baking is complete, several beeps will sound to alert you that the bread is ready and the red indicator light will begin flashing. In addition, a flashing 12:00 AM will reappear in the display screen.

8 This Breadmaker is designed with a **Keep Warm** function that automatically begins when baking is complete. The red light will continue to flash for up to 60 minutes after baking is complete and will

keep bread warm during that time. At the end of the hour, the **Keep Warm** cycle will end and the light will remain on constantly, indicating the unit is still plugged in. The bread should then be removed as soon as possible to avoid getting soggy. You may remove the Baking Pan any time during the **Keep Warm** cycle. To turn off the **Keep Warm** feature before the 60 minutes are up, simply press the START/RESET button and hold it until the display time clears.

NOTE: The **Keep Warm** feature does not function for the DOUGH/PASTA setting since baking is not involved in this program. If you leave finished dough in the unit over a period of time, it may over-rise and produce poor results. For best results, remove dough at the end of the program and follow the recipe directions for shaping, rising, and baking.

9 This unit has a convenient Viewing Window so that you may watch the progress of the bread as it is mixed, kneaded, and baked. Occasionally, some moisture may form in the window during the rising cycle. If moisture forms, you may lift the lid to look inside during the mixing and kneading stages, however, DO NOT OPEN THE LID DURING THE BAKING CYCLE (approximately the last hour) as this may cause the bread to underbake. Most of the moisture should disappear during the baking cycle.

10 To remove the Baking Pan, use pot holders or oven mitts, grasp the wire handle with both hands and turn the Pan to the left until the notch in the pan lines up with the unlock arrow on the back wall of the oven chamber. Pull straight up on the Baking Pan. Fold and lock the wire handle down. Turn the pan on its side and gently shake the bread out onto a wire cooling rack. The Baking Pan and Mixing Paddle have a non-stick coated finish so that the bread should come out easily. Do not use metal utensils to remove bread as they may scratch the non-stick coating. If you have difficulty removing bread from the Baking Pan, slide a flat rubber or



How To Use Your Breadmaker



plastic spatula along the sides of the pan to loosen the loaf. Turn the pan over and shake the loaf out. Allow the bread to cool before slicing. If the Mixing Paddle remains in the bottom of your loaf, allow the loaf to cool then use a plastic

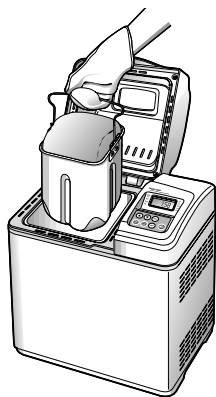

spoon or rubber spatula to remove the paddle. Do not use a knife or other sharp metal object as this will scratch the non-stick coating on the Mixing Paddle.

Using The “Add-Ingredient” Function

1 All settings, except for Rapid Bake, have a built-in “Add-Ingredient” function which signals with beeps when it’s time to add ingredients such as fruits or nuts. The beeps sound before kneading is complete to let you know it’s time to add the ingredients. The actual time of the beeps can vary up to 5 minutes depending on the room temperature at the time when you started the bread making program. The following chart can be used for reference:

<u>Setting Signals</u>	<u>When to add Ingredients after Starting Program</u>	<u>Time Displayed when Beeper Signals</u>
Basic Bread	30-35 minutes into program	3:15-3:20
Sweet Bread	30-35 minutes into program	3:15-3:20
Whole Grain	37-42 minutes into program	3:28-3:33
Dough	40-45 minutes into program	1:15-1:20

2 This function lets you add ingredients so that they don’t get chopped up by the Mixing Paddle and blended into your loaf. If you are using the TIMER to delay baking (perhaps while you are asleep or away from home), you may bypass this function by ignoring the signal and adding ingredients in the order called for in the recipe, however, you may end up with somewhat broken pieces.

3 To add ingredients, raise the lid and carefully pour the ingredients into the Baking Pan. **CAUTION: It is important to avoid spilling ingredients into the oven chamber.**

Setting The Timer (For Delayed Completion)

Use the TIMER when you would like to delay the completion of your bread or dough/pasta. This feature allows you to delay bake time for up to 13 hours. For example, it lets you set the TIMER at 7 p.m. one evening so that you can wake to fresh bread by 8 a.m. the following morning. **NOTE: The TIMER cannot be used with the Rapid Bake setting.**

To set the TIMER, follow these instructions:

NOTE: Be sure you have followed the “How to Use Your Breadmaker” steps 1-6 in preparing the ingredients in the Baking Pan. It is not recommended that you use the “Delayed Completion” function and TIMER with recipes that call for fresh ingredients that might spoil such as eggs, fresh milk, buttermilk, or cheese.

1 To use the TIMER, you must first set the digital clock to the correct time of day. To change the flashing 12:00 AM, first press the CLOCK button. **While the “12” is flashing**, the hour can be set by **immediately** pressing the “Up” and “Down” arrows to change the time in 1 hour intervals. Make sure the “AM” or “PM” displayed is appropriate. **While the correct hour is flashing** in the display, press the CLOCK button again to set the minutes. If the hour display has stopped flashing before the minutes have been set, press the CLOCK button twice. **While the “00” is flashing**, the minutes can be set by pressing the “Up” and “Down” arrows. You may hold either arrow to rapidly change the time in 5 minute intervals, or press and release to change 1 minute at a time.

2 **Once the clock is set**, the TIMER can easily be set following similar steps. To wake up to the aroma of fresh baked bread at 8:30 AM for example, press and hold the TIMER button until appears on the display, and the “12” of 12:00 AM flashes as it did when setting the clock above. **While the “12” is flashing**, press the “Up” or “Down” arrows to change the “12” to “8”, checking to make sure “AM” is displayed. To set the minutes, press the TIMER button

How To Use Your Breadmaker



while the hour setting is flashing. If the hour setting has stopped flashing before the minutes have been set, press and hold the TIMER button. With the hour setting flashing again, immediately press the TIMER button to set the minutes. **While the “00” is flashing,** the minutes can be set to “30” using the “Up” or “Down” arrows. When the “30” stops flashing and the current time is displayed, the timer is set.

3 To start the delayed completion timer, press the TIMER button. The completion time will flash **briefly** and be replaced by the current time in the display, and the green TIMER light will come on. If the green light does not come on, and “13 Hr [TIMER] [ERR]” appears on the display, you have set the TIMER for longer than the maximum 13 hour delay. To reset the TIMER hold the TIMER button until the hour setting flashes, and the time can be changed using the “Up” and “Down” arrows. If the green light does not come on, and “0 Hr [TIMER] [ERR]” appears, the TIMER has been set for a delayed completion time which is shorter than the actual bake time (for example 3:50 is the bake time for Sweet Bread). Reset the TIMER for a longer delayed completion time.

4 To cancel the TIMER function, press the TIMER button and the green light will go out.

5 To check the completion time while the green TIMER light is on, press the TIMER button twice. To check the completion time while the red light is on, press the TIMER button once.

6 When the actual breadmaking operation begins, the green “timer” light will go out, the red “on” light will come on, and total bake time (3:50 for Sweet Bread) will appear on the display. The bake time will count down in one minute intervals. When the end of the countdown is reached, a beeping signal will sound and your bread is complete. The red light will now begin flashing to show the Breadmaker has automatically activated the 60 minute “Keep Warm” function.

Troubleshooting

Specific questions about the breadmaker functions and problems with ingredients or recipes are addressed in the “Need Help?” section beginning on pg. 31.

- If there is an operational problem with the unit, you may see a hyphen, colon, double hyphen (- : --) message in the display window.

This means there is an operational/mechanical malfunction. **DO NOT USE THE UNIT.** Unplug the unit and contact your local service center for repair. Call the toll-free number on the cover of this booklet to ask for the location of the Black & Decker service center nearest you.

- If the START/RESET button is pressed and the word “HOT” appears in the display window, it indicates that the unit has not cooled sufficiently after baking to use immediately again. Open the lid, remove the Baking Pan and allow the inside of the unit to cool. Once the unit has cooled sufficiently, pressing the START/RESET button will immediately start the breadmaking operation.
- For specific problems with Bread/Dough results, see the Troubleshooting guide on the next page:

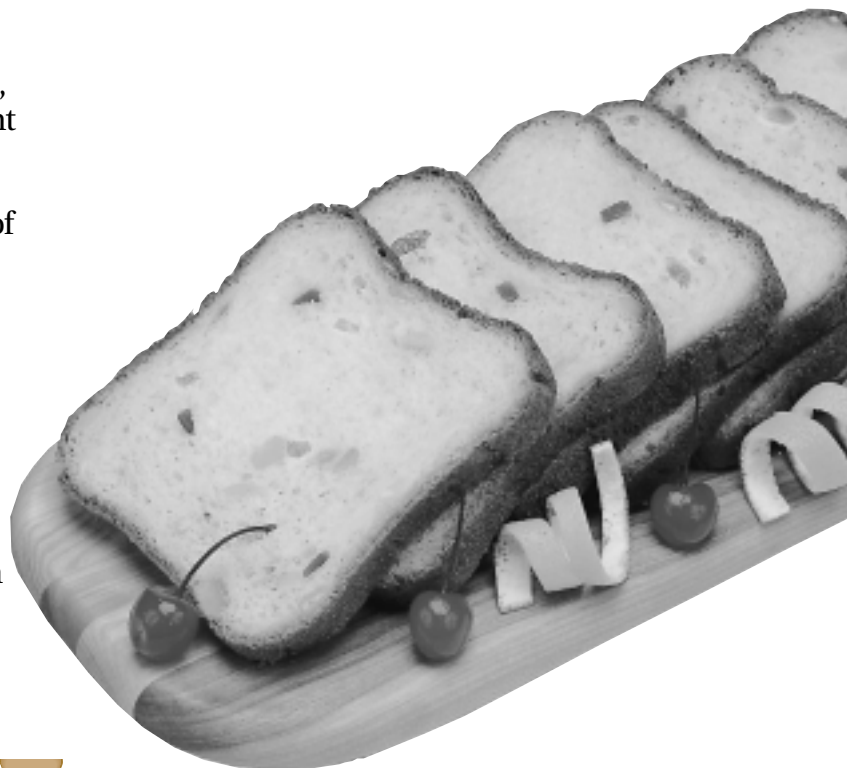

Troubleshooting Guide



NOTE: The number one cause for poor results is improper measurement of ingredients (see page 8). The checklist below offers several possible solutions. Try one adjustment at a time and only make one change per loaf. If results do not improve with the first adjustment, move to the next possible solution.

RESULTS →		Loaf Rises Then Falls "Cratered Loaf"	Loaf Rises Too High "Mushroom Loaf"	Loaf Does Not Rise Enough	Flat Loaf Little To No Rising	Crust Too Dark	Uncooked Or Partially Cooked	Not Mixed Or Partially Mixed	Gnarly Knotted Top	Loaf Core Texture Heavy & Dense	High Altitude Adjustment
POSSIBLE SOLUTIONS											
MEASUREMENT	FLOUR	↑									
		↓		2 Tbsp.					2 Tbsp.	2 Tbsp.	
	WATER OR MILK	↑			2 Tbsp.				2 Tbsp.		
		↓	2 Tbsp.	2 Tbsp.				2 Tbsp.			2 Tbsp.
	SALT	↑	1/4 tsp.	1/4 tsp.							
		↓			1/4 tsp.						
	SUGAR OR HONEY	↑			1 tsp.						1 tsp.
		↓		1 tsp.			1 tsp.				
	YEAST	↑			1/4 tsp.						1/4 tsp.
	↓	1/4 tsp.	1/4 tsp.								1/4 tsp.
INGREDIENT	WATER OR MILK	Not Enough Water Or Milk			✓			✓	✓		
		Liquid Too Hot Or Too Cold				See Page 17					
	FLOUR	Too Old			✓	✓					
		Low In Gluten Content			See Page 16	See Page 16					
		Too Fine	See Page 16		See Page 16			See Page 16			
	YEAST	None Was Added				✓					
		Out of Date Code				See Page 16					
		Used Fresh (Wrong Type)		See Pages 16 & 17	See Pages 16 & 17	See Pages 16 & 17				See Pages 16 & 17	
	SALT	Forgotten		✓							
		Too Much			✓	✓					

↑ Increase Amount

↓ Decrease Amount

How To Use Your Breadmaker



Slicing & Storing Bread

For best results, allow loaves to cool on a wire rack 15 to 30 minutes before slicing. You may use an electric knife (such as the Black & Decker Slice Right™ Electric Knife Model EK300) for even slices. Otherwise, use a sharp knife with a serrated blade. For sandwich slices, place the loaf on its side and slice across.

Store bread tightly covered (resealable style bags or plastic containers work well) at room temperature up to three days. If weather is hot and humid, store

in the refrigerator. For longer storage (up to one month), place bread in a tightly covered container in the freezer. If you store the bread in the refrigerator, leave it out to bring it to room temperature before serving. Since homemade bread has no preservatives, it tends to dry out and become stale faster than commercially-made bread.

Leftover slightly hardened bread may be cut into 1/2" or 1" cubes and used in favorite recipes to make croutons, bread pudding, or stuffing.

Care & Cleaning

CAUTION: To avoid electric shock, unplug the unit and allow the Breadmaker to cool before cleaning.

For best performance and maintenance, it is recommended to clean the breadmaker after each use as follows:

Outer Body and Oven Chamber:

Wipe the outer body of the unit with a damp cloth or slightly dampened sponge. Use a damp sponge or cloth to wipe out any flour, crumbs, or other materials from the oven chamber.

Lid

This unit has a removable Lid for easy cleaning. Open the Lid halfway and pull it out towards you. Wipe it with a damp cloth or slightly dampened sponge. **DO NOT IMMERSE THE LID** in liquid. Clean the viewing window with a moist soft cloth (not paper towel), then be sure to wipe it dry.

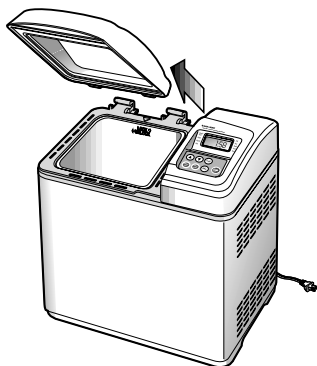

CAUTION: DO NOT clean window with a commercial glass cleaner!

When reinstalling the lid, be sure the slots on the lid are fully inserted into the posts on the hinge of the Breadmaker. This will prevent damage when closing the lid. If you feel resistance when you try to close the lid, stop immediately and reposition it. The lid should close easily without any force being applied.

Baking Pan and Mixing Paddle

Both the Baking Pan and Mixing Paddle have a non-stick coated surface. Do not use any harsh cleaners or utensils on these parts as scratching may occur. Over time, the non-stick surface may change in color due to moisture and steam. This is normal and has no effect on its use or quality.

Remove the Baking Pan and Mixing Paddle from the oven chamber before cleaning. Wipe the outside of the Baking Pan with a damp cloth. Be careful not to damage the rubber seal under the shaft. **NEVER TOTALLY IMMERSE THE BAKING PAN** in water. You can hand wash the inside of the Baking Pan with soapy water. The Mixing Paddle should be removed from the shaft and the depressed area under the Paddle cleaned. If the Mixing Paddle is hard to remove from the Baking Pan after baking, fill the Pan with hot water and let soak for 30 minutes to an hour. Next, pour out the water, turn the Pan over and wiggle the Paddle loose while holding the winged coupling on the bottom of the Pan. Using a toothpick or soft kitchen brush clean out any dough left in the hole of the Paddle.

CAUTION: None of the breadmaker parts are dishwasher-safe. **DO NOT** place the Baking Pan, Removable Lid, or Mixing Paddle in the dishwasher.

Storing The Unit

Be sure to dry all parts before storing and wipe any moisture from the Viewing Window. To prevent loss, you may want to store the Mixing Paddle on the shaft. Close the Lid and do not store anything on top of the Lid.

Care & Cleaning



Easy-Lift Grips

If you are storing the unit in a cabinet or closet, use the handy built in grips at the bottom of the unit to help you lift the breadmaker easily.

Service Or Repair

Service, if necessary, must be performed by a Black & Decker Household Appliance Company-Owned or Authorized Service Center. The Service Center nearest you can be found in the yellow pages of your phone book under "Appliances-Small-Repairing." For your convenience, a complete listing of U.S. and Canadian Company-Owned Service Centers and/or Authorized Service Centers is included on a handy insert.

If mailing or shipping your Breadmaker, pack it carefully in a sturdy carton with enough packing material to prevent damage. **Be sure to clean the unit before packing.** You may use original packaging as long as you've included packing material suitable for shipping. Include a note describing the problem to our Service Center and be sure to give your return address. We also suggest that you insure the package for your protection.

Consumer-replaceable parts and accessories are available at Black & Decker Household Appliance Company-Owned or Authorized Service Centers.

Full Two-Year Warranty

Black & Decker warrants this product against any defects that are due to faulty material or workmanship for a two-year period after the original date of consumer purchase or receipt as a gift. This warranty does not include damage to the product resulting from accident or misuse.

If the product should become defective within the warranty period, we will repair it or elect to replace it free of charge. We will return your product, transportation charges prepaid, provided it is delivered prepaid to any Black & Decker, Household Appliance Company-Owned or Authorized Service Center. This warranty gives you specific legal rights, and you may also have other rights which vary from state to state or province to province.

Answers to any questions regarding warranty or service locations may be obtained by calling or by writing:

In the U.S.A.

Consumer Assistance and Information
Black & Decker (U.S.) Inc.
6 Armstrong Road
Shelton, Connecticut 06484
1-800-231-9786

In Canada

Consumer Assistance and Information
Black & Decker Canada Inc.
100 Central Avenue
Brockville, Ontario K6V 5W6
1-800-465-6070
120 V, 60 Hz, AC Only, 600 watts

Listed by Underwriters Laboratories, Inc.
and Canadian Standards Association
Copyright ©1995 Black & Decker
Pub No. 168633-46
Printed in Hong Kong

 **BLACK & DECKER®**

Bread Recipes



**For Black & Decker Breadmakers
Model B1620**

Bread & Dough Ingredients



Many ingredients differ between Canada and the United States. Cheese, confectioner's (icing) sugar, and cornmeal are just a few ingredients that vary between the two countries. The major difference is in flour.

Flours

Canadian flours are milled from harder wheats so breads can be successfully made from national brands of both **All-Purpose Flour** and **Bread Flour**. U.S. "All-Purpose Flour" will produce poor results and should not be used with this unit. In the U.S., it is important to use "**Bread Flour**" for tall, even-textured loaves.

- **Bread flour** is processed from hard wheat and is high in the protein substance called gluten. When mixed and kneaded, the gluten stretches and incorporates air bubbles to produce a light, fine-textured loaf. The stretchy resilience of gluten makes this kind of flour most tolerant to high temperatures, altitude, or high humidity.
- **Canadian "All-Purpose Flour"** is easy to find and has been extensively tested with the Canadian recipes included in this book with good results. Canadian Bread Flour may also be used with good results.
- **Whole wheat and multi-grain flours** contain the bran and germ of the grain. Although higher in fiber, these flours are lower in gluten than bread flour. Rye flour does not contain any gluten and therefore, must be used in combination with other flours. Whole wheat, multi-grain and rye flour typically produce shorter, denser loaves. Whole wheat flours vary greatly between the United States and Canada. Be sure to consult the recipes for tips on successful whole wheat breads. The recipes have been developed and tested using nationally available brands of flour.

Fat

- **Butter, margarine or vegetable shortening** are often interchangeable in most bread recipes. Vegetable oil should not be substituted for shortening, butter or margarine (fat adds flavor and tenderness to the dough). **Low-fat (diet) margarines are high in water content but may be substituted with acceptable results for people on a low fat diet.**

Salt

- In very small amounts, **salt** adds flavor and controls the rising action of the yeast, allowing the dough to rise evenly. In high altitude areas, additional salt may be needed to improve bread results, however, keep in mind that too much salt may prevent the bread from rising.

Liquid

- **Milk**—whole, 1% or 2% fat, skim, buttermilk, or reconstituted (powdered) dry milk, and water are the most commonly used liquids in bread recipes. Milk provides a soft crust, and gives bread a velvety texture. If your recipe calls for powdered milk and you prefer to use fresh milk, simply substitute the milk for the water and powder. Water makes a crisper crust. Some recipes call for juice to be added as a flavor enhancer.

Sweeteners

- Natural sweeteners, such as white or brown sugar, honey, and molasses help the yeast in a recipe to grow. Sugar serves as food for the yeast. Without sugar, the yeast will not grow and the bread will not rise. The balance of sugar, salt, and yeast is a very important part of the bread making process. Sweeteners enhance the bread flavor and the browning process. If you prefer to use a sugar substitute, your baking results may vary with the type and amount of sugar substitute used.

Yeast

- **Yeast** is a heat-sensitive plant that feeds on the sugar in dough. Too much heat will kill the yeast, too little will slow the yeast action. Check the expiration date to be sure the yeast is fresh. The recipes in this cookbook have been tested with **Bread Machine** yeast. If you prefer to use Traditional Dry yeast, Rapid Rise yeast or Quick Rise yeast, you will have to **increase yeast amount by 1/4 teaspoon in your recipe**; for example - if your recipe called for 1 teaspoon of yeast, increase the amount to 1-1/4 teaspoon. See the test for yeast freshness on the next page.

Bread & Dough Ingredients



The following test can be used to determine whether your yeast is stale and inactive:

- A) Place 1/2 cup of lukewarm water into a small cup or bowl.
- B) Stir 1 tsp. of sugar into the water then sprinkle 2 tsp. of yeast over the surface.
- C) Place bowl or cup in a warm area and allow to sit for 10 minutes undisturbed.
- D) The mixture should foam and produce a strong yeast aroma. If this does not occur, fresh yeast should be purchased.

Tips For Getting The Best Results

- Use only fresh ingredients.
- In the U.S.: Use Bread Flour; In Canada: Use All-Purpose Flour or Canadian Bread Flour.
- Use lukewarm water – not cold water.
- Measure ingredients accurately and level off dry ingredients with the flat side of a knife or metal spatula. (See page 8 for measuring techniques).

Tips For Handling Dough

- When recipes call for a “lightly floured surface,” use about 1 to 2 tablespoons flour on the surface. You may want to lightly flour your fingers or rolling pin for easy dough manipulation.
- Recipes referring to a “greased/oiled” bowl call for about 1 tablespoon oil or soft vegetable shortening spread on the bottom and sides of the bowl. You may prefer to use a non-stick vegetable spray to “grease” the bowl to cut down on added fats and calories.
- When you let dough “rest” and “rise” according to a recipe, place it in a warm, draft-free area. For best results, cover the dough with waxed paper and a clean, dry towel. If the dough does not double in size, it may not produce a tender product.
- Dough may be wrapped in plastic and stored in a freezer for later use. Bring the dough to room temperature before using.

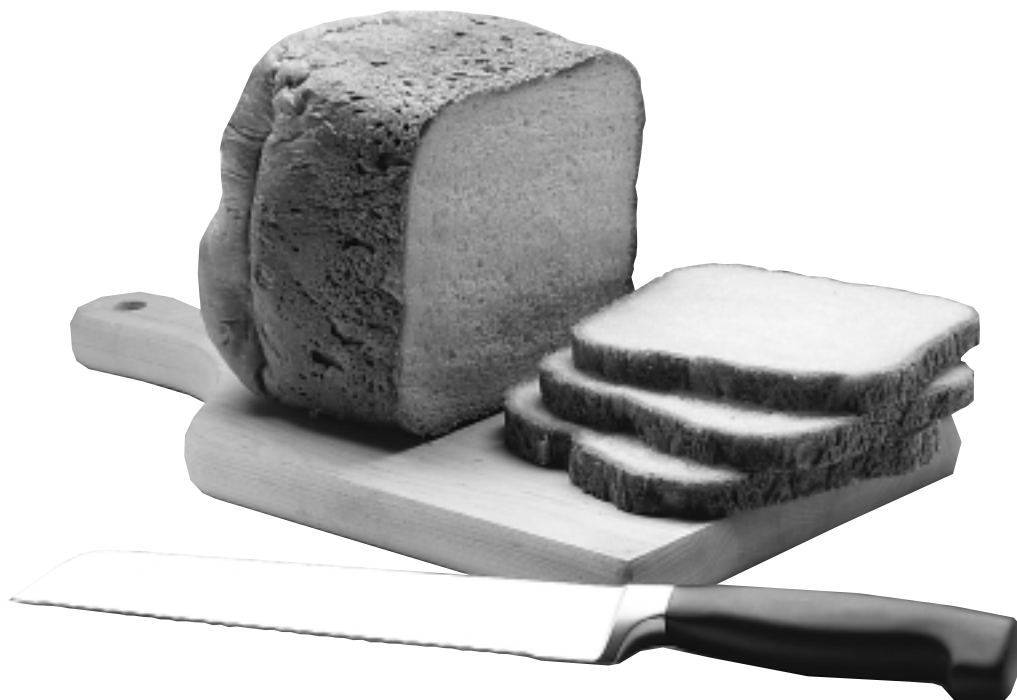

Recipe Index



The Basics

<i>Basic White (2.0 lb)</i>	19
<i>Basic White (1.5 lb)</i>	25
<i>100% Whole Wheat (2.0 lb)</i>	19
<i>100% Whole Wheat (1.5 lb)</i>	25
<i>Classic French (dough recipe) (2.0 lb)</i>	19
<i>Classic French (dough recipe) (1.5 lb)</i>	25
<i>Caraway Rye (2.0 lb)</i>	20
<i>Caraway Rye (1.5 lb)</i>	26

Rapid Bake Breads

<i>Rapid Basic White (2.0 lb)</i>	20
<i>Rapid Basic White (1.5 lb)</i>	26
<i>Rapid Lemon Poppy Seed (2.0 lb)</i>	21
<i>Rapid Lemon Poppy Seed (1.5 lb)</i>	27
<i>Rapid Italian Herb (2.0 lb)</i>	21
<i>Rapid Italian Herb (1.5 lb)</i>	27

Sandwich Pleasers For The Brown Bag Club

<i>Cornbread (2.0 lb)</i>	21
<i>Cornbread (1.5 lb)</i>	27
<i>Oatmeal Nut (2.0 lb)</i>	22
<i>Apple Cinnamon Granola (2.0 lb)</i>	22
<i>Cracked Wheat (2.0 lb)</i>	22
<i>Cracked Wheat (1.5 lb)</i>	27

Dinner Favorites

<i>Cheese 'N Onion (2.0 lb)</i>	23
<i>Cheese 'N Onion (1.5 lb)</i>	28
<i>Pizza Dough (dough recipe) (2.0 lb)</i>	23
<i>Pizza Dough (dough recipe) (1.5 lb)</i>	28

Treats For Every Age

<i>Cinnamon Raisin (2.0 lb)</i>	24
<i>Cinnamon Raisin (1.5 lb)</i>	29
<i>Raspberry Braid (dough recipe) (2.0 lb)</i>	24
<i>Raspberry Braid (dough recipe) (1.5 lb)</i>	29

Pasta Recipes

<i>Basic Pasta Dough (dough recipe)</i>	30
<i>Spinach Pasta Dough (dough recipe)</i>	30

The Basics (2.0 lb)



These are the recipes you will bake time after time. Try these recipes first.

BASIC WHITE

American		Canadian
1-1/3 cups	water	1-1/3 cups
2 tbsp.	powdered milk	2 tbsp.
1-1/2 tsp.	salt	1-1/2 tsp.
1 tbsp.	sugar	1 tbsp.
2 tbsp.	shortening	2 tbsp.
4 cups	white flour*	3-3/4 cups
1 tsp.	yeast	1 tsp.

1. Measure ingredients in the order listed into Baking Pan.
2. Insert Baking Pan into oven chamber, twist to secure. Close lid.
3. **Select: Basic Bread Setting.**
4. Select "Regular" or "Dark" crust.
5. Press Start - There will be a 15-minute preheat delay before mixing begins.
6. Using oven mitts, remove bread when completion beeps sound.
7. Cool on a wire rack before slicing.

Time: 3:50 hrs

100% WHOLE WHEAT

American		Canadian
1-1/2 cups	water	1-1/2 cups
2 tbsp.	powdered milk	2 tbsp.
1-1/2 tsp.	salt	1-1/2 tsp.
1 tbsp.	honey	2 tbsp.
1 tbsp.	molasses	2 tbsp.
2 tbsp.	shortening	2 tbsp.
3-1/2 cups	whole wheat flour	3-3/4 cups
1-1/4 tsp.	yeast	1-1/4 tsp.

1. Measure ingredients in the order listed into Baking Pan.
2. Insert Baking Pan into oven chamber, twist to secure. Close lid.
3. **Select: Whole Grain Setting.**
4. Crust setting is pre-selected.
5. Press Start - There will be a 25-minute preheat delay before mixing begins.
6. Using oven mitts, remove bread when completion beeps sound.
7. Cool on a wire rack before slicing.

Time: 4:10 hrs

▲ Helpful Tip

U.S. whole wheat flour results in a shorter, denser loaf than Canadian whole wheat flours. You can substitute one cup of white flour for one cup of whole wheat for a lighter, yet delicious wheat taste!

CLASSIC FRENCH

American	Dough Recipe	Canadian
1-1/4 cups	water	1-1/4 cups
1-1/4 tsp.	salt	1-1/4 tsp.
1 tbsp.	sugar	1 tbsp.
3-3/4 cups	white flour*	3-2/3 cups
1-1/2 tsp.	yeast	1-1/2 tsp.

GLAZE:

1 tbsp.	cornmeal (optional)	1 tbsp.
1 tbsp.	oil	1 tbsp.
1	egg white, beaten	1
1 tbsp.	water	1 tbsp.

1. Measure first 5 ingredients in the order listed into Baking Pan.
2. Insert Baking Pan into oven chamber, twist to secure. Close lid.
3. **Select: Dough/Pasta Setting.**
4. Press Start - There will be a 25-minute preheat delay before mixing begins.
5. When cycle is complete, remove dough from machine to a lightly floured surface. If necessary, knead in enough flour to make dough easy to handle.
6. Divide dough in half and roll each half into a 10" x 8" rectangle. Beginning at long end, roll up tightly as for jelly roll. Pinch seams and ends to seal. Taper ends by gently rolling back and forth.
7. Place each loaf, seam side down, on a greased baking sheet sprinkled with cornmeal (optional). Lightly brush each loaf with oil. Cover and let rise in warm, draft-free place for 20 to 30 minutes until double in size. With a sharp knife make 3 or 4 diagonal cuts about 1/4 inch deep across the top of each loaf. Lightly beat egg white and 1 tablespoon water; brush some of egg white mixture over top of each loaf. Bake at 350°F for 20 minutes. Brush again with remaining egg white mixture.
8. Bake 5 to 10 minutes more or until done. Bread should sound hollow when tapped. (For even browning when baking two loaves, switch positions of sheets halfway through baking.) Remove the breads from the sheets; cool on a wire rack.
Yield: Makes 2 loaves.

▲ Helpful Tip

This crusty french bread, with its chewy texture makes a delicious garlic bread. Just slice lengthwise, top with garlic butter & broil.

* In U.S., use Bread Flour; in Canada, use either Bread Flour or All-Purpose Flour.

The Basics (2.0 lb)



CARAWAY RYE

American		Canadian
1-1/4 cups	water	1-1/4 cups
2 tbsp.	powdered milk	2 tbsp.
1-1/4 tsp.	salt	1-1/2 tsp.
1 tbsp.	brown sugar	2 tbsp.
1 tbsp.	molasses	2 tbsp.
2 tbsp.	shortening	2 tbsp.
2/3 cup	whole wheat flour	3/4 cup
1-3/4 cups	white flour*	1-3/4 cups
3/4 cup	rye flour	3/4 cup
1 tbsp.	caraway seeds	1 tbsp.
1-1/2 tsp.	yeast	1-1/4 tsp.

1. Measure ingredients in the order listed into Baking Pan.
2. Insert Baking Pan into oven chamber, twist to secure. Close lid.
3. **Select: Whole Grain Setting.**
4. Crust setting is pre-selected.
5. Press Start - There will be a 25-minute preheat delay before mixing begins.
6. Using oven mitts, remove bread when completion beeps sound.
7. Cool on a wire rack before slicing.

Time: 4:10 hrs



Rapid Bake Breads (2.0 lb)



All the breads in this section will take only 1 hour & 58 minutes to complete.

RAPID BASIC WHITE

American		Canadian
1-2/3 cups	water	1-1/4 cups
2 tbsp.	powdered milk	3 tbsp.
1 tsp.	salt	1 tsp.
3 tbsp.	sugar	3 tbsp.
2 tbsp.	shortening	3 tbsp.
4-1/4 cups	white flour*	3-1/4 cups
2 tsp.	yeast	2 tsp.

1. Measure ingredients in the order listed into Baking Pan.
2. Insert Baking Pan into oven chamber, twist to secure. Close lid.
3. **Select: Rapid Bake Setting.**
4. Select "Regular" or "Dark" crust.
5. Press Start - There will be a 5-minute preheat delay before mixing begins.
6. Using oven mitts, remove bread when completion beeps sound.
7. Cool on a wire rack before slicing.



* In U.S., use Bread Flour; in Canada, use either Bread Flour or All-Purpose Flour.

Rapid Bake Breads (2.0 lb)



RAPID LEMON POPPY SEED

American		Canadian
1-1/4 cups	water	1-1/4 cups
1-1/2 tsp.	lemon juice, freshly squeezed	1-1/2 tsp.
2 tbsp.	powdered milk	2 tbsp.
1-1/4 tsp.	salt	1-1/4 tsp.
2 tbsp.	sugar	2 tbsp.
2 tbsp.	shortening	2 tbsp.
3-1/4 cups	white flour*	3 cups
1/2 tsp.	nutmeg	1/2 tsp.
2 tsp.	lemon rind, freshly grated	2 tsp.
2 tbsp.	poppy seeds	2 tbsp.
2 tsp.	yeast	2 tsp.

1. Measure ingredients in the order listed into Baking Pan.
2. Insert Baking Pan into oven chamber, twist to secure. Close lid.
3. **Select: Rapid Bake Setting.**
4. Select "Regular" or "Dark" crust.
5. Press Start - There will be a 5-minute preheat delay before mixing begins.
6. Using oven mitts, remove bread when completion beeps sound.
7. Cool on a wire rack before slicing.

RAPID ITALIAN HERB

American		Canadian
1-1/3 cups	water	1-1/3 cups
3 tbsp.	powdered milk	3 tbsp.
1-1/2 tsp.	salt	1-1/2 tsp.
3 tbsp.	sugar	3 tbsp.
3 tbsp.	shortening	3 tbsp.
3-3/4 cups	white flour*	3-2/3 cups
1-1/2 tsp.	dried marjoram	1-1/2 tsp.
1-1/2 tsp.	dried basil	1-1/2 tsp.
1-1/2 tsp.	dried thyme	1-1/2 tsp.
2 tsp.	yeast	2 tsp.

1. Measure ingredients in the order listed into Baking Pan.
2. Insert Baking Pan into oven chamber, twist to secure. Close lid.
3. **Select: Rapid Bake Setting.**
4. Select "Regular" or "Dark" crust.
5. Press Start - There will be a 5-minute preheat delay before mixing begins.
6. Using oven mitts, remove bread when completion beeps sound.
7. Cool on a wire rack before slicing.



Sandwich Pleasers For The Brown Bag Club (2.0 lb)

This selection of recipes will have you looking forward to noon!

CORNBREAD

American		Canadian
1-1/3 cups	1 egg+water to =	1-1/2 cups
2 tbsp.	powdered milk	2 tbsp.
2 tsp.	salt	2 tsp.
2 tbsp.	honey	2 tbsp.
2 tbsp.	shortening	2 tbsp.
3-1/2 cups	white flour*	3-1/2 cups
1/2 cup	cornmeal	1/2 cup
1 tsp.	yeast	1 tsp.

1. Measure ingredients in the order listed into Baking Pan.
2. Insert Baking Pan into oven chamber, twist to secure. Close lid.
3. **Select: Basic Bread Setting.**
4. Select "Regular" or "Dark" crust.
5. Press Start - There will be a 15-minute preheat delay before mixing begins.
6. Using oven mitts, remove bread when completion beeps sound.
7. Cool on a wire rack before slicing.

Time: 3:50 hrs

* In U.S., use Bread Flour; in Canada, use either Bread Flour or All-Purpose Flour.

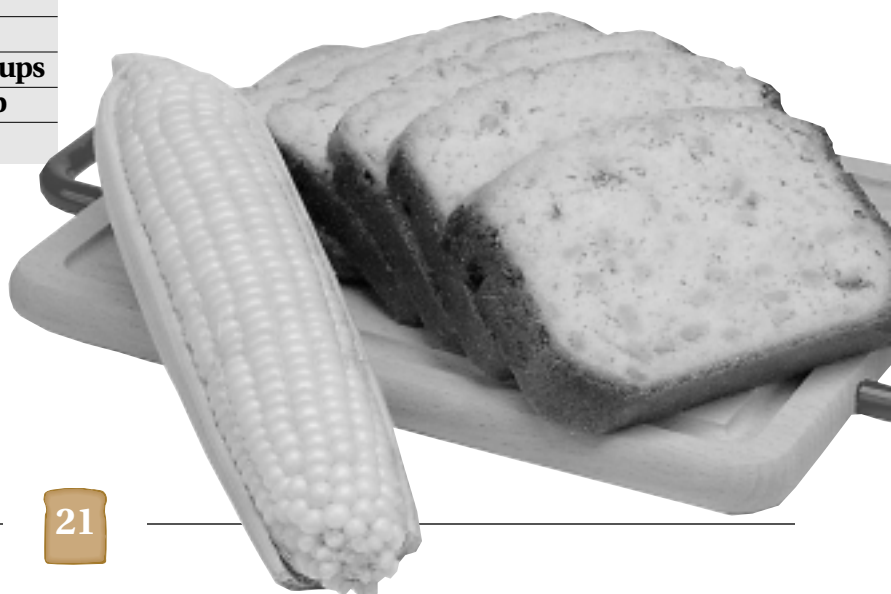

Sandwich Pleasers For The Brown Bag Club (2.0 lb)



OATMEAL NUT

American		Canadian
1-1/4 cups	water	1-1/4 cups
2 tbsp.	powdered milk	2 tbsp.
1-1/4 tsp.	salt	1-1/4 tsp.
1 tbsp.	molasses	1 tbsp.
1tbsp.	honey	1 tbsp.
2 tbsp.	shortening	2 tbsp.
3/4 cup	whole wheat flour	1 cup
2 cups	white flour*	1-3/4 cups
1/3 cup	oatmeal, quick cooking	1/3 cup
1-1/4 tsp.	yeast	1-1/4 tsp.

ADD INGREDIENTS:

1/3 cup walnuts, chopped 1/3 cup

1. Measure first 10 ingredients in the order listed into Baking Pan.
2. Insert Baking Pan into oven chamber; twist to secure. Close lid.
3. **Select: Whole Grain Setting.**
4. Crust setting is pre-selected.
5. Press Start - There will be a 25-minute preheat delay before mixing begins.
6. Add walnuts when "Add Ingredient" signal beeps.
7. Using oven mitts, remove bread when completion beeps sound.
8. Cool on a wire rack before slicing.

Time: 4:10 hrs

▲ Helpful Tip

Small flake rolled oats gives a traditional oatmeal bread texture. Do not use "instant cooking" oatmeal.

APPLE CINNAMON GRANOLA

American		Canadian
2/3 cup	apple juice, unsweetened	2/3 cup
2/3 cup	applesauce, unsweetened	2/3 cup
1 tsp.	salt	1 tsp.
2 tbsp.	honey	2 tbsp.
2 tbsp.	shortening	2 tbsp.
1 cup	whole wheat flour	1 cup
1-3/4 cups	white flour*	2 cups
1/3 cup	granola	1/3 cup
1/2 tsp.	cinnamon	1/2 tsp.
1-1/2 tsp.	yeast	1-1/2 tsp.

ADD INGREDIENTS:

1/3 cup raisins 1/3 cup

* In U.S., use Bread Flour; in Canada, use either Bread Flour or All-Purpose Flour.

CRACKED WHEAT

American		Canadian
1-1/2 cups	water	1-1/3 cups
2 tbsp.	powdered milk	3 tbsp.
1-1/2 tsp.	salt	1-1/2 tsp.
2 tbsp.	honey	3 tbsp.
2 tbsp.	shortening	3 tbsp.
1 cup	whole wheat flour	1-1/4 cups
2-1/4 cups	white flour*	1-1/2 cups
3/4 cup	cracked wheat	1 cup
1-1/4 tsp.	yeast	1-1/4 tsp.

1. Measure ingredients in the order listed into Baking Pan.
2. Insert Baking Pan into oven chamber; twist to secure. Close lid.
3. **Select: Whole Grain Setting.**
4. Crust setting is pre-selected.
5. Press Start - There will be a 25-minute preheat delay before mixing begins.
6. Using oven mitts, remove bread when completion beeps sound.
7. Cool on a wire rack before slicing.

Time: 4:10 hrs

▲ Helpful Tip

The crunchy texture & slightly nutty flavor of this bread makes it a treat with luncheon meats. Look for bulgar or cracked wheat in large grocery stores, bulk & health food stores.

1. Measure first 10 ingredients in the order listed into Baking Pan.
2. Insert Baking Pan into oven chamber; twist to secure. Close lid.
3. **Select: Sweet Setting.**
4. Select "Regular" or "Dark" crust.
5. Press Start - There will be a 15-minute preheat delay before mixing begins.
6. Add raisins when "Add Ingredient" signal beeps.
7. Using oven mitts, remove bread when completion beeps sound.
8. Cool on a wire rack before slicing.

Time: 3:50 hrs

◀ Helpful Tip

Try on the Whole Grain cycle for a darker crust. Try different flavors of granola for a variety of tastes.

Dinner Favorites (2.0 lb)



These selections will add zest to any casserole or entrée.

CHEESE 'N ONION

American		Canadian
1-1/3 cups	water	1-1/3 cups
3 tbsp.	powdered milk	3 tbsp.
1-1/2 tsp.	salt	1-1/2 tsp.
2 tbsp.	sugar	2 tbsp.
3-2/3 cups	white flour*	3-1/2 cups
2 tbsp.	dried onion flakes	2 tbsp.
1/3 cup	shredded old cheddar cheese	1/3 cup
1-1/4 tsp.	yeast	1-1/4 tsp.

1. Measure ingredients in the order listed into Baking Pan.
2. Insert Baking Pan into oven chamber, twist to secure. Close lid.
3. **Select: Sweet Bread Setting.**
4. Select "Regular" or "Dark" crust.
5. Press Start - There will be a 15-minute preheat delay before mixing begins.
6. Using oven mitts, remove bread when completion beeps sound.
7. Cool on a wire rack before slicing.

Time: 3:50 hrs

▲ Helpful Tip

1/4 cup chopped fresh onion can be substituted for the dried onion flakes for a milder onion flavour.

Purchase 1-1/2 oz or 35 g of a good quality, sharp flavoured Old Cheddar Cheese for a strong cheese flavour.

Dough Variation: Prepare this recipe using the dough/pasta setting Form into 6 hamburger buns following the instructions under the Dinner Rolls recipe, & enjoy at your barbecue.

PIZZA DOUGH

American	Dough Recipe	Canadian
1-1/2 cups	beer	1-1/2 cups
1-1/2 tsp.	salt	1-1/2 tsp.
1 tbsp.	sugar	1 tbsp.
2 tbsp.	shortening	2 tbsp.
4-1/2 cups	white flour*	4-1/4 cups
2 tsp.	yeast	2 tsp.

OPTIONAL INGREDIENT:

3 tbsp.	cornmeal	3 tbsp.
---------	----------	---------

1. Measure first 6 ingredients in order listed into Baking Pan.
2. Insert Baking Pan into oven chamber, twist to secure. Close lid.
3. **Select: Dough/Pasta Setting.**
4. Press Start - There will be a 25-minute preheat delay before mixing begins.
5. When cycle is complete, remove dough from machine to a lightly floured surface. If necessary, knead in enough flour to make dough easy to handle.
6. Grease 3 12-inch pans & sprinkle with cornmeal (optional). Divide dough into three. Roll out dough and place on pan or pat in pan.
7. Top each pizza with tomato sauce, meat, vegetables and cheese. Bake at 425°F for 15 to 25 minutes or until done. Pizza is done when edges of crust are golden and cheese is bubbly.
Yield: Makes 3 pizzas.

▲ Helpful Tip

Water can be substituted for beer in the recipe. Add 1/2 - 1 tsp. basil or oregano to the ingredients in the Baking Pan for a spicier crust.

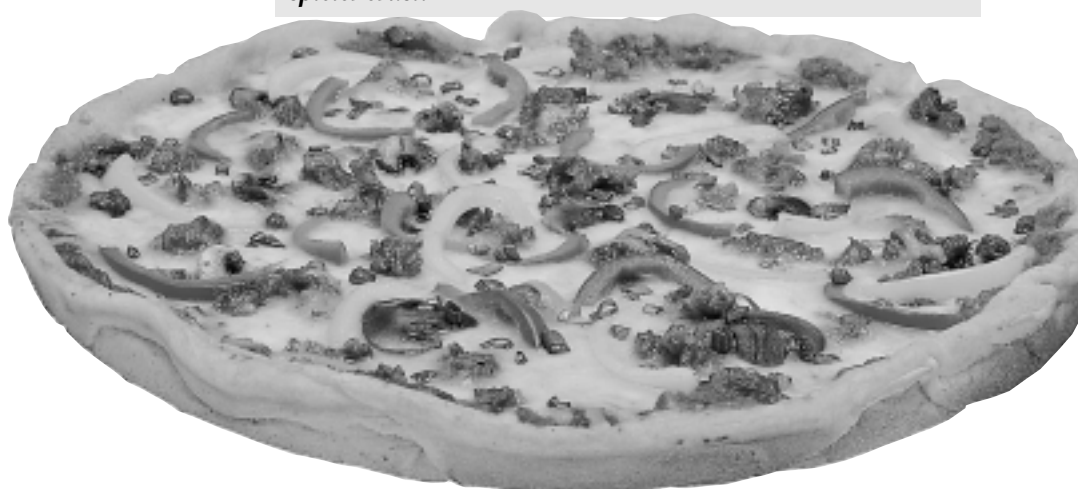

* In U.S., use Bread Flour; in Canada, use either Bread Flour or All-Purpose Flour.

Treats For Every Age (2.0 lb)



Enjoy these recipes for a change of pace!

CINNAMON RAISIN

American		Canadian
1-1/4 cups	1 egg + water to =	1-1/4 cups
2 tbsp.	powdered milk	2 tbsp.
1-1/4 tsp.	salt	1-1/4 tsp.
2 tbsp.	brown sugar	2 tbsp.
2 tbsp.	butter	2 tbsp.
3-2/3 cups	white flour*	3-3/4 cups
1 tsp.	cinnamon	1 tsp.
1-1/4 tsp.	yeast	1-1/4 tsp.

ADD INGREDIENTS:		
1/2 cup	raisins	1/2 cup

1. Measure first 8 ingredients in the order listed into Baking Pan.
2. Insert Baking Pan into oven chamber, twist to secure. Close lid.
3. **Select: Sweet Bread Setting.**
4. Select "Regular" or "Dark" crust.
5. Press Start - There will be a 15-minute preheat delay before mixing begins.
6. Add raisins when "Add Ingredient" signal beeps.
7. Using oven mitts, remove bread when completion beeps sound.
8. Cool on a wire rack before slicing.

Time: 3:50 hrs



RASPBERRY BRAID

American	Dough Recipe	Canadian
1-1/4 cups	milk	1-1/4 cups
1	egg, beaten	1
3/4 tsp.	salt	3/4 tsp.
1/4 cup	sugar	1/4 cup
2 tbsp.	butter	2 tbsp.
3-3/4 cups	white flour*	3-2/3 cups
1-1/4 tsp.	yeast	1-1/4 tsp.

FILLING:		
1/2 cup	raspberry jam	1/2 cup
2 tbsp.	butter, melted - cooled	2 tbsp.

TOPPING:		
2 tbsp.	butter, soft	2 tbsp.
2 tbsp.	brown sugar	2 tbsp.
1/4 cup	white flour*	1/4 cup
1/2 tsp.	nutmeg	1/2 tsp.

1. Measure first 7 ingredients in the order listed into Baking Pan.
2. Insert Baking Pan into oven chamber, twist to secure. Close lid.
3. **Select: Dough/Pasta Setting.**
4. Press Start - There will be a 25-minute preheat delay before mixing begins.
5. When cycle is complete, remove dough from machine to a lightly floured surface. Divide dough in half. Roll each half into a 14" x 9" rectangle. Spread with 1/4 cup raspberry jam lengthwise down center third of rectangle. Make diagonal cuts from outer edges one inch apart and three inches long. Fold alternate strips of dough over filling. Place on greased baking sheet. Brush with melted, cooled butter. Cover & let rise 30 minutes or until double in volume. Sprinkle half of butter, sugar and flour mixture over each dough braid. (see diagram below)
6. Bake at 350°F for 30-35 minutes. Yield: Makes 2 braids.

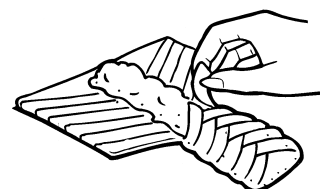
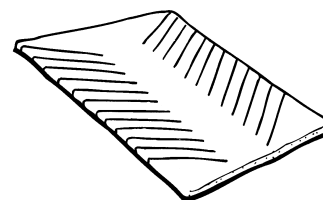

* In U.S., use Bread Flour; in Canada, use either Bread Flour or All-Purpose Flour.

The Basics (1.5 lb)

These are the recipes you will bake time after time. Try these recipes first.

BASIC WHITE

American		Canadian
1-1/4 cups	water	1-1/4 cups
1 tbsp.	powdered milk	1 tbsp.
1 tsp.	salt	1 tsp.
1 tbsp.	sugar	1 tbsp.
2 tbsp.	shortening	2 tbsp.
3-1/3 cups	white flour*	3-1/4 cups
3/4 tsp.	yeast	3/4 tsp.

1. Measure ingredients in the order listed into Baking Pan.
2. Insert Baking Pan into oven chamber, twist to secure. Close lid.
3. **Select: Basic Bread Setting.**
4. Select "Regular" or "Dark" crust.
5. Press Start - There will be a 15-minute preheat delay before mixing begins.
6. Using oven mitts, remove bread when completion beeps sound.
7. Cool on a wire rack before slicing.

Time: 3:50 hrs

100% WHOLE WHEAT

American		Canadian
1-1/3 cups	water	1-1/4 cups
2 tbsp.	powdered milk	2 tbsp.
1-1/2 tsp.	salt	1 tsp.
2 tsp.	honey	1 tbsp.
2 tsp.	molasses	1tbsp.
2 tbsp.	shortening	2 tbsp.
3-1/4 cups	whole wheat flour	3-1/4 cups
1-1/4 tsp.	yeast	1-1/4 tsp.

1. Measure ingredients in the order listed into Baking Pan.
2. Insert Baking Pan into oven chamber, twist to secure. Close lid.
3. **Select: Whole Grain Setting.**
4. Crust setting is pre-selected.
5. Press Start - There will be a 25-minute preheat delay before mixing begins.
6. Using oven mitts, remove bread when completion beeps sound.
7. Cool on a wire rack before slicing.

Time: 4:10 hrs

▲ Helpful Tip

U.S. whole wheat flour results in a shorter, denser loaf than Canadian whole wheat flours. You can substitute one cup of white flour for one cup of whole wheat for a lighter, yet delicious wheat taste!

CLASSIC FRENCH

American	Dough Recipe	Canadian
1-1/4 cups	water	1-1/4 cups
1 tsp.	salt	1 tsp.
2 tsp.	sugar	2 tsp.
3-1/2 cups	white flour*	3-1/3 cups
1-1/4 tsp.	yeast	1-1/4 tsp.

GLAZE:

1 tbsp.	cornmeal (optional)	1 tbsp.
1 tbsp.	oil	1 tbsp.
1	egg white, beaten	1
1 tbsp.	water	1 tbsp.

1. Measure first 5 ingredients in the order listed into Baking Pan.
2. Insert Baking Pan into oven chamber, twist to secure. Close lid.
3. **Select: Dough/Pasta Setting.**
4. Press Start - There will be a 25-minute preheat delay before mixing begins.
5. When cycle is complete, remove dough from machine to a lightly floured surface. If necessary, knead in enough flour to make dough easy to handle.
6. Roll into a 10" x 8" inch rectangle. Beginning at long end, roll up tightly as for jelly roll. Pinch seams and ends to seal. Taper ends by gently rolling back and forth.
7. Place loaf, seam side down, on a greased baking sheet sprinkled with cornmeal (optional). Lightly brush loaf with oil. Cover and let rise in warm, draft-free place for 20 to 30 minutes until double in size. With a sharp knife make 3 or 4 diagonal cuts about 1/4 inch deep across the top of loaf. Lightly beat egg white and 1 tablespoon water; brush some of egg white mixture over top of loaf. Bake at 350°F for 20 minutes. Brush again with remaining egg white mixture.
8. Bake 5 to 10 minutes more or until done. Bread should sound hollow when tapped. Remove the bread from the sheet; cool on a wire rack.

Yield: Makes 1 large loaf.

▲ Helpful Tip

This crusty french bread, with its chewy texture makes a delicious garlic bread. Just slice lengthwise, top with garlic butter & broil.

* In U.S., use Bread Flour; in Canada, use either Bread Flour or All-Purpose Flour.

The Basics (1.5 lb)



CARAWAY RYE

American		Canadian
1 cup	water	1 cup
2 tbsp.	powdered milk	2 tbsp.
1-1/4 tsp.	salt	1-1/2 tsp.
2 tsp.	brown sugar	1 tbsp.
2 tsp.	molasses	1 tbsp.
2 tbsp.	shortening	2 tbsp.
3/4 cup	whole wheat flour	3/4 cup
1-2/3 cups	white flour*	1-1/2 cups
1/2 cup	rye flour	1/2 cup
2 tsp.	caraway seeds	2 tsp.
1-1/4 tsp.	yeast	1-1/4 tsp.

1. Measure ingredients in the order listed into Baking Pan.
2. Insert Baking Pan into oven chamber, twist to secure. Close lid.
3. **Select: Whole Grain Setting.**
4. Crust setting is pre-selected.
5. Press Start - There will be a 25-minute preheat delay before mixing begins.
6. Using oven mitts, remove bread when completion beeps sound.
7. Cool on a wire rack before slicing.

Time: 4:10 hrs



Rapid Bake Breads (1.5 lb)



All the breads in this section will take only 1 hour & 58 minutes to complete.

RAPID BASIC WHITE

American		Canadian
1-1/3 cups	water	1 cup
2 tbsp.	powdered milk	2 tbsp.
1-1/4 tsp.	salt	3/4 tsp.
2 tbsp.	sugar	2 tbsp.
2 tbsp.	shortening	2 tbsp.
3-1/3 cups	white flour*	2-2/3 cups
2 tsp.	yeast	2 tsp.

1. Measure ingredients in the order listed into Baking Pan.
2. Insert Baking Pan into oven chamber, twist to secure. Close lid.
3. **Select: Rapid Bake Setting.**
4. Select "Regular" or "Dark" crust.
5. Press Start - There will be a 5-minute preheat delay before mixing begins.
6. Using oven mitts, remove bread when completion beeps sound.
7. Cool on a wire rack before slicing.



* In U.S., use Bread Flour; in Canada, use either Bread Flour or All-Purpose Flour.

Rapid Bake Breads (1.5 lb)



RAPID LEMON POPPY SEED

American		Canadian
1 cup	water	1 cup
1 tsp.	lemon juice, freshly squeezed	1 tsp.
2 tbsp.	powdered milk	2 tbsp.
1 tsp.	salt	1 tsp.
2 tbsp.	sugar	2 tbsp.
2 tbsp.	shortening	2 tbsp.
2-3/4 cups	white flour*	2-2/3 cups
1/4 tsp.	nutmeg	1/4 tsp.
1 tsp.	lemon rind, freshly grated	1 tsp.
1 tbsp.	poppy seeds	1 tbsp.
2 tsp.	yeast	2 tsp.

1. Measure ingredients in the order listed into Baking Pan.
2. Insert Baking Pan into oven chamber, twist to secure. Close lid.
3. **Select: Rapid Bake Setting.**
4. Select "Regular" or "Dark" crust.
5. Press Start - There will be a 5-minute preheat delay before mixing begins.
6. Using oven mitts, remove bread when completion beeps sound.
7. Cool on a wire rack before slicing.

RAPID ITALIAN HERB

American		Canadian
1-1/4 cups	water	1-1/4 cups
2 tbsp.	powdered milk	2 tbsp.
1 tsp.	salt	1 tsp.
2 tbsp.	sugar	2 tbsp.
3 tbsp.	shortening	3 tbsp.
3-1/3 cups	white flour*	3-1/4 cups
1 tsp.	dried marjoram	1 tsp.
1 tsp.	dried basil	1 tsp.
1 tsp.	dried thyme	1 tsp.
2 tsp.	yeast	2 tsp.

1. Measure ingredients in the order listed into Baking Pan.
2. Insert Baking Pan into oven chamber, twist to secure. Close lid.
3. **Select: Rapid Bake Setting.**
4. Select "Regular" or "Dark" crust.
5. Press Start - There will be a 5-minute preheat delay before mixing begins.
6. Using oven mitts, remove bread when completion beeps sound.
7. Cool on a wire rack before slicing.

Sandwich Pleasers For The Brown Bag Club (1.5 lb)



This selection of recipes will have you looking forward to noon!

CORNBREAD

American		Canadian
1-1/4 cups	1 egg+water to =	1-1/4 cups
2 tbsp.	powdered milk	2 tbsp.
1-1/2 tsp.	salt	1-1/2 tsp.
1 tbsp.	honey	1 tbsp.
1 tbsp.	shortening	1 tbsp.
3 cups	white flour*	2-3/4 cups
1/3 cup	cornmeal	1/3 cup
1 tsp.	yeast	1 tsp.

1. Measure ingredients in the order listed into Baking Pan.
2. Insert Baking Pan into oven chamber, twist to secure. Close lid.
3. **Select: Basic Bread Setting.**
4. Select "Regular" or "Dark" crust.
5. Press Start - There will be a 15-minute preheat delay before mixing begins.
6. Using oven mitts, remove bread when completion beeps sound.
7. Cool on a wire rack before slicing.

Time: 3:50 hrs

CRACKED WHEAT

American		Canadian
1-1/4 cups	water	1-1/4 cups
2 tbsp.	powdered milk	2 tbsp.
1-1/4 tsp.	salt	1-1/4 tsp.
2 tbsp.	honey	2 tbsp.
2 tbsp.	shortening	2 tbsp.
3/4 cup	whole wheat flour	1 cup
2 cups	white flour*	1-1/2 cups
3/4 cup	cracked wheat	3/4 cup
1-1/2 tsp.	yeast	1-1/4 tsp.

1. Measure ingredients in the order listed into Baking Pan.
2. Insert Baking Pan into oven chamber, twist to secure. Close lid.
3. **Select: Whole Grain Setting.**
4. Crust setting is pre-selected.
5. Press Start - There will be a 25-minute preheat delay before mixing begins.
6. Using oven mitts, remove bread when completion beeps sound.
7. Cool on a wire rack before slicing.

Time: 4:10 hrs

* In U.S., use Bread Flour; in Canada, use either Bread Flour or All-Purpose Flour.

Dinner Favorites (1.5 lb)



These selections will add zest to any casserole or entrée.

CHEESE 'N ONION

American		Canadian
1-1/4 cups	water	1-1/4 cups
2 tbsp.	powdered milk	2 tbsp.
1 tsp.	salt	1 tsp.
1 tbsp.	sugar	1 tbsp.
3-1/3 cups	white flour*	3-1/4 cups
1 tbsp.	dried onion flakes	1 tbsp.
1/4 cup	shredded old cheddar cheese	1/4 cup
1 tsp.	yeast	1 tsp.

1. Measure ingredients in the order listed into Baking Pan.
2. Insert Baking Pan into oven chamber; twist to secure. Close lid.
3. **Select: Sweet Bread Setting.**
4. Select "Regular" or "Dark" crust.
5. Press Start - There will be a 15-minute preheat delay before mixing begins.
6. Using oven mitts, remove bread when completion beeps sound.
7. Cool on a wire rack before slicing.

Time: 3:50 hrs

▲ Helpful Tip

3 tablespoons chopped fresh onion can be substituted for the dried onion flakes for a milder onion flavour.

Purchase 1 oz or 25 g of a good quality, sharp flavoured Old Cheddar Cheese for a strong cheese flavour.

Dough Variation: Prepare this recipe using the dough/pasta setting Form into 6 hamburger buns following the instructions under the Dinner Rolls recipe, & enjoy at your barbecue.

PIZZA DOUGH

American	Dough Recipe	Canadian
1 cup	beer	1 cup
1 tsp.	salt	1 tsp.
1 tbsp.	sugar	1 tbsp.
1 tbsp.	shortening	1 tbsp.
3 cups	white flour*	2-3/4 cups
1-1/4 tsp.	yeast	1-1/4 tsp.

OPTIONAL INGREDIENT:

2 tbsp.	cornmeal	2 tbsp.
---------	----------	---------

1. Measure first 6 ingredients in order listed into Baking Pan.
2. Insert Baking Pan into oven chamber; twist to secure. Close lid.
3. **Select: Dough/Pasta Setting.**
4. Press Start - There will be a 25-minute preheat delay before mixing begins.
5. When cycle is complete, remove dough from machine to a lightly floured surface. If necessary, knead in enough flour to make dough easy to handle.
6. Grease 2 12-inch pans & sprinkle with cornmeal (optional). Divide dough in half. Roll out dough and place on pan or pat in pan.
7. Top each pizza with tomato sauce, meat, vegetables and cheese. Bake at 425°F for 15 to 25 minutes or until done. Pizza is done when edges of crust are golden and cheese is bubbly.
Yield: Makes 2 pizzas.

▲ Helpful Tip

Water can be substituted for beer in the recipe. Add 1/2 - 1 tsp. basil or oregano to the ingredients in the Baking Pan for a spicier crust.



* In U.S., use Bread Flour; in Canada, use either Bread Flour or All-Purpose Flour.

Treats For Every Age (1.5 lb)



Enjoy these recipes for a change of pace!

CINNAMON RAISIN

American		Canadian
1 cup	1 egg + water to =	1 cup
1 tbsp.	powdered milk	1 tbsp.
1-1/4 tsp.	salt	1-1/4 tsp.
2 tbsp.	brown sugar	2 tbsp.
2 tbsp.	butter	2 tbsp.
2-2/3 cups	white flour*	2-1/2 cups
1/2 tsp.	cinnamon	1/2 tsp.
1 tsp.	yeast	1 tsp.

ADD INGREDIENTS:

1/3 cup	raisins	1/3 cup
---------	---------	---------

1. Measure first 8 ingredients in the order listed into Baking Pan.
2. Insert Baking Pan into oven chamber, twist to secure. Close lid.
3. **Select: Sweet Bread Setting.**
4. Select "Regular" or "Dark" crust.
5. Press Start - There will be a 15-minute preheat delay before mixing begins.
6. Add raisins when "Add Ingredient" signal beeps.
7. Using oven mitts, remove bread when completion beeps sound.
8. Cool on a wire rack before slicing.

Time: 3:50 hrs

RASPBERRY BRAID

American	Dough Recipe	Canadian
1 cup	milk	1 cup
1	egg, beaten	1
3/4 tsp.	salt	3/4 tsp.
3 tbsp.	sugar	3 tbsp.
2 tbsp.	butter	2 tbsp.
3-1/3 cups	white flour*	3-1/4 cups
3/4 tsp.	yeast	3/4 tsp.

FILLING:

1/4 cup	raspberry jam	1/4 cup
2 tbsp.	butter, melted - cooled	2 tbsp.

TOPPING:

1 tbsp.	butter, soft	1 tbsp.
1 tbsp.	brown sugar	1 tbsp.
2 tbsp.	white flour*	2 tbsp.
1/4 tsp.	nutmeg	1/4 tsp.

1. Measure first 7 ingredients in the order listed into Baking Pan.
2. Insert Baking Pan into oven chamber, twist to secure. Close lid.
3. **Select: Dough/Pasta Setting.**
4. Press Start - There will be a 25-minute preheat delay before mixing begins.
5. When cycle is complete, remove dough from machine to a lightly floured surface. Divide dough in half. Roll each half into a 14" x 9" rectangle. Spread with 1/4 cup raspberry jam lengthwise down center third of rectangle. Make diagonal cuts from outer edges one inch apart and three inches long. Fold alternate strips of dough over filling. Place on greased baking sheet. Brush with melted, cooled butter. Cover & let rise 30 minutes or until double in volume. Sprinkle half of butter, sugar and flour mixture over each dough braid. (see diagram below)
6. Bake at 350°F for 30-35 minutes. Yield: Makes 2 braids.

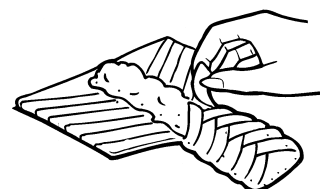
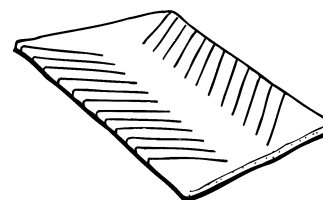
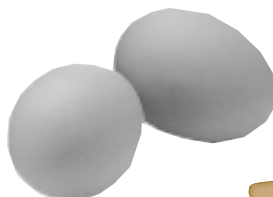

* In U.S., use Bread Flour; in Canada, use either Bread Flour or All-Purpose Flour.

Pasta Recipes



For the do-it-yourself Pasta Lover.

BASIC PASTA DOUGH

American	Dough Recipe	Canadian
1/2 cup	water	1/2 cup
1	egg, beaten	1
2 tbsp.	olive oil	2 tbsp.
1/2 tsp.	salt	1/2 tsp.
2-3/4 cups	semolina/pasta flour	2-1/2 cups

- Mix water and egg with a fork.
- Add water-egg mixture and remaining ingredients in order listed into the Baking Pan.
- Insert Baking Pan into oven chamber; twist to secure. Close lid.
- Select: Dough/Pasta Setting.**
- Press Start - There will be a 25-minute preheat delay before mixing begins.
- Allow to mix until the "Add Ingredient" signal beeps (in 45-50 minutes).
- Press Start/Reset button to STOP cycle.
- Remove pasta dough from the Baking Pan and divide into 3 portions. Cover the 2 portions waiting to be rolled.
- Set smooth rollers of a pasta machine as far apart as possible. Feed through one piece of dough. Fold in half both lengthwise and crosswise as required and re-roll 4-6 more times until smooth, shiny and elastic. Start to roll dough thinner by increasing number setting, until dough is 1/16" - 1/8" or desired thickness.
- Move handle of pasta machine to desired cutter blade and roll through onto lightly floured towel. Repeat with remaining 2 portions of pasta dough. Dry for 10 minutes. Cook, or cover and refrigerate for use within 24 hours or freeze for use within a month.
- To cook pasta: Bring a large volume of water to a boil in a large pot. Add small amount of salt and oil to the water. Add pasta and bring back to the boil. Continue to boil 3-5 minutes or until pasta is al dente (firm, but cooked). Drain and add favorite sauce.

SPINACH PASTA DOUGH

American	Dough Recipe	Canadian
1/3 cup	water	1/3 cup
1	egg, beaten	1
3 tbsp.	frozen spinach, drained finely chopped	3 tbsp.
2 tbsp.	olive oil	2 tbsp.
1/2 tsp.	salt	1/2 tsp.
2-3/4 cups	semolina/pasta flour	2-1/2 cups

- Mix water and egg with a fork.
- Add water-egg mixture and remaining ingredients in order listed into the Baking Pan.
- Insert Baking Pan into oven chamber; twist to secure. Close lid.
- Select: Dough/Pasta Setting.**
- Press Start - There will be a 25-minute preheat delay before mixing begins.
- Allow to mix until the "Add Ingredient" signal beeps (in 45-50 minutes).
- Press Start/Reset button to STOP cycle.
- Remove pasta dough from the Baking Pan and divide into 3 portions. Cover the 2 portions waiting to be rolled.
- Set smooth rollers of a pasta machine as far apart as possible. Feed through one piece of dough. Fold in half both lengthwise and crosswise as required and re-roll 4-6 more times until smooth, shiny and elastic. Start to roll dough thinner by increasing number setting, until dough is 1/16" - 1/8" or desired thickness.
- Move handle of pasta machine to desired cutter blade and roll through onto lightly floured towel. Repeat with remaining 2 portions of pasta dough. Dry for 10 minutes. Cook, or cover and refrigerate for use within 24 hours or freeze for use within a month.
- To cook pasta: Bring a large volume of water to a boil in a large pot. Add small amount of salt and oil to the water. Add pasta and bring back to the boil. Continue to boil 3-5 minutes or until pasta is al dente (firm, but cooked). Drain and add favorite sauce.

▲ Helpful Tip

Remember, pasta dough will be ready when the "Add-Ingredient" signal beeps. That means you will have pasta dough in about 45-50 minutes.
If your pasta dough is sticky, simply add a little more semolina flour or chill before shaping.

Need Help?



Questions About The Breadmaker :

Q1:
What do I do if the mixing paddle stays in the loaf? Is this normal? How do I remove the paddle?

The mixing paddle may stay in the loaf when the bread is removed from the bread pan. This happens because the crust forms around the paddle during the baking process. Allow the loaf to cool before removing the mixing paddle (the inside of the loaf is VERY HOT- you may burn yourself if you try to remove the paddle too soon.)

When the loaf has cooled, use a plastic spoon or rubber spatula to remove the paddle. Gently insert the spoon/spatula into the bottom of the loaf and loosen the crust from the paddle. Pull the paddle out. DO NOT use a sharp object (knife, metal utensil) as it will scratch the non-stick coating on the mixing paddle.

Q2:
What do I do if the mixing paddle is hard to remove from the baking Pan after baking?

Remove the Baking Pan from the unit and fill with hot water allowing it to soak for 30 minutes to an hour. Next, pour out the water, turn the Pan over and wiggle the Paddle loose while holding the winged coupling on the bottom of the Pan. Using a toothpick or soft kitchen brush clean out any dough left in the hole of the Paddle.

Q3:
Is there any time that I should not use the delayed start feature?

Yes, when the recipe calls for perishable ingredients such as milk, cheese, buttermilk, or eggs. These foods should not stay at room temperature for an extended period of time. With some recipes, you may substitute powdered milk.

Q4:
Can I open the lid while the breadmaker is operating?

This breadmaker is designed with a window in the lid to let you watch your bread's progress. Quick checks are fine in the early stages of operation and of course to add ingredients when the beeper sounds. However, don't open the lid too frequently during operation as the change in air temperature may cause the loaf to fall. Avoid opening the lid once the baking period begins—the last hour of the cycle. Sometimes condensation forms on the window after initial mixing and kneading. It usually disappears once the baking cycle starts so you should be able to get a clear view of your rising loaf.

Q5:
Where is the OFF button?

Since the breadmaker shuts off its "processing" automatically once the bread or dough cycle is complete and the "Keeps Warm" cycle ends, there is no OFF button. However, the power light will remain on until the unit is unplugged or the Start/Reset button is pressed and held.

Q6:
If the power goes out while I'm in the middle of a breadmaking cycle, will my Breadmaker continue to process my bread once the power comes back on?

The breadmaker will only finish making bread if the power returns within 20 seconds. Unfortunately, if your power outage is longer, you will have to discard the unfinished bread and start the process from the beginning.

Q7:
What is the minimum and maximum time cycle can be delayed?

You can delay baking for a maximum of 13 hours for any bread type setting except rapid bake. The rapid bake setting is designed to bake bread in under 2 hours.

The minimum time you can delay baking is one minute longer than the completion time for the selected bread type setting.

Questions About Ingredients/Recipes :

Q8:
When do I add raisins, nuts, etc. to the bread?

This breadmaker has an "Add-Ingredient" function that signals with an audible tone to let you know when you may add raisins, nuts, caraway seeds, etc. (**NOTE:** The time of the tone varies from one setting to another. Consult the "Add-Ingredient" chart on page 10.) The "Add-Ingredient" feature helps reduce the breaking up of added foods. If you are using the Timer and it is more convenient, you may add ingredients at the start.

Q9:
May I use a sugar substitute in place of sugar?

Sugar is necessary for the yeast to produce a light loaf with a good height. Results may vary with the type and amount of sugar substitute used. If you are going to use an artificial sweetener choose one that is aspartame based rather than saccharin based.

Q10:
May I omit the salt or sugar from the recipe?

No, both the sugar and salt play an important role in the bread making process. Salt prevents the yeast from over-reacting and the bread from over-rising. The combination of sugar, salt, and yeast is a very important part of the bread making process. Remember that the total sugar and salt amounts are divided among all the slices, so the amount of sugar and salt per serving is small.

Need Help?



Q11:
When I make dough, it is very sticky and difficult to work with. How can I handle it more easily?

Dough may be somewhat sticky at the end of the dough cycle. This is normal. For best results, turn it out of the Baking Pan onto a floured surface, cover it and let it rest for 10 minutes. Lightly flour the board and your hands when handling the dough. This will make it easier to shape and divide. Once shaped, the dough must be baked in a conventional oven.

Q12:
Can I bake products formed from doughs in my microwave oven?

No, once shaped, the dough must be baked in a conventional oven.

Q13:
How do I know when dough is ready to bake?

Dough should have doubled in size.

Q14:
How does the pasta come out of the Breadmaker?

This breadmaker includes a setting to make dough for pasta. However, once the pasta dough is completed, it must be removed and shaped just like any dough must be rolled, braided, or otherwise shaped. You may use a pasta maker or pasta shaper (there are special pans – similar to muffin tins – to shape ravioli and some other kinds of filled pasta) to shape your pasta. Pasta dough does not need to rise, therefore it can be removed from the breadmaker according to the instructions in the recipes, see page 30.

Q15:
Why do the loaves vary in height and weight? The whole wheat and multi-grain breads are frequently shorter. Am I doing something wrong?

No, it is normal for whole wheat and multi-grain breads to be shorter and denser than basic white breads. Whole wheat and rye flours are heavier than white flour, therefore, they don't rise as much during the bread making process. They also typically have added ingredients, such as oats, bran, nuts and raisins, which contribute to the shorter height and denser texture.

Q16:
What is gluten?

Gluten is the protein in flour that makes dough elastic and allows it to stretch and expand. It gives your bread structure. The amount of gluten varies from one flour to another.

Q17:
Can I use my favorite bread recipes in my bread machine?

Yes, but you will need to experiment to get the right proportion of ingredients. Become familiar with the unit and make several loaves of bread before you begin experimenting. Never exceed a total amount of 4-2/3 cups (U.S) or 4 cups (Cdn.) dry ingredients (that includes flours,

oats, cornmeal, bran cereal, cracked wheat, etc.). Use the recipes in this book to help determine the ratio of dry ingredients to liquid and amounts of yeast, sugar, salt, and shortening (or butter/margarine) to use.

Q18:
Why does some flour occasionally stick to the side of the bread?

There are many factors that may affect whether a dough mixes completely or ingredients stick to the sides:

- Dough may be too dry (ingredients may have been measured incorrectly).
- Mixing Paddle was not placed correctly in the Baking Pan. Be sure it is pushed securely onto the shaft.
- Baking Pan is not placed in the unit correctly. Be sure to "lock" the Pan into place.
- Ingredients were not added in the recommended order. It is very important to add ingredients in the order listed in the recipe and to measure accurately.

Sometimes during the initial mixing period, small amounts of flour and dry ingredients may get stuck to the sides of the Baking Pan. When the loaf rises and bakes, the dry ingredients may stick to the bread. Once the loaf is removed from the Baking Pan and has cooled 10-15 minutes, the dry ingredients may be scraped off the loaf easily with a knife.

Q19:
Can I make cakes and quick breads (breads that do not use yeast) in my breadmaker?

No, the breadmaker is designed to mix, knead, and bake yeast breads. It is not recommended for use with non-yeast foods, such as cakes, cookie dough or quick breads. These foods use leavening agents (baking powder, and/or baking soda) that react best with short mixing and baking. If you are looking for something to satisfy your sweet tooth, there are several recipes in this book for sweet breads.

Q20:
Why does my bread rise and then collapse or form craters?

Your bread may be rising too fast. To decrease the rate of rising, try reducing the amount of sugar, increasing the amount of salt slightly, or reducing the amount of yeast. Refer to the "Trouble Shooting Guide" on pg. 12 for correct adjustments.

Q21:
Is it important for ingredients to be at room temperature before adding them to the Baking Pan?

No, as long as ingredients are not extremely cold or hot. Milk, eggs, butter/margarine, and yeast can be added directly from the refrigerator with good results. When a recipe calls for water, use lukewarm water since it's easy to get from the tap.

Need Help?



Q22:

Which kind of yeast is the best to use?

Yeast specially packaged for Bread Machines, Traditional Dry Yeast, Rapid Rise, or Quick Rise Yeast, can all be used with good results. The most important thing is to be sure the expiration date is not up. All the recipes in this cookbook were developed using Bread Machine Yeast. If you prefer to use Traditional, Quick Rise or Rapid Rise Yeast, increase the amount of yeast you use in the recipe by 1/4 teaspoon.

Q23:

Sometimes when I cut my bread, it's too sticky and it falls apart or it starts to mash down and won't slice cleanly. What can I do?

If your bread is sticky or mashes down, it may be too hot! Be sure to allow 15 to 30 minutes for your bread to cool before slicing. Place finished bread on a wire cooling rack to let air circulate around it. You may want to try using an electric knife to slice bread instead of cutting it manually. An electric knife has blades that slide back and forth to let you slice straight through bread and avoid mashing it down by putting pressure on the top of the loaf.

Q24:

Why did I end up with a short, dense, doughy bread? Why didn't the bread rise?

The most common reason for unrisen bread is the yeast. Maybe you forgot to add the yeast. Perhaps the yeast was bad or expired (always check expiration dates). Also, if the mixing wasn't complete, you may have rising problems. Did you check to see if the mixing paddle was moving at the beginning of your cycle?

Q25:

What will happen if I leave the bread in the Baking Pan after baking?

This unit has a 60-minute "Keep Warm" cycle that lets you leave the bread in the pan for up to an hour after baking is completed. Once that warming cycle is over, it's best to remove the bread immediately or the bottom of your loaf will absorb moisture and become soggy. The soggy part of the bread will not be as tasty when it dries out and it will go stale quickly. The sides of the bread may also become moist and mushy.

Q26:

Can the recipe be cut in half?

No, the recipe can not be cut in half as temperatures are programmed for either a 1.5 or 2.0 lb loaf. For a smaller loaf, use the recipe developed for the 1.5 lb loaf. If you want to reduce wastage, you can freeze half the loaf for later use.

Q27:

How can bread mixes be used in the machine and at what setting?

The package instructions will list the amount of water and amount of yeast to use. Be sure to add liquid, then dry ingredients, followed by yeast. Remember not to allow the yeast to sit in the liquid.

The bread type setting is dependent upon the type of bread mix being used. i.e. White bread uses the Basic Bread setting; Sweet Bread setting is for use with dried fruit, cheese or nuts; Whole wheat or multi-grain should use the Whole Grain setting. Crust setting either Regular or Dark, is a personal preference.

Other Questions?



Please Call Us Toll Free!

1-800-465-6070 in Canada &

1-800-231-9786 in the U.S.

Notes



A large area for taking notes, consisting of two columns of horizontal lines. Each column has 20 lines, for a total of 40 lines across the page.