

**HONDA**  
**MARINE**

**BF200A/BF225A**  
**Owner's Manual**

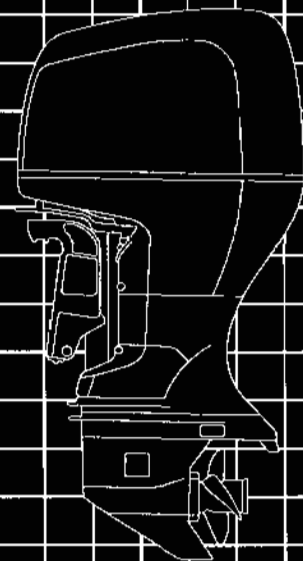



## **WARNING:**



The engine exhaust from this product contains chemicals known to the State of California to cause cancer, birth defects, or other reproductive harm.

Keep this owner's manual handy, so you can refer to it at any time. This owner's manual is considered a permanent part of the outboard motor and should remain with the outboard motor if resold.

The information and specifications included in this publication were in effect at the time of approval for printing. Honda Motor Co., Ltd. reserves the right, however, to discontinue or change specifications or design at any time without notice and without incurring any obligation whatever. No part of this publication may be reproduced without written permission.

# INTRODUCTION

Congratulations on your selection of a Honda outboard motor. We are certain you will be pleased with your purchase of one of the finest outboard motors on the market.

We want to help you get the best results from your new outboard motor and to operate it safely. This manual contains the information on how to do that; please read it carefully.

As you read this manual you will find information preceded by a

**NOTICE** symbol. That information is intended to help you avoid damage to your outboard motor, other property, or the environment.

We suggest you read the warranty policy to fully understand its coverage and your responsibilities of ownership. The warranty policy is a separate document that should have been given to you by your dealer.

When your outboard motor needs scheduled maintenance, keep in mind that your Honda marine dealer is specially trained in servicing Honda outboard motors. Your Honda marine dealer is dedicated to your satisfaction and will be pleased to answer your questions and concerns.

© 2001 Honda Motor Co., Ltd. All Rights Reserved

# INTRODUCTION

---

## A FEW WORDS ABOUT SAFETY

Your safety and the safety of others are very important. And using this outboard motor safely is an important responsibility.



To help you make informed decisions about safety, we have provided operating procedures and other information on labels and in this manual. This information alerts you to potential hazards that could hurt you or others.

Of course, it is not practical or possible to warn you about all the hazards associated with operating or maintaining an outboard motor. You must use your own good judgment.

You will find important safety information in a variety of forms, including:

- **Safety Labels** — on the outboard motor.
- **Safety Messages** — preceded by a safety alert symbol  and one of three signal words, DANGER, WARNING, or CAUTION.

These signal words mean:

- |  |   |
|--|---|
|  <b>DANGER</b>  | You <b>WILL</b> be <b>KILLED</b> or <b>SERIOUSLY HURT</b> if you don't follow instructions. |
|  <b>WARNING</b> | You <b>CAN</b> be <b>KILLED</b> or <b>SERIOUSLY HURT</b> if you don't follow instructions.  |
|  <b>CAUTION</b> | You <b>CAN</b> be <b>HURT</b> if you don't follow instructions.                             |

- **Safety Headings** — such as *IMPORTANT SAFETY INFORMATION*.
- **Safety Section** — such as *OUTBOARD MOTOR SAFETY*.
- **Instructions** — how to use this outboard motor correctly and safely.

This entire book is filled with important safety information — please read it carefully.

# CONTENTS

OUTBOARD MOTOR SAFETY.....	7
IMPORTANT SAFETY INFORMATION.....	7
SAFETY LABEL LOCATIONS.....	9
CONTROLS AND FEATURES .....	10
CONTROL AND FEATURE IDENTIFICATION	
CODES.....	10
COMPONENT AND CONTROL LOCATIONS.....	11
CONTROLS.....	15
Side-Mount Type	
Ignition Switch.....	15
Switch Clip and Emergency Stop Switch.....	16
Gearshift/Throttle Control Lever.....	16
Fast Idle Lever.....	18
Panel-Mount Type	
Ignition Switch.....	18
Switch Clip and Emergency Stop Switch.....	19
Throttle Button.....	20
Gearshift/Throttle Control Lever.....	20

Top-Mount Type	
Ignition Switch.....	22
Switch Clip and Emergency Stop Switch.....	22
Fast Idle Button.....	23
Gearshift/Throttle Control Lever.....	23
Common Controls	
Power Trim/Tilt Switch.....	25
Power Tilt Switch.....	26
Manual Relief Valve.....	26
Tilt Lock Lever.....	26
Engine Cover Latch.....	27
Trim Tab.....	27
INSTRUMENTS.....	27
Trim Meter (optional equipment).....	27
Tachometer (optional equipment).....	28

# CONTENTS

---

INDICATORS.....	28	OPERATION.....	34
Alternator (AGC) Indicator.....	28	SAFE OPERATING PRECAUTIONS.....	34
Programmed Fuel Injection (PGM-FI) Indicator...	28	BREAK-IN PROCEDURE.....	34
Oil Pressure Indicator.....	29	FUEL PRIMING.....	35
Overheating Indicator.....	29	STARTING THE ENGINE.....	36
Cooling System Indicator.....	30	Side-Mount Type.....	36
OTHER FEATURES.....	30	Panel-Mount Type.....	39
Water Contamination Buzzer.....	30	Top-Mount Type.....	41
Overrev Limiter.....	31	STOPPING THE ENGINE.....	43
Anodes.....	31	Emergency Engine Stopping.....	43
Fuel Priming Bulb.....	31	Normal Engine Stopping.....	44
BEFORE OPERATION.....	32	GEARSHIFTING AND	
ARE YOU READY TO GET UNDER WAY ? .....	32	THROTTLE OPERATION.....	45
IS YOUR OUTBOARD MOTOR		Side-Mount Type.....	45
READY TO GO ? .....	32	Panel-Mount Type.....	46
		Top-Mount Type.....	46
		STEERING.....	47
		CRUISING.....	48
		SHALLOW WATER OPERATION.....	50
		MOORING, BEACHING, LAUNCHING.....	50

SERVICING YOUR OUTBOARD MOTOR .....	52	Spark Plug Service .....	64
THE IMPORTANCE OF MAINTENANCE .....	52	FUEL RECOMMENDATIONS .....	68
MAINTENANCE SAFETY .....	53	Fuel Pump Filter Inspection and Replacement .....	69
TOOL KIT (optional equipment).....	54	Water Separator.....	71
MAINTENANCE SCHEDULE .....	55	Anode Replacement .....	73
TRIM TAB ADJUSTMENT .....	57	Propeller Replacement .....	74
MANUAL RELIEF VALVE.....	58	STORAGE .....	75
ENGINE COVER REMOVAL AND		STORAGE PREPARATION .....	75
INSTALLATION.....	58	Cleaning and Flushing .....	75
Latch Adjustment .....	59	Fuel.....	77
Cover Lock Bolt Adjustment .....	59	Engine Oil .....	78
Engine Oil Level Check .....	60	HOISTING THE OUTBOARD MOTOR.....	78
Engine Oil Change .....	60	STORAGE PRECAUTIONS .....	79
Engine Oil Recommendations .....	62	REMOVAL FROM STORAGE.....	80
Lubrication Points .....	63		

# CONTENTS

---

TRANSPORTING .....	81	INDEX.....	104
WITH OUTBOARD MOTOR		WIRING DIAGRAMS.....	Inside Back Cover
INSTALLED ON BOAT .....	81		
WITH OUTBOARD MOTOR			
REMOVED FROM BOAT .....	81		
TAKING CARE OF UNEXPECTED PROBLEMS.....	82		
BATTERY WILL NOT CHARGE AND			
ELECTRIC STARTER WILL NOT			
OPERATE.....	87		
OIL PRESSURE INDICATOR LIGHT GOES OFF			
AND ENGINE SPEED IS LIMITED.....	89		
OVERHEATING INDICATOR LIGHT COMES			
ON AND ENGINE SPEED IS LIMITED.....	90		
SUBMERGED MOTOR .....	91		
TECHNICAL AND CONSUMER INFORMATION... 93			
TECHNICAL INFORMATION .....	93		
Serial Number Locations .....	93		
Oxygenated Fuels.....	94		
Battery .....	95		
Emission Control System Information .....	96		
Star Label .....	98		
Specifications .....	100		
CONSUMER INFORMATION .....	103		



# OUTBOARD MOTOR SAFETY

## IMPORTANT SAFETY INFORMATION

Honda BF200A/BF225A outboard motors are designed for use with boats that have a suitable manufacturer's power recommendation. Other uses can result in injury to the operator or damage to the outboard motor and other property.

Most accidents can be prevented if you follow all instructions in this manual and on the outboard motor. The most common hazards are discussed below, along with the best way to protect yourself and others.

## Operator Responsibility

- It is the operator's responsibility to provide the necessary safeguards to protect people and property. Know how to stop the engine quickly in case of emergency. Understand the use of all controls.
- Stop the engine immediately if anyone falls overboard, and do not run the engine while the boat is near anyone in the water.
- Always stop the engine if you must leave the controls for any reason.
- Attach the emergency stop switch lanyard securely to the operator.
- Always wear a PFD (Personal Flotation Device) while on the boat.
- Familiarize yourself with all laws and regulations relating to boating and the use of outboard motors.
- Be sure that anyone who operates the outboard motor receives proper instruction.
- Be sure the outboard motor is properly mounted on the boat.
- Do not remove the engine cover while the engine is running.

## OUTBOARD MOTOR SAFETY

---

### Refuel With Care

- Gasoline is extremely flammable, and gasoline vapor can explode. Refuel outdoors, in a well-ventilated area, with the engine stopped. Never smoke near gasoline, and keep other flames and sparks away.
- Refuel carefully to avoid spilling fuel. Avoid overfilling the fuel tank.
- After refueling, tighten the filler cap securely. If any fuel is spilled, make sure the area is dry before starting the engine.

### Carbon Monoxide Hazard

Exhaust gas contains poisonous carbon monoxide. Avoid inhalation of exhaust gas. Never run the engine in a closed garage or confined area.

## SAFETY LABEL LOCATIONS

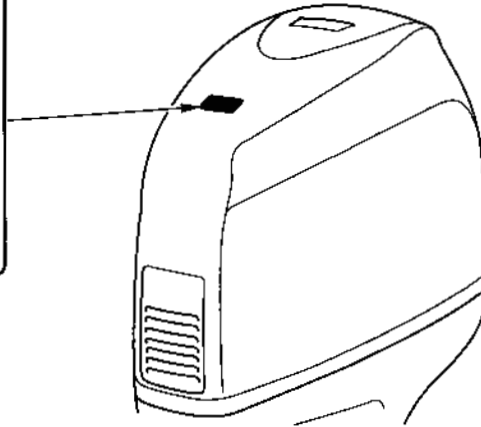
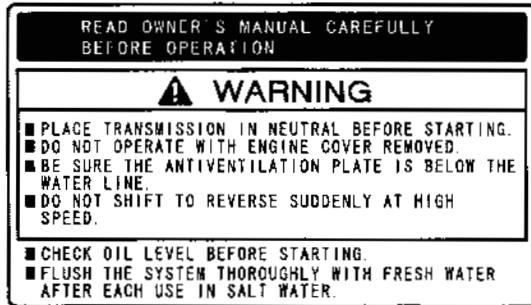

The labels shown here contain important safety information. Please read them carefully. These labels are considered permanent parts of your outboard motor. If a label comes off or becomes hard to read, contact an authorized Honda Marine servicing dealer for a replacement.



## COMPONENT AND CONTROL LOCATIONS

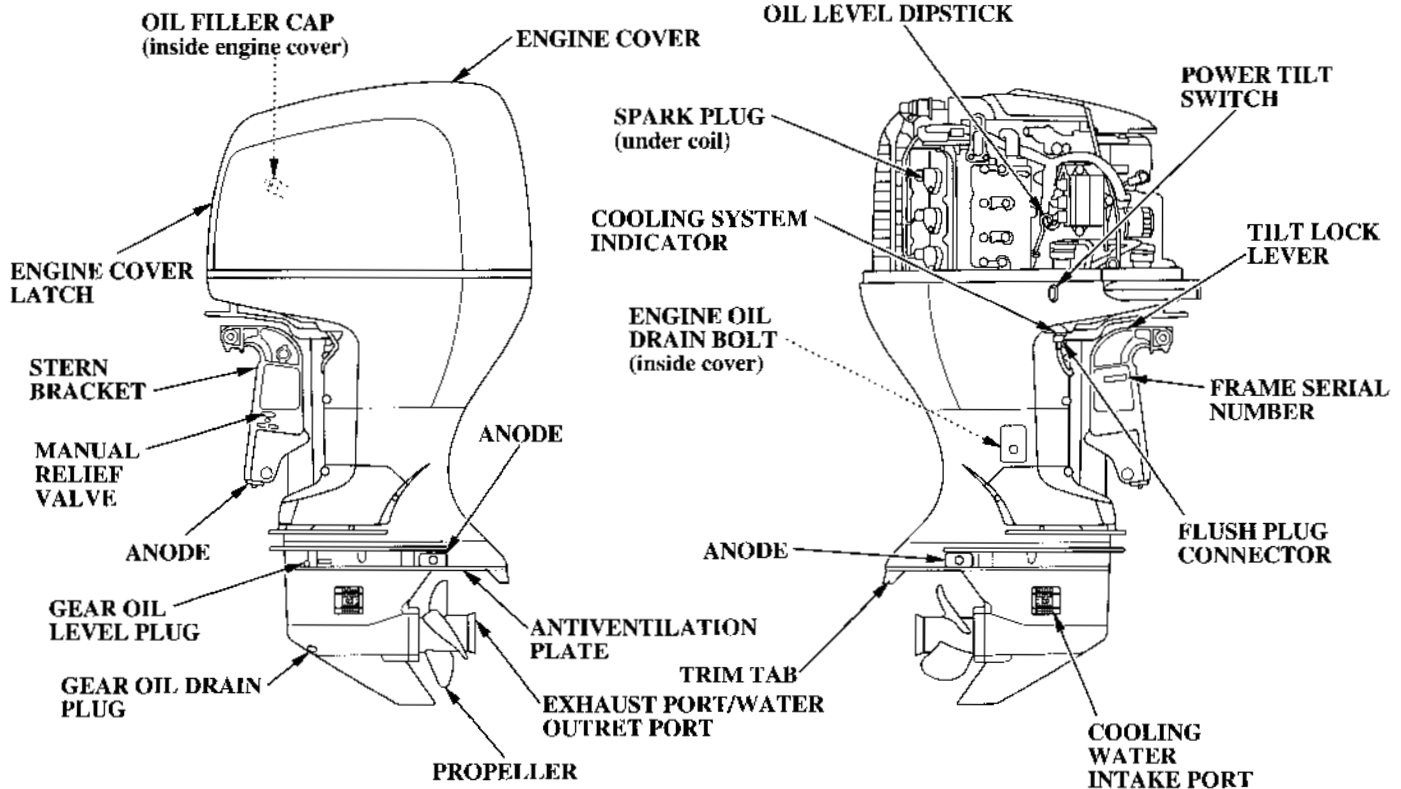

# CONTROLS AND FEATURES

---

## Remote Controls (optional equipment)

(SIDE-MOUNT REMOTE CONTROL)

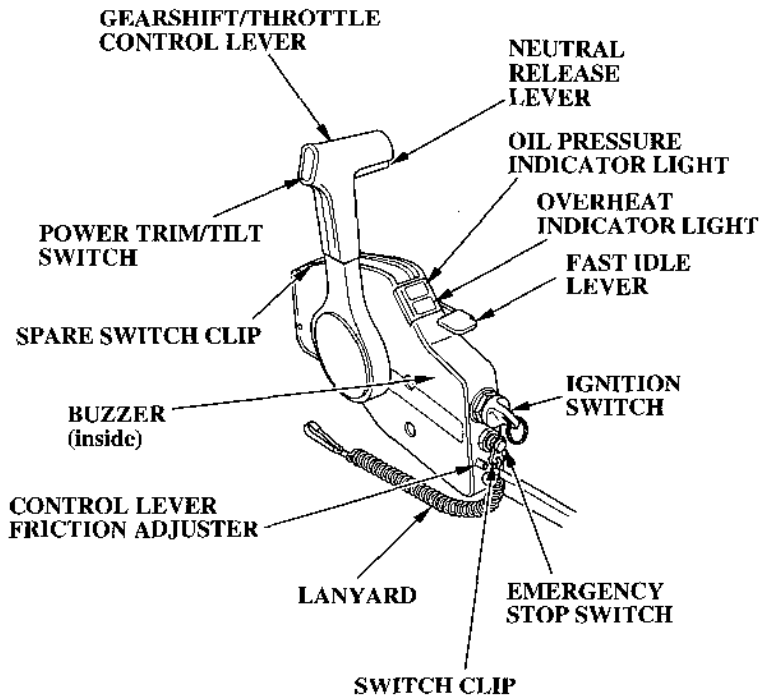

(PANEL-MOUNT REMOTE CONTROL)

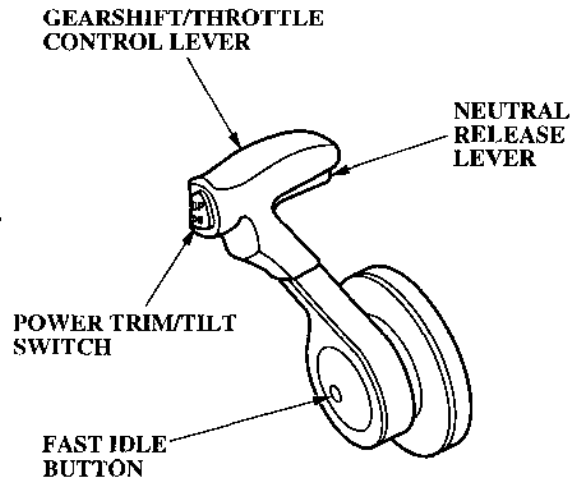

# CONTROLS AND FEATURES

(SINGLE TOP-MOUNT REMOTE CONTROL)

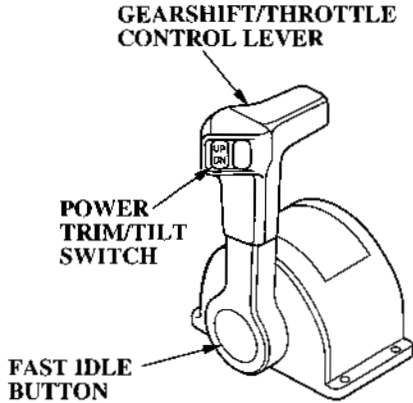

(DUAL TOP-MOUNT REMOTE CONTROL)

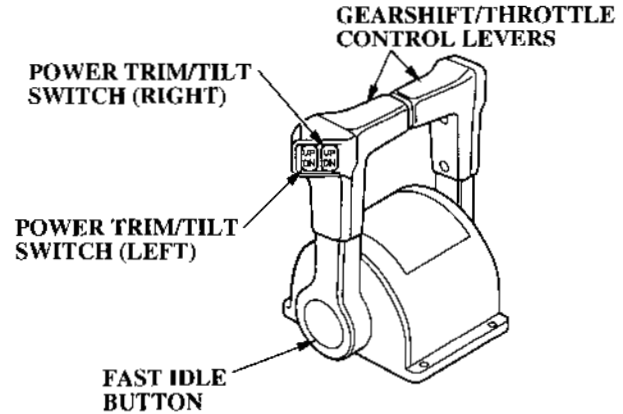

CONTROL PANEL  
(for PANEL/TOP-MOUNT type)

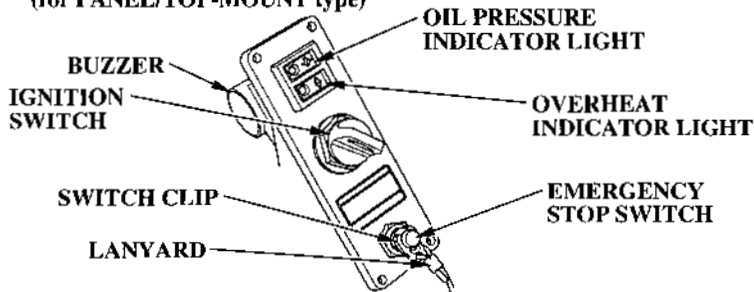

(for TOP-MOUNT DUAL type)

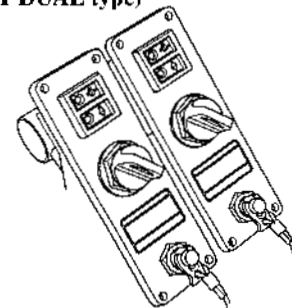

## CONTROLS AND FEATURES

---

**Trim Meter**  
(optional equipment)

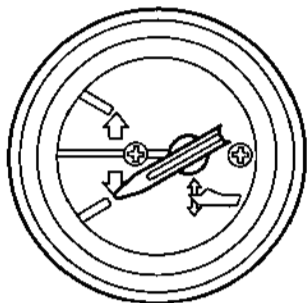



## CONTROLS

### Side-Mount Type

#### *Ignition Switch*

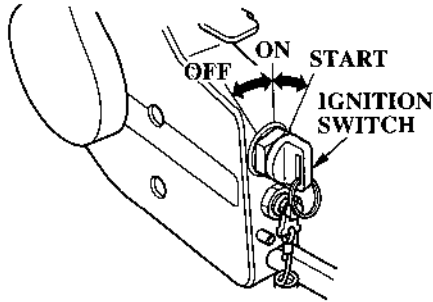

The ignition switch controls the ignition system and starter motor.

Turning the ignition switch key to the START position operates the starter motor. The key automatically returns to the ON position when released from the START position.

The ignition switch can be used to operate the starter motor only when the control lever (p. 17 ) is in the N (neutral) position, and the switch clip is in the emergency stop switch.

Turning the ignition switch to the OFF position stops the engine.

## CONTROLS AND FEATURES

### *Switch Clip and Emergency Stop Switch*

EMERGENCY STOP SWITCH

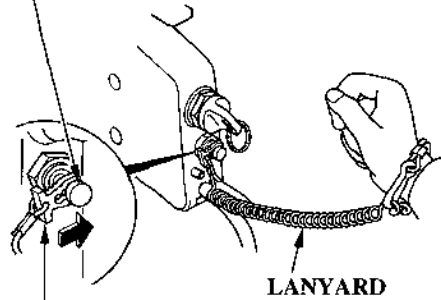

SWITCH CLIP

LANYARD

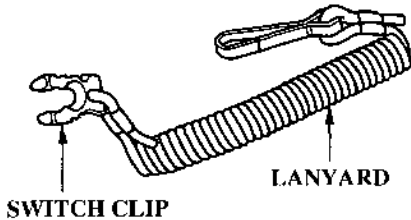

SWITCH CLIP

LANYARD

The switch clip must be inserted in the emergency stop switch in order for the engine to start and run. The lanyard must be attached to the operator's PFD (Personal Flotation Device) or worn around the wrist as shown.

When used as described, the emergency stop switch and lanyard system stops the engine if the operator falls away from the controls.

A spare switch clip is stored in a slot in the control housing (optional equipment).

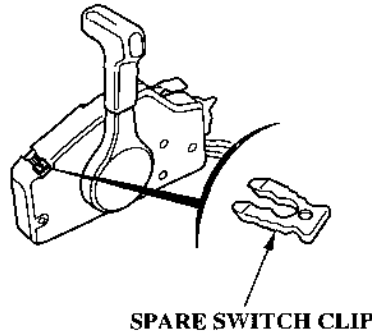

SPARE SWITCH CLIP

### *Gearshift/Throttle Control Lever*

CONTROL LEVER

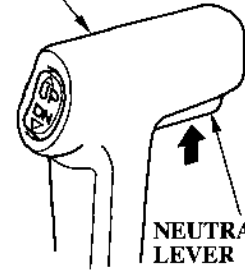

NEUTRAL RELEASE LEVER

The gearshift/throttle control lever controls engine speed and selects F (forward), N (neutral), or R (reverse) gears.

## CONTROLS AND FEATURES

Moving the control lever 30° from N (neutral) selects the gear, and further movement increases engine speed.

The control lever automatically locks itself in the N (neutral) position. To move the lever out of the N (neutral) position, you must squeeze the neutral release lever on the underside of the lever handle.

A friction adjuster near the base of the control lever(s) adjusts the operating resistance of the control lever(s).

Less friction allows easier control lever movement. More friction helps to hold a steady throttle setting while cruising.

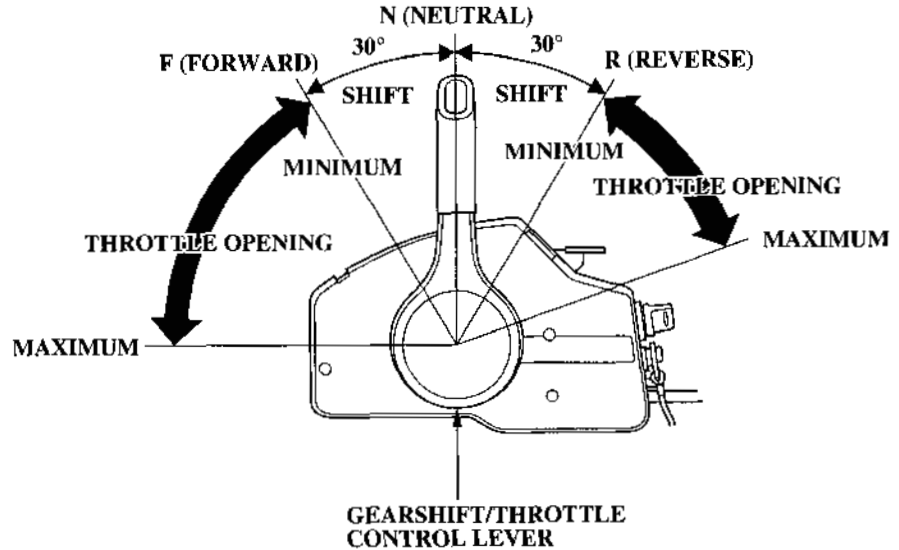

## CONTROLS AND FEATURES

### *Fast Idle Lever*

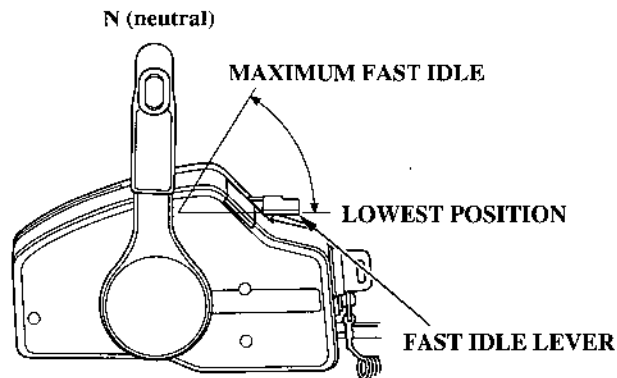

The fast idle lever is only needed for starting carbureted outboard models. The BF200A and BF225A models use programmed fuel injection so, this lever will not be needed for starting.

After the engine starts and if the outside temperature is below 41°F (5°C), the fast idle lever can be used to accelerate engine warm up.

The fast idle lever will not move unless the remote control lever is in the N (neutral) position. Conversely, the remote control lever will not move unless the fast idle lever is in the lowest position.

Lower the fast idle lever to the lowest position to decrease the fast idle.

### *Panel-Mount Type*

### *Ignition Switch*

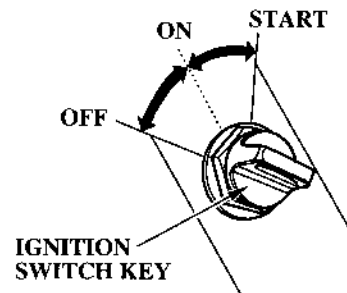

The ignition switch controls the ignition system and starter motor.

Turning the ignition switch key to the **START** position operates the starter motor. The key automatically returns to the **ON** position when released from the **START** position.

The ignition switch can be used to operate the starter motor only when the control lever (p. 21 ) is in the **N** (neutral) position, and the switch clip is in the emergency stop switch.

Turning the ignition switch to the **OFF** position stops the engine.

### **Switch Clip and Emergency Stop Switch**

**EMERGENCY STOP SWITCH**

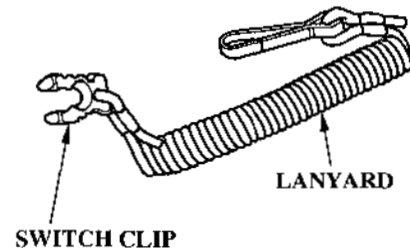
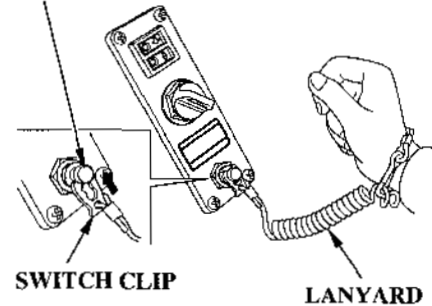

The switch clip must be inserted in the emergency stop switch in order for the engine to start and run. The lanyard must be attached to the operator's PFD (Personal Flotation Device) or worn around the wrist as shown.

When used as described, the emergency stop switch and lanyard system stops the engine if the operator falls away from the controls.

A spare switch clip is stored in the tool bag (optional equipment).



## CONTROLS AND FEATURES

### *Fast Idle Button*

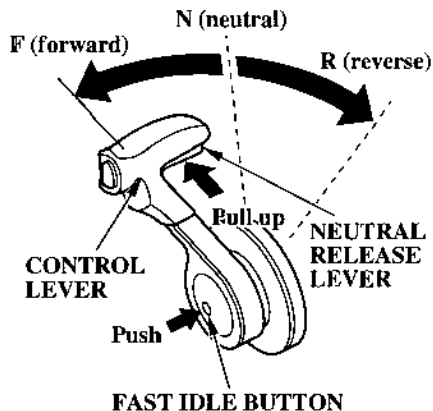

By moving the control lever forward or reverse when the fast idle button is pushed in, the throttle opening will be increased without engaging the gears.

It is necessary to position the control lever in N (neutral) to push in the fast idle button.

### *Gearshift/Throttle Control Lever*

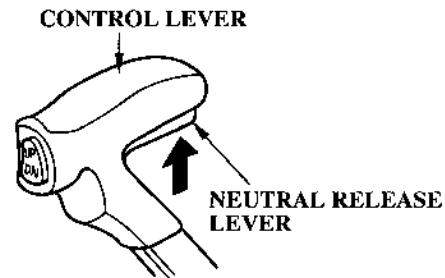

The gearshift/throttle control lever controls engine speed and selects F (forward), N (neutral), or R (reverse) gears.

## CONTROLS AND FEATURES

Moving the control lever 35° from N (neutral) selects the gear, and further movement increases engine speed.

The control lever automatically locks itself in the N (neutral) position. To move the lever out of the N (neutral) position, you must squeeze the neutral release lever on the underside of the lever handle.

A friction adjuster near the base of the control lever adjusts the operating resistance of the control lever.

Less friction allows easier control lever movement. More friction helps to hold a steady throttle setting while cruising.

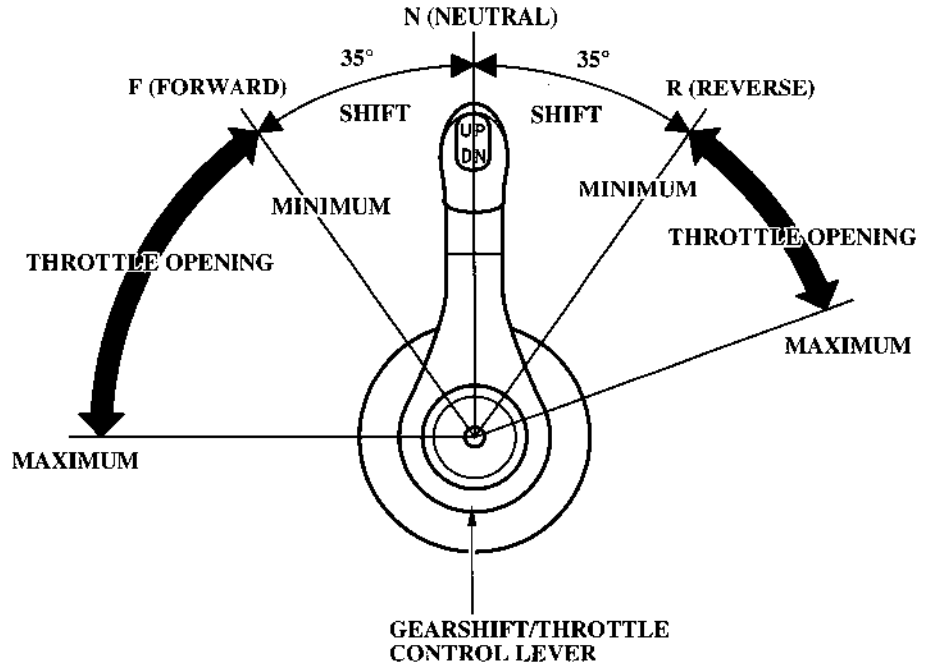

# CONTROLS AND FEATURES

## Top-Mount Type

### Ignition Switch

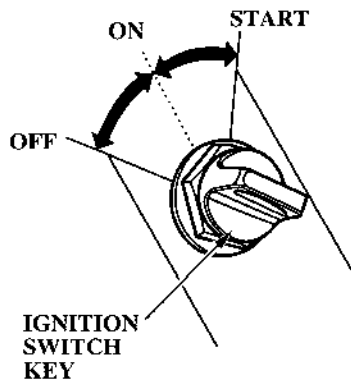

The ignition switch controls the ignition system and starter motor.

Turning the ignition switch key to the START position operates the starter motor. The key automatically returns to the ON position when released from the START position.

The ignition switch can be used to operate the starter motor only when the control lever (p. 24) is in the N (neutral) position, and the switch clip is in the emergency stop switch.

Turning the ignition switch to the OFF position stops the engine.

### Switch Clip and Emergency Stop Switch

#### EMERGENCY STOP SWITCH

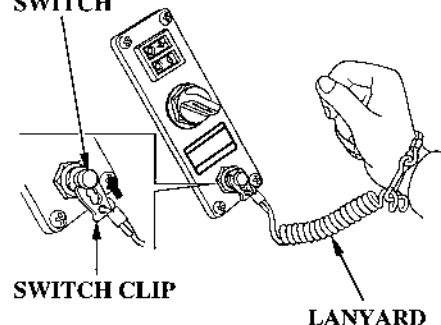

SWITCH CLIP

LANYARD

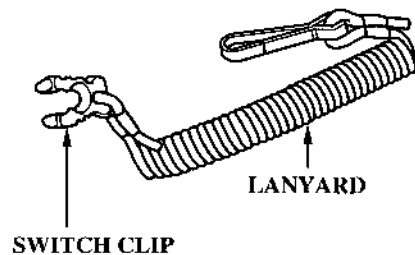

SWITCH CLIP

LANYARD



The switch clip must be inserted in the emergency stop switch in order for the engine to start and run. The lanyard must be attached to the operator's PFD (Personal Flotation Device) or worn around the wrist as shown.

When used as described, the emergency stop switch and lanyard system stops the engine if the operator falls away from the controls.

A spare switch clip is stored in the tool bag (optional equipment).

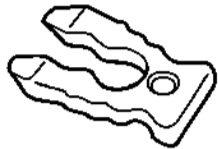

**SPARE SWITCH CLIP**

## *Fast Idle Button*

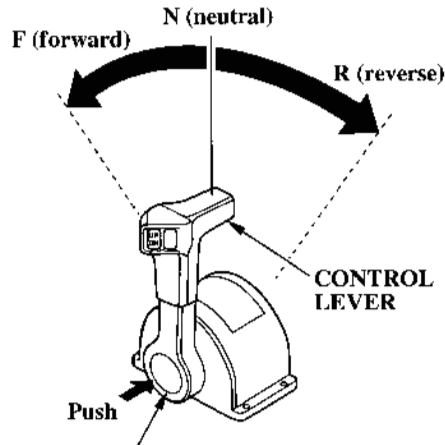

### **FAST IDLE BUTTON**

By moving the control lever forward or reverse when the fast idle button is pushed in, the throttle opening will be increased without engaging the gears.

It is necessary to position the control lever in N (neutral) to push in the fast idle button.

## *Gearshift/Throttle Control Lever*

### **SINGLE TYPE**

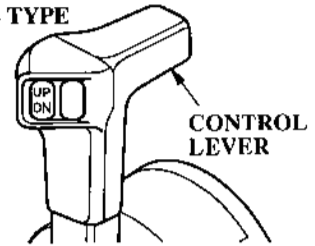

### **DUAL TYPE**

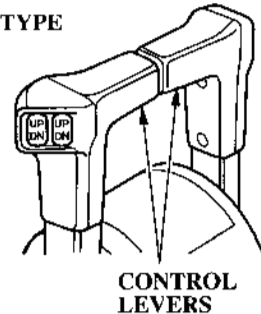

The gearshift/throttle control lever controls engine speed and selects F (forward), N (neutral), or R (reverse) gears.

## CONTROLS AND FEATURES

Moving the control lever 35° from N (neutral) selects the gear, and further movement increases engine speed.

A friction adjuster inside the control box adjusts the operating resistance of the control lever(s).

Less friction allows easier control lever movement. More friction helps to hold a steady throttle setting while cruising.

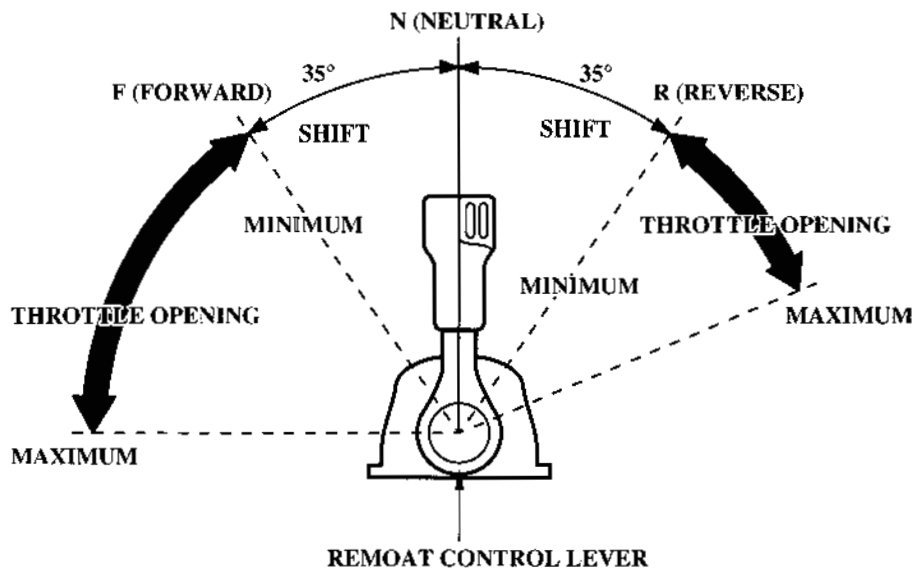

## Common Controls

### Power Trim/Tilt Switch

(side-mount type)

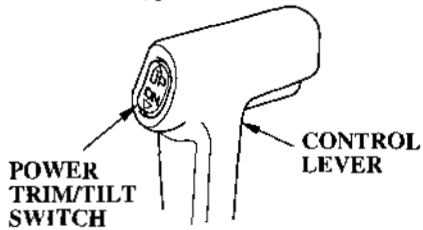

(top-mount type)

SINGLE TYPE  
POWER TRIM/TILT SWITCH

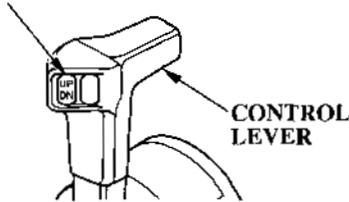

(panel-mount type)

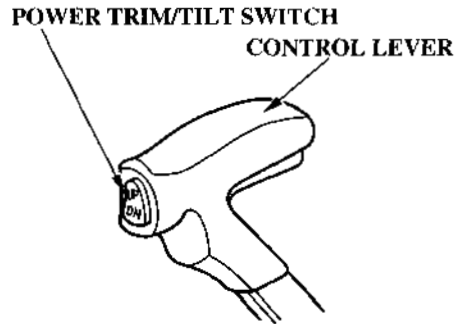

DUAL TYPE  
POWER TRIM/TILT SWITCH  
(LEFT) (RIGHT)

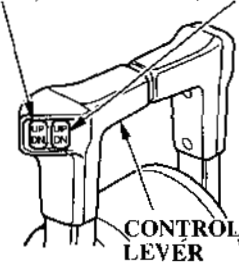

The power trim/tilt switch is located on the control lever. It is a rocker switch with UP and DN (down) positions for changing the angle of the outboard motor.

You can use the power trim/tilt switch anytime the ignition switch is ON, whether the boat is underway or stopped.

Trim the outboard motor to obtain the best performance and stability (p. 48).

Tilt the outboard motor for shallow water operation, beaching, launching, or mooring.

Please tilt up simultaneously, when you mount the dual type outboard motor.

## CONTROLS AND FEATURES

### Power Tilt Switch

POWER TILT SWITCH

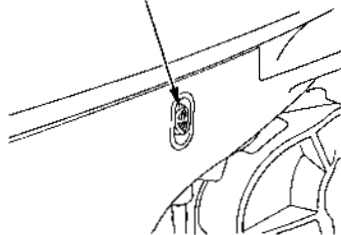

The power tilt switch is located on the engine pan. It is a rocker switch with UP and DN (down) positions for changing the angle of the outboard motor.

The power tilt switch will operate without turning the ignition switch ON.

This switch is used with the engine stopped to raise the outboard motor for mooring, trailering or maintenance.

### Manual Relief Valve

MANUAL RELIEF VALVE

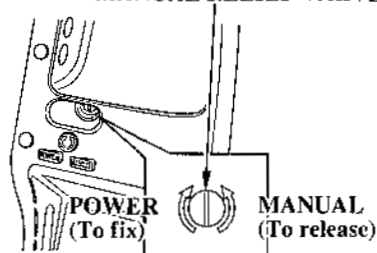

The outboard motor can be tilted manually after opening the manual relief valve. This allows the outboard motor to be tilted when no battery is connected.

### Tilt Lock Lever

TILT LOCK LEVER

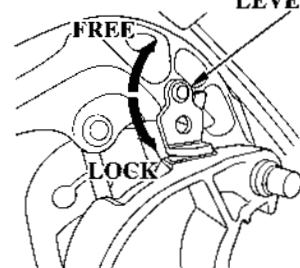

The tilt lock lever is used to support the outboard motor in the fully-raised position.

When the boat is to be moored for a long time, tilt the outboard motor as far as it will go. Then move the tilt lock lever to the LOCK position, and gently lower the outboard motor until the lever contacts the stern bracket.

## Engine Cover Latch

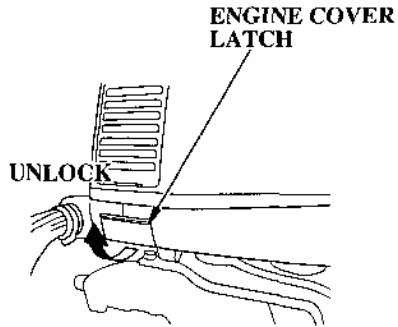

The engine cover latch fastens the engine cover to the outboard motor.

## Trim Tab

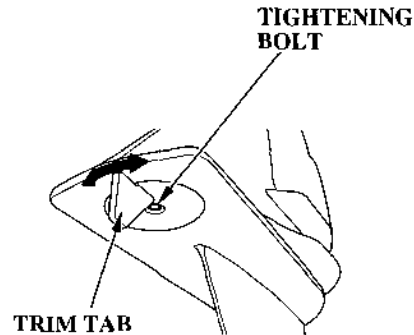

The trim tab compensates for "torque steer," which is a reaction of the outboard motor to propeller rotation.

If uncompensated, torque steer would make the outboard motor tend to turn to one side.

When the trim tab is correctly adjusted (p. 57), steering effort is equal in either direction.

## INSTRUMENTS

### Trim Meter (optional equipment)

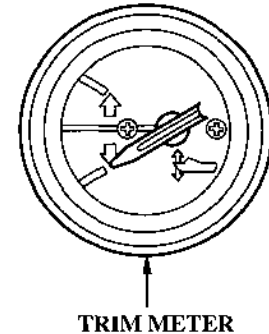

The trim meter has a range of 0° to 20° and indicates the trim angle of the outboard motor.

Refer to the trim meter when using the power trim/tilt switch to achieve the best performance from the boat.

## CONTROLS AND FEATURES

### Tachometer (optional equipment)



TACHOMETER

The tachometer shows engine speed in revolutions per minute.

Refer to the tachometer when using the throttle and power trim/tilt controls to achieve the best performance from the boat.

### INDICATORS

#### Alternator (ACG) Indicator

ACG INDICATOR LIGHT

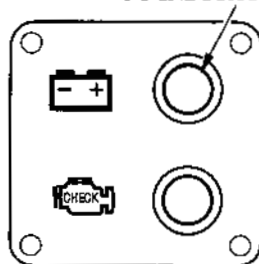

The ACG indicator light turns on and the buzzer sounds when the charging system is faulty.

#### Programmed Fuel Injection (PGM-FI) Indicator

PGM-FI INDICATOR LIGHT

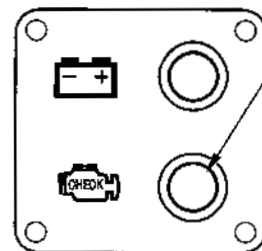

The PGM-FI indicator light turns on and the buzzer sounds when the engine control system detects a malfunction, and momentarily sounds when the ignition key is turned from OFF to ON.

## Oil Pressure Indicator

(side-mount type)

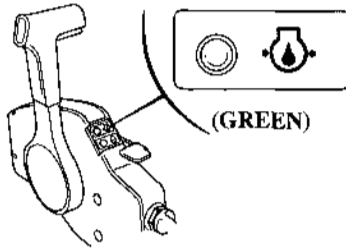

(panel-mount/top-mount types)

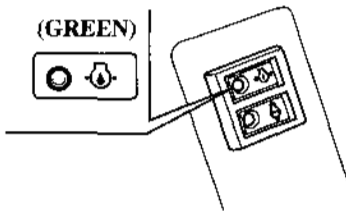

When the green light is lit, oil pressure is OK.

If oil pressure becomes low, the green light will go off, and the engine protection system will limit engine speed.

Remote controls are also equipped with a buzzer that sounds when the green light goes off.

Low oil pressure indicates that the engine oil level is low, or that there is a problem with the engine lubrication system.

## Overheating Indicator

(side-mount type)

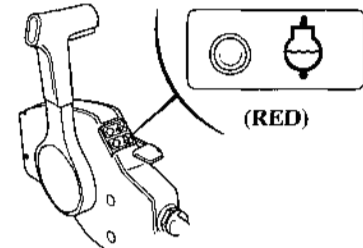

(panel-mount/top-mount types)

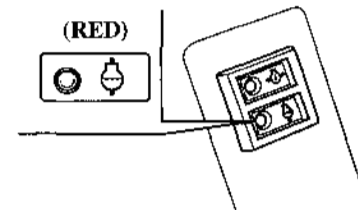

## CONTROLS AND FEATURES

If the engine overheats, the red light will come on, and the engine will stop in 20 seconds after the engine protection system will limit engine speed.

Remote controls are also equipped with a buzzer that sounds when the red light comes on.

Engine overheating may be the result of clogged water intakes.

### Cooling System Indicator

#### COOLING SYSTEM INDICATOR

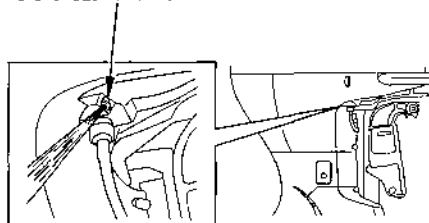

Water should flow from the cooling system indicator while the engine is running. This shows that water is circulating through the cooling system.

If water stops flowing while the engine is running, that indicates a cooling system problem, such as clogged water intakes, which will cause engine overheating.

### OTHER FEATURES

#### Water Contamination Buzzer

The water contamination buzzer sounds when water has accumulated in the water separator.



## Overrev Limiter

The engine is equipped with an overrev limiter to prevent the possibility of mechanical damage from excessive engine speed.

The overrev limiter may be activated during operation, limiting engine speed, if the outboard motor is tilted excessively, or when ventilation occurs during a sharp turn.

If the overrev limiter is activated, check the trim angle of the outboard motor.

Check to see if the correct propeller is installed.

## Anodes

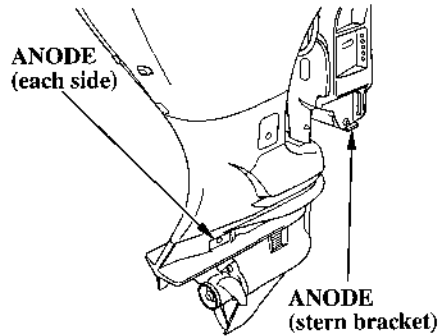

The anodes are made of a sacrificial material that helps to protect the outboard motor from corrosion.

There are two anodes on the gear case, one on the stern bracket, and two small anodes in the water passages of the engine block.

## Fuel Priming Bulb

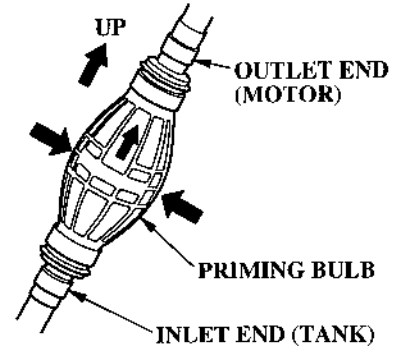

A priming bulb is built into the fuel hose that connects the fuel tank to the outboard motor.

Before starting the engine, hold the priming bulb up in the direction of the arrow, then squeeze the priming bulb until it feels firm. This will ensure that fuel is supplied to the engine (p. 35).

# BEFORE OPERATION

## ARE YOU READY TO GET UNDER WAY ?

Your safety is your responsibility. A little time spent in preparation will significantly reduce your risk of injury.

### Knowledge

Read and understand this manual. Know what the controls do and how to operate them.

Familiarize yourself with the outboard motor and its operation before you get under way. Know what to do in case of emergencies.

Familiarize yourself with all laws and regulations relating to boating and the use of outboard motors.

### Safety

Always wear a PFD (Personal Flotation Device) while on the boat.

Attach the emergency stop switch lanyard securely to your PFD or to your wrist.

## IS YOUR OUTBOARD MOTOR READY TO GO ?

For your safety, and to maximize the service life of your equipment, it is very important to take a few moments before you operate the outboard motor to check its condition. Be sure to take care of any problem you find, or have your authorized Honda Marine dealer correct it, before you operate the outboard motor.

## WARNING

Improperly maintaining this outboard motor, or failing to correct a problem before operation, could cause a malfunction in which you could be seriously injured.

Always perform a preoperation inspection before each operation, and correct any problem.

Before beginning your preoperation checks, be sure the ignition switch is in the OFF position.

### Safety Inspection

- Look around the outboard motor for signs of oil or gasoline leaks.
- Check that the fuel hose is undamaged and properly connected.
- Wipe up any spills before starting the engine.
- Check the stern bracket to be sure the outboard motor is securely installed.
- Check that all controls are operating properly.
- Replace any damaged parts.
- Check that all fasteners are in place and securely tightened.

### Maintenance Inspection

- Check the engine oil level (p. 60 ). Running the engine with a low oil level can cause engine damage.
- Check to be sure the propeller is undamaged, and the castle nut is secured with the cotter pin (p. 74 ).
- Check that the anodes are securely attached to the gear case (p. 73 ) and are not excessively worn. The anodes help to protect the outboard motor from corrosion.
- Make sure the tool kit is onboard (p. 54 ). Replace any missing items.
- Check the fuel level in the fuel tank (p. 67 ).
- Check that the battery fluid is between the upper and lower levels, and the battery leads are connected securely.

- Check the water separator for water contamination (p. 71 ).

# OPERATION

## SAFE OPERATING PRECAUTIONS

To safely realize the full potential of this outboard motor, you need a complete understanding of its operation and a certain amount of practice with its controls.

Before operating the outboard motor for the first time, please review the *IMPORTANT SAFETY INFORMATION* on page 7 and the chapter titled *BEFORE OPERATION*.

For your safety, avoid starting or operating the engine in an enclosed area. Your engine's exhaust contains poisonous carbon monoxide gas which can collect rapidly in an enclosed area and cause illness or death.

## BREAK-IN PROCEDURE

### Break-in period: 10 hours

Proper break-in operation allows the moving parts to wear in smoothly for best performance and long service life.

#### First 15 minutes:

Run the engine at trolling speed. Use the minimum throttle opening necessary to operate the boat at a safe trolling speed.

#### Next 45 minutes:

Run the engine up to a maximum of 2,000 to 3,000 rpm, which is about 10% to 30% of maximum throttle opening.

#### Next 60 minutes:

Run the engine up to a maximum of 4,000 to 5,000 rpm, which is about 50% to 80% of maximum throttle opening.

Short full-throttle bursts are OK, but do not operate the engine continuously at full throttle.

For boats that plane easily, bring the boat up on plane, and then reduce the throttle opening to the recommended rpm range.

#### Next 8 hours:

Do not run the engine at full throttle for more than 5 minutes at a time.

## FUEL PRIMING

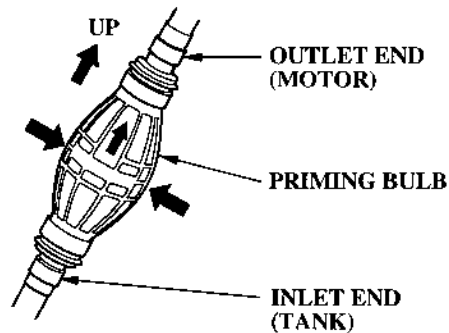

Hold the priming bulb up in the direction of the arrow, then squeeze the priming bulb several times until it feels firm, indicating that fuel has reached the engine.

Check to be sure there are no fuel leaks before starting the engine.

Do not squeeze the priming bulb when the engine is running.

## ⚠ WARNING

Gasoline is highly flammable and explosive.

You can be burned or seriously injured when handling fuel.

- Stop the engine and keep heat, sparks, and flame away.
- Handle fuel only outdoors.
- Wipe up spills immediately.

# OPERATION

## STARTING THE ENGINE

### Side-Mount Type

**EMERGENCY  
STOP SWITCH**

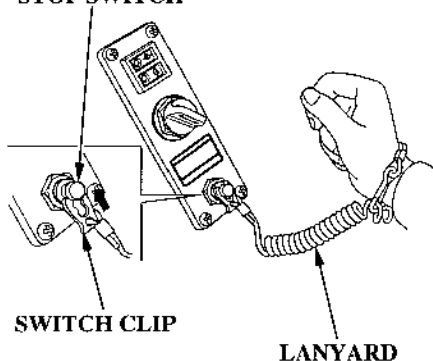

1. Put the emergency stop switch clip in the emergency stop switch, and attach the lanyard to your PFD (Personal Flotation Device) or to your wrist, as shown.

The engine will not start or run, unless the clip is in the switch.

The emergency stop switch clip and lanyard system is a safety device that will stop the engine if you fall away from the controls while operating the boat.

Always attach the lanyard to your PFD, or to your wrist, before starting the engine.

**N (neutral)**

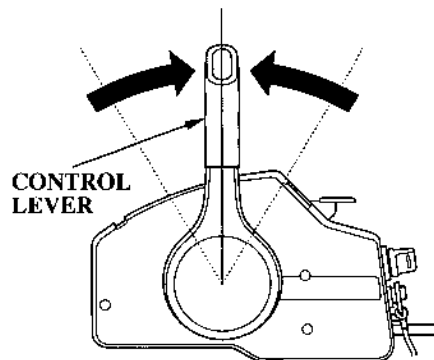

2. Set the control lever in the N (neutral) position.

The engine will not start if the F (forward) or R (reverse) gears are engaged.

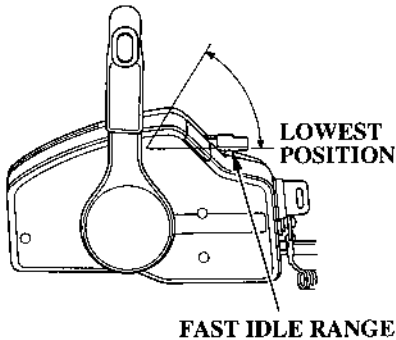

3. Leave the fast idle lever in the OFF (fully lowered) position.

Fast idle lever cannot be raised unless the control lever is in the N (neutral) position.

The control lever cannot be moved away from the N (neutral) position unless the fast idle lever is lowered.

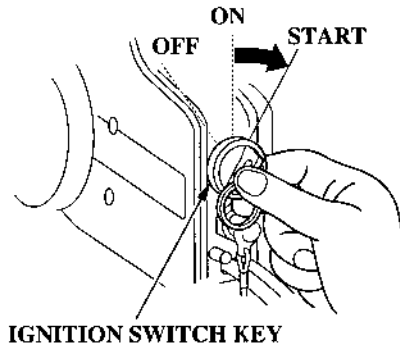

4. Turn the ignition switch key to the START position and hold it there until the engine starts.

When the engine starts, release the key, allowing it to return to the ON position.

If the engine fails to start within 5 seconds, release the key and wait at least 10 seconds before operating the starter again.

## NOTICE

- Using the electric starter for more than 5 seconds at a time will overheat the starter motor and can damage it.
- Turning the ignition switch key to the START position while the engine is running can damage the starter motor and flywheel.

## OPERATION

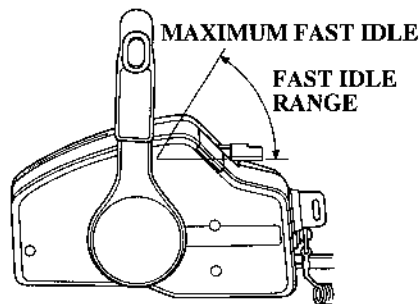

5. Before getting under way, allow the engine to warm up sufficiently to ensure good performance.

Above 41°F (5°C), warm up the engine for 2 or 3 minutes.

Below 41°F (5°C), warm up the engine for at least 10 minutes at 2,000 rpm. Raise the fast idle lever to achieve approximately 2,000 rpm.

During the warm-up period, check the oil pressure indicator (p. 29), overheating indicator (p. 29), and cooling system indicator (p. 30).

If the indicators show any abnormal condition, immediately stop the engine and determine the cause of the problem. Refer to *TAKING CARE OF UNEXPECTED PROBLEMS*, p. 82.

6. If the fast idle lever was used to warm up the engine, gradually lower the lever as the engine warms up.

When the fast idle lever is fully lowered, the control lever can be moved away from the N (neutral) position.



## Panel-Mount Type

### EMERGENCY STOP SWITCH

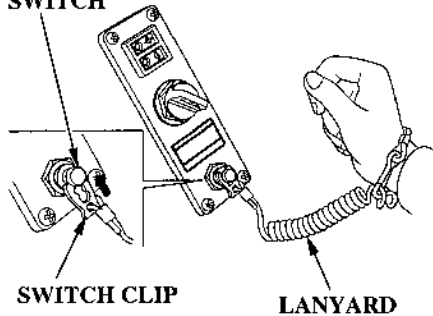

1. Put the emergency stop switch clip in the emergency stop switch, and attach the lanyard to your PFD (Personal Flotation Device) or to your wrist, as shown.

The engine will not start or run, unless the clip is in the switch.

The emergency stop switch clip and lanyard system is a safety device that will stop the engine if you fall away from the controls while operating the boat.

Always attach the lanyard to your PFD, or to your wrist, before starting the engine.

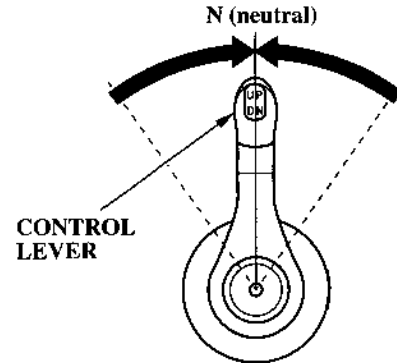

2. Set the control lever in the N (neutral) position.

The engine will not start if the F (forward) or R (reverse) gears are engaged.

## OPERATION

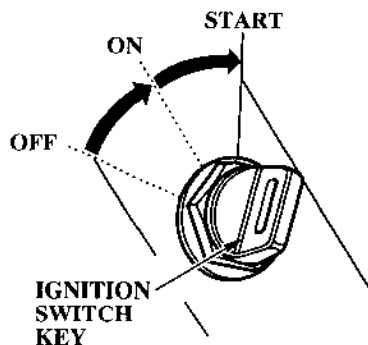

3. Turn the ignition switch key to the START position and hold it there until the engine starts.

When the engine starts, release the key, allowing it to return to the ON position.

If the engine fails to start within 5 seconds, release the key and wait at least 10 seconds before operating the starter again.

### NOTICE

- Using the electric starter for more than 5 seconds at a time will overheat the starter motor and can damage it.
- Turning the ignition switch key to the START position while the engine is running can damage the starter motor and flywheel.

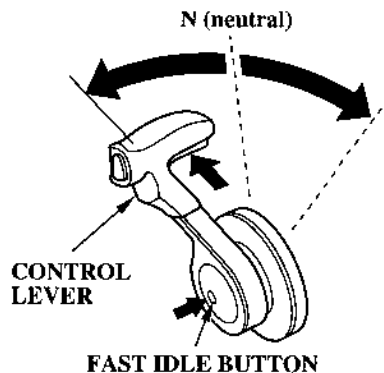

4. Before getting under way, allow the engine to warm up sufficiently to ensure good performance.

Above 41°F (5°C), warm up the engine for 2 or 3 minutes.

Below 41°F (5°C), warm up the engine for at least 10 minutes at 2,000 rpm. Push the fast idle lever forward then move the control lever to open the throttle and achieve approximately 2,000 rpm.

During the warm-up period, check the oil pressure indicator (p. 29), overheating indicator (p. 29), and cooling system indicator (p. 30).

If the indicators show any abnormal condition, immediately stop the engine and determine the cause of the problem. Refer to *TAKING CARE OF UNEXPECTED PROBLEMS*, p. 82.

5. If the fast idle control was used to warm up the engine, gradually return the control lever to the N (neutral) position as the engine warms up.

### Top-Mount Type

#### EMERGENCY STOP SWITCH

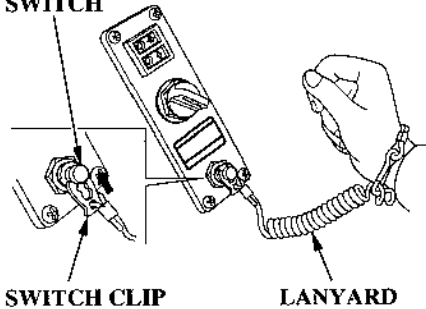

1. Put the switch clip in the emergency stop switch, and attach the lanyard to your PFD (Personal Flotation Device) or to your wrist, as shown.

The engine will not start or run, unless the clip is in the switch.

The emergency stop switch clip and lanyard system is a safety device that will stop the engine if you fall away from the controls while operating the boat.

Always attach the lanyard to your PFD, or to your wrist, before starting the engine.

## OPERATION

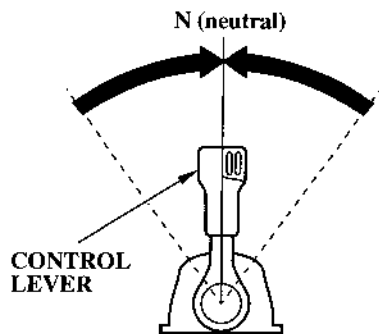

2. Set the control lever in the N (neutral) position.

The engine will not start if the F (forward) or R (reverse) gears are engaged.

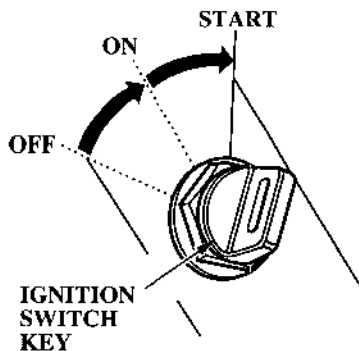

3. Turn the ignition switch key to the START position and hold it there until the engine starts.

When the engine starts, release the key, allowing it to return to the ON position.

If the engine fails to start within 5 seconds, release the key and wait at least 10 seconds before operating the starter again.

### NOTICE

- Using the electric starter for more than 5 seconds at a time will overheat the starter motor and can damage it.
- Turning the ignition switch key to the START position while the engine is running can damage the starter motor and flywheel.

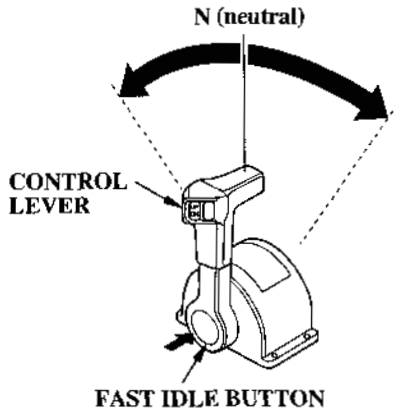

4. Before getting under way, allow the engine to warm up sufficiently to ensure good performance.

Above 41°F (5°C), warm up the engine for 2 or 3 minutes.

Below 41°F (5°C), warm up the engine for at least 10 minutes at 2,000 rpm. Push the fast idle button then move the control lever forward or reverse to open the throttle and achieve approximately 2,000 rpm.

During the warm-up period, check the oil pressure indicator (p. 29), overheating indicator (p. 29), and cooling system indicator (p. 30).

If the indicators show any abnormal condition, immediately stop the engine and determine the cause of the problem. Refer to *TAKING CARE OF UNEXPECTED PROBLEMS*, p. 82.

5. If the fast idle control was used to warm up the engine, gradually return the control lever to the N (neutral) position as the engine warms up.

## STOPPING THE ENGINE

### Emergency Engine Stopping

#### Side-Mount Type

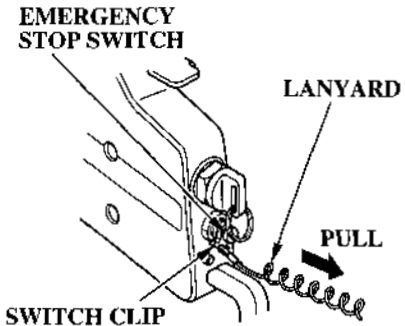

#### Panel-Mount/Top-Mount Types

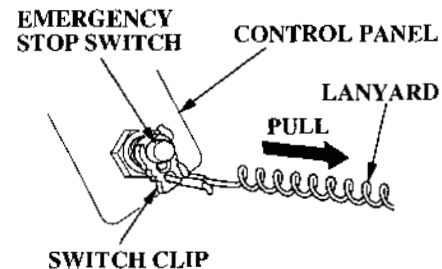

## OPERATION

To stop the engine in an emergency, pull the clip out of the emergency stop switch by pulling the lanyard.

We suggest that you stop the engine this way occasionally to verify that the engine and emergency stop switch is operating properly.

### Normal Engine Stopping

#### Side-Mount Type

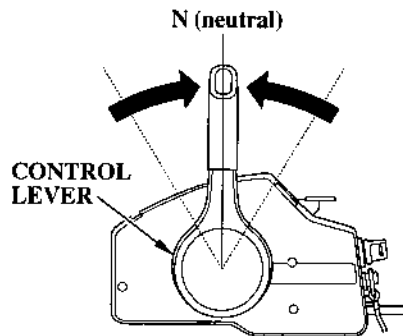

#### Panel-Mount Type

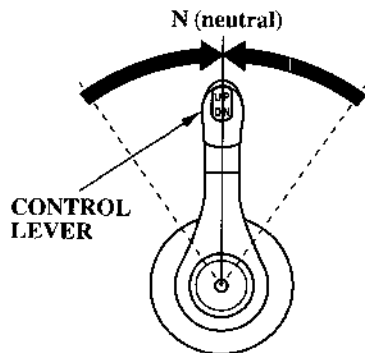

#### Top-Mount Type

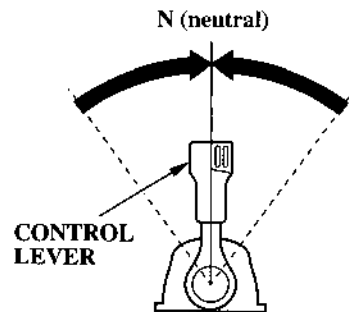

1. Move the control lever(s) to the N (neutral) position.

## Side-Mount Type

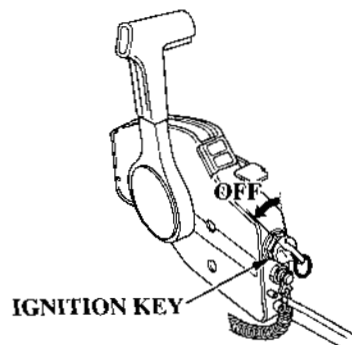

## Panel-Mount/Top-Mount Types

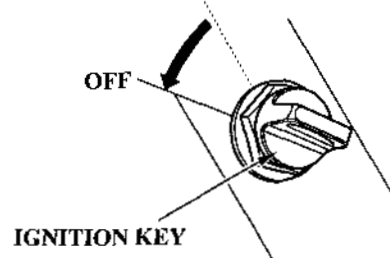

2. Turn the ignition switch key to the OFF position.

3. When the boat is not in use, remove and store the ignition key and the emergency stop switch clip and lanyard.

## GEARSHIFTING AND THROTTLE OPERATION

### Side-Mount Type

CONTROL LEVER



N (neutral)

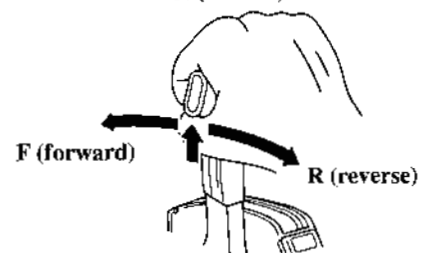

# OPERATION

## *Panel-Mount Type*

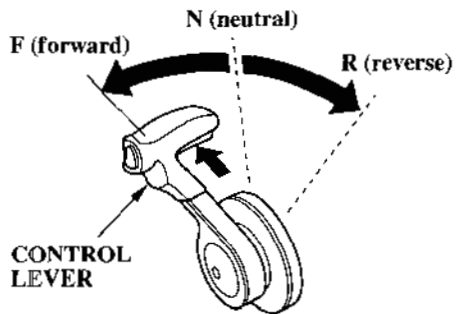

## *Top-Mount Type*

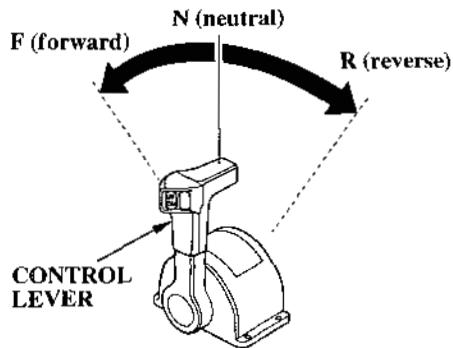

To shift gears, move the control lever to select F (forward), N (neutral) and R (reverse) gears.

The control lever cannot be moved from the N (neutral) position unless the neutral release lever is squeezed (side-mount/panel-mount types).

Moving the control lever beyond the gear selection range increases engine speed.

## *Side-Mount Type*

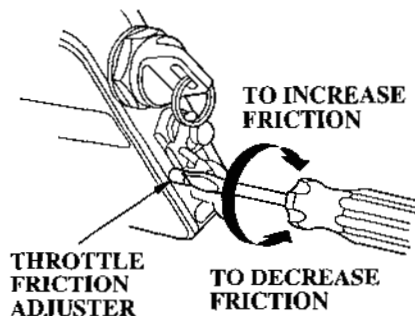

## *Panel-Mount Type*

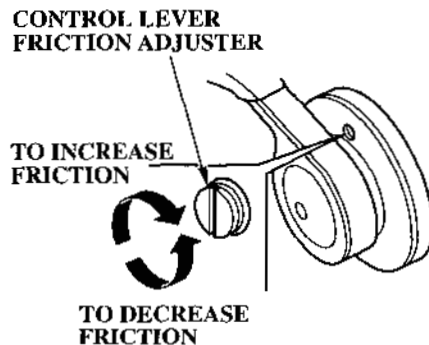



## *Top-Mount Type*

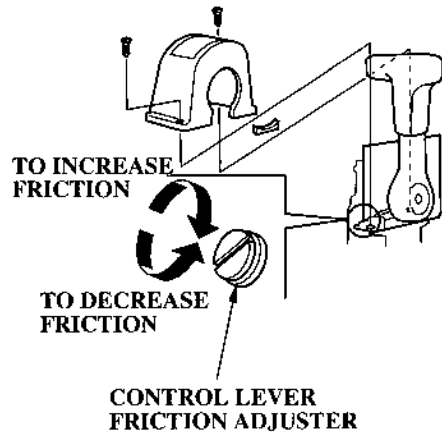

Adjust the throttle friction adjuster so the control lever will hold a constant throttle setting while cruising.

## **STEERING**

Steer the boat in the same manner as an automobile.

# OPERATION

---

## CRUISING

### Engine Speed

For best fuel economy, limit the throttle opening to 80%. Use the throttle friction control (p. 46) to help you hold a steady speed.

For rough water conditions or large waves, slow down to prevent the propeller from rising out of the water.

The engine is equipped with an overrev limiter to prevent the possibility of mechanical damage from excessive engine speed.

If, for example, the outboard motor is tilted excessively, or ventilation occurs during a sharp turn, the engine may overrev, activating the overrev limiter.

If engine speed becomes unstable at high speed due to activation of the overrev limiter, reduce speed and check the trim angle of the outboard

motor.

### Trim

Use the power trim/tilt switch to trim the outboard motor for the best performance and stability.

You can use the power trim/tilt switch at any time, whether the boat is under way or stopped.

Press the UP or DN (down) side of the switch to adjust the angle of the outboard motor.

Refer to the trim meter (p. 27) for an indication of whether the boat is trimmed high or low.

It is necessary to trim the angle of the outboard motor to compensate for changes in boat load, weight distribution, water conditions, or propeller selection.

Under normal conditions, the boat will perform best when the

antiventilation plate is level with the water.

When cruising into a high wind, trim the outboard motor down slightly to level the boat and improve stability. With a tail wind, trim the outboard motor up slightly.

#### NOTICE

*Excessive trim/tilt angle during operation can cause propeller ventilation, overheating, and water pump damage.*

## Side-Mount Type

POWER TRIM/TILT SWITCH

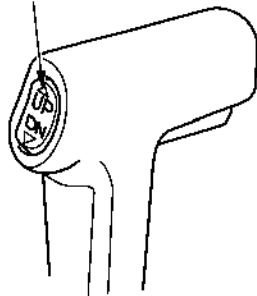

## Panel-Mount Type

POWER TRIM/TILT SWITCH

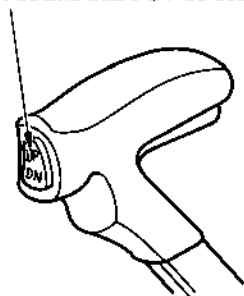

## Top-Mount Type

(single type)

POWER TRIM/TILT SWITCH

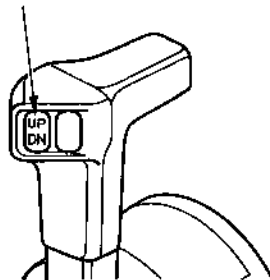

(dual type)

POWER TRIM/TILT SWITCH  
(LEFT) (RIGHT)

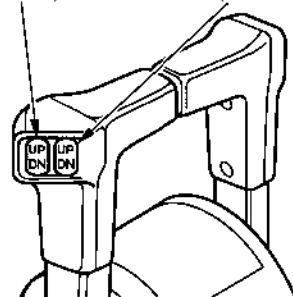

MOTOR  
TRIMMED TOO  
LOW

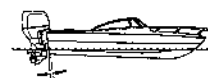

MOTOR  
TRIMMED TOO  
HIGH



MOTOR TRIMMED  
CORRECTLY



BOW TOO LOW DUE TO  
1. LOAD IN THE FRONT  
2. MOTOR TRIMMED TOO LOW

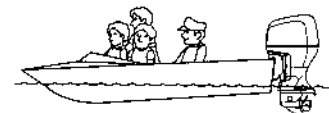

BOW TOO HIGH DUE TO  
1. LOAD IN THE REAR  
2. MOTOR TRIMMED TOO HIGH

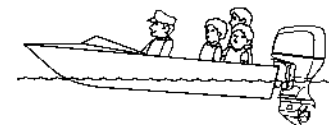

## OPERATION

If steering effort is not equal in both directions, adjust the trim tab to compensate for "torque steer," which is the reaction of the outboard motor to propeller rotation.

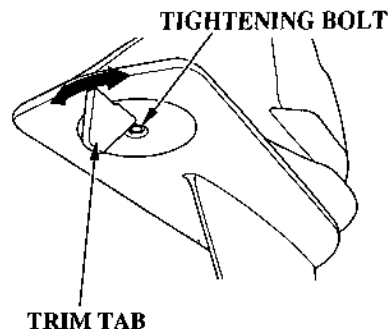

Adjust the trim tab with the engine stopped. Loosen the bolt above the trim tab, turn the trim tab, then tighten the bolt securely.

When the trim tab is correctly adjusted, steering effort will be equal in both directions.

## SHALLOW WATER OPERATION

When operating in shallow water, use the power trim/tilt switch (p. 49) to tilt the outboard motor, so the propeller and gear case won't hit the bottom.

Proceed at low speed, and monitor water flow from the cooling system indicator (p. 30) to be sure the outboard motor is not tilted so high that the water intakes are out of the water.

### NOTICE

*An excessive trim/tilt angle during operation can cause propeller ventilation, overheating, and water pump damage. This type of damage is not covered by the Distributor's Limited Warranty.*

## MOORING, BEACHING, LAUNCHING

To raise the outboard motor out of the water while the engine is stopped and the boat is moored, or for maximum clearance when beaching or launching, use the power tilt switch on the engine pan to tilt the outboard motor as far as it will go, move the tilt lock lever to the LOCK position, then gently lower the outboard motor until the lever contacts the stern bracket.

If more clearance is needed to swing the tilt lock lever into the LOCK position, rock the outboard motor back slightly by pulling on the engine cover grip.

To lower the outboard motor, tilt up, move the tilt lock lever to the FREE position, then lower the outboard motor to the desired position.

### POWER TILT SWITCH

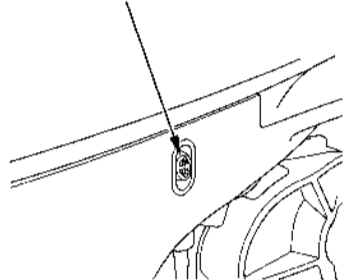

### TILT LOCK LEVER (Lock position)

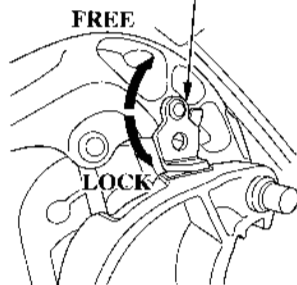

### NOTICE

*Do not attempt to use the power tilt switch to tilt the outboard motor down while the tilt lock lever is in the lock position. Damage to the power tilt system may occur.*

### MANUAL RELIEF VALVE

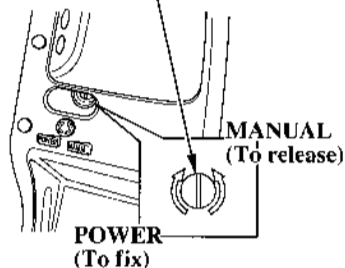

The outboard motor can also be tilted manually after opening the manual relief valve. This feature enables the outboard motor to be tilted or lowered when no battery is connected.

For manual tilting, use a screwdriver to turn the valve counterclockwise 1 or 2 turns. Close the valve firmly after positioning the engine.

Be sure the valve is closed before operating the outboard motor. If the valve is not closed, the outboard motor will tilt up when operated in reverse.

# SERVICING YOUR OUTBOARD MOTOR

## THE IMPORTANCE OF MAINTENANCE

Good maintenance is essential for safe, economical, and trouble-free operation. It will also help reduce air pollution.

### **▲ WARNING**

Improperly maintaining this outboard motor, or failure to correct a problem before operation, can cause a malfunction in which you could be seriously hurt or killed.

Always follow the inspection and maintenance recommendations and schedules in this owner's manual.

To help you properly care for your outboard motor, the following pages include a maintenance schedule, routine inspection procedures, and simple maintenance procedures using basic hand tools. Other service tasks that are more difficult, or require special tools, are best handled by professionals and are normally performed by a Honda technician or other qualified mechanic.

The maintenance schedule applies to normal operating conditions. If you operate your outboard motor under unusual conditions, consult an authorized Honda marine dealer for recommendations applicable to your individual needs and use.

Remember that your authorized Honda marine dealer knows your outboard motor best and is fully equipped to maintain and repair it.

To ensure the best quality and reliability, use only new, genuine Honda parts or their equivalents for repair and replacement.

**Maintenance, replacement, or repair of the emission control devices and systems may be performed by any marine engine repair establishment or individual, using parts that are "certified" to EPA standards.**

### MAINTENANCE SAFETY

Some of the most important safety precautions follow. However, we cannot warn you of every conceivable hazard that can arise in performing maintenance. Only you can decide whether or not you should perform a given task.

#### **▲ WARNING**

Failure to properly follow maintenance instructions and precautions can cause you to be seriously hurt or killed.

Always follow the procedures and precautions in the owner's manual.

### Safety Precautions

- Make sure the engine is off before you begin any maintenance or repairs. This will eliminate several potential hazards:
  - **Carbon monoxide poisoning from engine exhaust.**  
Be sure there is adequate ventilation whenever you operate the engine.
  - **Burns from hot parts.**  
Let the engine and exhaust system cool before touching.
  - **Injury from moving parts.**  
Do not run the engine unless instructed to do so.
- Read the instructions before you begin, and make sure you have the tools and skills required.
- To reduce the possibility of fire or explosion, be careful when working around gasoline. Use only a nonflammable solvent, not gasoline, to clean parts. Keep cigarettes, sparks, and flames away from all fuel-related parts.
- Wear gloves when handling the propeller to protect your hands from sharp edges.

# SERVICING YOUR OUTBOARD MOTOR

## TOOL KIT (optional equipment)

The following tools are supplied by your dealer for simple maintenance procedures and emergency repairs. Keep these items on the boat, so they will always be available if you need them.

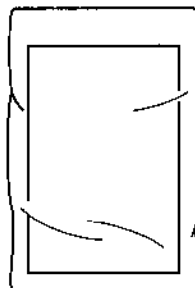

OWNER'S MANUAL



SPARE SWITCH CLIP  
(R2, R3 type only)



14 × 17 mm WRENCH



10 × 12 mm WRENCH



8 mm WRENCH

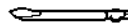

OIL CHECK  
SCREWDRIVER



FLAT SCREWDRIVER



PHILLIPS  
SCREWDRIVER

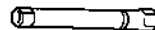

SPARK PLUG WRENCH

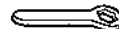

19 mm EYE WRENCH



16 × 17 mm BOX WRENCH



FUSE PULLER



SCREWDRIVER HANDLE



TOOL BAG



PLIERS



6 mm HEX. WRENCH



# SERVICING YOUR OUTBOARD MOTOR

## MAINTENANCE SCHEDULE

REGULAR SERVICE PERIOD(3) Perform at every indicated month or operating hour interval, whichever comes first.		Each use	After use	First month or 20 hrs.	Every 6 months or 100 hrs.	Every year or 200 hrs.	Every 2 years or 400 hrs.
ITEM							
● Engine oil	Check level	○					
	Change			○	○		
Gear case oil	Change			○ (2)	○ (2)		
● Engine oil filter	Replace					○ (2)	
Timing belt	Check-adjust					○ (2)	
ACG belt	Check-adjust					○ (2)	
Throttle linkage	Check-adjust			○ (2)	○ (2)		
● Idling speed	Check-adjust			○ (2)	○ (2)		
● Valve clearance	Check-adjust			○ (2)		○ (2)	
● Spark plug	Check			○		○	
	Clean			○ (2)		○ (2)	
	Replace						○
Propeller and Cotter pin	Check	○					
Anode	Check	○					
Lubrication	Grease			○ (1)	○ (1)		
● Water separator	Check	○					

● Emission related items.

- (1) Lubricate more frequently when used in salt water.
- (2) These items should be serviced by an authorized Honda marine dealer, unless you have the proper tools and are mechanically proficient. Refer to the Honda shop manual for service procedures.
- (3) For professional commercial use, log hours of operation to determine proper maintenance intervals.
- (4) When operating in salt water, turbid or muddy water, the engine should be flushed with clean water after each use.

## SERVICING YOUR OUTBOARD MOTOR

REGULAR SERVICE PERIOD (3) Perform at every indicated month or operating hour interval, whichever comes first.		Each use	After use	First month or 20 hrs.	Every 6 months or 100 hrs.	Every year or 200 hrs.	Every 2 years or 400 hrs.
ITEM							
• Fuel filter	Check Replace				○		○
• Fuel filter (High pressure type)	Replace						○ (2)
Thermostat	Check					○ (2)	
• Fuel line	Check Replace	○		Every 2 years (if necessary) (2)			
Battery and cable connection	Check level-tightness	○					
Bolts and Nuts	Check-tightness			○ (2)	○ (2)		
• Crankcase breather tube	Check					○ (2)	
Cooling water passages	Clean		○ (4)				

● Emission related items.

- (1) Lubricate more frequently when used in salt water.
- (2) These items should be serviced by an authorized Honda marine dealer, unless you have the proper tools and are mechanically proficient. Refer to the Honda shop manual for service procedures.
- (3) For professional commercial use, log hours of operation to determine proper maintenance intervals.
- (4) When operating in salt water, turbid or muddy water, the engine should be flushed with clean water after each use.

## TRIM TAB ADJUSTMENT

The trim tab compensates for "torque steer" which is a reaction of the outboard motor to propeller rotation.

If uncompensated, torque steer would make the outboard motor tend to turn to one side.

When the trim tab is correctly adjusted, steering effort is equal in either direction.

If steering effort is unequal, loosen the trim tab bolt and adjust the angle of the trim tab. Retighten the trim tab bolt securely.

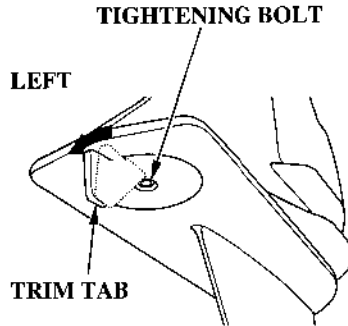

If less effort is required to make left turns, move the back of the trim tab left.

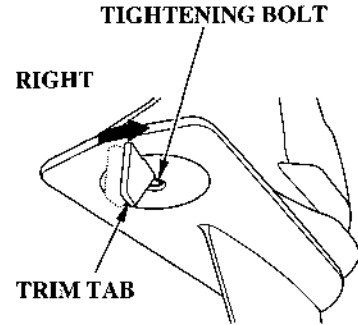

If less effort is required to make right turns, move the back of the trim tab right.

Adjust the trim tab in small increments, and retest steering effort with the boat evenly loaded and running at cruising speed.

# SERVICING YOUR OUTBOARD MOTOR

## MANUAL RELIEF VALVE

### MANUAL RELIEF VALVE

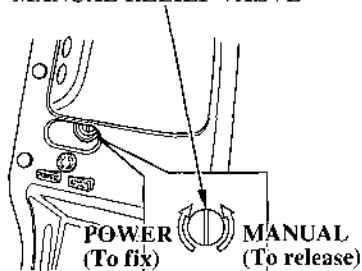

The outboard motor can be tilted manually after opening the manual relief valve. This feature enables the outboard motor to be tilted or lowered when no battery is connected.

For manual tilting, use a screwdriver to turn the valve counterclockwise 1 or 2 turns. Close the valve firmly after positioning the outboard motor.

Be sure the valve is closed before operating the outboard motor. If the valve is not closed, the outboard motor will tilt up when operated in reverse.

## ENGINE COVER REMOVAL AND INSTALLATION

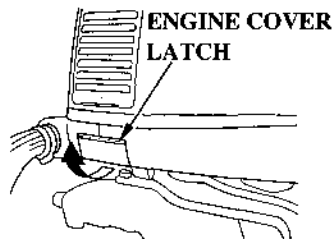

To remove the engine cover, pull the engine cover latch to the unlocked position, then lift the engine cover straight up from the outboard motor.

To install the engine cover, place the cover on the outboard motor, and push down evenly.

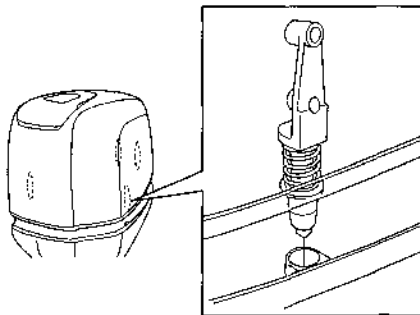

The engine cover latch fastens the engine cover to the outboard motor.

## Latch Adjustment

A loose engine cover may rattle or allow water to enter. Check whether the engine cover fits properly and adjust if necessary.

## Engine Cover Clearance Inspection

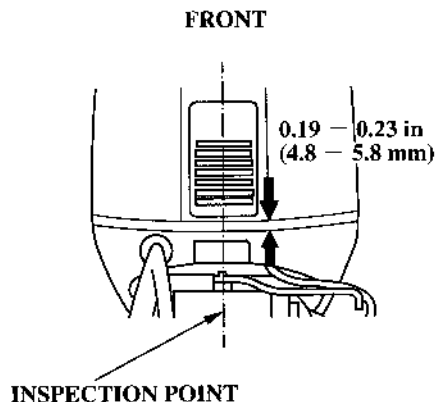

## REAR

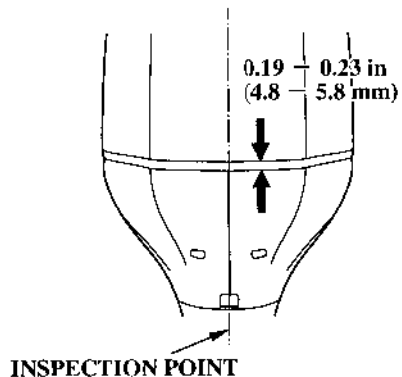

With the engine cover in place, measure the clearance between the engine cover and the engine undercase at the latch.

Specified engine cover clearance:  
0.19 - 0.23 in (4.8 - 5.8 mm)

If the clearance is outside the specified range, adjust the cover lock bolt.

## Cover Lock Bolt Adjustment

1. Remove the engine cover.

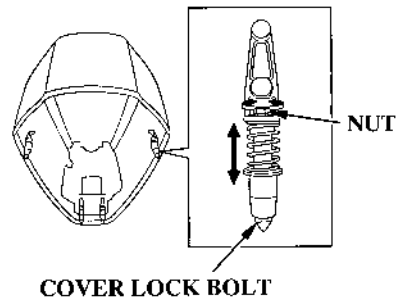

2. Loosen or tighten the nuts on the front and/or side cover lock bolts, and move the bolt (s) as necessary to obtain the specified engine cover clearance.
3. After adjustment, install the engine cover securely.
4. Recheck the engine cover clearance, and readjust if necessary.

# SERVICING YOUR OUTBOARD MOTOR

## Engine Oil Level Check

Check the engine oil level with the engine stopped and the outboard motor in the vertical position.

1. Unlock and remove the engine cover (p. 58).
2. Remove the dipstick and wipe it clean.

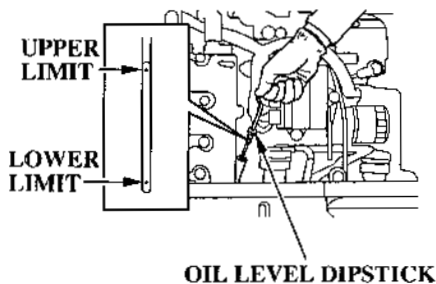

3. Insert the dipstick all the way in, then remove it and check the oil level shown on the dipstick.

## OIL FILLER CAP

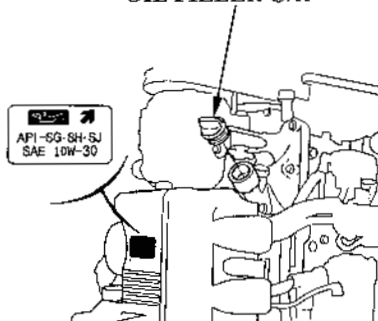

4. If the oil level is low, remove the oil filler cap, and add oil to reach the upper limit mark shown on the dipstick. Use the oil recommended on p. 62.

### NOTICE

*Running the engine with a low oil level can cause engine damage.*

5. Install the oil filler cap and tighten it securely. Do not overtighten.
6. Install and lock the engine cover.

## Engine Oil Change

An engine oil evacuation/filling device may be used to remove/add the engine oil.

Drain the used oil while the engine is warm. Warm oil drains quickly and completely.

1. Unlock and remove the engine cover (p. 58).

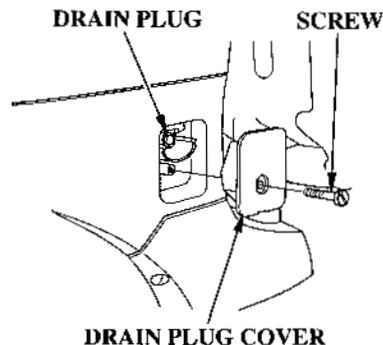

2. Remove the screw from the oil drain plug cover, and remove the cover.

## SERVICING YOUR OUTBOARD MOTOR

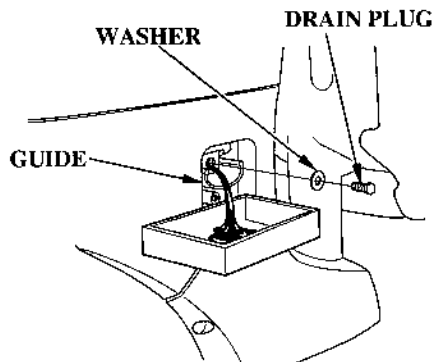

3. Place a suitable container below the oil drain guide to catch the used oil, then remove the oil filler cap and the drain plug.
4. Allow the used oil to drain completely, then reinstall the engine oil drain plug, and tighten it securely.

### NOTICE

*Improper disposal of engine oil can be harmful to the environment. If you change your own oil, please dispose of the used oil properly. Put it in a sealed container, and take it to a recycling center. Do not discard it in a trash bin or dump it on the ground.*

5. Install the oil drain plug cover and secure it with the screw.
6. With the outboard motor in a vertical position, fill to the upper limit mark on the dipstick (p. 60) with the recommended oil.  
Engine oil refill capacity:  
Without oil filter change:  
8.0 US qt (7.6 l , 6.7 Imp qt)
7. Install the oil filler cap and tighten it securely.
8. Install and lock the engine cover.

# SERVICING YOUR OUTBOARD MOTOR

---

## Engine Oil Recommendations

Oil is a major factor affecting performance and service life. Use 4-stroke automotive detergent oil.

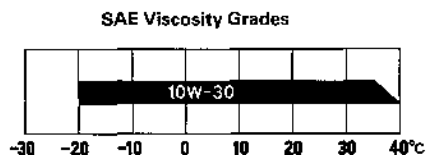

**AMBIENT TEMPERATURE**

SAE 10W-30 is recommended for general use.

The SAE oil viscosity and service classification are in the API label on the oil container. Honda recommends that you use API SERVICE category SG, SH or SJ oil with the "starburst" certification mark displayed on the container.



# SERVICING YOUR OUTBOARD MOTOR

## Lubrication Points

Wipe the outside of the engine with a cloth dipped in oil.  
Apply marine anticorrosion grease to the following parts:  
Lubrication interval:  
After the first 20 hours or 1 month, then every 100 hours or 6 months. (Refer to the maintenance schedule page 55).

### NOTICE

*Apply anticorrosion oil to pivot surfaces where grease cannot penetrate.*

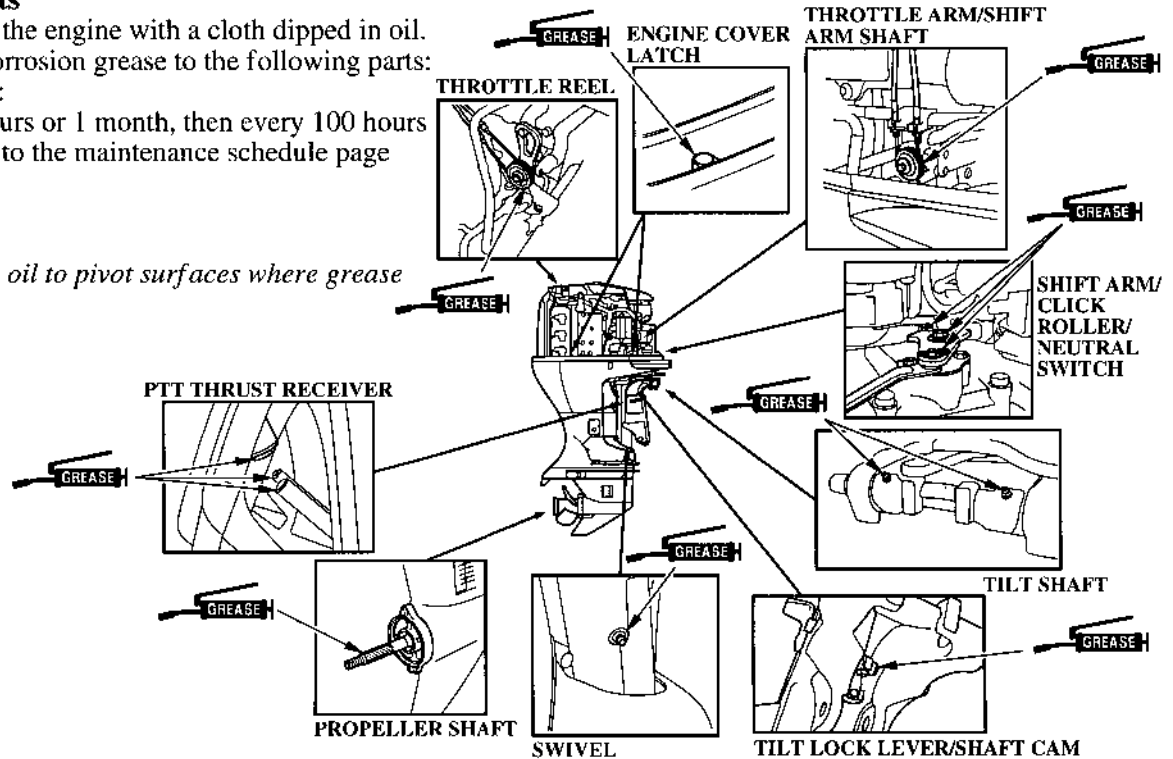

Apply Honda Marine Corrosion Inhibitor (or equivalent) to all areas under the engine cover except the belts.

# SERVICING YOUR OUTBOARD MOTOR

## Spark Plug Service

### RECOMMENDED SPARK PLUGS:

IZFR6F11 (NGK)

VKJ20RZ-M11 (DENSO)

#### NOTICE

*Incorrect spark plugs can cause engine damage.*

1. Disconnect the battery negative (—) terminal.
2. Unlock and remove the engine cover (p. 58).

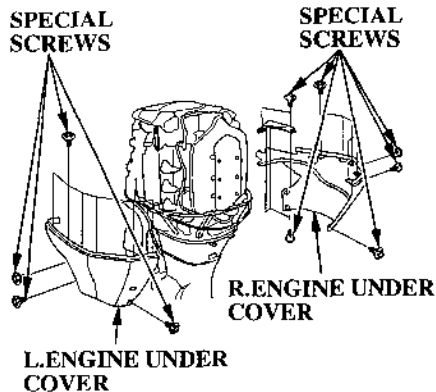

3. Remove the twenty special bolts, and remove the R. and L. engine under covers.

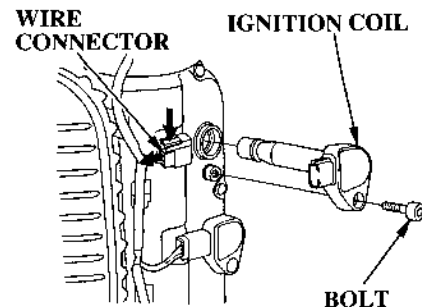

4. Disconnect the wire connector from the ignition coil by pushing on the lock tab and pulling on the connector. Pull on the plastic connector, not the wires.
5. Use a hex. wrench to remove the bolt holding the ignition coil. Remove the ignition coil by pulling it up slightly.

## SERVICING YOUR OUTBOARD MOTOR

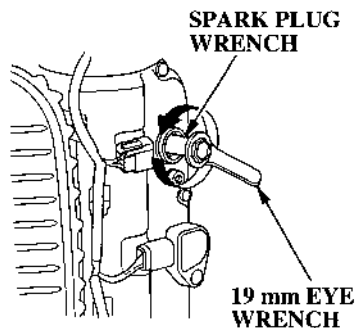

6. Remove the spark plugs with a spark plug wrench and 17 mm wrench.

0.039 – 0.051 in  
(1.00 – 1.30 mm)



7. Inspect the spark plugs. Replace them if the electrodes are worn, or if the insulators are cracked or chipped.
8. Measure the spark plug electrode gap with a suitable gauge. The gap should be 0.039 – 0.051 inches (1.00 – 1.30 mm). If the gap is out of the specification, replace the plug with a new one. Never try to readjust the gap.

9. Install the spark plugs carefully, by hand, to avoid cross-threading.

10. After each spark plug seats, tighten with a spark plug wrench supplied in the tool kit to compress the sealing washer.

If reinstalling the used spark plugs, tighten 1/8 - 1/4 turn after the spark plugs seat.

If reinstalling new spark plugs, tighten 1/2 turn after the spark plugs seat.

### NOTICE

*Loose spark plugs can overheat and damage the engine.  
Overtightening the spark plugs can damage the threads in the cylinder head.*

## SERVICING YOUR OUTBOARD MOTOR

---

11. Install the ignition coil. Reinstall the bolt.
12. Push the wire connector onto the ignition coil. Make sure it locks in place.
13. Repeat this procedure for the other five spark plugs.
14. Reinstall the covers. When reinstalling the covers, make sure not to jam the wire harnesses in between the covers and engine case.

### REFUELING

Check the fuel level and refill if necessary. Do not fill the fuel tank above the UPPER LIMIT. Refer to the boat manufacture's instructions.

#### **⚠ WARNING**

Gasoline is highly flammable and explosive.

You can be burned or seriously injured when handling fuel.

- Stop the engine and keep heat, sparks, and flame away.
- Handle fuel only outdoors.
- Wipe up spills immediately.

Never refill the fuel tank inside a building where gasoline fumes may reach flames or sparks. Keep gasoline away from appliance pilot lights, barbecues, electric appliances, power tools, etc.

Spilled fuel is not only a fire hazard, it causes environmental damage. Wipe up spills immediately.

# SERVICING YOUR OUTBOARD MOTOR

---

## FUEL RECOMMENDATIONS

**Use unleaded gasoline with a pump octane rating of 86 or higher.**

These outboard motors are certified to operate on unleaded gasoline. Unleaded gasoline produces fewer engine and spark plug deposits and extends exhaust system life.

Never use stale or contaminated gasoline or an oil/gasoline mixture. Avoid getting dirt or water in the fuel tank.

Occasionally you may hear a light “spark knock” or “pinging” (metallic rapping noise) while operating under heavy loads. This is no cause for concern.

If spark knock or pinging occurs at a steady engine speed, under normal load, change brands of gasoline. If spark knock or pinging persists, see an authorized Honda marine dealer.

### NOTICE

*Running the engine with persistent spark knock or pinging can cause engine damage.*

Running the engine with persistent spark knock or pinging is misuse, and the *Distributor's Limited Warranty* does not cover parts damaged by misuse.

### Fuel Pump Filter Inspection and Replacement

The fuel pump filter (inside the strainer cup) is located below the engine oil filter.

Water or sediment accumulated in the filter can cause loss of power or hard starting. To prevent engine malfunction, inspect the filter and replace when necessary.

#### **▲ WARNING**

Gasoline is highly flammable and explosive.

You can be burned or seriously injured when handling fuel.

- Stop the engine and keep heat, sparks, and flame away.
- Handle fuel only outdoors.
- Wipe up spills immediately.

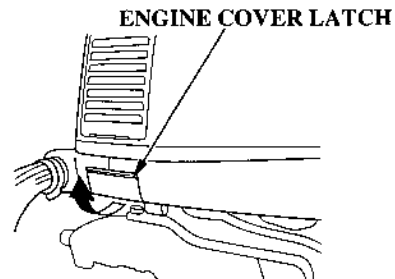

1. Remove the engine cover.

## SERVICING YOUR OUTBOARD MOTOR

**ENGINE OIL FILTER**

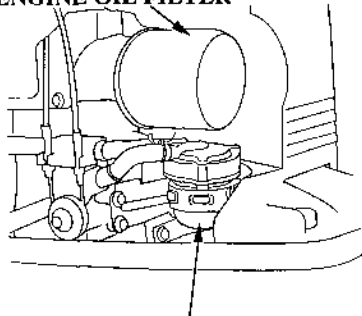

**FUEL FILTER (inside strainer cup)**

2. Looking through the translucent strainer cup, check the fuel filter for water accumulation or sediment.

**SCREW (3)**

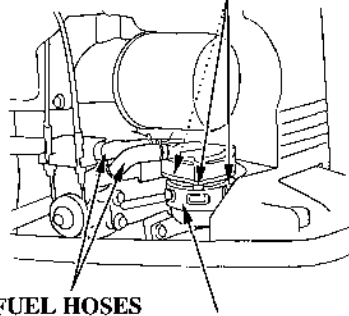

**FUEL HOSES**

**SUSPENSION STRAP**

3. Remove the suspension strap from the strainer bracket, then remove the strainer assembly from the strap.  
Before removing the fuel filter, to prevent fuel leakage, place fuel hose clamps on the fuel hoses at the each side of the fuel filter.

4. Remove the three screws and separate the fuel strainer cup from the strainer body.

5. Thoroughly clean the strainer cup, and replace with a new fuel filter.

6. Reassemble the strainer body and the cup.

### **STRAINER TIGHTENING**

#### **TORQUE:**

**3.4 N·m (0.35 kgf·m , 2.5 lbf·ft)**

7. Reinstall the strainer in the original position.



8. Prime the engine using the priming bulb (refer to page 35). Check for fuel leaks. Repair any fuel leaks if necessary.

If loss of power or hard starting are found to be caused by excessive water or sediment accumulation in the fuel filter, inspect the fuel tank.

Clean the fuel tank and tank filter if necessary. It may be necessary to drain the fuel tank completely and refill with fresh gasoline.

### Water Separator Inspection and Service

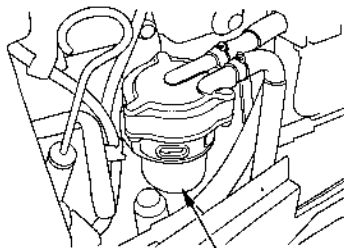

**WATER SEPARATOR**

Water separator is located beside the oil level dipstick. Water accumulation in the water separator can cause loss of power or hard starting. Check the water separator periodically. Clean it or consult with an authorized Honda outboard motor dealer for clean.

### **▲ WARNING**

Gasoline is highly flammable and explosive.

You can be burned or seriously injured when handling fuel.

- Stop the engine and keep heat, sparks, and flame away.
- Handle fuel only outdoors.
- Wipe up spills immediately.

## SERVICING YOUR OUTBOARD MOTOR

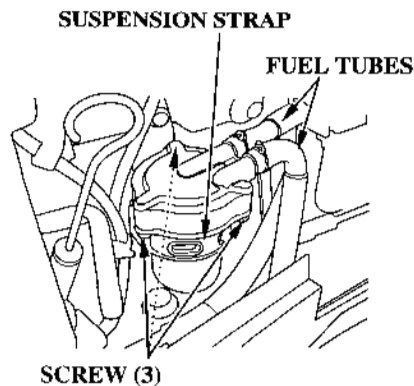

1. Remove the engine cover (see page 58).
2. Disconnect the water level sensor connector.
3. Remove the suspension strap from the water separator bracket, then remove the separator assembly from the strap.
4. Pinch the fuel tubes with tube clips to prevent fuel leakage.

5. Remove the three screws and separate the water separator cup from the body.
6. Thoroughly clean the water separator cup.
7. Reassemble the water separator body and the cup.  
**TIGHTENING TORQUE:**  
3.4 N·m (0.35 kgf·m , 2.5 lbf·ft)
8. Reinstall the strainer in the reverse order of removal.

9. Squeeze and release the priming bulb to fill the vapor separator, and check for leaks.

If the buzzer sounds or water or sediment accumulation are found to be caused by excessive water or sediment accumulation in the fuel filter, inspect the fuel tank.

Clean the fuel tank and tank filter if necessary. It may be necessary to drain the fuel tank completely and refill with fresh gasoline.

### Anode Replacement

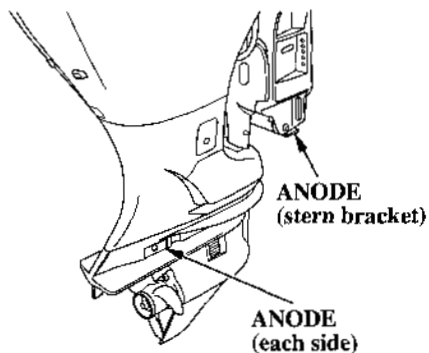

The anodes are located on each side of the gearcase. They are made of a sacrificial material that helps to protect the outboard motor from corrosion.

Replace the anodes when they have been reduced to about half their original size, or if they are crumbling.

#### NOTICE

*Painting or coating the anodes will defeat their purpose and will lead to rust and corrosion damage to the outboard motor. The anodes must be exposed to the water in order to protect the outboard motor.*

# SERVICING YOUR OUTBOARD MOTOR

## Propeller Replacement

Before replacing the propeller, remove the clip from the engine stop switch to prevent any possibility of the engine being started while you are working with the propeller.

The propeller blades may have sharp edges, so wear heavy gloves to protect your hands.

### Removal

1. Remove the cotter pin, unscrew the castle nut, remove the washer, then remove the propeller and thrust washer.
2. Inspect the propeller shaft for any fishing line or debris.

### Installation

1. Apply marine-grade grease to the propeller shaft and beveled surface of the thrust washer.
2. Install the propeller in the reverse order of removal.

#### NOTICE

- *Install the thrust washer with the grooved side toward the gear case.*
- *Use a genuine Honda cotter pin and bend the pin ends as shown.*

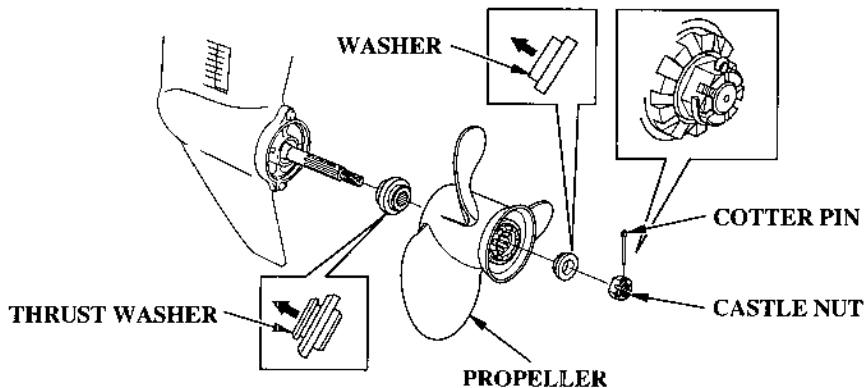

## STORAGE PREPARATION

Proper storage preparation is essential for keeping your outboard motor troublefree and looking good. The following steps will help to keep rust and corrosion from impairing your outboard motor's function and appearance, and will make the engine easier to start when you use the outboard motor again.

### Cleaning and Flushing

Thoroughly clean and flush the outboard motor with fresh water after operation in dirty water or salt water.

Touch up any damaged paint, and coat areas that may rust with a light film of oil. Lubricate controls with a silicone spray lubricant.

### *Cleaning*

Wash the outside of the outboard motor with clean, fresh water, and flush the cooling system as described on p. 30.

### *Flushing With the Honda Garden Hose Adapter (commercially available)*

When using the Honda garden hose adapter (commercially available), do not to run the engine during the flushing procedure.

For safety, remove the emergency stop switch clip so the engine cannot be started while you are standing near the propeller.

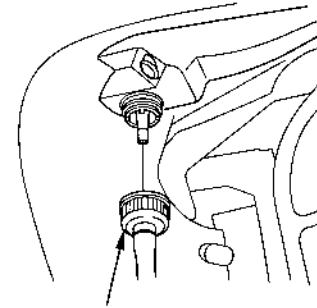

**FLUSH PULG  
CONNECTOR**

1. Remove the flush plug connector.

## STORAGE

---

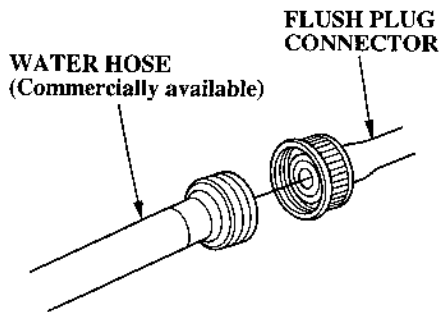

2. Screw the water hose into the flush plug connector.

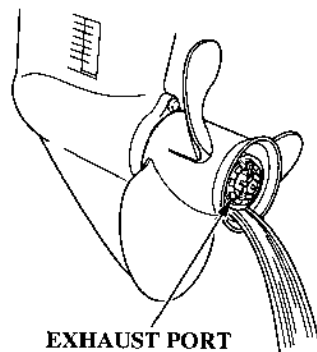

3. Turn on the fresh water supply and flush the outboard motor for at least 10 minutes.
4. After flushing, remove the garden hose adapter, and install the flush plug cap.

## Fuel

Gasoline will oxidize and deteriorate in storage. Old gasoline will cause hard starting, and it leaves gum deposits that clog the fuel system. If the gasoline in your fuel tank and vapor separator deteriorates during storage, you may need to have the vapor separator and other fuel system components serviced or replaced.

The length of time that gasoline can be left in your fuel tank and vapor separator without causing functional problems will vary with such factors as gasoline blend, your storage temperatures, and whether the fuel tank is partially or completely filled. The air in a partially filled fuel tank promotes fuel deterioration. Very warm storage temperatures accelerate fuel deterioration. Fuel deterioration problems may occur within a few months, or even less if the gasoline was not fresh when you filled the fuel tank.

The *Distributor's Limited Warranty* does not cover fuel system damage or engine performance problems resulting from neglected storage preparation.

You can avoid fuel deterioration problems by draining the fuel tank and vapor separator.

### VAPOR SEPARATOR

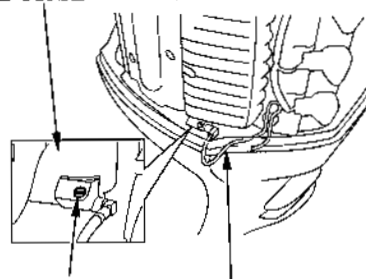

DRAIN BOLT

DRAIN HOSE

1. Unhook the drain hose from the lower left of the head cover.
2. Set the end of the hose toward the outside of the engine undercase.

3. Loosen the vapor separator drain bolt.

### **▲ WARNING**

Gasoline is highly flammable and explosive.

You can be burned or seriously injured when handling fuel.

- Stop the engine and keep heat, sparks, and flame away.
- Handle fuel only outdoors.
- Wipe up spills immediately.

## STORAGE

4. Tilt up the outboard motor.
5. Tilt down the outboard motor, and drain the vapor separator.
6. After draining thoroughly, tighten the drain bolt securely.
7. Clip the drain hose on the head cover.
8. Drain the fuel tank into an approved gasoline container, or if you need to store fuel in the fuel tank, you can extend fuel storage life by filling the fuel tank with fresh gasoline and adding a fuel stabilizer that is formulated for that purpose.

### Engine Oil

1. Change the engine oil (p. 60 — 61 ).
2. Remove the spark plugs (p. 64 ), and remove the clip from the emergency stop switch.
3. Pour a tablespoon (5 — 10 cm<sup>3</sup>) of clean engine oil into each cylinder.
4. Rotate the engine a few revolutions to distribute the oil in the cylinders.
5. Reinstall the spark plugs (p. 65 ).

### HOISTING THE OUTBOARD MOTOR

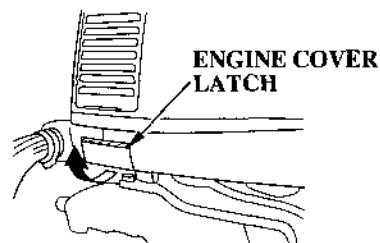

1. Unlock and remove the engine cover.



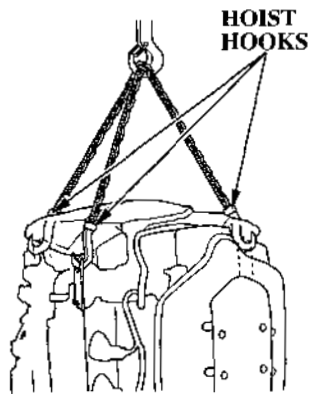

### STORAGE PRECAUTIONS

Select a well-ventilated storage area. If possible, avoid storage areas with high humidity.

If storing a container of gasoline, store it away from any appliance that operates with a flame, such as a furnace, water heater, or clothes dryer. Also avoid any area with a spark-producing electric motor, or where power tools are operated.

2. Attach the hoist hooks to the lifting eyes.
3. Disconnect the outboard motor from the boat, hoist the outboard motor, and move it to the storage area.
4. After the outboard motor is placed in storage and disconnected from the hoist, install the engine cover.

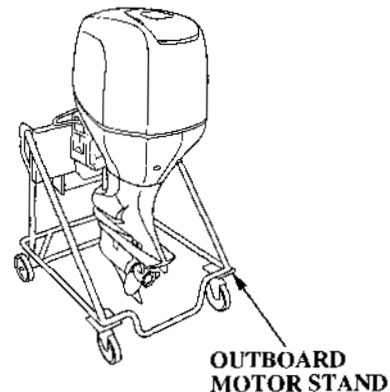

If the outboard motor will be removed from the boat for storage, we recommend storing it vertically by mounting it on a stand.

## STORAGE

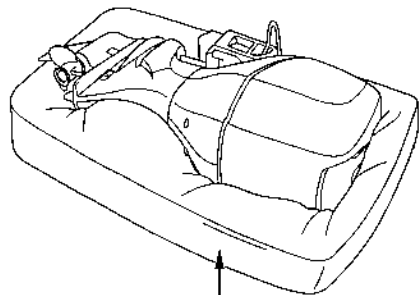

**PROTECTOR**

If it is necessary to store the outboard motor horizontally, drain the vapor separator (p. 77 ), and drain the engine oil (p. 60 ), before removing the outboard motor from the boat.

Rest the motor on and cushion of protective packing material.

Cover the outboard motor to keep out dust. Do not use sheet plastic as a dust cover. A nonporous cover will trap moisture, promoting rust and corrosion.

## REMOVAL FROM STORAGE

Check your outboard motor as described in the *BEFORE OPERATION* chapter of this manual.

If the cylinders were coated with oil during storage preparation, the engine may smoke briefly at startup. This is normal.

### WITH OUTBOARD MOTOR INSTALLED ON BOAT

When trailering a boat with the outboard motor attached, leave the engine in the normal running position, if possible.

Use a motor support bar to prevent the outboard motor from moving while trailering the boat. Refer to the manufacturer's instructions for using a motor support bar.

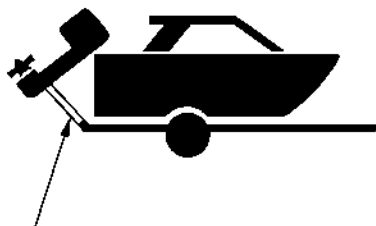

**MOTOR SUPPORT BAR**  
(commercially available)

### WITH OUTBOARD MOTOR REMOVED FROM BOAT

Secure the outboard motor in either the vertical or horizontal position shown on p. 79 — 80 .

## TAKING CARE OF UNEXPECTED PROBLEMS

ENGINE WILL NOT START	Possible Cause	Correction
1. Check emergency stop switch clip.	Clip not inserted in stop switch.	Insert clip in stop switch.
2. Check control positions.	Control lever not in neutral position.	Shift to neutral.
	Fast idle lever raised (side-mount type).	Leave fast idle lever OFF (p. 18).

## TAKING CARE OF UNEXPECTED PROBLEMS

ENGINE WILL NOT START (continued)	Possible Cause	Correction
3. Check fuel.	Out of fuel.	Refuel (p. 67).
	Fuel hose not primed.	Squeeze priming bulb (p. 31).
	Fuel pump filter or fuel tank filter clogged.	Replace fuel filters (p. 69).
	Bad fuel; boat stored without treating or draining gasoline, or refueled with bad gasoline.	Drain fuel tank and vapor separator (p. 77). Refill with fresh gasoline (p. 67).

## TAKING CARE OF UNEXPECTED PROBLEMS

ENGINE WILL NOT START (continued)	Possible Cause	Correction
4. Check battery.	Battery connections loose or corroded.	Clean and tighten battery connections.
	Battery discharged.	Recharge battery.
5. Check fuses.	Fuse(s) burnt out.	Replace fuse(s) (p. 87).
6. Remove and inspect spark plugs.	Spark plugs faulty, fouled or improperly gapped.	Clean, gap or replace spark plugs (p. 64).
	Spark plugs wet with fuel (flooded engine).	Dry and reinstall spark plugs. Start engine with the throttle open.
7. Use starting procedure (p. 36 ), then take outboard motor to an authorized Honda Marine dealer, or refer to the shop manual.	Fuel system malfunction, fuel pump failure, ignition malfunction, stuck valves, starter malfunction, switch malfunction, or electrical problem in the starting circuit, etc.	Replace or repair faulty components as necessary.

## TAKING CARE OF UNEXPECTED PROBLEMS

---

HARD STARTING OR STALLS AFTER STARTING	Possible Cause	Correction
1. Check control positions.	Fast idle lever raised (side-mount type).	Leave fast idle lever OFF (p. 18 ).
2. Check fuel.	Fuel hose not primed. Fuel pump filter or fuel tank clogged.	Squeeze priming bulb (p. 31 ). Replace fuel filters (p. 69 ).
	Bad fuel; boat stored without treating or draining gasoline, or refueled with bad fuel.	Drain fuel tank and vapor separator (p. 77). Refill with fresh gasoline (p. 67).

## TAKING CARE OF UNEXPECTED PROBLEMS

HARD STARTING OR STALLS AFTER STARTING (continued)	Possible Cause	Correction
3. Remove and inspect spark plugs.	Spark plugs faulty, fouled or improperly gapped.	Clean, gap or replace spark plugs (p. 64 ).
4. Take outboard motor to an authorized Honda Marine dealer, or refer to the shop manual.	Fuel system malfunction, fuel pump failure, ignition malfunction, etc.	Replace or repair faulty components as necessary.

ENGINE OVERHEATS	Possible Cause	Correction
1. Check water intake screens.	Water intake screens clogged.	Clean water intake screens.
2. Take outboard motor to an authorized Honda Marine dealer, or refer to the shop manual.	Faulty thermostat or water pump.	Replace or repair faulty components as necessary.



## TAKING CARE OF UNEXPECTED PROBLEMS

### BATTERY WILL NOT CHARGE AND ELECTRIC STARTER WILL NOT OPERATE

The battery-charging (ACG) circuit and the electric starter relay circuit are protected by the 10, 15 and 30-ampere main fuses and 150-ampere ACG fuse. If the fuse burns out, the engine will not charge the battery, and the electric starter will not operate.

The ignition switch is protected by the 10-ampere main fuse. If the fuse burns out, the engine will not start or run, and the power trim/tilt switch will not operate.

### Fuse Replacement

#### Main Fuse

1. With the engine stopped, remove the engine cover.
2. Remove the fuse covers.
3. Remove and inspect the fuses. If a fuse is burnt out, install a replacement fuse of the specified rating. The outboard motor is supplied with spare fuses in the fuse holders.

MAIN FUSES: 10 A, 15 A,  
30 A

#### NOTICE

*Never use a fuse with a rating greater than specified. Serious damage to the electrical system could result.*

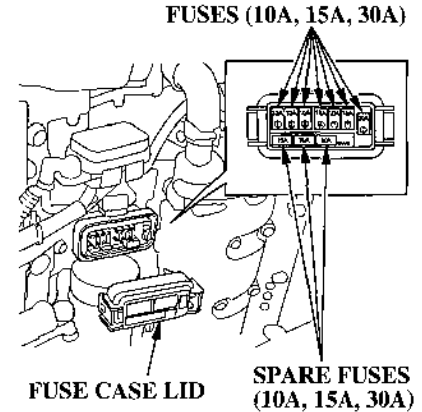

4. Reinstall the fuse covers and the engine cover.

Before further operation, try to determine and correct the electrical problem that caused the fuse to burn out. An uncorrected electrical problem may cause the fuse to burn out again.

## TAKING CARE OF UNEXPECTED PROBLEMS

### ACG Fuse

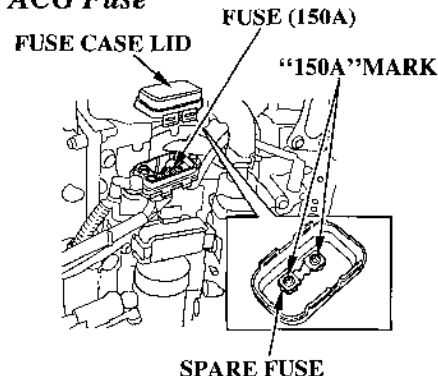

#### NOTICE

*Disconnect the battery cable at the battery negative (-) terminal before replacing the fuse. Failure to do so may cause a short circuit.*

### Replacement

1. Stop the engine.
2. Remove the engine cover.

3. Remove the fuse case lid.
4. Remove the old fuse by removing two 5 mm screws.
5. Install a new fuse with the "150 A" mark downward.

ACG FUSE: 150 A

6. After finishing replacement, install the fuse case lid with its hook toward the engine side.
7. Be sure to check the fuse case lid is securely locked.

A spare fuse is located on the reverse side of the fuse case lid and tightened with two 3 mm screws. When the new fuse is set as a spare fuse on the reverse side of the fuse case lid, set the fuse so that you can see the "150 A" mark on it.

## TAKING CARE OF UNEXPECTED PROBLEMS

### OIL PRESSURE INDICATOR LIGHT GOES OFF AND ENGINE SPEED IS LIMITED

#### *Side-Mount Type*

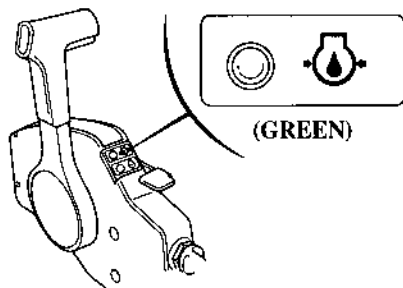

#### *Panel-Mount/Top-Mount Types*

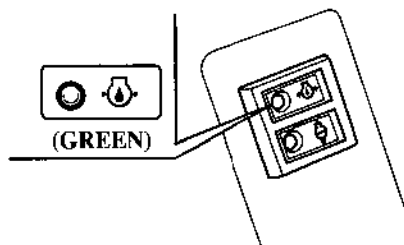

If oil pressure becomes low, the green indicator light will go off, and the engine protection system will limit engine speed. If you are at cruising speed, engine speed will decrease gradually.

Oil pressure indicator is also equipped with a buzzer that sounds when the green indicator light goes off.

Low oil pressure may be the result of a low engine oil level, or there may be a problem with the engine lubrication system.

If the throttle is closed suddenly after full throttle operation, engine speed may drop below the specified idle rpm, and that could activate the engine protection system momentarily.

If low oil pressure activates the engine protection system, stop the engine, check the engine oil level (p. 60), and add oil if needed.

With the engine oil at the recommended level, restart the engine. If the lubrication system is OK, the green indicator light should come on within 30 seconds, and the engine will respond normally to throttle control lever operation.

If the engine protection system remains activated after 30 seconds, return to the nearest boat landing, and have the outboard motor inspected by an authorized Honda marine dealer.

## TAKING CARE OF UNEXPECTED PROBLEMS

### OVERHEATING INDICATOR LIGHT COMES ON AND ENGINE SPEED IS LIMITED

#### *Side-Mount Type*

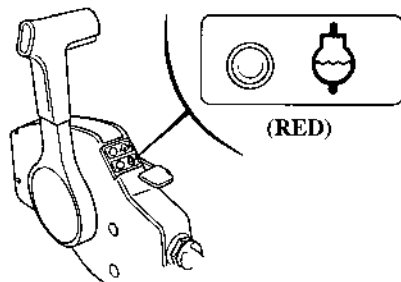

#### *Panel-Mount/Top-Mount Types*

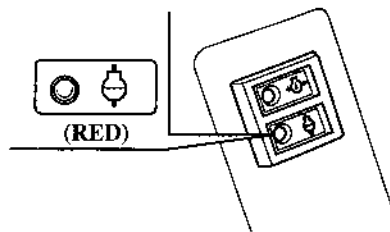

If the engine overheats, the red indicator light will come on, and the engine will stop in 20 seconds after the engine protection system will limit engine speed. If you are at cruising speed, engine speed will decrease gradually.

Remote-control types are equipped with a buzzer that sounds when the red indicator light comes on.

Engine overheating may be the result of clogged water intake screens, or there may be a problem with the cooling system thermostat or water pump.

If the engine is stopped after running at full throttle, and then restarted soon afterward, that could activate the engine protection system momentarily.

#### COOLING SYSTEM INDICATOR

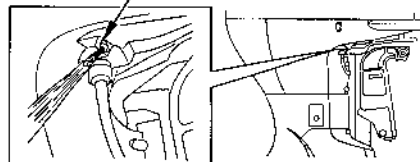

If overheating activates the engine protection system, idle the engine in neutral, and check the cooling system indicator.

If water is flowing from the cooling system indicator, continue idling for 30 seconds. If the cooling system is OK, the red indicator light should go off within 30 seconds, and the engine will respond normally to throttle control lever operation.

## TAKING CARE OF UNEXPECTED PROBLEMS

If there is no water flowing from the cooling system indicator, stop the engine, and tilt the outboard motor to inspect the water intake screens. If clogged, clean the water intake screens, return the outboard motor to the running position, restart the engine, and check the cooling system indicator again.

If there is still no water flowing from the cooling system indicator, or if the engine protection system remains activated after 30 seconds, return to the nearest boat landing, and have the outboard motor inspected by an authorized Honda marine dealer.

### WATER CONTAMINATION BUZZER SOUNDS

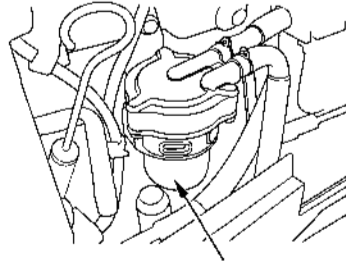

**WATER SEPARATOR**

When the water contamination buzzer sounds:

1. Check the water separator for water contamination. If water is accumulated, stop the engine, and clean the water separator following the instructions on page 72 , or consult with an authorized Honda outboard motor dealer.

### SUBMERGED MOTOR

A submerged outboard motor must be serviced immediately after it is recovered from the water in order to minimize corrosion.

If there is a Honda marine dealership nearby, take the motor to the dealer immediately. If you are far from a dealership, proceed as follows:

1. Remove the engine cover, and rinse the outboard motor with fresh water to remove salt water, sand, mud, etc.
2. Drain the vapor separator as described on p. 77.

## TAKING CARE OF UNEXPECTED PROBLEMS

---

3. Change the engine oil as described on p. 60 — 61 . If there was water in the engine crankcase, or if the used engine oil showed signs of water contamination, then a second engine oil change should be performed after running the engine for half an hour.

4. Remove the spark plugs (p. 64 ). Operate the starter to expell water from the engine's cylinder.

5. Put a teaspoon of engine oil into each spark plug hole to lubricate the inside of the cylinders. Reinstall the spark plugs.

If the engine was running when it submerged, there may be mechanical damage, such as bent connecting rods. If the engine binds when cranked, do not attempt to run the engine until it has been repaired.

6. Attempt to start the engine (be sure the water level is at least 2 inches above the antiventilation plate).

### NOTICE

*Running the outboard motor without sufficient cooling water will damage the water pump and overheat the engine.*

If the engine fails to start, remove the spark plugs, clean and dry them, then reinstall the spark plugs and attempt to start the engine again.

If the engine starts, and no mechanical damage is evident, continue to run the engine for a half hour or longer. Be sure the water level is at least two inches above the antiventilation plate to avoid overheating and water pump damage.

7. As soon as possible, take the outboard motor to an authorized Honda Marine dealer for inspection and service.

# TECHNICAL AND CONSUMER INFORMATION

## TECHNICAL INFORMATION

### Serial Number Locations

Record the product identification number and engine serial numbers in the space provided on this page. You will need these numbers when ordering parts, and when making technical or warranty inquiries (p. 103 ).

**PRODUCT  
IDENTIFICATION  
NUMBER**

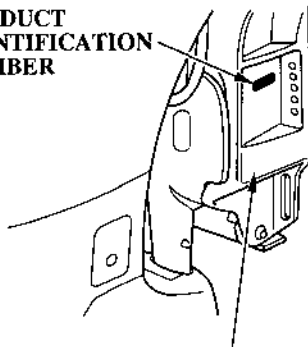

**STERN BRACKET**

The product identification number is stamped on a plate attached on the right stern bracket.

Product identification number:

---

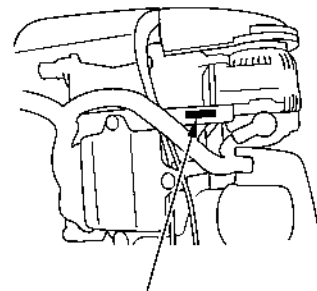

**ENGINE SERIAL NUMBER**

The engine serial number is stamped on the upper right side of the motor.

Engine serial number:

---

## TECHNICAL AND CONSUMER INFORMATION

---

### Oxygenated Fuels

Some conventional gasolines are being blended with alcohol or an ether compound. These gasolines are collectively referred to as oxygenated fuels. To meet clean air standards, some areas of the United States and Canada use oxygenated fuels to help reduce emissions.

If you use an oxygenated fuel, be sure it is unleaded and meets the minimum octane rating requirement.

Before using an oxygenated fuel, try to confirm the fuel's contents. Some states/provinces require this information to be posted on the pump.

The following are the EPA-approved percentages of oxygenates:

**ETHANOL:** ethyl or grain alcohol; 10% by volume.

You may use gasoline containing up to 10% ethanol by volume. Gasoline containing ethanol may be marketed under the name "Gasohol".

**MTBE:** Methyl Tertiary Butyl Ether; 15% by volume.

You may use gasoline containing up to 15% MTBE by volume.

**METHANOL:** methyl or wood alcohol; 5% by volume.



## TECHNICAL AND CONSUMER INFORMATION

---

You may use gasoline containing up to 5% methanol by volume, as long as it also contains cosolvents and corrosion inhibitors to protect the fuel system. Gasoline containing more than 5% methanol by volume may cause starting and/or performance problems. It may also damage metal, rubber, and plastic parts of your fuel system.

If you notice any undesirable operating symptoms, try another service station, or switch to another brand of gasoline.

Fuel system damage or performance problems resulting from the use of an oxygenated fuel containing more than the percentages of oxygenates mentioned above are not covered under warranty.

### **Battery**

For complete information, refer to the battery manufacture's instructions.

### **Minimum Requirements**

12V – 110AH

## TECHNICAL AND CONSUMER INFORMATION

---

### **Emission Control System Information**

#### *Source of Emissions*

The combustion process produces carbon monoxide, oxides of nitrogen, and hydrocarbons. Control of hydrocarbons and oxides of nitrogen is very important because, under certain conditions, they react to form photochemical smog when subjected to sunlight. Carbon monoxide does not react in the same way, but it is toxic.

Honda utilizes lean carburetor settings and other systems to reduce the emissions of carbon monoxide, oxides of nitrogen, and hydrocarbons.

### *The U.S. and California Clean Air Acts*

EPA and California regulations require all manufacturers to furnish written instructions describing the operation and maintenance of emission control systems.

The following instructions and procedures must be followed in order to keep the emissions from your Honda engine within the emission standards.

### *Tampering and Altering*

Tampering with or altering the emission control system may increase emissions beyond the legal limit. Among those acts that constitute tampering are:

- Removal or alteration of any part of the intake, fuel, or exhaust systems.
- Alterations that would cause the engine to operate outside its design parameters.

### *Problems That May Affect Emissions*

If you are aware of any of the following symptoms, have your engine inspected and repaired by your servicing dealer.

- Hard starting or stalling after starting.
- Rough idle.
- Misfiring or backfiring under load.
- Afterburning (backfiring).
- Black exhaust smoke or high fuel consumption.

### *Replacement Parts*

The emission control systems on your Honda engine were designed, built, and certified to conform with EPA and California emission regulations. We recommend the use of genuine Honda parts whenever you have maintenance done. These original-design replacement parts are manufactured to the same standards as the original parts, so you can be confident of their performance. The use of replacement parts that are not of the original design and quality may impair the effectiveness of your emission control system.

A manufacturer of an aftermarket part assumes the responsibility that the part will not adversely affect emission performance. The manufacturer or rebuilder of the part must certify that use of the part will not result in a failure of the engine to comply with emission regulations.

### *Maintenance*

Follow the maintenance schedule on p. 55. Remember that this schedule is based on the assumption that your machine will be used for its designed purpose. Sustained high-load operation, or use in unusual conditions, will require more frequent service.

## TECHNICAL AND CONSUMER INFORMATION

---

### Star Label

A Star label was applied to this outboard motor in accordance with the requirements of the California Air Resources Board.

### *The Star Label means Cleaner Marine Engine*

This engine has been certified as a:



### The Symbol for Cleaner Marine Engines:

**Cleaner Air and Water** - for healthier lifestyle and environment.

**Better Fuel Economy** - burns up to 30 - 40 percent less gas and oil than conventional carbureted two-stroke engines, saving money and resources.

**Longer Emission Warranty** - protects consumer for worry free operation.



### **One Star Low Emission**

The one-star label identifies engines that meet the Air Resources Board's 2001 exhaust emission standards. Engines meeting these standards have 75% lower emissions than conventional carbureted two-stroke engines. These engines are equivalent to the U.S. EPA's 2006 standards for marine engines.



### **Two Stars Very Low Emission**

The two-star label identifies engines that meet the Air Resources Board's 2004 exhaust emission standards. Engines meeting these standards have 20% lower emissions than One Star-Low-Emission engines.



### **Three Stars Ultra Low Emission**

The three-star label identifies engines that meet the Air Resources Board's 2008 exhaust emission standards. Engines meeting these standards have 65% lower emissions than One Star-Low-Emission engines.

Cleaner Watercraft - Get the Facts  
1-800-END-SMOG  
[www.arb.ca.gov](http://www.arb.ca.gov)

## TECHNICAL AND CONSUMER INFORMATION

### Specifications

MODEL	BF200A				
	BAEJ	BAEJ	BAFJ	BAEJ	BAFJ
Description Code	LA	XA	XCA	XXA	XXCA
Type	LA	XA	XCA	XXA	XXCA
Overall length	36.2 in (920 mm)				
Overall width	24.6 in (625 mm)				
Overall height	65.7 in (1,670 mm)	70.9 in (1,800 mm)	75.8 in (1,925 mm)		
Transom height	20.0 in (508 mm)	25.0 in (635 mm)	30.0 in (762 mm)		
Weight	589 lbs (267 kg)	600 lbs (272 kg)	611 lbs (277 kg)		
Rated power	147.1 kW (200 PS)				
Full throttle range	5,000–6,000 rpm				
Engine type	4 stroke SOHC 6-cylinder (V6)				
Displacement	211.7 cu-in (3,471 cm <sup>3</sup> )				
Spark plug gap	0.039–0.051 in (1.00–1.30 mm)				

Starter system	Electric starter
Ignition system	Fully transistorized, battery ignition
Lubrication system	Trochoid pump pressure lubrication
Specified oil	Engine: API standard (SG, SH, SJ) SAE 10W-30 Gear case: API standard (GL-4/5) SAE 90 outboard motor gear oil
Oil capacity	Engine: 8.0 US qt (7.6 ℓ , 6.7 Imp qt) Gear case: 1.00 US qt (0.95 ℓ , 0.84 Imp qt)
CARB star label	ULTRA · LOW EMISSION
D.C. output	12V–60A
Cooling system	Water cooling with thermostat
Exhaust system	Water exhaust
Spark plugs	VKJ20RZ-M11 (DENSO) IZFR6F11 (NGK)
Fuel pump	Electric powered mechanical
Fuel	Automotive unleaded gasoline (86 pump octane or higher)
Gear change	Forward-Neutral-Reverse (dog type)
Steering angle	30° right and left
Transom angle	0°–20°

Honda outboards are power rated in accordance with NMMA procedures and using the ICOMIA standard 28/23.

# TECHNICAL AND CONSUMER INFORMATION

## Specifications

MODEL	BF225A				
Description Code	BAGJ	BAGJ	BAHJ	BAGJ	BAHJ
Type	LA	XA	XCA	XXA	XXCA
Overall length	36.2 in (920 mm)				
Overall width	24.6 in (625 mm)				
Overall height	65.7 in (1,670 mm)	70.9 in (1,800 mm)		75.8 in (1,925 mm)	
Transom height	20.0 in (508 mm)	25.0 in (635 mm)		30.0 in (762 mm)	
Weight	589 lbs (267 kg)	600 lbs (272 kg)		611 lbs (277 kg)	
Rated power	165.5 kW (225 PS)				
Full throttle range	5,000–6,000 rpm				
Engine type	4 stroke SOHC VTEC 6-cylinder (V6)				
Displacement	211.7 cu-in (3,471 cm <sup>3</sup> )				
Spark plug gap	0.039–0.051 in (1.00–1.30 mm)				

Starter system	Electric starter
Ignition system	Fully transistorized, battery ignition
Lubrication system	Trochoid pump pressure lubrication
Specified oil	Engine: API standard (SG, SH, SJ) SAE 10W-30 Gear case: API standard (GL-4/5) SAE 90 outboard motor gear oil
Oil capacity	Engine: 8.0 US qt (7.6 ℓ , 6.7 Imp qt) Gear case: 1.00 US qt (0.95 ℓ , 0.84 Imp qt)
CARB star label	ULTRA · LOW EMISSION
D.C. output	12V–60A
Cooling system	Water cooling with thermostat
Exhaust system	Water exhaust
Spark plugs	VKJ20RZ-M11 (DENSO) IZFR6F11 (NGK)
Fuel pump	Electric powered mechanical
Fuel	Automotive unleaded gasoline (86 pump octane or higher)
Gear change	Forward-Neutral-Reverse (dog type)
Steering angle	30° right and left
Transom angle	0°–20°

Honda outboards are power rated in accordance with NMMA procedures and using the ICOMIA standard 28/23.

## TECHNICAL AND CONSUMER INFORMATION

---

### *BF200A & BF225A Tune up*

Spark plug gap	0.039—0.043 in (1.00—1.10 mm)	See page 65
Idle speed	650 ± 50 rpm	See shop manual
Valve clearance (cold)	Intake: 0.22 ± 0.02 mm Exhaust: 0.30 ± 0.02 mm	See shop manual
Other specifications	No other adjustments needed.	



# TECHNICAL AND CONSUMER INFORMATION

## CONSUMER INFORMATION

### **Honda Publications**

These publications will give you additional information for maintaining and repairing your outboard motor. You may order them from your Honda marine dealer.

#### *Shop Manual*

This manual covers complete maintenance and overhaul procedures. It is intended to be used by a skilled technician.

#### *Parts Catalog*

This manual provides complete, illustrated parts lists.

### **Customer Service Information**

Honda Marine dealership personnel are trained professionals. They should be able to answer any question you may have. If you encounter a problem that your dealer does not solve to your satisfaction, please discuss it with the dealership's management. The Service Manager or General Manager can help. Almost all problems are solved in this way.

If you are dissatisfied with the decision made by the dealership's management, contact the Honda Marine Customer Relations Office. You can write:

**American Honda Motor Co., Inc.**  
Marine Division  
Customer Relations Office  
4900 Marconi Drive  
Alpharetta, Georgia 30005-8847

Or telephone: (770) 497-6400

When you write or call, please give us this information:

- Model and serial numbers (p. 93 )
- Name of the dealer who sold the outboard motor to you
- Name and address of the dealer who services your outboard motor
- Date of purchase
- Your name, address, and telephone number
- A detailed description of the problem

# INDEX

Alternator (ACG) Indicator.....	28	Emission Control System Information .....	96
Anodes.....	31	Engine	
Replacement.....	73	Cover	
ARE YOU READY TO GET UNDER WAY ? .....	32	Latch.....	27
Battery .....	95	Lock Lever Adjustment .....	59
BATTERY WILL NOT CHARGE AND		Lock Lever Bracket Adjustment.....	59
ELECTRIC STARTER WILL NOT OPERATE.....	87	REMOVAL AND INSTALLATION.....	58
BEFORE OPERATION.....	32	Oil	
BREAK-IN PROCEDURE.....	34	Change.....	60
Common Controls .....	25	Level Check .....	60
COMPONENT AND CONTROL LOCATIONS .....	11	Recommendations .....	62
CONSUMER INFORMATION .....	103		
CONTROLS.....	15		
CONTROLS AND FEATURE IDENTIFICATION			
CODES.....	10		
CONTROLS AND FEATURES .....	10		
Cooling System Indicator.....	30		
CRUISING.....	48		
Customer Service Information.....	103		

<p>Fast Idle Lever..... 18</p> <p>Fuel</p> <p style="padding-left: 20px;">PRIMING..... 35</p> <p style="padding-left: 20px;">Priming Bulb ..... 31</p> <p style="padding-left: 20px;">RECOMMENDATIONS..... 68</p> <p style="padding-left: 20px;">Pump Filter Inspection and Replacement ..... 69</p> <p>Gear Oil Level Check..... 63</p> <p>Gearshift/Trottle Control Lever</p> <p style="padding-left: 20px;">Panel-Mount Type..... 20</p> <p style="padding-left: 20px;">Side-Mount Type ..... 16</p> <p style="padding-left: 20px;">Top-Mount Type..... 23</p> <p>GEARSHIFTING AND THROTTLE OPERATION... 45</p> <p style="padding-left: 20px;">Panel-Mount Type..... 46</p> <p style="padding-left: 20px;">Side-Mount Type ..... 45</p> <p style="padding-left: 20px;">Top-Mount Type..... 46</p> <p>HOISTING THE OUTBOARD MOTOR..... 78</p>	<p>Ignition Switch</p> <p style="padding-left: 20px;">Panel-Mount Type..... 18</p> <p style="padding-left: 20px;">Side-Mount Type ..... 15</p> <p style="padding-left: 20px;">Top-Mount Type..... 22</p> <p>IMPORTANT SAFETY INFORMATION..... 7</p> <p>INDICATORS..... 28</p> <p>INSTRUMENTS..... 27</p> <p>IS YOUR OUTBOARD MOTOR READY TO GO ? ..... 32</p> <p>Lubrication Points ..... 63</p> <p>MAINTENANCE SAFETY..... 53</p> <p>MAINTENANCE SCHEDULE ..... 55</p> <p>MOORING, BEACHING, LAUNCHING..... 50</p>
---	---

# INDEX

---

Oil Pressure Indicator .....	29	SAFE OPERATING PRECAUTIONS .....	34
<b>OIL PRESSURE INDICATOR LIGHT GOES</b>		<b>SAFETY LABEL LOCATIONS .....</b>	<b>9</b>
<b>OFF AND ENGINE SPEED IS LIMITED .....</b>	<b>89</b>	Serial Number Locations.....	93
<b>OPERATION .....</b>	<b>34</b>	<b>SERVICING YOUR OUTBOARD MOTOR .....</b>	<b>52</b>
<b>OTHER FEATURES .....</b>	<b>31</b>	<b>SHALLOW WATER OPERATIONS.....</b>	<b>50</b>
<b>OUTBOARD MOTOR SAFETY .....</b>	<b>7</b>	Spark Plug Service .....	64
Overheating Indicator.....	29	Specifications .....	100
<b>OVERHEATING INDICATOR LIGHT COMES</b>		Star Label .....	98
<b>ON AND ENGINE SPEED IS LIMITED.....</b>	<b>90</b>	<b>STARTING THE ENGINE .....</b>	<b>36</b>
Overrev Limiter.....	31	Panel-Mount Type.....	39
Oxygenated Fuels.....	94	Side-Mount Type .....	36
		Top-Mount Type .....	41
Power Tilt Switch.....	26	<b>STEERING.....</b>	<b>47</b>
Power Trim/Tilt Switch .....	25	<b>STOPPING THE ENGINE.....</b>	<b>43</b>
Programmed Fuel Injection (PGM-FI) Indicator.....	28	Emergency Engine Stopping.....	43
Propeller Replacement .....	74	Normal Engine Stopping.....	44
		<b>STORAGE .....</b>	<b>75</b>
<b>REMOVAL FROM STORAGE.....</b>	<b>80</b>	<b>STORAGE PRECAUTIONS.....</b>	<b>79</b>
		<b>STORAGE PREPARATION.....</b>	<b>75</b>
		Cleaning and Flushing .....	75
		Engine oil .....	78
		Fuel.....	77
		<b>SUBMERGED MOTOR.....</b>	<b>91</b>
		Switch Clip and Emergency Stop Switch	
		Panel-Mount Type.....	19
		Side-Mount Type .....	16
		Top-Mount Type .....	22

---

Tachometer (optional equipment).....	28
TAKING CARE OF UNEXPECTED PROBLEMS.....	82
TECHNICAL AND CONSUMER INFORMATION...	93
TECHNICAL INFORMATION .....	93
THE IMPORTANCE OF MAINTENANCE .....	52
Throttle Button	
Panel-Mount Type.....	20
Top-Mount Type .....	23
Tilt Lock Lever.....	26
TOOL KIT (optional equipment).....	54
TRANSPORTING .....	81
WITH OUTBOARD MOTOR INSTALLED	
ON BOAT .....	81
WITH OUTBOARD MOTOR REMOVED	
FROM BOAT .....	81
Trim Meter (optional equipment) .....	27
Trim Tab.....	27
TRIM TAB ADJUSTMENT .....	57
Water Separator.....	71
WIRING DIAGRAMS.....	Inside Back Cover

## SIDE-MOUNT TYPE

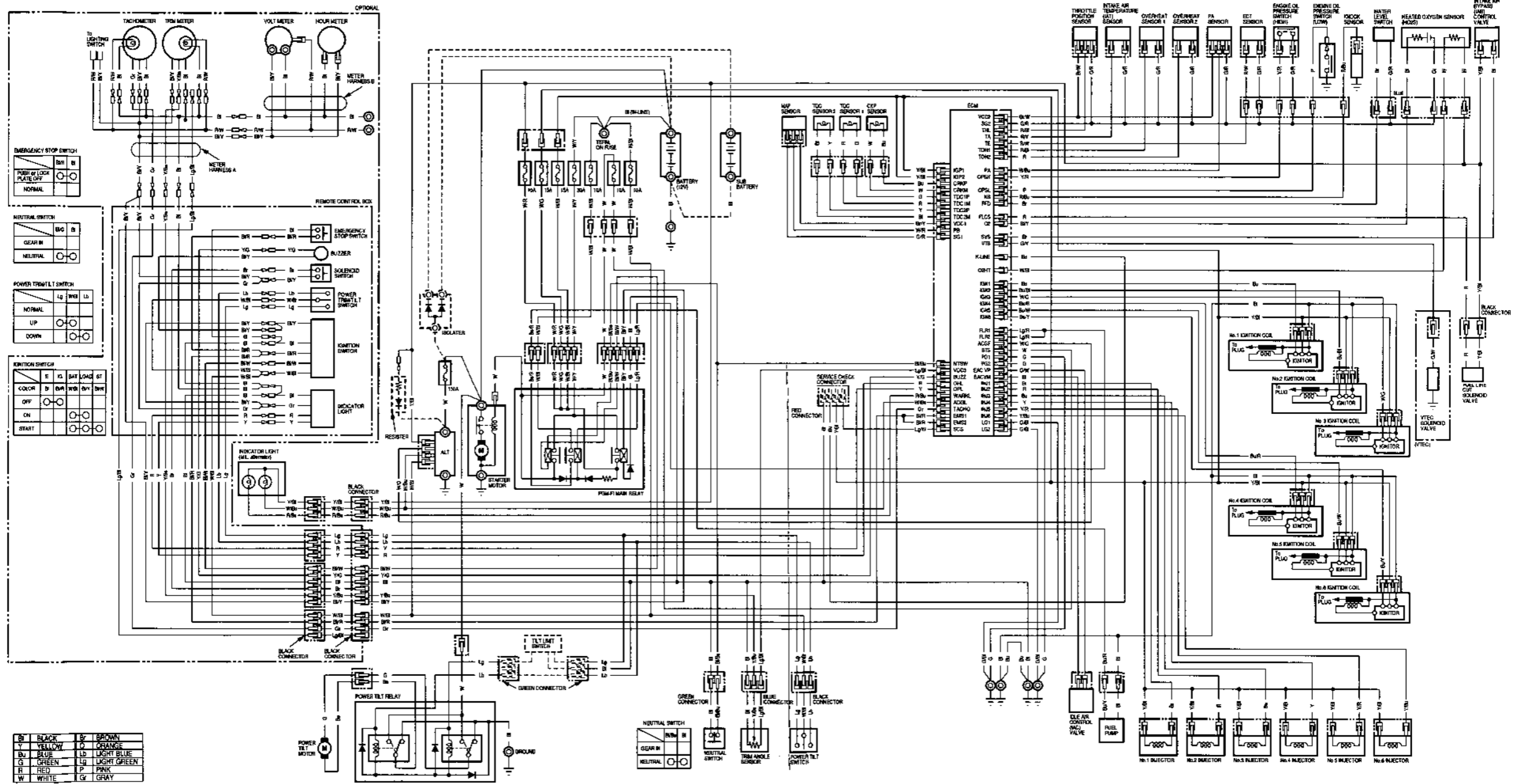

# WIRING DIAGRAM

## PANEL/TOP-MOUNT

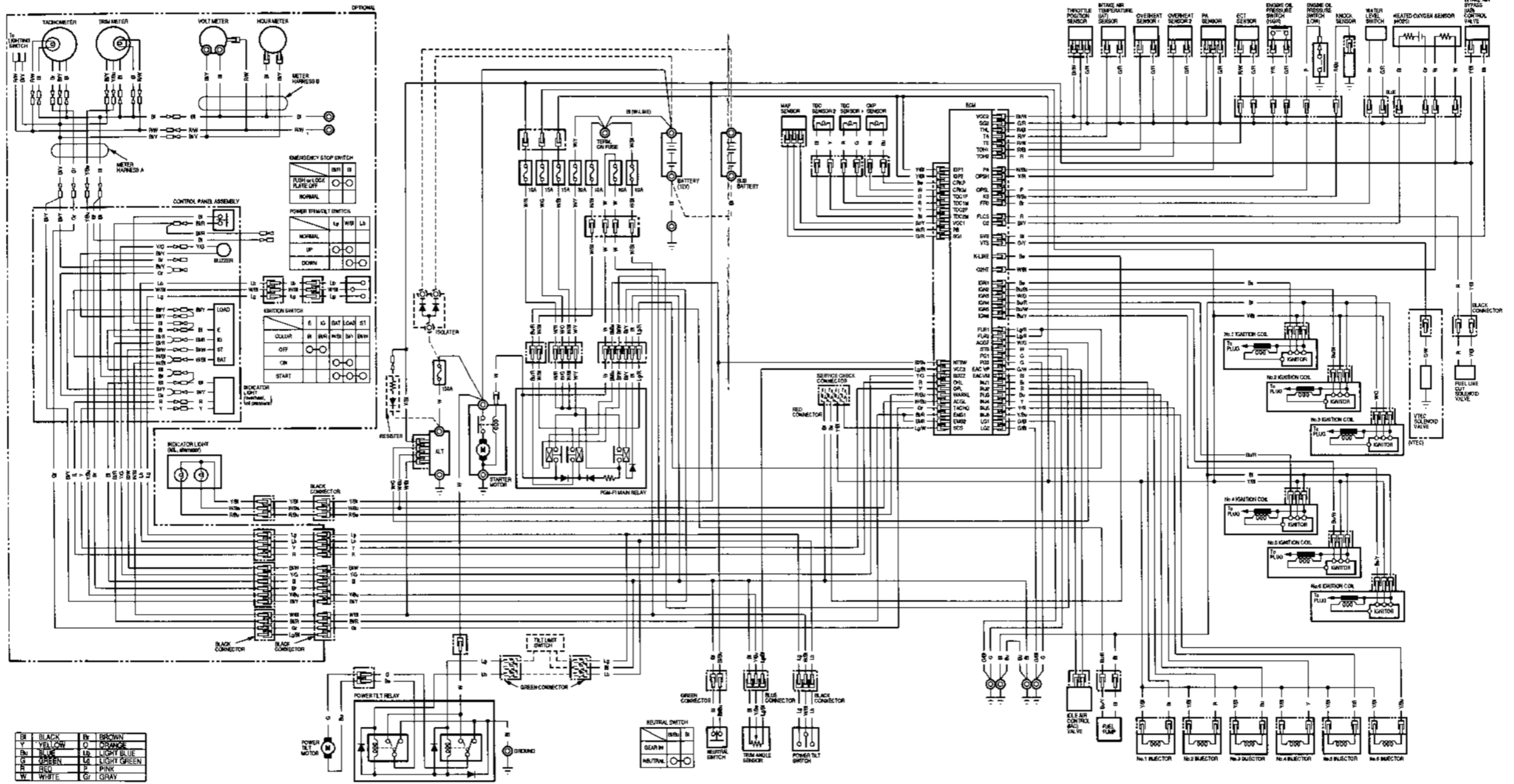

# HONDA

The power of dreams.™

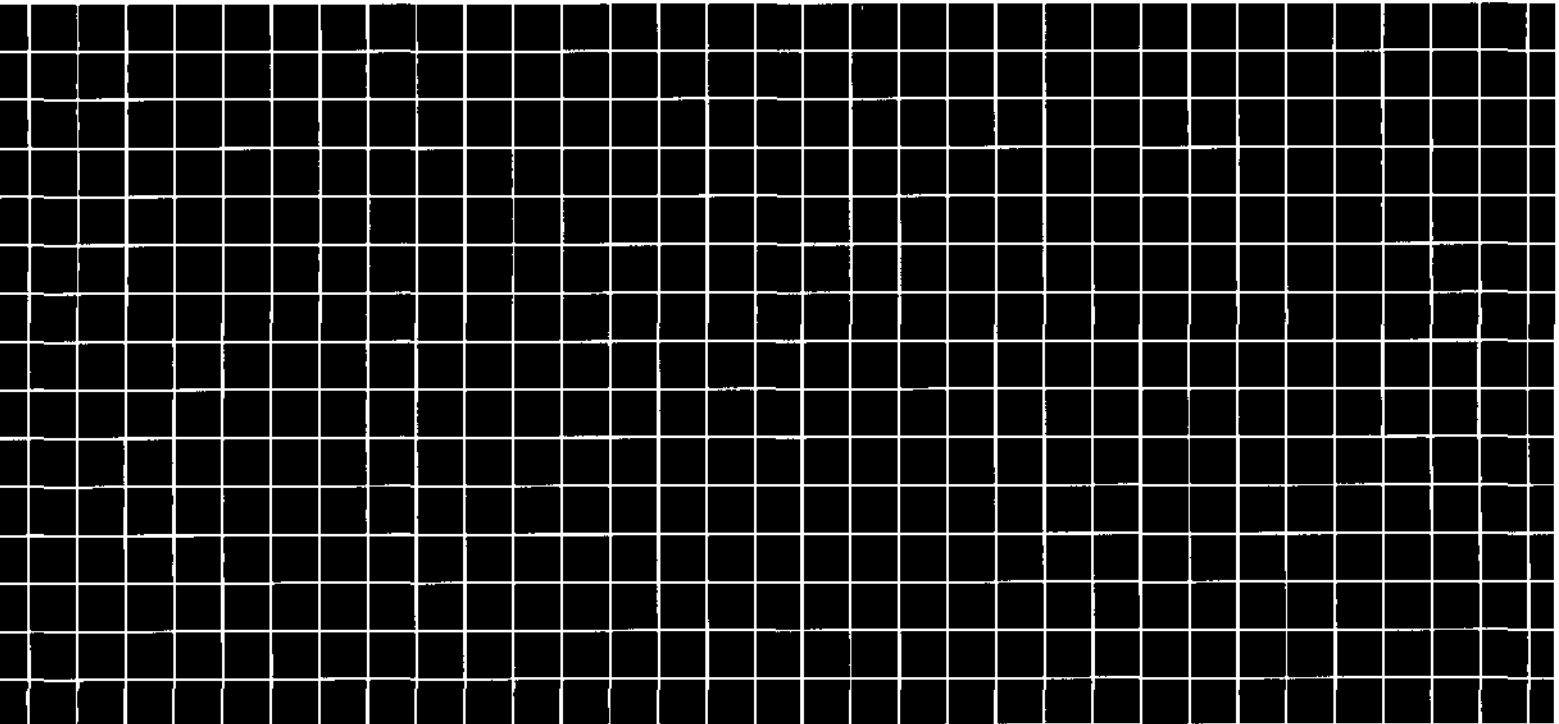

31ZY2600  
00X31-ZY2-6000

**EM3**

(AH)

(英)

(Y)

(HC)

1000.2001.10

Printed in Japan