

Compaq iPAQ PCD-1 Personal CD Player

User Guide

Notice

© 2001 Compaq Computer Corporation

COMPAQ and the Compaq logo registered in U.S. Patent and Trademark Office.

iPAQ is a trademark of Compaq Information Technologies Group, L.P.

Microsoft and Windows are trademarks of Microsoft Corporation.

All other product names mentioned herein may be trademarks or registered trademarks of their respective companies.

Compaq shall not be liable for technical or editorial errors or omissions contained herein. The information in this document is subject to change without notice.

The information in this publication is subject to change without notice and is provided "AS IS" WITHOUT WARRANTY OF ANY KIND. THE ENTIRE RISK ARISING OUT OF THE USE OF THIS INFORMATION REMAINS WITH RECIPIENT. IN NO EVENT SHALL COMPAQ BE LIABLE FOR ANY DIRECT, CONSEQUENTIAL, INCIDENTAL, SPECIAL, PUNITIVE, OR OTHER DAMAGES WHATSOEVER (INCLUDING WITHOUT LIMITATION, DAMAGES FOR LOSS OF BUSINESS PROFITS, BUSINESS INTERRUPTION, OR LOSS OF BUSINESS INFORMATION), EVEN IF COMPAQ HAS BEEN ADVISED OF THE POSSIBILITY OF SUCH DAMAGES. THE FOREGOING SHALL APPLY REGARDLESS OF THE NEGLIGENCE OR OTHER FAULT OF EITHER PARTY AND REGARDLESS OF WHETHER SUCH LIABILITY SOUNDS IN CONTRACT, NEGLIGENCE, TORT, OR ANY OTHER THEORY OF LEGAL LIABILITY, AND NOTWITHSTANDING ANY FAILURE OF ESSENTIAL PURPOSE OF ANY LIMITED REMEDY.

The limited warranties for Compaq products are exclusively set forth in the documentation accompanying such products. Nothing herein should be construed as constituting a further or additional warranty.

Compaq

iPAQ Personal CD Player PCD-1

First Edition (July 2001)

Part Number 253997-001

Setting Up Your Player

Thanks for buying a Compaq iPAQ Personal CD Player PCD-1, and welcome to the world of digital audio.

What is Digital Audio?

Digital audio is a way of compressing recorded sound so that it takes up much less storage space. A song is reduced to about 1/10 its size, allowing you to store much more music on one CD. There are many types of digital audio formats, but MP3 and WMA are two of the most popular.

Why Digital Audio?

Digital CD players provide many benefits:

- > Up to 20 hours of music on one CD
- > High quality sound
- > Organization and personalization of your music
- > The ability to take your favorite music with you anywhere!

Is Your PC Ready for Digital Audio?

If you have a multimedia PC with a CD-RW or DVD-RW drive, you are probably ready to create CDs. To use the MusicMatch Jukebox 6.1 software included on the CD with your PCD-1, we recommend the following requirements.

- > 233 MHz processor
- > Microsoft Windows 95 (with service pack 1), Windows NT 4.0 (with service pack 4), Windows 98, Windows ME, Windows 2000, or Windows XP
- > 100 MB free hard drive space
- > CD-RW or DVD-RW drive
- > 64 MB RAM

How to Get Help

If you have any trouble setting up your PCD-1 or would just like more information, visit Compaq's Web site:

<http://www.compaq.com/iPAQaudio>

Register Your PCD-1

Please register your PCD-1 to receive a more personalized support experience. You may register at Compaq's Web site:

<http://www.compaq.com/go/register>

Warranty

Your PCD-1 has a One-Year Limited Warranty. Please see the enclosed Warranty Card for further details.

What's in the Box?

Your iPAQ PCD-1 package contains the following components.



- ❶ Personal CD Player
- ❷ Headphones
- ❸ AC power adapter
- ❹ Two AA rechargeable batteries
- ❺ Installation CD
- ❻ Getting Started guide
- ❼ Remote control (with battery)

Installing the Batteries

Your iPAQ Personal CD Player PCD-1 is equipped with rechargeable batteries. You can listen to your favorite music on battery power or you can plug the PCD-1 into a standard electrical outlet.

To install the batteries, just follow these simple steps:

1. Pull out and lift the **battery door**.

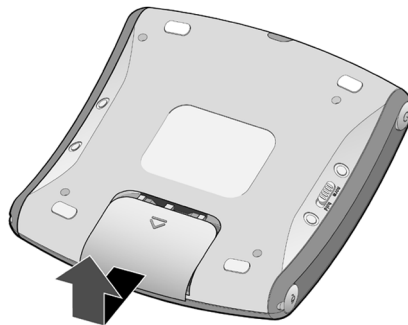

2. Place the rechargeable batteries that came with your PCD-1 into the battery compartment according to the diagram inside the compartment.

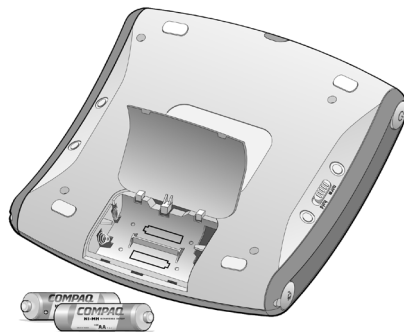

Tip: To recharge the batteries that came with your PCD-1, just plug the PCD-1 into a standard electrical outlet while the batteries are in the battery compartment. The battery icon on the display screen shows the amount of charge held by the batteries (when the PCD-1 is not plugged into an AC electrical outlet).

WARNING: Do not mix rechargeable batteries with non-rechargeable batteries.

Turning On Your PCD-1

To turn on your iPAQ Personal CD Player PCD-1, press the **Power** button.



When you turn on your PCD-1, the LCD screen briefly displays **Compaq iPAQ PCD-1**, followed by the message “Reading Disc.” If there is no disc loaded, you will receive the message “No Disc.” If a disc is loaded, you will receive the message “Searching for audio.” If audio files are present, the PCD-1 will list the number of tracks found then begin playing the first track. If no audio tracks are found, it will display the message “No Audio Found.”

Side Features of Your Player

The left and right sides of your PCD-1 have several important features.

Note that the side features have icons associated with them to help identify their functions.

The Audio Out ❶ and Power Supply ❺ connections are covered by rubber plugs that must be pulled back to make the connections.

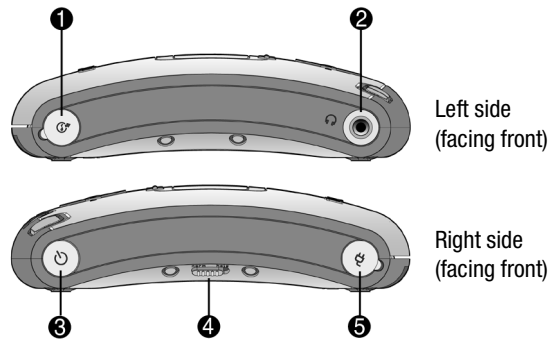

- ❶ **Audio Out** - Allows you to plug your PCD-1 into your home stereo system (cable not supplied).
- ❷ **Earphone Connection** - Plug in your headphones here to listen to CDs (headphones supplied).
- ❸ **Power button** - Press to turn the PCD-1 on. Hold for two seconds to turn the PCD-1 off.

WARNING: Permanent hearing loss may occur if headphones are used at high volume.

- ❹ **Norm/Hold Switch** - The Norm/Hold switch should be in the Norm position for typical usage. **When the switch is in the Hold position, the front panel buttons are disabled.** In the Hold position, you can carry your PCD-1 in a pouch or purse and not worry about accidentally pushing the buttons.

Tip: You must set the **Norm/Hold** switch to the **Normal** position to turn on the PCD-1. A **“Hold is on!”** message is displayed on the screen if the switch is in the **Hold** position when you press the **Power** button. After displaying the message, the PCD-1 shuts off.

- ❺ **Power Supply Connection** - Plug in your AC power adapter here to run the PCD-1 from a standard electrical outlet.

Note: Power off your PCD-1 before connecting it to AC power.

Front Features of Your PCD-1

Your PCD-1 has many outstanding features.

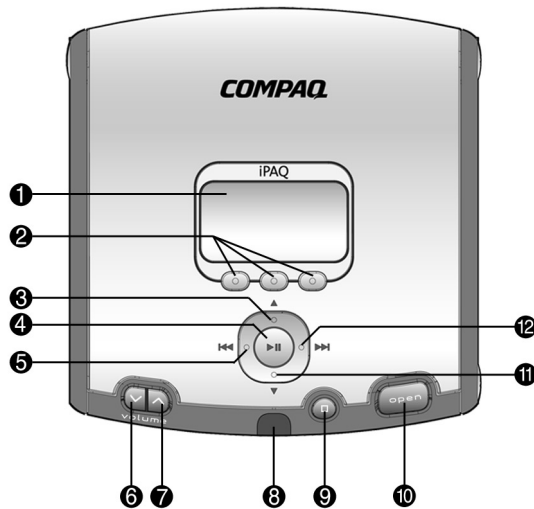

- ❶ **Display Screen** - Area where song and playback information is displayed along with icons and option button labels. Also displays FM radio stations.
- ❷ **Option Buttons** - Switch to modes of operation displayed above the buttons.
- ❸ **Up** - Scrolls up through playlists, tracks, and FM radio station presets.
- ❹ **Play/Pause** - Press to play a song. Press again to pause play.
- ❺ **Rewind/Previous Track** - Press and hold to rewind within a song or scan to previous station in Radio mode. Press once to skip back to the previous track or tune the FM radio station.
- ❻ **Volume Decrease** - Press to lower volume level.
- ❼ **Volume Increase** - Press to raise volume level.
- ❽ **Infrared Receiver** - Receives an infrared signal from the remote control.
- ❾ **Stop** - Press to stop play and view track directory.
- ❿ **Open** - Opens the CD door.
- ⓫ **Down** - Scrolls down through playlists, tracks, and FM radio station presets.
- ⓬ **Fast Forward/Next Track** - Press and hold to fast forward within a song or scan to next station in Radio mode. Press once to skip ahead to the next song or tune the FM radio.





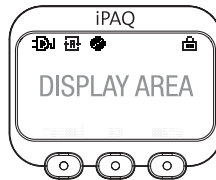



PCD-1 Display Screen

The Display Screen shows icons along the top, a large display area in the center, and option button labels along the bottom.



Display Icons

The following table lists the various display icons you will see along the top of the display screen and explains what they represent.

-  **Play** - Indicates that a CD is playing.
-  **Pause** - Indicates the CD is paused.
-  **Power** - Indicates that the AC power adapter is plugged in.
-  **Battery charge indicator** - The number of bars visible indicates the amount of charge remaining in your PCD-1's batteries (displays only if batteries are present and the PCD-1 is not plugged in).
-  **Lock** - Displays when the Norm/Hold switch is in the Hold position, locking all the buttons on the PCD-1 and the remote control.
-  **Repeat one** - Indicates that the current track is set to repeat.
-  **Repeat all** - Indicates that all tracks are set to repeat.
-  **Shuffle** - Indicates that tracks will be played in a non-sequential order.
-  **Playlist** - Indicates the PCD-1 is in Playlist/Track Management mode.

Display Area

The display area contains different types of information, depending on what mode of operation the PCD-1 is in. For example, it can display a list of playlists and tracks, information about the disc, default settings, and radio stations.

While a disc is playing, the display area shows the track number, elapsed time, artist, and song title. The song title format reads ID3 information, which is set using the software included with your PCD-1.

Option Button Labels

The information along the bottom of the display area shows the labels for the option buttons located just below the display area. The labels (and the functionality of the buttons) change when you switch to different modes. The various option button labels and functions are listed below.

Album - Sorts tracks by album names.

Artist - Sorts tracks by artist names.

Disc - Switches the PCD-1 to Playlist/Track Management mode, where you can select playlists and tracks.

EQ - Toggles between equalizer settings Flat, Rock, Latin, Dance, Jazz, and User (user-defined bass/treble levels).

File - Sorts tracks by file names.

Genre - Sorts tracks by genres.

Info - Switches the PCD-1 to System/Disc Information mode, where you can view information about the current disc and the PCD-1's operating software.

Menu - Switches the PCD-1 to Menu/LCD Control mode, where you can adjust the PCD-1's settings.

Radio - Switches the PCD-1 to Radio mode, where you can listen to local FM radio stations.

Repeat - Toggles between repeat modes Repeat One, Repeat All, Shuffle, and None (sequential).

Set - Assigns a preset number to the radio station you are currently tuned in to.

Title - Sorts tracks by song titles.

Remote Control Features

The PCD-1 remote control has many of the same features as the front of the player. The remote control allows you to conveniently make adjustments to the PCD-1 while it is hooked up to your home stereo system.

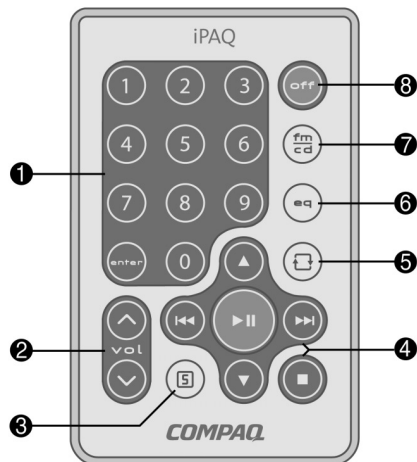

- 1 Number Pad** - In CD mode, enter a number, then press **enter** to play the track associated with the number you entered.
- 2 Volume Buttons** - Press the Up and Down buttons to increase and decrease volume.
- 3 Shuffle Button** - Press to play tracks on the CD in a nonsequential order.
- 4 Navigation Buttons** - (See the description of the front of the PCD-1 on page 5 for details.)
- 5 Repeat Button** - Press to switch between Repeat One, Repeat All, and Shuffle repeat modes.
- 6 Equalizer Button** - Press to toggle between equalizer settings.
- 7 FM/CD Button** - Press to switch between the CD player and FM radio.
- 8 Off button** - Press to turn the PCD-1 off.

Tip: You must power on the PCD-1 by pressing the Power button on the side of the player. The remote control can turn the player off but will not turn it on.

Note: See page 9 for information on installing the battery in the remote control.

Remote Control Signal Distances

The signal from the PCD-1 remote control will reach the player from a maximum distance of approximately 12 feet (3.8 meters) to 52 feet (16 meters), depending on the angle of the signal.

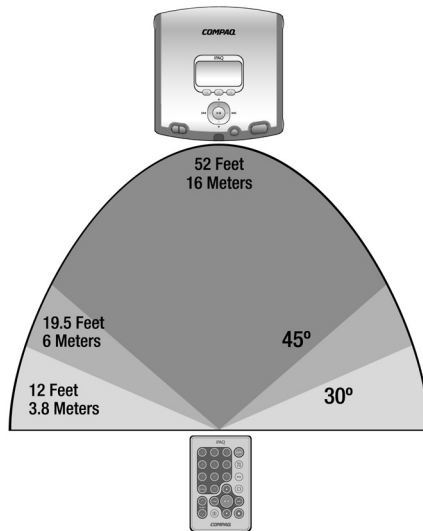

Installing the Remote Control Battery

To install the battery in the remote control, slide out the battery tray on the back of the remote control and place the battery in the tray as shown below. Then slide the battery tray back in.



Modes of Operation

Your PCD-1 has several modes of operation. Not only can you listen to your favorite music, you can also adjust many of the control and menu features. Press the option buttons below the display window to switch between modes.

The following list is an overview of the various modes of operation.

Playlist/Track Management mode - To view and select playlists and tracks.

Playback mode - To play CDs.

Radio mode - To listen to local FM radio stations.

System/Disc Information mode - To view information about the current CD and the player's operating software.

Menu/LCD Control mode - To adjust the PCD-1's default settings and create a custom equalizer setting.

Playlist/Track Management Mode

In Playlist/Track Management mode, you can use the Navigation buttons to view: a list of playlists; a list of tracks in each playlist; and information about each track. You can also select tracks or playlists and begin playing them. To switch to a different mode, use the option buttons under the display screen.



Option Button Functions

Radio - Switches the player to Radio mode. See the *Radio Mode* section on page 14 for more information.

File, Title, Artist, Album, Genre, or Info - If you are viewing a list of tracks, the middle option button indicates the sort order of the tracks, which will be either **File**, **Title**, **Artist**, **Album**, or **Genre**. Pressing this option button toggles between these different sort orders.

If you are viewing a list of playlists or information about a track, the middle option button will be **Info**, which switches the player to System/Disc Information mode. See the *System/Disc Information Mode* section on page 15 for more information.

Menu - Switches the player to Menu/LCD Control mode. See the *Menu/LCD Control Mode* section on page 16 for more information.

Playlist/Track Management Functions

In Playlist/Track Management mode, you can view a list of playlists, a list of tracks in each playlist, and information about each track.

Playlist directory - displays a list of playlists on the CD in alphabetical order. You can scroll through and select the playlist you want to hear.

Note: If playlists were not created at the time the CD was recorded, there will be only one “master” playlist called “All Tracks” that contains all the tracks on the CD.

The following table shows the Navigation button functions while in the Playlist directory.

Button	Function
▶ Play	Begin playing first track in playlist (according to repeat mode) and switch to Playback mode
▶▶ Fast Forward	Switch to Track directory
▲ Up	Scroll up through playlists
▼ Down	Scroll down through playlists

Track directory - displays a list of tracks in the selected playlist. You can scroll through and select a track you want to hear.

The following table shows the Navigation button functions while in the Track directory.

Button	Function
▶ Play	Begin playing currently selected track and switch to Playback mode
◀◀ Rewind	Return to Playlist directory
□ Stop	Include/exclude currently selected track
▶▶ Fast Forward	Switch to Track Information directory
▲ Up	Scroll up through tracks
▼ Down	Scroll down through tracks

Track Information directory - displays the title, artist, album, genre, and year information of the selected track along with the index on the CD.

The following table shows the Navigation button functions in the Track Information directory.

Button	Function
▶ Play	Begin playing currently selected track and switch to Playback mode
◀◀ Rewind	Return to Track directory

Playback Mode

In Playback mode, you can listen to CDs, adjust the repeat and equalizer settings, view the artist and title information, and pause play.

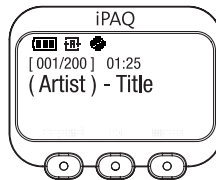

Option Button Functions

Repeat - Toggles between the following Repeat settings:

- > Repeat One - The current song plays again and again.
- > Repeat All - Continuously plays all the songs in your playlist in the order in which they are listed.
- > Shuffle - Plays all the songs in your playlist in random order.
- > None - Plays all the songs in your playlist in the order in which they are listed.

EQ - Toggles between the following Equalizer settings:

- > Flat - Choose this setting to flatten the bass and treble settings.
- > Rock - Choose this setting to hear Rock music at its best.
- > Latin - Choose this setting to hear Latin music at its best.
- > Dance - Choose this setting to hear Dance music at its best.
- > Jazz - Choose this setting to hear Jazz music at its best.
- > User - Choose this setting if you want to hear your favorite music with the bass and treble settings manually adjusted. (To access custom bass and treble settings, you must press the Menu button and go into Menu/LCD Control mode. Your custom bass and treble levels create the User equalizer setting.)

Menu - Switches the player to Menu/LCD Control mode. See the *Menu/LCD Control Mode* section on page 16 for more information.

Playback Functions

In Playback mode, you can play your playlists/tracks or you can pause play.

Play - While a track is playing, the display screen shows the artist and title information along with the elapsed time of play. If no artist/title information is available on the disc, the display screen shows the filename.

The following table shows the Navigation button functions while in Play mode.

Button	Function
▶▶ Play	If a track is playing, switches the player to Pause mode.
◀◀ Rewind	Skips to beginning of current track, or to the previously played track if at the beginning of a track. Holding down the Rewind button scans backward through the current and previous tracks.
□ Stop	Stops play and switches to Playlist/Track Management mode. The last track played will be highlighted on the display screen.
▶▶▶ Fast Forward	Skips to next track (according to Repeat setting). Holding down the Fast Forward button scans forward through the current and next tracks.

Pause - When play is paused, the elapsed time on the display screen flashes.

The following table shows the Navigation button functions while play is paused.

Button	Function
▶▶ Play	Switches to Play mode.
◀◀ Rewind	Skips to beginning of current track, or to the previously played track if at the beginning of a track. Holding down the Rewind button scans backward through the current and previous tracks. Playback does not automatically resume.
□ Stop	Stops play and switches to Playlist/Track Management mode. The last track played will be highlighted on the display screen. Playback does not automatically resume.
▶▶▶ Fast Forward	Skips to next track (according to Repeat setting). Holding down the Fast Forward button scans forward through the current and next tracks.

Radio Mode

In Radio mode, you can listen to local FM radio stations. You can also assign preset numbers to the frequency of your favorite FM stations. The display screen shows the current station's frequency and its preset number (if the station has been assigned a preset number).

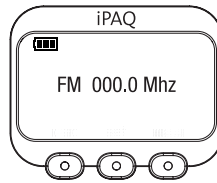

Option Button Functions

Disc - Switches the player to Playlist/Track Management mode with the last track played highlighted on the display screen. See the *Playlist/Track Management Mode* section on page 10 for more information.

Set - Assigns the current station a preset number for quick access to the station's frequency (there are five presets available).

Menu - Switches the player to Menu/LCD Control mode. See the *Menu/LCD Control Mode* section on page 16 for more information.

Radio Navigation Button Functions

The following table shows the Navigation button functions while in Radio mode.

Button	Function
▶▶ Play	Tunes into the selected radio station frequency and begins playing.
◀◀ Rewind	Scans backwards through radio station frequencies. Pressing the Set option button assigns the frequency to the currently selected preset number. Holding down the Rewind button causes the player to seek backwards to find the previous acceptable radio station signal based on strength. An "AUTO" icon is displayed as it scrolls through the frequencies.
□ Stop	Clears the currently selected preset number.
▶▶▶ Fast Forward	Scans forward through radio station frequencies. Pressing the Set option button assigns the frequency to the currently selected preset number. Holding down the Fast Forward button causes the player to seek forward to find the next acceptable radio station signal based on strength. An "AUTO" icon is displayed as it scrolls through the frequencies.
▲ Up	Scrolls up through presets.
▼ Down	Scrolls down through presets.

System/Disc Information Mode

In System/Disc Information mode, you can view information about the player's operating software as well as information about the disc currently loaded in the player.

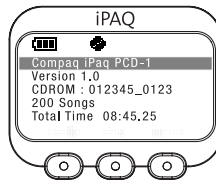

Option Button Functions

Radio - Switches the player to Radio mode and begins playing the last station that you tuned into. See the *Radio Mode* section on page 14 for more information.

Disc - Switches the player to Playlist/Track Management mode with the last track that was played highlighted. See the *Playlist/Track Management Mode* section on page 10 for more information.

Menu - Switches the player to Menu/LCD Control mode. See the *Menu/LCD Control Mode* section on page 16 for more information.

Navigation Button Functions

The only navigation buttons functional in System/Disc Information mode are the **Up** and **Down** buttons. Use these buttons to scroll through and view the following information.

> Operating software version

Note: A disc must be loaded in the player to view the following information about that disc.

> Volume label (if available) of the currently loaded CD

> Number of tracks on the currently loaded disc

> Total playing time on the currently loaded disc

Menu/LCD Control Mode

In Menu/LCD Control mode, you can change your player's default settings. The display screen shows a list of changeable functions and the current settings.



Option Button Functions

Radio - Switches the player to Radio mode. See the *Radio Mode* section on page 14 for more information.

Disc - Switches the player to Playlist/Track Management mode. See the *Playlist/Track Management Mode* section on page 10 for more information.

Info - Switches the player to System/Disc Information mode. See the *System/Disc Information Mode* section on page 15 for more information.

Navigation Button Functions

The following table shows the Navigation button functions while in Menu/LCD Control mode.

Button	Function
◀◀ Rewind	Scrolls backwards through the options for the selected function.
□ Stop	Cancels all option changes and restores the previous settings.
▶▶ Fast Forward	Scrolls forward through the options for the selected function.
▲ Up	Scrolls up to select a function to be changed.
▼ Down	Scrolls down to select a function to be changed.

Adjustable Menu/LCD Functions

The following table lists the player functions that you can adjust and the options associated with each function.

Function	Options
Backlight	Adjusts the backlight on the display screen. Choices are default, always on, and always off. Default is off after 10 seconds
Play Mode	Sets the default Repeat mode. Choices are Sequential, Repeat One, Repeat All, and Shuffle. Default is Sequential.
LCD Contrast	Adjusts the contrast on the display screen. Choices are 0 through 40. Default is 32.
LCD Scroll Rate	Adjusts the speed at which you scroll through lists of items on the display screen. Choices are Slow, Medium, and Fast. Default is Medium.
Auto Shut Off	Adjusts the amount of time before the player will automatically shut off. Choices are disabled, 30 minutes, 60 minutes, 90 minutes, and so on in 30-minute increments. Default is 30 minutes.
Sort	Sets the default ID3 sort method. Choices are Title, Artist, Album, Genre, and File. Default is File to sort by file name on the disc.
Multisession	Allows you to disable the multisession function if you never use multisession CDs, speeding up load time. Choices are on and off. Default is on.
BASS	Adjusts the BASS for the User EQ setting. Choices are -10 through +10. Default is 0.
TREBLE	Adjusts the TREBLE for the User EQ setting. Choices are -10 through +10. Default is 0.
EQ	Sets the default Equalizer settings. Choices are Flat, Rock, Latin, Dance, Jazz, and User. (Changing the above BASS and TREBLE settings creates the User setting.) Default is Flat.

Using the Software

Your iPAQ Personal CD Player PCD-1 comes with a CD that contains two of the leading software packages for managing your digital audio.

- > **MusicMatch Jukebox 6.1** - Used for creating (“burning”) your data CDs as well as downloading and managing your music.
- > **Microsoft Windows Media Player 7.1** - Used for downloading and managing digital media. (Windows Media Player does not “burn” data CDs.)

Note for Microsoft XP Users: Support for creating digital music CDs is already included with your operating system. You may choose not to install the software above.

Installing the Software

To install the software, close all other programs and follow these steps:

1. Insert the CD that came with your PCD-1 into your CD-ROM or DVD drive. Installation begins and the PCD-1 Software Installation window displays.

***Tip:** If the installation does not begin automatically, click on the **Start** menu, select **Run**, and type **X:setup** (where *X* is the letter of your CD-ROM or DVD drive).*

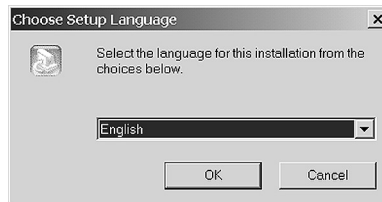

2. Select the language that you want to install first then click **OK**.
3. Follow the Setup Wizard through installation and setup.
4. Repeat the steps to install the other software package if desired.

MusicMatch Jukebox 6.1

The MusicMatch Jukebox allows you to use a single application to:

- > Record (“burn”) your own CDs.
- > Manage audio content on your PC.
- > Encode audio files (“rip”) from a CD.
- > Find music to download from the Internet.

Opening the Software

Follow these simple steps to activate MusicMatch Jukebox 6.1.

1. Double-click the MusicMatch Jukebox icon  on your desktop to activate the software.
2. The MusicMatch Jukebox window displays the following:



3. Click on **Help** at the top of the window. Select **Getting Started** from the drop-down menu.



4. Follow the easy instructions that guide you through finding music on the Internet. You will also learn how to copy and create CDs and playlists.

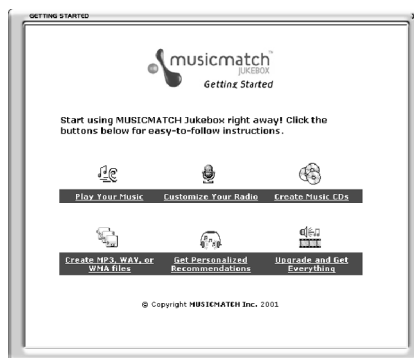

Using Windows Media Player 7.1

Windows Media Player 7.1 is included with your PCD-1 as an added feature. You may use Windows Media Player 7.1 to copy and manage music on your PC.

Note: Windows Media Player 7.1 does not burn data CDs for the PCD-1.

Windows Media Player 7.1 features an integrated Media Guide with content from www.windowsmedia.com, a radio tuner, CD copying, multiple skins (screen designs), and much more.

To activate the Windows Media Player 7.1 software, complete the following steps:

1. Double-click the **Windows Media Player** icon on your desktop to activate the software. The **Windows Media Player** displays.



2. Click on **Help** at the top of the window. Select **Help Topics** from the drop-down menu.



3. The window opens to **Getting Started**. Follow the easy instructions that guide you through copying and playing CDs.



Troubleshooting

Symptom	What to do
Nothing shows on the display when the Power button is pressed.	<ul style="list-style-type: none"> > Make sure the batteries are installed. > Install fresh batteries. > Make sure the power adapter is plugged into the proper connection.
The LCD backlight does not illuminate when a button is pressed.	<ul style="list-style-type: none"> > The backlight may not be visible in bright light. Check in a dark environment. > Check the Menu setting to make sure the backlight is turned on.
"NO DISC" is displayed on the LCD.	<ul style="list-style-type: none"> > Insert a CD. > Check to ensure that the CD is properly installed. The CD must be snapped all the way down into place with the correct side facing up. > CD is badly scratched or dirty. Replace or clean the CD.
"Hold is on!" is displayed on the LCD.	Displays when attempting to turn on the PCD-1 when the Norm/Hold switch on the side of the player is in the Hold position. Slide this switch to the Norm position before turning on the PCD-1.
Player turns on then shuts off.	Check to make sure the Norm/Hold switch is in the Norm position before turning on the PCD-1.
No sound.	<ul style="list-style-type: none"> > Make sure the Play/Pause icon on the LCD is solid. A flashing elapsed time indicates Pause mode. Press the Play/Pause button. > Increase the volume level by pressing the Volume Increase button. > Make sure the headphones are properly attached. > Look for a song title on the LCD display. > If the player is in Radio mode, make sure a radio station is tuned in.
No sound in one headphone.	<ul style="list-style-type: none"> > Make sure the headphone connector is fully inserted into the connector on the PCD-1. > Use another set of headphones (if available).
Remote control does not work.	<ul style="list-style-type: none"> > Make sure the PCD-1 power is on. > Install or replace the battery in the remote control.

Helpful Information

Maintenance

Use only a soft, dry cloth to clean your PCD-1 CD Player. Keep the inside free of any foreign material.

Precautions

- > Do not remove the batteries while operating the unit.
- > Do not expose the unit to a significant amount of moisture.
- > Do not store the unit in a place in which the temperature will exceed 50 degrees C or will be less than -10 degrees C (120°F to 15°F).
- > Use of headphones while operating a vehicle is not recommended. Stop operation of the player if you find it disruptive or distracting while operating any type of vehicle.
- > Never mix rechargeable and non-rechargeable batteries.

FCC Compliance

This device complies with Part 15 of the FCC Rules. Operation is subject to the following conditions:

1. This device may not cause harmful interference, and
2. This device must accept any interference received, including interference that may cause undesired operation.

CAUTION: Changes or modifications not expressly approved by Compaq may void the user's authority to operate this equipment.

Note: This equipment has been tested and found to comply with the limits for a Class B digital device, pursuant to Part 15 of the FCC Rules. These limits are designed to provide reasonable protection against harmful interference in a residential installation. This equipment generates, uses, and can radiate radio frequency energy, and if not installed and used in accordance with the instructions, may cause harmful interference to radio communications. However, there is no guarantee that interference will not occur in a particular installation. If this equipment does cause harmful interference to radio or television reception (which can be determined by turning the equipment off and on) the user is encouraged to try to correct the interference by one or more of the following measures:

- > Reorient or relocate the receiving antenna.
- > Increase the separation between the equipment and receiver.
- > Connect the equipment into an outlet on a circuit different from that to which the receiver is connected.
- > Consult the dealer or an experienced radio/TV technician for help.

Specifications

Casing: Metallic cover and high-impact plastic body

Dimensions: 5.8" x 5.1" x 1.4"

Weight: 12.7 ounces (with batteries)

Display: LCD with backlight

Power Source: 2 AA Ni-MH rechargeable batteries or AC adapter

Signal to noise ratio: >85dB

Frequency Response: 20 Hz to 20 kHz

Operation Temperature: -10 degrees C to 50 degrees C (15°F to 120°F)

Harmonic Distortion: 0.1%

Format Support: MP3, WMA, and CD-DA

Software: MusicMatch Jukebox 6.1; Windows Media Player 7.1

Upgradeability: Software upgrades via the Internet

