

BRAUN

HS 3



Independent[®] Power Brush

Type 3585

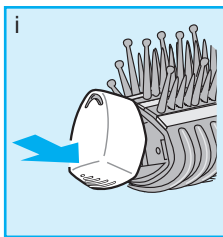
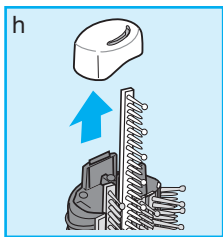
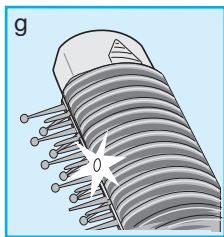
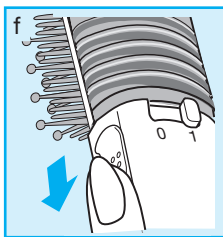
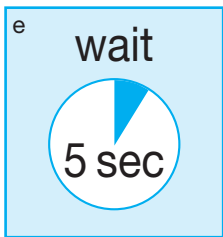
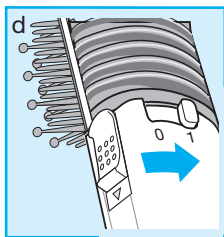
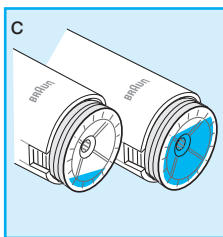
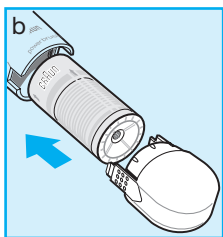
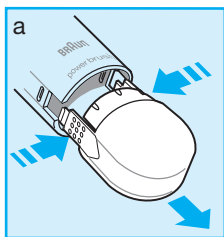
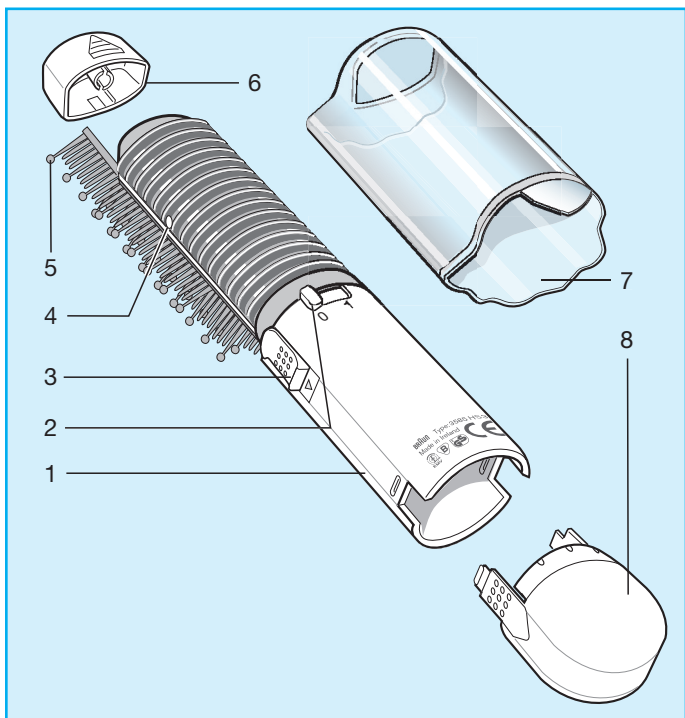

Our products are engineered to meet the highest standards of quality, functionality and design. We hope you thoroughly enjoy your new Braun appliance.

Caution

- Do not expose to temperatures of more than 50°C (e.g. glove compartment of cars), nor direct sunlight for long periods of time.
 - Keep out of the reach of children.
 - Do not allow the appliance to become wet.
 - When starting the appliance please ensure that it is held away from the hair, face and clothing. Do not start the appliance while it is in the hair in order to avoid damage to the hair. Energy cell contains flammable butane gas under pressure.
 - Keep away from flames (burning cigarettes as well).
 - Use Braun energy cells only.
 - Avoid touching the hot parts of the product.
 - When hot, do not place on surfaces which are not heat resistant.
 - Do not take apart, puncture or incinerate.
 - If the appliance is damaged, stop using it immediately. For repairs refer to authorised Braun Service Agents only.
-

The Braun Independent Power Brush should be used on dry hair only. It is designed to smooth and shape your hair.

Description

- ① Handle
- ② Switch for gas supply (0 = off, 1 = on)
- ③ Ignition switch
- ④ On/ready indicator
- ⑤ Comb lines
- ⑥ End cover for comb lines
- ⑦ Protective cover
- ⑧ End cap

Inserting or exchanging the Braun energy cell

(Never insert or exchange it near an open fire or flame.)

- The switch ② must be set at the «0» (= off) position.
- Press the textured buttons on end cap ⑧ and pull it off (a).
- Insert the Braun energy cell into the handle (b).
Important: The arrows on the energy cell indicate which way it should be inserted.
- Push the cell firmly up into the handle. Replace the end cap until the hooks on the handle lock.

Use only Braun energy cells CTS (12.5 ml/7 g) which are specially designed for this appliance. They are available from the store where your Braun Independent Power Brush was purchased, as well as from authorised Braun Service Agents. The energy cells can be changed at any time, even if they are only partly filled.

How to use

- Before each use check the gas level ③. To do so, remove the end cap ⑧. Change the energy cell when empty (see instructions).
- To aid ignition, hold the product upright. Turn on the gas flow by setting the switch ② to the «1» position ④. **Wait 5 seconds** ⑤.
- Pull the ignition switch back until you hear an audible «click» ⑥. The on/ready indicator ④ will then light up, confirming that the heating system is on ⑨.
- The appliance heats up fast and after approximately 90 seconds the on/ready indicator will turn off: the appliance has reached the optimal styling temperature and is now ready for use. A thermostat maintains the optimal styling temperature. The «ready» indicator may flash briefly during styling, whenever the appliance is heated up again to maintain a constant temperature.

When you have finished styling

- Turn off the Braun Independent Power Brush by moving the switch ② to the «0» position and push the protective cover ⑦ on the appliance as far as it will go. The heat resistant protective cover can be placed on the brush, even if the product is still hot.

Cleaning

Make sure the appliance is switched off and cold.

For cleaning, remove the end cover ⑥ and pull off the comb lines ⑧. Immerse all removed parts in warm soapy water for a few minutes. Clean them with a brush, rinse and dry. After cleaning, push the comb lines back onto the Braun Independent Power Brush. To lock the comb lines, push back the cover ⑩, first on the slit and then the opposite side against the direction of the arrow, until it locks. The handle ① and the protective cover ⑦ may only be wiped with a soft damp cloth.

Never immerse the appliance in water.

Subject to change without notice.



This product conforms to the EMC-Requirements as laid down by the Council Directive 89/336/EEC.

Styling instructions

The Braun Independent Power Brush is a combination of heated brush and shaper making it an ideal styling tool in your handbag for on-the-spot styling. It is a new way to style, shape and fine-tune your hairstyle also after it has been dried and between washes. Cordless and compact, it is designed to fit comfortably in your hand, giving you close-up control.

Step by step

- 1 Use the Braun Independent Power Brush with a slow, firm brushing action to smooth and control hair. The brush has long plastic bristles with rounded tips to protect your scalp while the heated surface gives the smoothing effect.
- 2 After 4-5 brushing strokes on a section of hair, that section is ready to be shaped to add movement and direction.
- 3 To shape the hair, simply draw the brush through the hair to the ends. Turn the brush half a turn. Hold for a few seconds to allow the heated metal shaping edge to set shape.

For best results

To ensure smoother, non-frizzy and shinier results, the Independent Power Brush should be drawn through the hair slowly. When shaping hair, gently unwind and then leave the hair to cool for a second or two before brushing out your section of hair. This helps to hold the style.

Guarantee

We grant 2 years guarantee on the product commencing on the date of purchase. Within the guarantee period we will eliminate, free of charge, any defects in the appliance resulting from faults in materials or workmanship, either by repairing or replacing the complete appliance as we may choose.

This guarantee extends to every country where this appliance is supplied by Braun or its appointed distributor.

This guarantee does not cover: damage due to improper use, normal wear or use as well as defects that have a negligible effect on the value or operation of the appliance. The guarantee becomes void if repairs are undertaken by unauthorised persons and if original Braun parts are not used.

To obtain service within the guarantee period, hand in or send the complete appliance with your sales receipt to an authorised Braun Customer Service Centre.

For UK only:

This guarantee in no way affects your rights under statutory law.



Consumer Helpline:

Should you require any further assistance, please call Braun (UK) Consumer Relations on

GB 0800 783 70 10

IRL 1 800 509-448

Internet:

www.braun.com



When travelling by air, please note that no more than one appliance may be carried by each crew member or passenger aboard an aircraft in checked luggage, if the protective cover is secured over the heating element. Separate gas refills are not permitted.