



Please keep this instruction sheet for future reference,
as it contains important information.

Requires three "D" (LR20) **alkaline** batteries for mobile
operation and two "AAA" (LR03) **alkaline** batteries for
remote operation (batteries not included).

Adult assembly is required.

Tool required for assembly: Phillips screwdriver (not included).

Consumer Information



WARNING

Prevent Entanglement Injury

- Keep mobile out of baby's reach.
- Remove mobile portion of product from crib or playpen when baby begins to push up on hands and knees.
- This product may not attach to all crib designs. Do not add additional strings or straps to attach to crib or playpen.
- Use **ONLY** attached to a crib or playpen.

IMPORTANT! Always attach with all provided fasteners tightly to a crib or playpen according to the instructions. Do not add additional strings or straps to attach to a crib. Check frequently.

- The mobile portion of this product may be used from birth until 5 months.
- The base portion of this product may be used from birth until 36 months.
- A crib mobile is intended for visual stimulation and is not to be grasped by a child.
- Wipe this toy with a clean cloth dampened with a mild soap and water solution. Do not immerse this toy. The soft toys are surface washable.
- This toy has no consumer serviceable parts. Do not take this toy apart.
- If this product begins to operate erratically, you may need to reset the electronics. Slide the power/volume switch on the mobile base off and then back on. Remove the batteries from the remote and replace them.



- Protect the environment by not disposing of this product with household waste (2002/96/EC). Check your local authority for recycling advice and facilities (Europe only).

Battery Safety Information

In exceptional circumstances, batteries may leak fluids that can cause a chemical burn injury or ruin your product. To avoid battery leakage:

- Do not mix old and new batteries or batteries of different types: alkaline, standard (carbon-zinc) or rechargeable (nickel-cadmium).
- Insert batteries as indicated inside the battery compartment.
- Remove batteries during long periods of non-use. Always remove exhausted batteries from the product. Dispose of batteries safely. Do not dispose of product in a fire. The batteries inside may explode or leak.
- Never short-circuit the battery terminals.
- Use only batteries of the same or equivalent type, as recommended.
- Do not charge non-rechargeable batteries.
- Remove rechargeable batteries from the product before charging.
- If removable, rechargeable batteries are used, they are only to be charged under adult supervision.

Parts

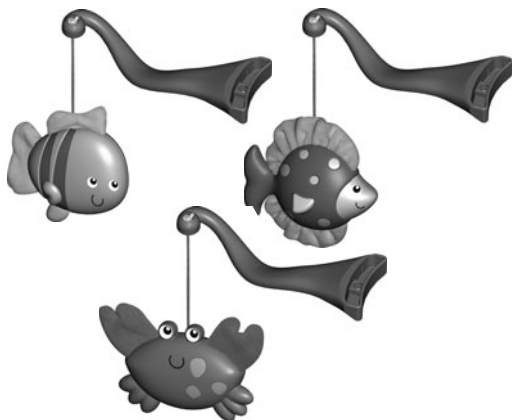

3 Long Spokes



3 Short Spokes



Crib Connector



Remote



Mobile Hub



Arm



Base

Note: All of the screws used to assemble this toy are attached to the product. Follow these instructions carefully to fully secure the screws. Tighten and loosen all screws with a Phillips screwdriver. Do not over-tighten the screws.

Battery Installation

*Hint: We recommend using **alkaline** batteries for longer battery life.*

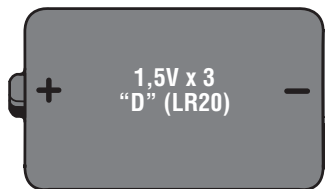

Mobile Base

- Loosen the screws in the battery compartment door with a Phillips screwdriver. Remove the battery compartment door.
- Insert three "D" (LR20) **alkaline** batteries.
- Replace the battery compartment door and tighten the screws.

IMPORTANT! Under normal use conditions, the batteries in the mobile base will require replacement more often than the batteries in the remote. When sounds or lights become faint or stop, it's time for an adult to change the batteries.



Remote

- Loosen the screw in the battery compartment door with a Phillips screwdriver. Remove the battery compartment door.
- Insert two "AAA" (LR03) **alkaline** batteries.
- Replace the battery compartment door and tighten the screw.

Assembly

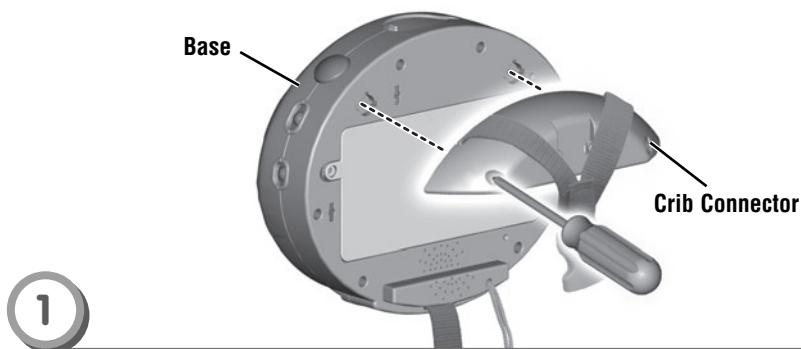

- Fit the crib connector to the base and tighten **both** screws.
- IMPORTANT!** Make sure the straps are over the **top** of the crib connector.

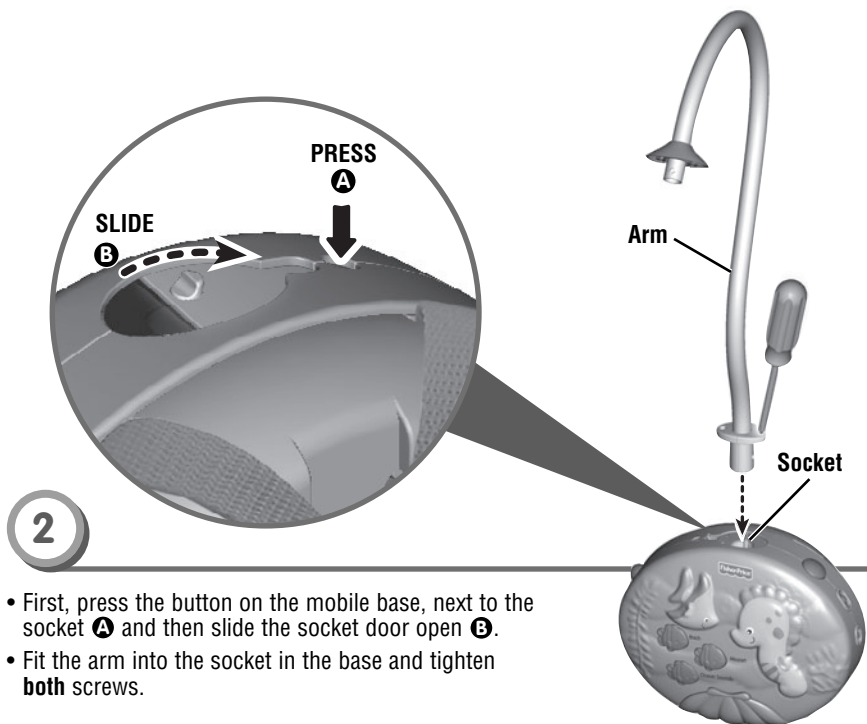

- First, press the button on the mobile base, next to the socket **A** and then slide the socket door open **B**.
- Fit the arm into the socket in the base and tighten **both** screws.

Assembly

3

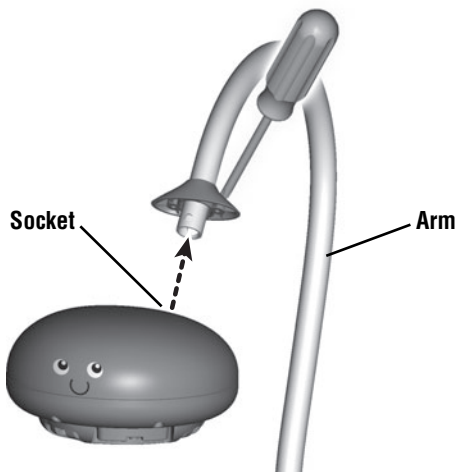

- Fit the end of the arm to the socket on the mobile hub.
- Tighten **both screws** in the arm to secure the mobile hub.

4

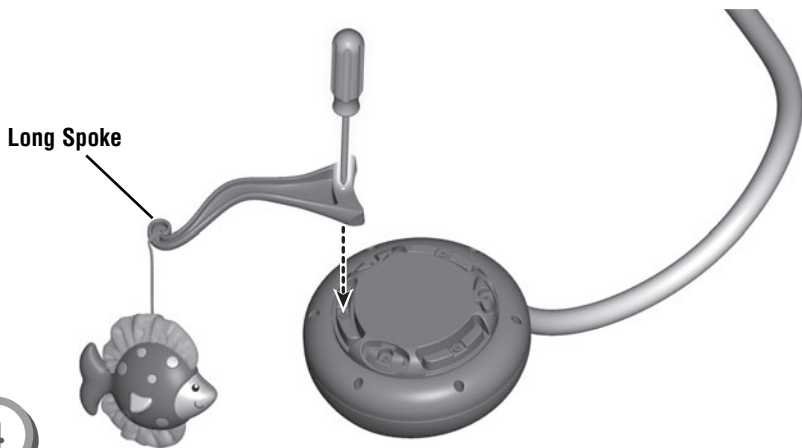

- Attach a long spoke to the mobile hub, as shown.
- Tighten the screw in the long spoke.
- Repeat this procedure to attach the remaining long spokes to the mobile hub.

Assembly

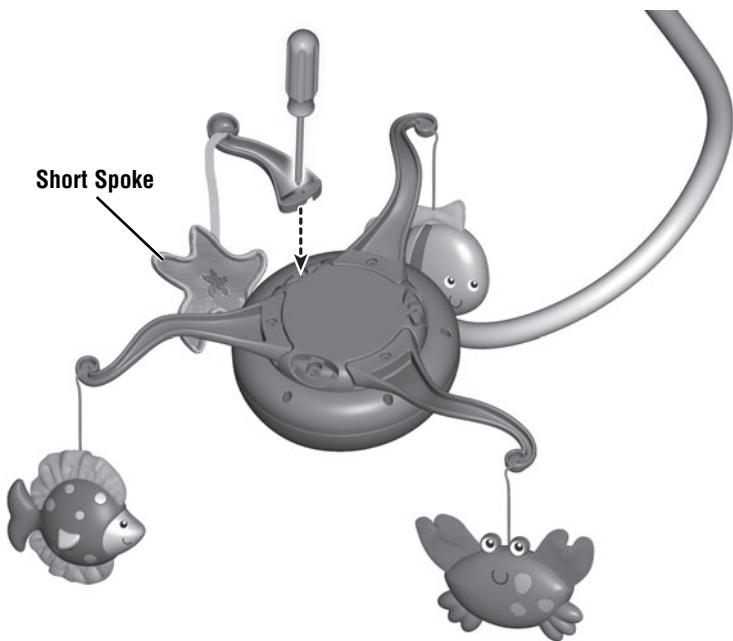

5

- Attach a short spoke to the mobile hub, as shown.
- Tighten the screw in the short spoke.
- Repeat this procedure to attach the remaining short spokes to the mobile hub.

Consumer Information

**CONSUMER ASSISTANCE**
1-800-432-5437 (US & Canada)
1300 135 312 (Australia)
service.fisher-price.com
Fisher-Price, Inc., 636 Girard Avenue, East Aurora, NY 14052.
Hearing-impaired consumers: 1-800-382-7470.
Outside the United States:
Canada: Mattel Canada Inc., 6155 Freemont Blvd.,
Mississauga, Ontario L5R 3W2; www.service.mattel.com.
Great Britain: Mattel UK Ltd, Vanwall Business Park,
Maidenhead SL6 4UB. Helpline: 01628 500303.
www.service.mattel.com/uk
Mattel Europa, B.V., Gondel 1, 1186 MJ Amstelveen, Nederland.
Australia: Mattel Australia Pty. Ltd., 658 Church Street,
Locked Bag #870, Richmond, Victoria 3121 Australia.
New Zealand: 16-18 William Pickering Drive,
Albany 1331, Auckland.

FCC Statement (United States Only)

This equipment has been tested and found to comply with the limits for a Class B digital device, pursuant to Part 15 of the FCC Rules. These limits are designed to provide reasonable protection against harmful interference in a residential installation. This equipment generates, uses and can radiate radio frequency energy and, if not installed and used in accordance with the instructions, may cause harmful interference to radio communications. However, there is no guarantee that interference will not occur in a particular installation. If this equipment does cause harmful interference to radio or television reception, which can be determined by turning the equipment off and on, the user is encouraged to try to correct the interference by one or more of the following measures:

- Reorient or relocate the receiving antenna.
- Increase the separation between the equipment and receiver.
- Consult the dealer or an experienced radio/TV technician for help.

Note: Changes or modifications not expressly approved by the manufacturer responsible for compliance could void the user's authority to operate the equipment.

This device complies with Part 15 of the FCC Rules. Operation is subject to the following two conditions: (1) this device may not cause harmful interference and (2) this device must accept any interference received, including interference that may cause undesired operation.

ICES-003

This Class B digital apparatus complies with Canadian ICES-003.

Operation is subject to the following two conditions: (1) this device may not cause harmful interference and (2) this device must accept any interference received, including interference that may cause undesired operation.

NMB-003

Cet appareil numérique de la classe B est conforme à la norme NMB-003 du Canada.

L'utilisation de ce dispositif est autorisée seulement aux conditions suivantes:

(1) il ne doit pas produire de brouillage et
(2) l'utilisateur du dispositif doit être prêt à accepter tout brouillage radioélectrique reçu, même si ce brouillage est susceptible de compromettre le fonctionnement du dispositif.

Crib Attachment



WARNING

Prevent Entanglement Injury

- Keep mobile out of baby's reach.
- Remove mobile portion of product from crib or playpen when baby begins to push up on hands and knees.
- This product may not attach to all crib designs. Do not add additional strings or straps to attach to crib or playpen.
- Use **ONLY** attached to a crib or playpen.

IMPORTANT! If you are attaching this toy to a crib side rail that can be lowered and raised, make sure the crib side rail is in the raised (locked) position whenever a child is in the crib.

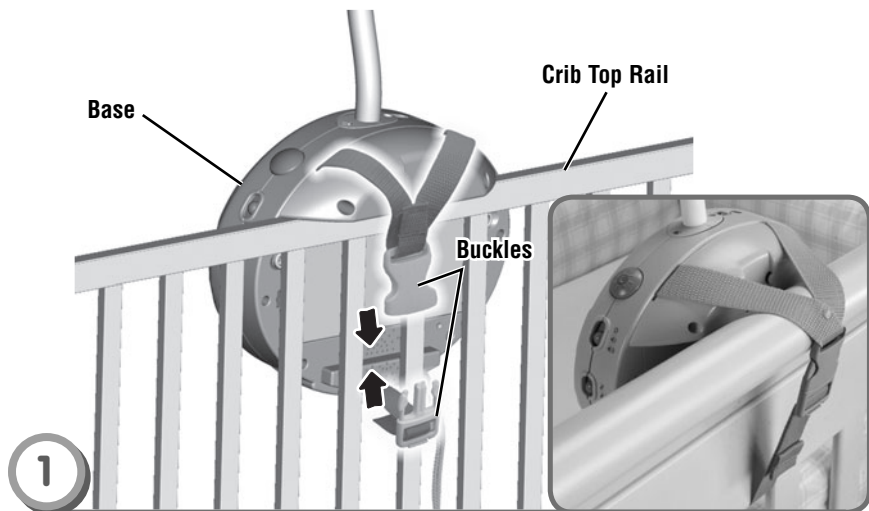

- Position the base so that the decorated side faces the inside of the crib.
- Fit the base onto the crib top rail.

Hint: The base is designed to fit most crib designs. Please refer to the main illustration and the inset photograph.

- Make sure the top strap is hanging over the crib top rail. Pull the bottom strap through the crib rails.
- Buckle the straps. Make sure you hear a “click”.

Crib Attachment

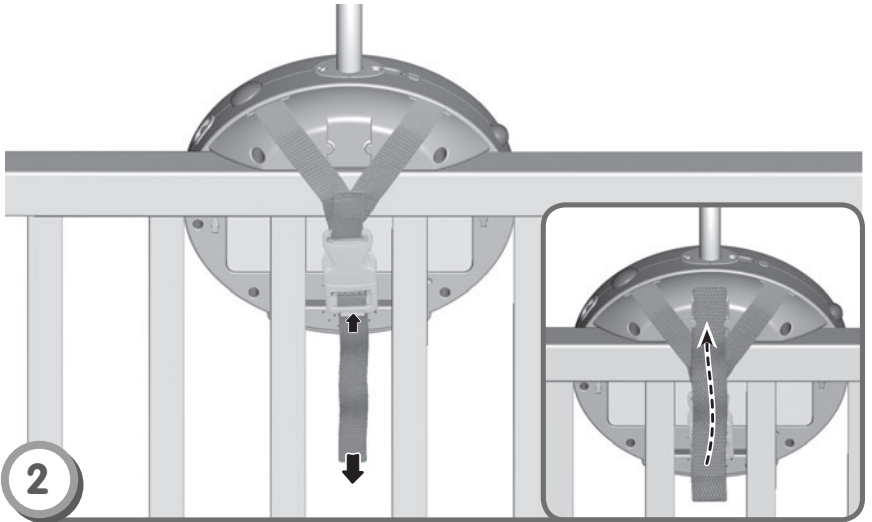

- Make sure the straps are tightened securely around the crib rail.
- While pushing the tab at the bottom of the buckle, pull the free end of the strap to tighten on the rail.

Hint: You can secure the free end of the strap to the base.

Crib Attachment

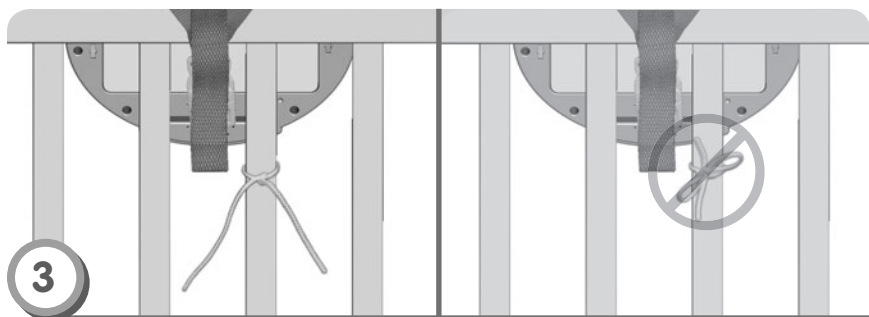

- Tie the base strings to a crib spindle.

Note: It is better to tie the strings in a knot than a bow, since a bow may be easily untied.

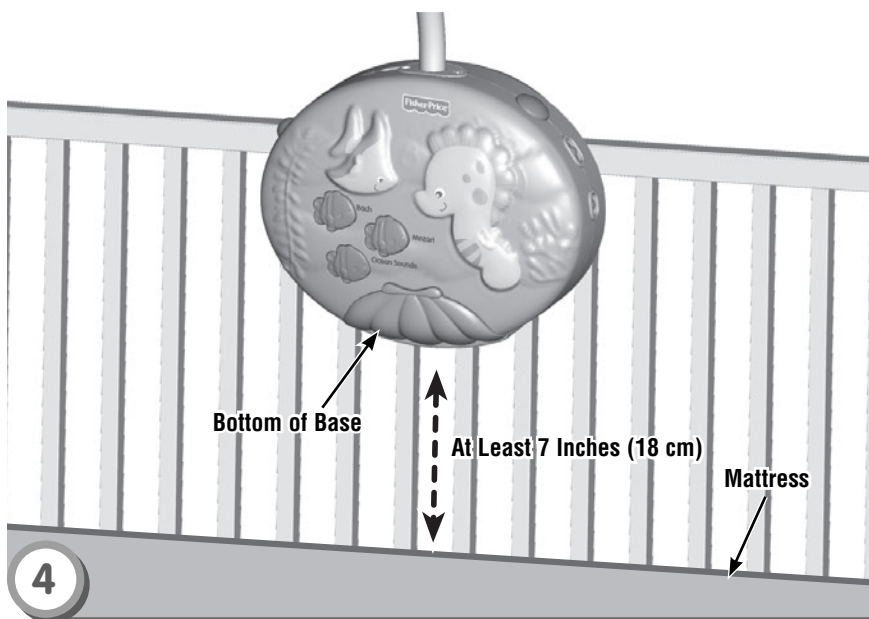

- If the distance between the base and the mattress is less than 7 Inches (18 cm), lower the crib mattress.

Use

IMPORTANT!

- In the unlikely event that use of the remote interferes with normal use of other remote controlled equipment, such as televisions, stereos, or use of other electronic or battery powered appliances interfere with operation of the mobile, do not use both appliances at the same time.
- For best performance between the mobile and the remote, avoid using the remote in areas of bright light. In bright natural or artificial light, you may notice loss of range. Move the mobile or otherwise reduce the amount of light to improve performance.

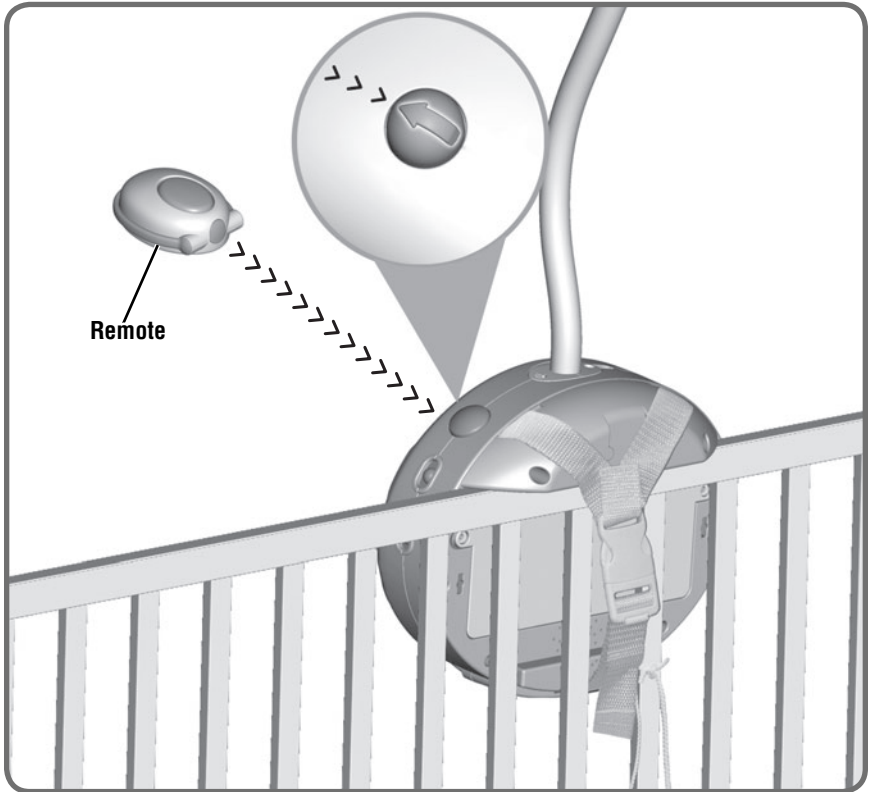

- When using the remote, make sure that the arrow on the mobile base is pointing towards the transmitter window on the remote. **For best results make sure the path between the transmitter window on the remote and the mobile base are in a direct line and free of obstacles. Position the mobile base so that the arrow points to the area from which you're most likely to use the remote.**

Use

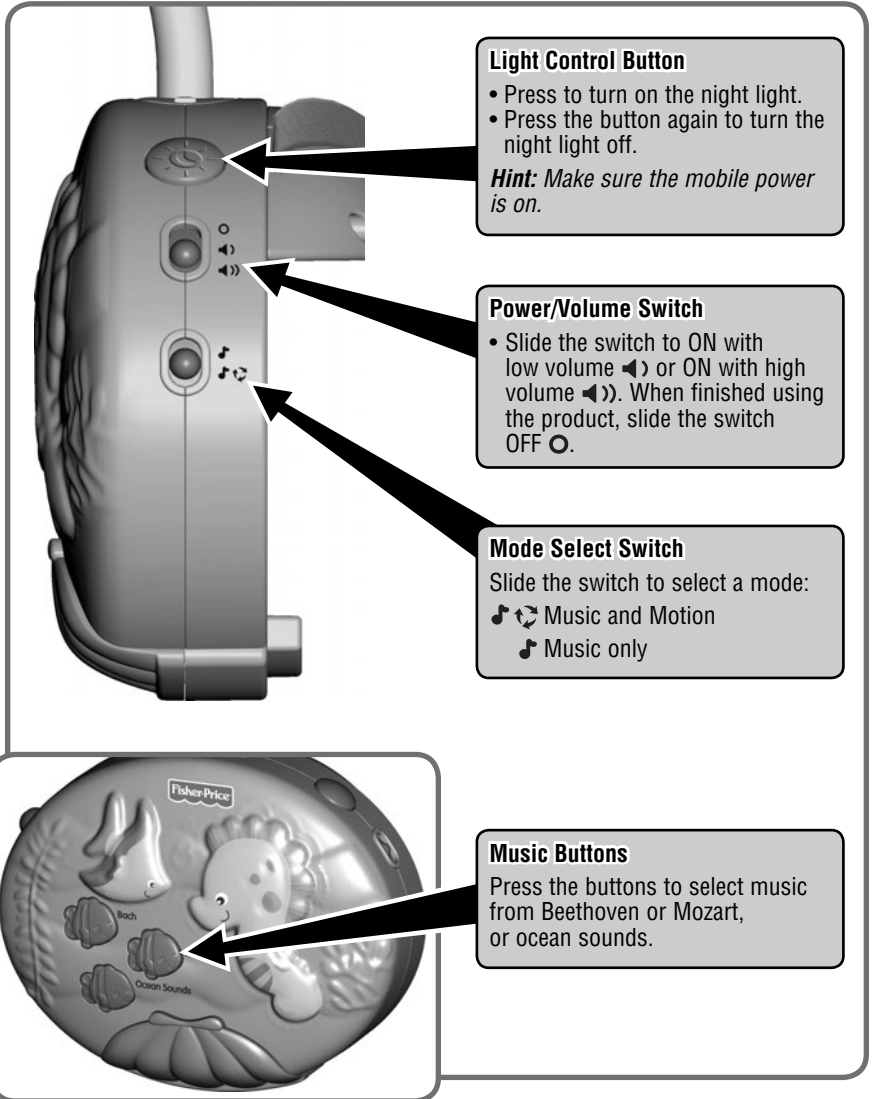

Convert to Night Light

Remove the mobile and use as a music box with a night light!



- Loosen both screws in the arm near the mobile base. Lift and remove the arm.
- Close the socket door on top of the mobile base.
- Store the mobile in a safe place for future use.