

Clarion

Owner's manual
Mode d'emploi
Bedienungsanleitung
Istruzioni per l'uso
Gebruiksaanwijzing
Manual de instrucciones
Bruksanvisning
Manual de instruções

DB538RMP

AM/FM MP3 CD PLAYER

RADIO AM/FM-LECTEUR CD/MP3

AM/UKW MP3 CD-SPIELER

SINTOLETTORE CD MP3 AM/FM

AM/FM MP3 CD-SPELER

REPRODUCTOR DE AM/FM CD/MP3

AM/FM-RADIO OCH CD/MP3-SPELARE

COMBINAÇÃO DE RÁDIO AM/FM, LEITOR
DE CDs e MP3

COMPACT
disc
DIGITAL AUDIO

R-D-S
EON

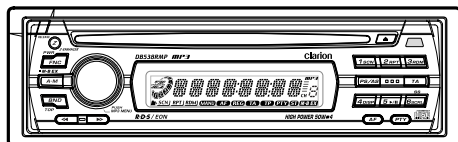

Thank you for purchasing this **Clarion** product.

- * Please read this owner's manual in its entirety before operating this equipment.
- * After reading this manual, be sure to keep it in a handy place (e.g., glove compartment).
- * Check the contents of the enclosed warranty card and keep it carefully with this manual.

CAUTIONS:

This appliance contains a laser system and is classified as a "CLASS 1 LASER PRODUCT". To use this model properly, read this Owner's Manual carefully and keep this manual for your future reference. In case of any trouble with this player, please contact your nearest "AUTHORIZED service station". To prevent direct exposure to the laser beam, do not try to open the enclosure.

!CAUTION

USE OF CONTROLS OR ADJUSTMENTS OR PERFORMANCE OF PROCEDURES OTHER THAN THOSE SPECIFIED IN THE OWNER'S MANUAL MAY RESULT IN HAZARDOUS RADIATION EXPOSURE.

ADVARSEL.

Denne mærking er anbragt udvendigt på apparatet og indikerer, at apparatet arbejder med laserstråler af klasse 1, hvilket betyder, at der anvendes laserstråler af svageste klasse, og at man ikke på apparatets yderside kan blive udsat for utilladelig kraftig stråling.

APPARATET BØR KUN ÅBNES AF FAGFOLK MED SÆRLIGT KENDSKAB TIL APPARATER MED LASERSTRÅLER!

Indvendigt i apparatet er anbragt den her gengivne advarselsmærkning, som advarer imod at foretage sådanne indgreb i apparatet, at man kan komme til at udsætte sig for laserstråling.

OBS!

Apparatet innehåller laserkomponenten som avger laserstråling överstigande gränsen för laserklass 1.

VAROITUS

Suojakoteloä si saa avata. Laite sisältää laseriodin, joka lähettää näkymätöntä silmille vaarallista lasersäteilyä.

MODEL	DB538RMP	clarion
12V ⚡ GROUND		
LW	153-279kHz	e13 021477
MW	531-1602kHz	
FM(UKW)	87.5-108MHz	EMCTYPE 542310
This unit is designed for on-road vehicle purpose.		
CLASS 1 LASER PRODUCT		
<small>PE-2604E 286-9997-00 Clarion Co., Ltd. MADE IN MALAYSIA</small>		

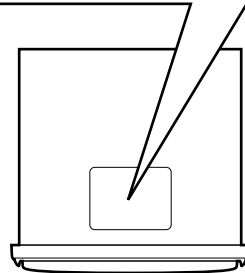

Contents

1. PRECAUTIONS	3
Handling Compact Discs	4
2. CONTROLS	5
3. NOMENCLATURE	6
Names of the Buttons and their Functions	6
Display Items	7
LCD Screen	7
4. REMOTE CONTROL (Optional Item)	8
5. DCP	10
6. OPERATIONS	11
Basic Operations	11
Radio Operations	13
RDS Operations	15
CD/MP3 Mode Operations	18
MP3 Special Function Menu	19
7. IN CASE OF DIFFICULTY	23
8. ERROR DISPLAYS	24
9. SPECIFICATIONS	25

1. PRECAUTIONS

1. This unit is applicable for on-road 4 wheel vehicle purpose only. Use for tractor, fork truck, bulldozer, off road vehicle, 2 or 3 wheel motor bicycle, marine boat or other special purpose vehicle is not appropriate.
2. When the inside of the car is very cold and the player is used soon after switching on the heater moisture may form on the disc or the optical parts of the player and proper playback may not be possible. If moisture forms on the disc, wipe it off with a soft cloth. If moisture forms on the optical parts of the player, do not use the player for about one hour. The condensation will disappear naturally allowing normal operation.
3. Driving on extremely bumpy roads which cause severe vibration may cause the sound to skip.

INFORMATION FOR USERS:

CHANGES OR MODIFICATIONS TO THIS PRODUCT NOT APPROVED BY THE MANUFACTURER WILL VOID THE WARRANTY.

Handling Compact Discs

This unit has been designed specifically for playback of compact discs bearing the  mark. No other discs can be played.

To remove the compact disc from its storage case, press down on the centre of the case and lift the disc out, holding it carefully by the edges.

Removing the disc

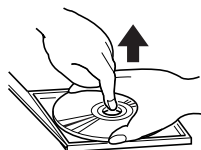

Proper way to hold the compact disc



Always handle the compact disc by the edges. Never touch the surface.

To remove fingermarks and dust, use a soft cloth, and wipe in a straight line from the centre of the compact disc to the circumference.

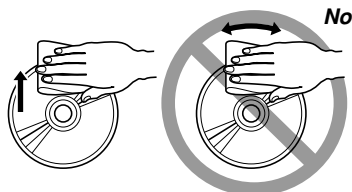

New discs may have some roughness around the edges. The unit may not work or the sound may skip if such discs are used. Use a ball-point pen, etc. to remove roughness from the edge of the disc.

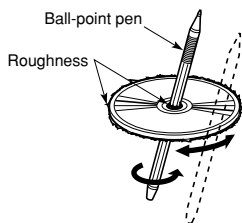

Note on Compact Discs

Never stick labels on the surface of the compact disc or mark the surface with a pencil or pen.

No

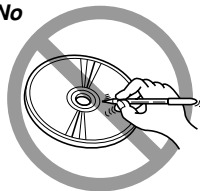

Do not use any solvents such as commercially available cleaners, anti-static spray, or thinner to clean compact discs.

No

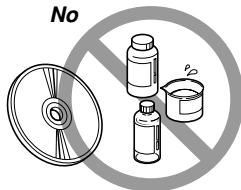

Do not use compact discs that have large scratches, are misshapen, or cracked, etc. Use of such discs will cause misoperation or damage.

No

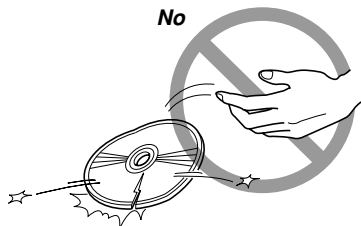

Do not expose compact discs to direct sunlight or any heat source.

No

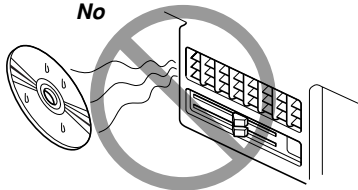

Note:

- Do not use commercially available CD protection sheets or discs equipped with stabilizers, etc. These may get caught in the internal mechanism and damage the disc.

*Be sure to unfold and read the next page. / Veuillez déplier et vous référer à la page suivante.
Bitte ausbreiten und die nächste Seite lesen. / Assicurarsi di aprire e leggere la pagina successiva.
Volgende pagina uitvouwen en doorlezen a.u.b. / Cerciórese de desplegar y de leer la página siguiente.
Glöm inte att vika ut och läsa nästa sida. / Não deixe de abrir e ler a próxima página.*



2. CONTROLS / LES COMMANDES / REGLER / CONTROLLI REGELAARS / CONTROLES / KONTROLLER / CONTROLOS

*Main unit / Appareil principal / Hauptgerät / Apparechio principale
Hoofdtoestel / Unidad principal / Huvudenhet / Unidade principal*

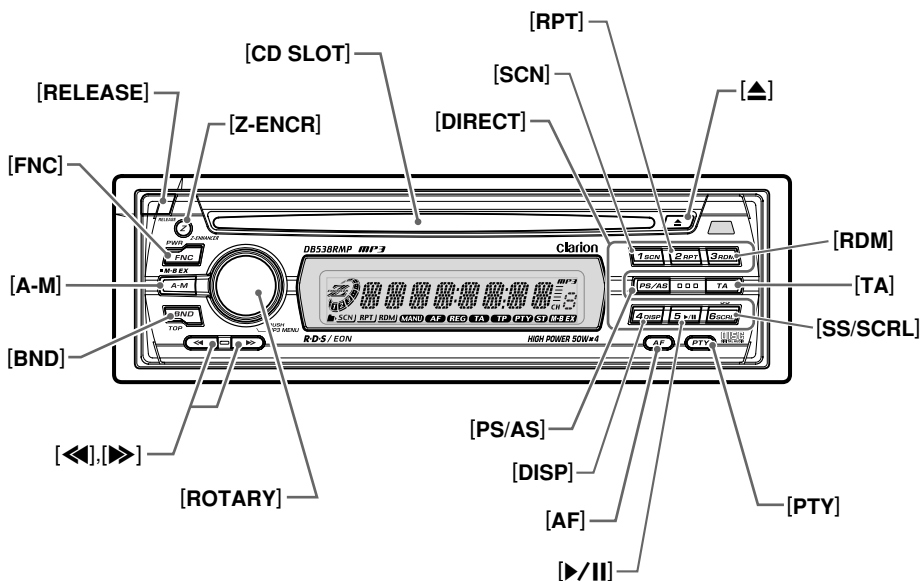

Note: Be sure to unfold this page and refer to the front diagrams as you read each chapter.

Remarque: Veuillez déplier cette page et vous référer aux schémas quand vous lisez chaque chapitre.

Hinweis: Bitte diese Seite ausfalten und beim Lesen der einzelnen Kapitel die Frontdiagramme beachten.

Nota: Assicurarvi di aprire questa pagina e fare riferimento a questi diagrammi quando si legge ciascun capitolo.

Opmerking: Vouw deze pagina uit en zie tevens de afbeeldingen van het voorpaneel tijdens het doorlezen van de volgende hoofdstukken.

Nota: Cuando lea los capítulos, despliegue esta página y consulte los diagramas.

Observera: Vik ut denna sida för att kunna se figurerna över bilstereons framsida medan du läser de olika kapitlen.

Nota: Certifique-se de abrir esta página e consulte os diagramas frontais conforme realiza a leitura de cada capítulo.

3. NOMENCLATURE

Note:

- Be sure to read this chapter referring to the front diagrams of chapter "2. CONTROLS" on page 5 (unfold).

Names of the Buttons and their Functions

[FNC] button

- Press the button to turn on the power.
Press and hold the button for 1second or longer to turn off the power.
- Switches the operation mode among the radio mode, etc.

[RELEASE] button

- Press the [RELEASE] button to unlock the DCP.

[Z-ENCR] button

- Use the button to select one of the three types of sound characteristics already stored in memory. (Z-Enhancer)

[CD SLOT]

- CD insertion slot.

[DIRECT] button

- Stores a station into memory or recall it directly while in the radio mode.

[SCN] button

- Performs scan play for 10 seconds for each track while in the CD mode.

[RPT] button

- Plays repeatedly while in the CD mode.

[▲] button

- Ejects a CD when it is loaded into the unit.

[RDM] button

- Performs random play while in the CD mode.

[TA] button

- Use the button to set the TA (Traffic Announcement) standby mode.

[SS/SCRL] button

- Press the [SS/SCRL] button while keeping the [BND] button pressed, to turn the screen saver function on or off.
- (MP3 Function) Press the [SS/SCRL] button to scroll display which is more than 8 characters at Title Display.

[PTY] button

- Use the button to set the PTY (Programme Type) standby mode or PTY items.

[▶/||] button

- Plays or pauses a CD while in the CD mode.

[AF] button

- Press the button to turn on or off the AF (Alternative Frequency) function.
- When the button is pressed and held, Regional function can select ON or OFF.

[DISP] button

- Press the [DISP] button while keeping the [BND] button pressed, to switch the display indication (Main display, clock display).

MP3 Function-DISPLAY SELECTION

- Press the [DISP] button (MP3 mode). Each time you press the [DISP] button, the display changes in the following order:
Track No. / Play time → Folder No. / Track No. → Title Display → Track No. / Play time...

[PS/AS] button

- Performs preset scan while in the radio mode. When the button is pressed and held, auto store is performed.

[ROTARY] knob

- Adjust the volume by turning the knob clockwise or counterclockwise.
- Use the knob to perform various settings.

[◀], [▶] button

- Selects a station while in the radio mode or selects a track when listening to a CD.
- Press and hold the button for 1 second or longer to switches the fast-forward/fast-backward.

[BND] button

- Switches the band, or seek tuning or manual tuning while in the radio mode.
- Plays a first track while in the CD mode.

[A-M] button

- Press and hold the button for 1 second or longer to switch the MAGNA BASS EX on/off.
- Use the button to switch to the audio mode (bass/treble, balance/fader)

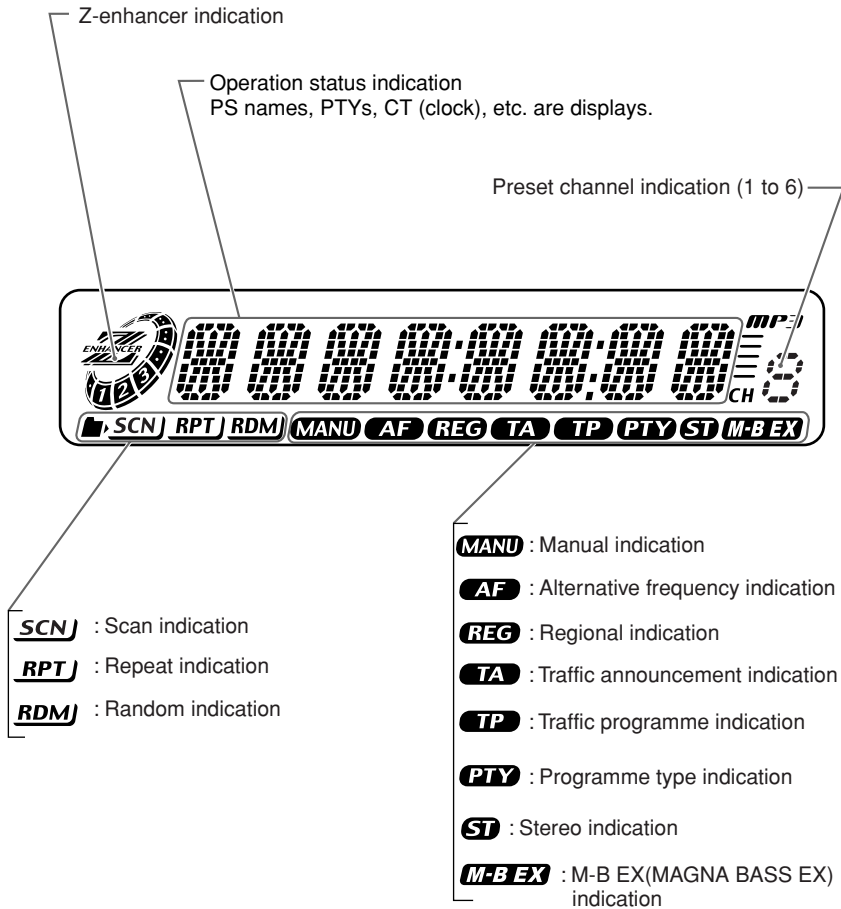

LCD Screen

In extreme cold, the screen movement may slow down and the screen may darken, but this is normal. The screen will recover when it returns to normal temperature.

4. REMOTE CONTROL (Optional Item)

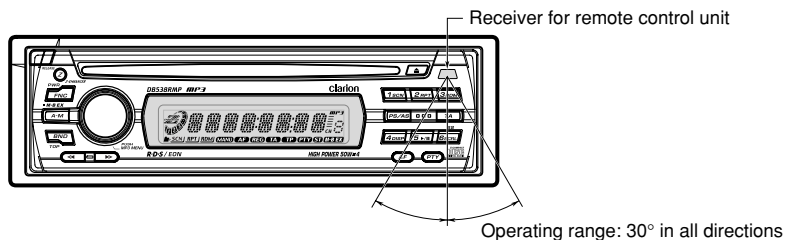

Remote control unit

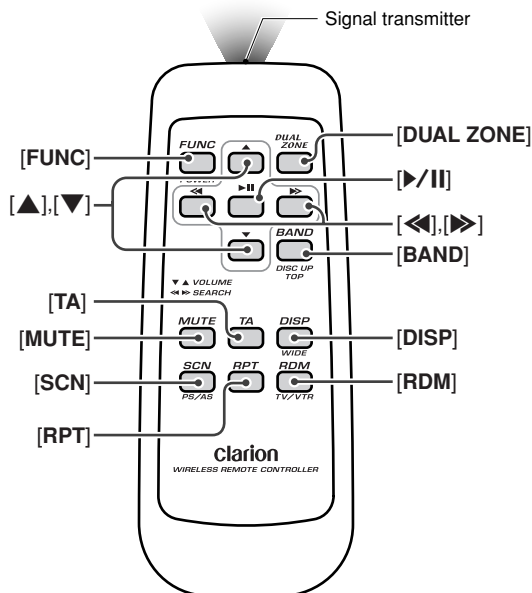

Inserting the Batteries

1. Turn the remote control unit over, then slide the rear cover in the direction of the arrow.
2. Insert the AA (SUM-3, IECR-6/1.5V) batteries that came with the remote control unit facing in the directions shown in the figure, then close the rear cover.

Notes:

Using batteries improperly can cause them to explode. Take note of the following points:

- When replacing batteries, replace both batteries with new ones.
- Do not short-circuit, disassemble or heat batteries.
- Do not dispose of batteries into fire or flames.
- Dispose of spent batteries properly.

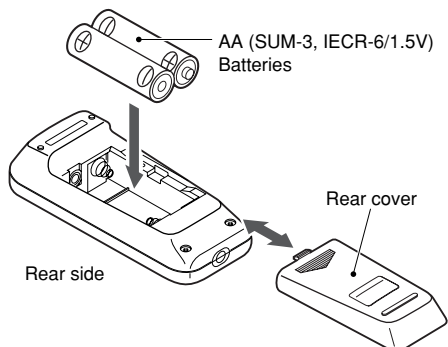

Functions of Remote Control Unit Buttons

Button \ Mode	Radio (RDS)	CD	MP3
[FUNC]	Switches between radio and CD/MP3.		
[BAND]	Switches reception band.	Plays the first track. Top play.	
[▲] , [▼]	Increases and decreases volume (in all modes).		
[◀] , [▶]	Moves preset channels up and down.	Moves tracks up and down. When pressed and held for 1 second: Fast-forward/ fast-backward.	
[▶/II]	Radio mute.	Switches between playback and pause.	
[MUTE]	Turns mute on and off.	Switches between playback and pause.	
[TA]	TA on and off.		
[DISP]	Switches among main display, clock display.		
[PS/AS] / [SCN]	Preset scan. When pressed and held for 2 seconds: Auto store.	Scan play.	Scan play. When pressed and held for 1 seconds: Folder scan.
[AF] / [RPT]	AF function on and off, when pressed and held for 1 second: REG function on and off.	Repeat play.	Repeat play. When pressed and held for 1 seconds: Folder repeat.
[PTY] / [RDM]	PTY stand by mode on and off.	Random play.	Random play. When pressed and held for 1 seconds: Folder random.

* Some of the corresponding buttons on the main unit and remote control unit have different functions.

* DUAL ZONE button is not available.

5. DCP

The control panel can be detached to prevent theft. When detaching the control panel, store it in the DCP (DETACHABLE CONTROL PANEL) case to prevent scratches.

We recommend taking the DCP with you when leaving the car.

Removing the DCP

1. Press the [FNC] button for 1 second or longer to switch off the power.
2. Press in the [RELEASE] button.

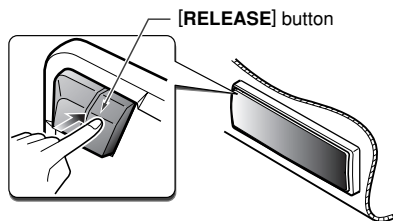

* The DCP is unlocked

3. Remove the DCP.

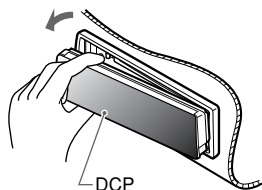

Attaching the DCP

1. Insert the right side of the DCP into the main unit.
2. Insert the left side of the DCP into the main unit.

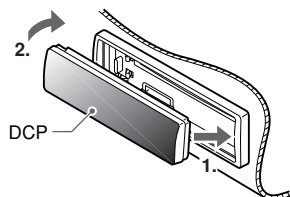

Storing the DCP in the DCP Case

Hold the DCP, in the orientation as shown in the figure below, and put it into the supplied DCP case. (Ensure the DCP is in the correct orientation.)

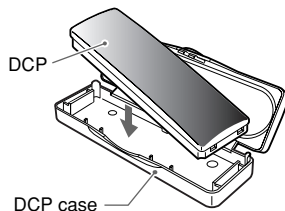

CAUTION

- The DCP can easily be damaged by shocks. After removing it, be careful not to drop it or subject it to strong shocks.
- When the Release button is pressed and the DCP is unlocked, the car's vibrations may cause it to fall. To prevent damage to the DCP, always store it in its case after detaching it. (See figure above.)
- The connector connecting the main unit and the DCP is an extremely important part. Be careful not to damage it by pressing on it with fingernails, screwdrivers, etc.

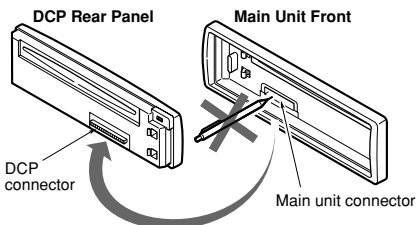

Note:

- If the DCP is dirty, wipe off the dirt with a soft, dry cloth only.

6. OPERATIONS

Basic Operations

Note: Be sure to read this chapter referring to the front diagrams of chapter "2. CONTROLS" on page 5 (unfold).

⚠ CAUTION

Be sure to lower the volume before switching off the unit power or the ignition key. The unit remembers its last volume setting. If you switch the power off with the volume up, when you switch the power back on, the sudden loud volume may hurt your hearing and damage the unit.

Turning on/off the power

Note:

• Be careful about using this unit for a long time without running the engine. If you drain the car's battery too far, you may not be able to start the engine and this can reduce the service life of the battery.

1. Press the [FNC] button.
2. The illumination and display on the unit light up. The unit automatically remembers its last operation mode and will automatically switch to display that mode.
3. Press and hold the [FNC] button for 1 second or longer to turn off the power for the unit.

Selecting a mode

1. Press the [FNC] button to change the operation mode.
2. Each time you press the [FNC] button, the operation mode changes in the following order:
Radio mode → CD mode → Radio mode...

Note:

• If the CD mode is selected when no disc is inserted, the display shows "NO DISC".

Adjusting the volume

Turning the [ROTARY] knob clockwise increases the volume; turning it counterclockwise decreases the volume.

* The volume level is from 0 (minimum) to 33 (maximum).

Audio Mode Adjustments

Press the [A-M] button to select the adjustment mode. The mode switches as follows each time the [A-M] button is pressed:

BASS → TREB → BAL → FAD → Previous mode

When the Z-Enhancer function is turned on, BASS (bass) and TRE (treble) cannot be selected.

Switching display

Press and hold the [BND] button, and then press the [DISP] button to select the desired display.

The display switches in the following order:

Main → Clock (CT) → Main ...

- * If the display is changed by other button operation when the clock (CT) is displayed, the clock display returns automatically after the operation.
- * The example shows the display in radio mode.

Main display



Clock(CT) display

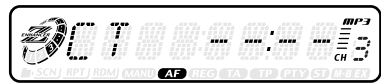

Main display

Setting the Z-Enhancer

This unit are provided with 3 types of sound tone effects stored in memory. Select the one you prefer.

* The factory default setting is "Z-EHCR OFF".

Each time you press the [Z-ENCR] button, the tone effect changes in the following order:

"Z-ENHANCER 1" → "Z-ENHANCER 2" → "Z-ENHANCER 3" → "Z-EHCR OFF" → "Z-ENHANCER 1"...

- Z-ENHANCER 1 : bass emphasized
- Z-ENHANCER 2 : treble emphasized
- Z-ENHANCER 3 : bass and treble emphasized
- Z-EHCR OFF : no sound effect

Basic Operations

Adjusting the bass

1. Press the [A-M] button and select "BASS".
2. Turning the [ROTARY] knob clockwise emphasizes the bass; turning it counterclockwise attenuates the bass.
 - * The factory default setting is "0". (Adjustment range: -7 to +7)
3. When the adjustment is complete, press the [A-M] button several times until the function mode is reached.

Adjusting the treble

1. Press the [A-M] button and select "TREB".
2. Turning the [ROTARY] knob clockwise emphasizes the treble; turning it counterclockwise attenuates the treble.
 - * The factory default setting is "0". (Adjustment range: -7 to +7)
3. When the adjustment is complete, press the [A-M] button several times until the function mode is reached.

Adjusting the balance

1. Press the [A-M] button and select "BAL".
2. Turning the [ROTARY] knob clockwise emphasizes the sound from the right speaker; turning it counterclockwise emphasizes the sound from the left speaker.
 - * The factory default setting is "0". (Adjustment range: L13 to R13)
3. When the adjustment is complete, press the [A-M] button several times until the function mode is reached.

Adjusting the fader

1. Press the [A-M] button and select "FAD".
2. Turning the [ROTARY] knob clockwise emphasizes the sound from the front speakers; turning it counterclockwise emphasizes the sound from the rear speakers.
 - * The factory default setting is "0". (Adjustment range: F12 to R12)
3. When the adjustment is complete, press the [A-M] button several times until the function mode is reached.

Note:

- * Bass and Treble can only be adjusted when the "Z-enhancer" is off.

Turning on/off MAGNA BASS EX

To adjust the MAGNA BASS EX

The MAGNA BASS EX does not adjust the low sound area like the normal sound adjustment function, but emphasizes the deep bass sound area to provide you with a dynamic sound.

- * The factory default setting is off. Press and hold the [A-M] button for 1 second or longer to turn the MAGNA BASS EX and "M-B EX" in the display lights on or off.

CT (Clock Time) function

The CT function enables you to display clock time only when CT data is received.

Press and hold the [BND] button, and then press the [DISP] button, the display switches to CT (Clock Time).

- * When no CT data is received, "CT—:—" appears in the display.

Note:

- * There are some countries and stations where clock time data are not transmitted. In some areas, the CT may not be displayed correctly.

Triggered audio mute for cellular telephones

This unit requires special wiring to mute the audio signal automatically when a cellular telephone rings in the car.

- * This function is not compatible with all cellular telephones. Contact your local authorized Clarion dealer for information on proper installation and compatibility.

- * The factory default setting is "TEL OFF".

Press and hold the [BND] button, and then press the [▶/II] to select the "TEL ON", "TEL L", "TEL R" or "TEL OFF".

TEL MUTE: mutes the audio sound.

TEL L: front left speaker output telephone audio.

TEL R: front right speaker output telephone audio.

TEL OFF: does not mute the audio sound.

▶ TEL MUTE → TEL L → TEL R → TEL OFF ▶

Illumination dimmer function

When the illumination line of this unit is connected with the car-side illumination signal line, the display illumination of this unit dims in connection with turning on the car-side illumination.

Turning the screen saver function on or off

This unit is provided with the screen saver function. You can turn on and off this function.

If the button operation is performed with the screen saver function on, the operation display corresponding to the button operation is shown for about 10 seconds and the display returns to the screen saver display.

* The factory default setting is on.

Press the [SS/SCRL] button while keeping the [BND] button pressed, to turn the screen saver function on or off.

Listening to the radio

1. Press the [FNC] button and select the radio mode. The frequency or PS appears in the display.
 - * PS: Programme service name
2. Press the [BND] button and select the radio band. Each time the button is pressed, the radio reception band changes in the following order:

FM1 → FM2 → FM3 → AM (MW/LW) → FM1...
3. Press the [◀] or [▶] button to tune in the desired station.

Tuning

There are 3 types of tuning mode available, seek tuning, manual tuning and preset tuning.

Seek tuning

There are 2 types of seek tuning: DX SEEK and LOCAL SEEK.

DX SEEK can automatically tune in to receivable broadcast stations; LOCAL SEEK can tune in to only broadcast stations with a good reception sensitivity.

1. Press the [BND] button and select the desired band (FM or AM (MW, LW)).
2. Tune into a station.
 - * If "MANU" is lit in the display, press and hold the [BND] button for 2 seconds or longer. "MANU" in the display goes off and seek tuning is now available.
 - * If "TA" is lit in the display, TP stations are automatically sought.

● DX SEEK

Press the [◀] or [▶] button to automatically seek a station.

When the [▶] button is pressed, the station is sought in the direction of higher frequencies; if the [◀] button is pressed, the station is sought in the direction of lower frequencies.

* When seek tuning starts, "DX" appears in the display.

● LOCAL SEEK

If you press and hold the [◀] or [▶] button for 1 second or longer, local seek tuning is carried out. Broadcast stations with good reception sensitivity are selected.

* When local seeking starts, "LO" appears in the display.

Radio Operations

Manual tuning

There are 2 ways available: Quick tuning and step tuning.

When you are in the step tuning mode, the frequency changes one step at a time. In the quick tuning mode, you can quickly tune the desired frequency.

1. Press the **[BND]** button and select the desired band (FM or AM (MW/LW)).
 - * If "MANU" is not lit in the display, press and hold the **[BND]** button for 2 seconds or longer. "MANU" is lit in the display and manual tuning is now available.
2. Tune into a station.

● Quick tuning:

Press and hold the **[◀◀]** or **[▶▶]** button for 1 second or longer to tune in a station.

● Step tuning:

Press the **[◀◀]** or **[▶▶]** button to manually tune in a station.

Recalling a preset station

A total of 24 preset positions (6-FM1, 6-FM2, 6-FM3, 6-AM) exists to store individual radio stations in memory. Pressing the corresponding **[DIRECT]** button recalls the stored radio frequency automatically.

1. Press the **[BND]** button and select the desired band (FM or AM (MW/LW)).
2. Press the corresponding **[DIRECT]** button to recall the stored station.
 - * Press and hold one of the **[DIRECT]** buttons for 2 seconds or longer to store that station into preset memory.

Manual memory

1. Select the desired station with seek tuning, manual tuning or preset tuning.
2. Press and hold one of the **[DIRECT]** buttons for 2 seconds or longer to store the current station into preset memory.

Auto store

Auto store is a function for storing up to 6 stations that are automatically tuned in sequentially. If 6 receivable stations cannot be received, a previously stored station remains unoverwritten at the memory position.

Notes:

- The only FM band that can store the stations will automatically be stored in FM3.
 - When the auto store is performed, the station previously stored in the memory at that position is overwritten.
 - If there are fewer than 6 stations with good reception, the stations previously stored at the remaining **[DIRECT]** buttons are not overwritten.
 - A station already stored in one of **[DIRECT]** buttons cannot be stored in another **[DIRECT]** buttons.
1. Press the **[BND]** button and select the desired band (FM or AM (MW/LW)).
 2. Press and hold the **[PS/AS]** button for 2 seconds or longer. The stations with good reception are stored automatically to the preset channels.
 - * If auto store is performed in the FM bands, the stations are stored in FM3 even if FM1 or FM2 was chosen for storing stations.

Preset scan

Preset scan receives the stations stored in preset memory in order. This function is useful when searching for a desired station in memory.

1. Press the **[PS/AS]** button.
2. When a desired station is tuned in, press the **[PS/AS]** button again to continue receiving that station.

Note:

- Be careful not to press and hold the **[PS/AS]** button for 2 seconds or longer, otherwise the auto store function is engaged and the unit starts storing stations.

RDS Operations

RDS (Radio Data System)

This unit has a built-in RDS decoder system that supports broadcast stations transmitting RDS data.

This system can display the name of the broadcast station being received (PS) and can automatically switch to the broadcast station with the best reception as you move long distances (AF switching).

Also, if a traffic announcement or programme type is broadcast from an RDS station, no matter what mode you are in, this broadcast is received.

Additionally, if EON information is received, this information enables automatic switching of other preset stations on the same network and interruption of the station being received with traffic information from other stations (TP). This function is not available in some areas.

When using the RDS function, always set the radio to FM mode.

- AF : Alternative Frequency
 - PS : Programme Service Name
 - PTY : Programme Type
 - EON : Enhanced Other Network
 - TP : Traffic Programme
- * RDS interrupt does not function during AM radio reception.

AF function

The AF function switches to a different frequency on the same network in order to maintain optimum reception.

* The factory default setting is "ON".

● Switching OFF the AF function

Press the [AF] button. "AF" in the display goes off and the AF function turns off.

● Switching ON the AF function

Press the [AF] button. "AF" in the display lights and the AF function turns on.

* If the reception of the current broadcast station deteriorates, "SEARCH" appears in the display and the radio searches for the same programme on another frequency.

REG (Regional programme) function

When the REG function is ON, the optimum regional station can be received. When this function is OFF, if the regional station area switches as you drive, a regional station for that region is received.

* The factory default setting is "OFF".

Notes:

- This function is disabled when a national station such as BBC R2 is being received.
- The REG function ON/OFF setting is valid when the AF function is ON.

● Switching the REG function ON

Press and hold the [AF] button for 1 second or longer.

"REG" in the display lights and the REG function turns on.

● Switching the REG function OFF

Press and hold the [AF] button for 1 second or longer.

"REG" in the display goes off and the REG function turns off.

Manually tuning a regional station in the same network

1. This function is valid when the AF function is ON and the REG function is OFF.

Note:

- This function can be used when a regional broadcast of the same network is received.
2. Press any one of the [DIRECT] buttons to call out the regional station.
 3. If the reception condition of the called out station is bad, press the [DIRECT] button of the same number. The unit receives a local station on the same network.

TA (Traffic Announcement)

In the TA standby mode, when a traffic announcement broadcast starts, the traffic announcement broadcast is received as top priority regardless of the function mode so you can listen to it. Traffic programme (TP) automatic tuning is also possible.

* This function can only be used when "TP" is lit in the display. When "TP" is lit, this means that the RDS broadcast station being received has traffic announcement programmes.

● Setting the TA standby mode

If you press the [TA] button when only "TP" is lit in the display, "TP" and "TA" light in the display and the unit is set into the TA standby mode until a traffic announcement is broadcast. When a traffic announcement broadcast starts, "TRA INFO" appears in the display. If you press the [TA] button while a traffic announcement broadcast is being received, the traffic announcement broadcast reception is cancelled and the unit goes into the TA standby mode.

RDS Operations

● Cancelling the TA standby mode

With "TP" and "TA" lit in the display, press the [TA] button. The "TA" in the display goes off and the TA standby mode is cancelled.

* If "TP" is not lit, pressing the [TA] button searches for a TP station.

● Searching for a TP station

When "TP" is not lit, if you press the [TA] button, "TA" in the display lights and the unit automatically receives a TP station.

Note:

• If a TP station is not received, the unit continues the search operation. Pressing [TA] button again goes off "TA" in the display and stops TP station searching.

Auto store function for TP stations

You can automatically store up to 6 TP stations into preset memory. If the number of TP that can be received is less than 6, broadcast stations already stored in memory are left without being overwritten.

With "TA" lit in the display, press and hold the [PS/AS] button for 2 seconds or longer. The TP stations with the good reception sensitivity are stored into preset memory.

* Even if you select FM1 or FM2, a TP station is stored into memory for FM3.

PTY

This function enables you to listen to a broadcast of the selected programme type when it starts even if the unit is on a function mode other than radio.

* Some countries do not yet have PTY broadcast.
* In the TA standby mode, a TP station has priority over a PTY broadcast station.

● Setting the PTY standby mode

When you press the [PTY] button, "PTY" lights in the display and the PTY standby mode is turned on. When the selected PTY broadcast starts, the PTY item name appears in the display.

● Cancelling the PTY standby mode

When you press and hold the [PTY] button for 1 second or longer, "PTY" goes off in the display and PTY standby mode is cancelled.

● Cancelling a PTY interrupt broadcast

Press the [PTY] button during the PTY interrupt broadcast, the PTY interrupt is cancelled and the unit returns to PTY standby mode.

Selecting PTY

1. When you press the [PTY] button, the unit goes into PTY select mode.
2. Press any one of the [DIRECT] buttons. Alternatively, turn the [ROTARY] knob clockwise or counterclockwise to select the desired PTY.
* Below are the factory default settings stored for the [DIRECT] buttons.

Preset number	PTY item	
	ENGLISH	Contents
1	NEWS	News
2	INFO	Information
3	POP M	Pop Music
4	SPORT	Sport
5	CLASSICS	Serious Classical Music
6	EASY M	Easy Listening Music

3. The PTY select mode is cancelled automatically 7 seconds after a PTY is selected.

PTY seek

1. When you press the [PTY] button, the PTY select mode is turned on.
2. Select PTY.
3. Press the [◀] or [▶] button. If you press the [▶] button, the unit seeks a PTY broadcast moving up the frequencies; if you press the [◀] button, it seeks moving down the frequencies.
* If no station with the selected PTY broadcast can be received, the unit returns to the PTY select mode.

PTY preset memory

- When you press the [PTY] button, the PTY select mode is turned on.
- Turn the [ROTARY] knob clockwise or counterclockwise to select the desired PTY.
The 29 types of PTY below can be selected.

PTY item	
ENGLISH	Contents
NEWS	News
AFFAIRS	Today's events
INFO	Information
SPORT	Sports
EDUCATE	Education
DRAMA	Drama
CULTURE	Culture
SCIENCE	Science
VARIED	Variety
POP M	Pop music
ROCK M	Rock music
EASY M	Easy music
LIGHT M	Light music
CLASSICS	Classics
OTHER M	Other music
WEATHER	Weather
FINANCE	Finance
CHILDREN	For children
SOCIAL	Social
RELIGION	Religion
PHONE IN	Phone in
TRAVEL	Travel
LEISURE	Leisure
JAZZ	Jazz
COUNTRY	Country
NATION M	Nation music
OLDIES	Oldies
FOLK M	Folk music
DOCUMENT	Documentaries

- If you press and hold any one of the [DIRECT] buttons for 2 seconds or longer, the selected PTY is stored into that preset channel memory.

Emergency broadcast

If an emergency broadcast is received, all the function mode operations are stopped. "ALARM" appears in the display and the emergency broadcast can be heard.

●Cancelling an emergency broadcast

If you press the [AF] button, emergency broadcast reception is cancelled.

Volume setting of TA, emergency broadcast (ALARM) and PTY

The volume for TA, ALARM and PTY interrupts can be set during TA, ALARM or PTY interrupt.

* The factory default setting is "15".

During a TA, ALARM or PTY interrupt, turn the [ROTARY] knob clockwise or counterclockwise to set the volume to the desired level (0 to 33).

* When the TA, ALARM or PTY interrupt ends, the volume returns to the level it had before the interrupt.

CD/MP3 Mode Operations

Loading a CD

Insert a CD into the center of the CD insertion slot with the labeled side facing up. "LOAD" appears in the display, the CD enters into the slot and start playing.

Notes:

- Do not put your hand, fingers, or foreign objects into the CD insertion slot.
- If a CD has already been loaded, another CD cannot be inserted. Do not insert another one forcefully.
- Discs not bearing the  mark cannot be played with the unit. CD-ROMs cannot be played.
- Some CDs recorded in CD-R/CD-RW mode may not be usable.

Caution:

- Single CD (3"(8 cm)), cannot be played with the unit.

Listening to the Disc already Inserted

Press the [FNC] button to select the CD mode, the CD will start playing.

Stopping (pausing) Playback

While the CD playing pressing the [▶/||] button will stop the CD and "PAUSE" indicate.

Press the [▶/||] button again to resume playback.

Ejecting the CD

Press the [▲] button, then the CD will be ejected.

Note:

- If the ejected CD is left as it is, it will be reloaded after 15 seconds.

Top Function

Press the [BND] button, then the CD will start playing from the first song (track number 1).

Selecting Tracks (songs)

Press the [◀|▶] button.

- ▶▶: Playback will start from the next track.
- ◀◀: Playback will start from the beginning of the track currently playing. When this button is pressed again, the CD will play from the previous track.

Fast-Forward and Fast-Backward

Press and hold the [◀|▶] button.

- ▶▶▶▶: To fast-forward
- ◀◀◀◀: To fast-backward

- * Pressing the [◀|▶] button for 1 second or longer will move forward or backward 3 times faster than normal play, and pressing it for 3 seconds or longer will do the operation 30 times faster.

Scan Play (Intro Music Scan)

At Audio CD press the [SCN] button, then the display shows "SCN", then the CD will play the first 10 seconds of each track of the whole disc. Press the [SCN] button again to disengage the unit from scan play.

- * A scan play will start from the track following the one currently playing.

Repeat Play

At Audio CD press the [RPT] button, then the display shows "RPT", then the track currently playing will be played repeatedly. Press the [RPT] button again to disengage the unit from repeat play.

Random Play

At Audio CD press the [RDM] button, then the display will show "RDM", then the entire tracks on the disc will be played at random. Press the [RDM] button again to disengage the unit from random play.

MP3 Special Function Menu

1. When playing an MP3 CD, press the [ROTARY] knob to display the MP3 Special Function Menu.
2. There are 3 functions in the Special Function Menu.

FLD UP: DN → MP3 SEL → MP3 SRCH

3. To go to the next function, press the [ROTARY] knob again.
4. When a function is selected, turn the [ROTARY] knob clockwise or counterclockwise to activate it. At this Special Function Menu, all the channel keys CH1 to CH6 are inoperable.

Note:

- The Special Function Menu can be released by pressing the [ROTARY] knob for 2 seconds or longer, or it will be released automatically after 7 seconds.

FLD UP: DN – Folder Up Down Function

1. This function enables you to search for a folder on the MP3 CD. The LCD will show the target MP3 CD folder.

Turn clockwise. – Folder up

Turn counterclockwise. – Folder down

2. When a desired folder is selected, the MP3 CD player will play it.

Note:

- The Special Function Menu can be released by pressing the [ROTARY] knob for 2 seconds or longer, or it will be released automatically after 7 seconds.

MP3 SEL – File search Function

1. This function enables you to select a file from the whole CD by reading the folder name and file name without stopping CD during MP3 CD play.
2. To activate this function, turn the [ROTARY] knob clockwise or counterclockwise until the LCD displays M-SEL ON.
3. When the function is activated, the LCD displays the MP3 CD folder then MP3 track currently being played.

The file name will be displayed for 1.3 seconds and then start scrolling. The MP3 SEL function will be released automatically unless the next command is executed in 15 seconds.

Turn clockwise. – Track up

Turn counterclockwise. – Track down or back.

4. To exit from the current folder, turn the [ROTARY] knob counterclockwise and press the [ROTARY] knob when there is << BACK display on the LCD screen.

	Display	Pressing [ROTARY] knob	Description
1	F>	Open Folder	Indicates this is a folder
2	File Name	Play current file	Indicates this is a file name
3	<<BACK	Exit current Folder	Indicates this is the top of the folder

Display chart at MP3 SEL mode

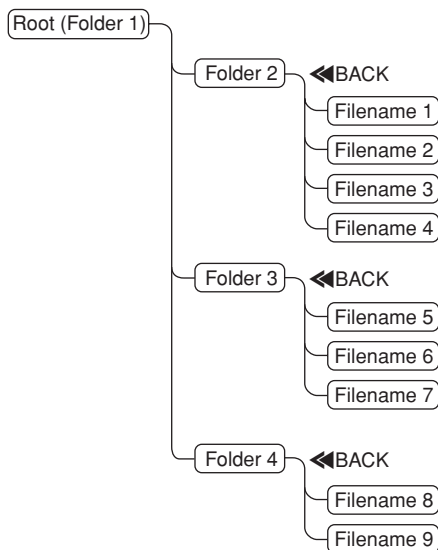

Example:

1. If you are at File name 2 and want to go to File name 6, exit Folder 2 and enter Folder 3 to search for File name 6.
2. The Special Function Menu can be released by pressing the [ROTARY] knob for 2 seconds or longer, or it will be released automatically after 7 seconds.

MP3 Special Function Menu

MP3 SRCH – Search File Function

1. This function enables you to search a desired folder and track by selecting the characters on the MP3 CD.
2. When this function is on, the LCD will display “SCH>” and the start character blinking is “ ” which is a blank character. The character changes start from 0 to 9 for number display and A to Z for capital letter display, and starts from “ ” again if you turn the [ROTARY] knob clockwise. The character changes from Z to A and 9 to 0 and starts from “ ” again if you turn the [ROTARY] knob counterclockwise.
3. To search for a file, you have to select 4 characters. After selecting the first character, press the [ROTARY] knob to go to the second character.
4. When the last character of the file name is selected by pressing, the MP3 CD player will start searching for the file. If you enter “”, the player will be unable to find the file and show “NOTFOUND” on the LCD.
5. If the file or folder is found, the MP3 CD player will display the found folder with the “F>” sign or the filename without any sign.
6. If the file is not found, “NOTFOUND” will be displayed. If you enter a folder name, the MP3 CD player will function in the MP3 SEL mode to allow you to select an MP3 file from the whole MP3 CD.
7. The Special Function Menu will be released by pressing the [ROTARY] knob for 2 seconds or longer, or it will be released automatically after 15 seconds.

	Display	Pressing [ROTARY] knob	Description
1	F>	Open Folder	Indicates this is a folder
2	File Name	Play current file	Indicates this is a file name
3	◀BACK	Exit current Folder	Indicates this is the top of the folder

RANDOM MP3 CD

1. This function enables you to play all the tracks in the MP3 folder or on the disc in random order.
2. There are 2 types of random play accessible for MP3 CDs; Random track and Random folder.

RDM access	Function	Display
Press [RDM] button (CH3) less than 1 seconds	Random in current folder	RDM indicator
Press [RDM] button (CH3) more than 1 seconds	Random all folder	Folder & RDM indicator

3. Each time the button is pressed, random play turns on or off.
4. When the random play function is on, the RDM indicator will be displayed. When the function is off, the indicator will not be displayed.

REPEAT MP3 CD

1. This function enables you to replay the track or folder you are listening to.
2. There are 2 types of repeat play accessible for MP3 CD; Repeat track and Repeat folder.

RPT access	Function	Display
Press [RPT] button (CH2) less than 1 seconds	Repeat current song	RPT indicator
Press [RPT] button (CH2) more than 1 seconds	Repeat current folder	Folder & RPT indicator

3. Each time the button is pressed, repeat play turns on or off.
4. When the repeat play function is on, the RPT indicator will be displayed. When the function is off, the indicator will not be displayed.

SCAN MP3 CD

1. This function enables you to play the first 10 seconds of each track in the MP3 mode.
2. When this function is on, the indicator will be displayed. When this function is off, the indicator will not be displayed.
3. There are 2 types of scan play accessible for MP3 CD; Scan track and Scan folder.

SCN access	Function	Display
Press [SCN] button (CH1) less than 1 second	Scan in current folder	SCN indicator
Press [SCN] button (CH1) more than 1 second	Scan all folder	Folder & SCN indicator

- Each time the button is pressed, scan play turns on or off.
- When the scan play function is on, the SCN indicator will be displayed. When the function is off, the indicator will not be displayed.

DISPLAY SELECTION

- You can choose the display type for MP3 CD by pressing the [DISP] (CH4) button.

To go to the next type, press the [DISP] (CH4) button again.

The arrangement is shown below.

****Please refer to figure 1**

TITLE DISPLAY MODE

- There are 5 types of display for the Title Display mode.
- To go to the next type, press the [DISP] (CH4) button for 1 second or longer.
The arrangement is shown below.

After 2 seconds

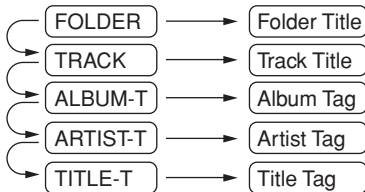

- The displayed item can be scrolled by pressing the CH6 button if the number of characters is more than 8.
- After the main display is shown for 4 seconds and if the CD mechanism is still decoding the data, READING is shown on the LCD.

MP3 Special Function Menu

Figure 1

Display selection

You can choose the display type for MP3 CD by pressing the [DISP] (CH4) button. To go to the next type, press the [DISP] (CH4) button again. The arrangement is shown below:

DISPLAY SELECT OPERATION

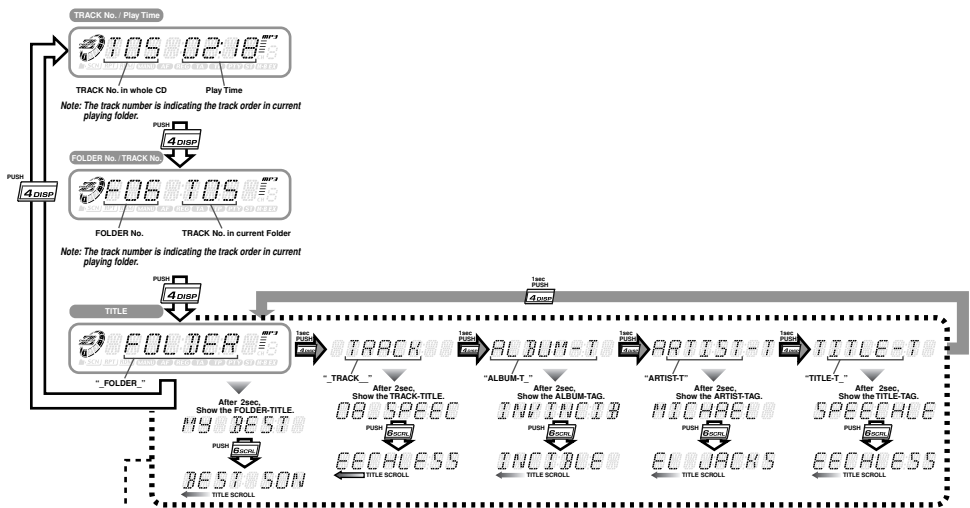

• The displayed item can be scrolled by pressing the CH6 button if the number of character is more than 8.

7. IN CASE OF DIFFICULTY

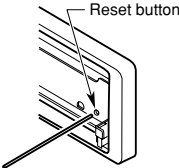
Problem	Cause	Solution
Power does not turn on. (No sound is produced.)	Fuse is blown.	Replace with a fuse of the same amperage. If the fuse blows again, consult your store of purchase.
	Incorrect wiring.	Consult your store of purchase.
Compact disc cannot be loaded.	Another compact disc is already loaded.	Eject the compact disc before loading the new one.
Sound skips or is noisy.	Compact disc is dirty.	Clean the compact disc with a soft cloth.
	Compact disc is heavily scratched or warped.	Replace with a compact disc with no scratches.
Sound is bad directly after power is turned on.	Water droplets may form on the internal lens when the car is parked in a humid place.	Let dry for about 1 hour with the power on.
Nothing happens when button are pressed. Display is not accurate.	The microprocessor has malfunctioned due to noise, etc.	Turn off the power, then press the [RELEASE] button and remove the DCP. Press the reset button for about 2 seconds with a thin rod. 
	DCP or main unit connectors are dirty.	Wipe the dirt off with a soft cloth moistened with cleaning alcohol.

8. ERROR DISPLAYS

- To protect the system, this unit has been equipped with self diagnostic functions. If a fault arises, a warning is issued by various error displays. Follow the corrective measures and remove the fault.

Error Display	Corrective Measure
ERROR 2	This error display indicates that a fault has arisen in the mechanism of the source unit (for example, the disc cannot be ejected). → Check the source unit.
ERROR 3	This error display indicates that the pickup focus is off because of a scratched disc or some other factor during source unit play. → Check the compact disc.
	This indicates that the CD's TOC (table of contents) cannot be read, for example because the selected disc is upside-down.

9. SPECIFICATIONS

FM Tuner

Frequency Range: 87.5 MHz to 108 MHz
 Usable Sensitivity: 11 dBf
 50 dB Quieting Sensitivity: 17 dBf
 Alternate Channel Selectivity: 75 dB
 Stereo Separation (1 kHz): 35 dB
 Frequency Response (± 3 dB): 30 Hz to 15 kHz

AM Tuner

Frequency Range:
 MW 531 kHz to 1602 kHz
 LW 153 kHz to 279 kHz
 Usable Sensitivity: 25 μ V

CD Player

System: Compact disc audio system
 Usable Discs: Compact disc
 Frequency Response: 10 Hz to 20 kHz (± 1 dB)
 Signal-to-Noise Ratio: 100 dB (1 kHz) IHF-A
 Dynamic Range: 95 dB (1 kHz)
 Harmonic Distortion: 0.01%

Audio

Maximum Power Output: 200 W (50 W \times 4 ch)
 Continuous Average Power Output:
 17 W \times 4, into 4 Ω , 20 Hz to 20 kHz, 1% THD
 Bass Control Action (30 Hz): ± 13 dB
 Treble Control Action (10 kHz): ± 12 dB
 Line Output (with A/C 1 kHz, 10 k Ω): 1.7 V

General

Power Supply Voltage:
 14.4 V DC (10.8 V to 15.6 V allowable),
 negative ground
 Current Consumption: Less than 15 A
 Speaker Impedance: 4 Ω (4 Ω to 8 Ω allowable)
 Weight: 2.42 lb. (1.1 kg)
 Dimensions:
 178 mm Width \times 50 mm Height \times 152 mm
 Depth

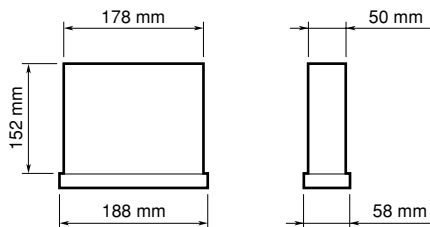

Notes:

- Specifications comply with EIA Standards.
- Specifications and design are subject to change without notice for further improvement.
- Please make sure when connecting external power amplifier, that you properly, to the car chassis, ground the amplifier.
- If this is not done, severe damage to the source unit may happen.