

Model  
H5341



**imaginext** SYSTEM

Fisher-Price

[www.fisher-price.com](http://www.fisher-price.com)

# Welcome to the Imaginext™ System

## **Younger children & those new to the Imaginext™ System**

Use our step-by-step instructions to build the structure shown on the cover of this booklet. Encourage your child to assist you with some of the simple steps. This assembly is ideal for active play and it can be used as a playset rather than a building toy.



## **Older children and experienced Imaginext™ System users**

The more your child plays with this toy, and development and skill increases, the less assistance your child needs! Experienced Imaginext™ users will enjoy using all parts of this toy to build their own structures or try building an alternate assembly shown below.



The colors and decorations of the product may sometimes vary from these instructions.

# One-Time Assembly

## ⚠ CAUTION

This toy contains small parts in its unassembled state.  
Adult assembly is required.

- Fit the pegs in the upper skull into the matching holes in the frame.
- Insert four screws into the back of the frame and tighten them to secure the upper skull. Do not over-tighten.
- Repeat this procedure to attach the lower skull.



#4 x  $\frac{3}{8}$ " Screw - 8  
Shown Actual Size

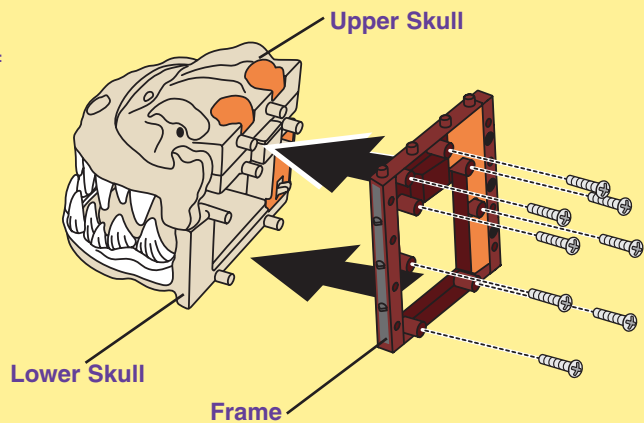

# Battery Installation

- Locate the battery compartment on the upper skull.
- Loosen the screw in the battery compartment door with a Phillips screwdriver. Remove the battery compartment door.
- Insert three, "AAA" (LR03) **alkaline** batteries, as indicated inside the battery compartment.

**Hint:** We recommend using **alkaline** batteries for longer battery life.

- Replace the battery compartment door and tighten the screw with a Phillips screwdriver. Do not over-tighten.
- When sounds or lights from this toy become faint or stop, it's time for an adult to change the batteries!

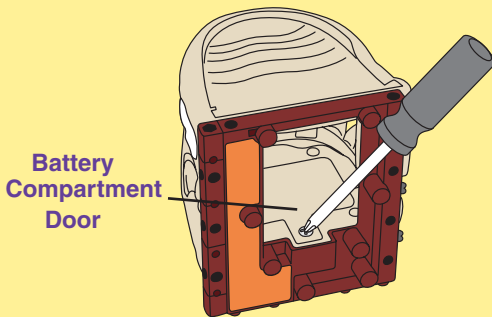

**BOTTOM VIEW**

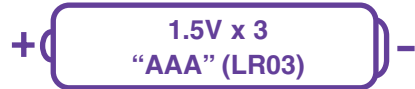

Shown Actual Size

## Battery Safety Information

Batteries may leak fluids that can cause a chemical burn injury or ruin your toy.

To avoid battery leakage:

- Do not mix old and new batteries or batteries of different types: alkaline, standard (carbon-zinc) or rechargeable (nickel-cadmium).
- Insert batteries as indicated inside the battery compartment.
- Remove batteries during long periods of non-use. Always remove exhausted batteries from the toy. Dispose of batteries safely. Do not dispose of batteries in a fire. The batteries may explode or leak.
- Never short circuit the battery terminals.
- Use only batteries of the same or equivalent type, as recommended.
- Do not charge non-rechargeable batteries.
- Remove rechargeable batteries from the toy before charging.
- If removable, rechargeable batteries are used, they are only to be charged under adult supervision.

# Let's Build It!

1.

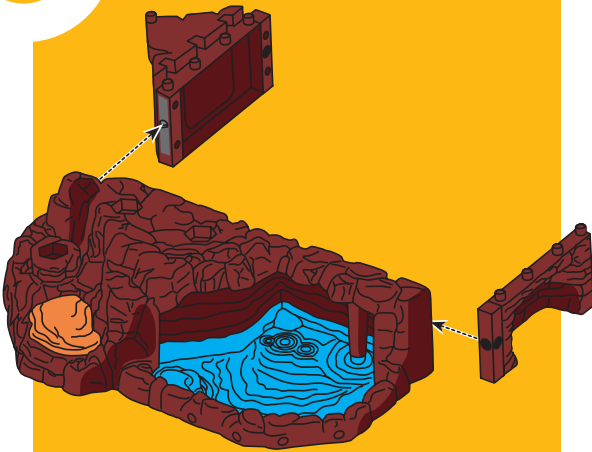

2.

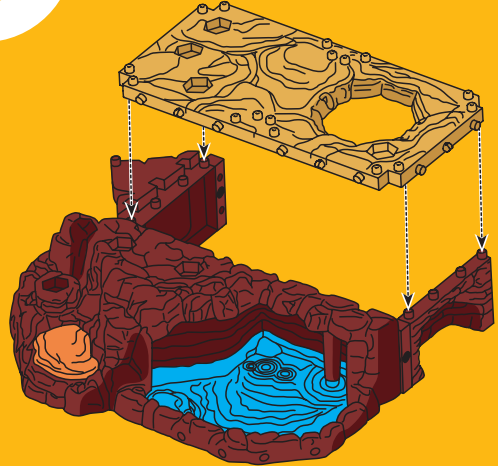

3.

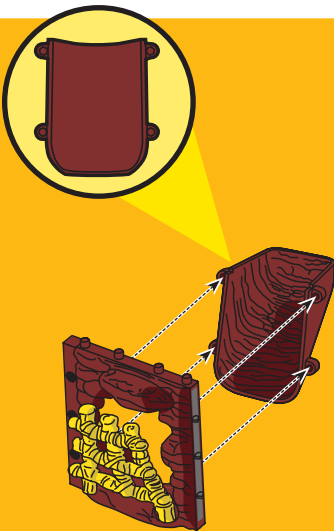

4.

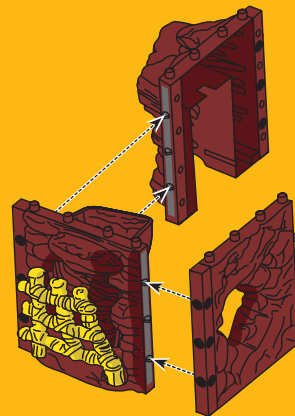

# Let's Build It!

5.

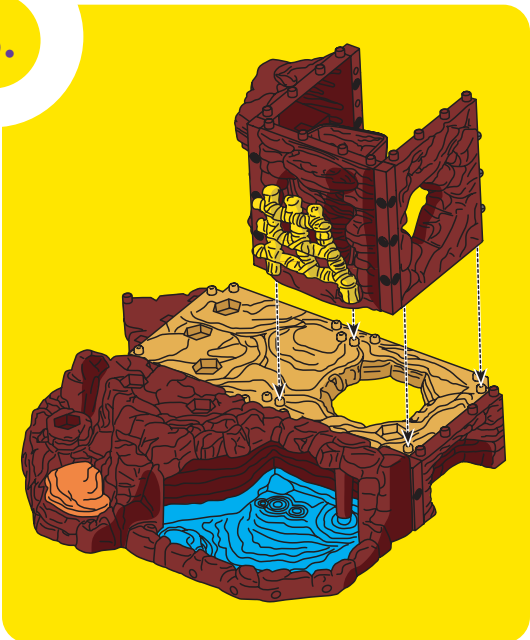

6.

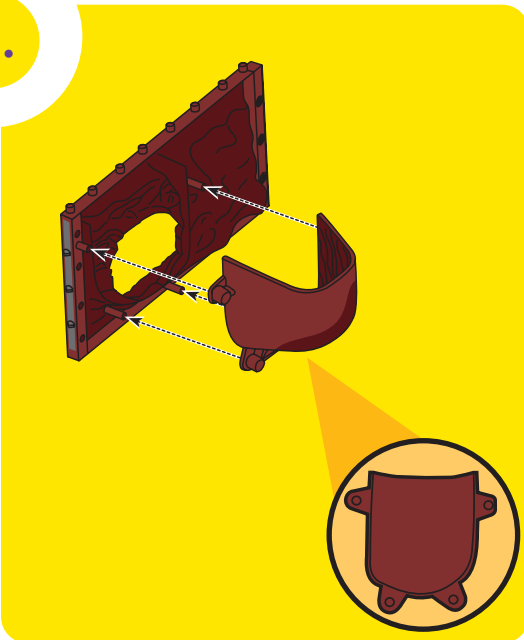

7.

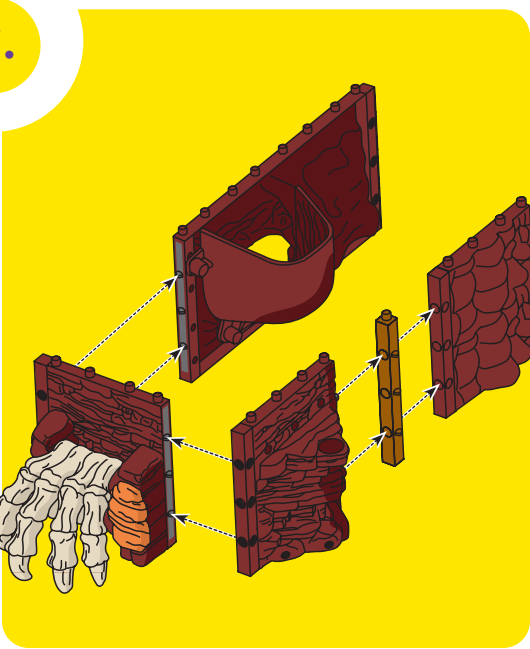

8.

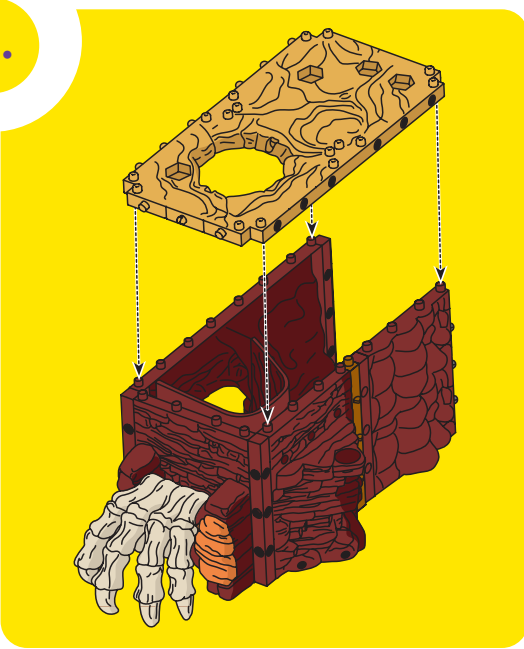

# Let's Build It!

9.

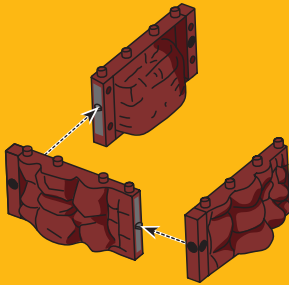

10.

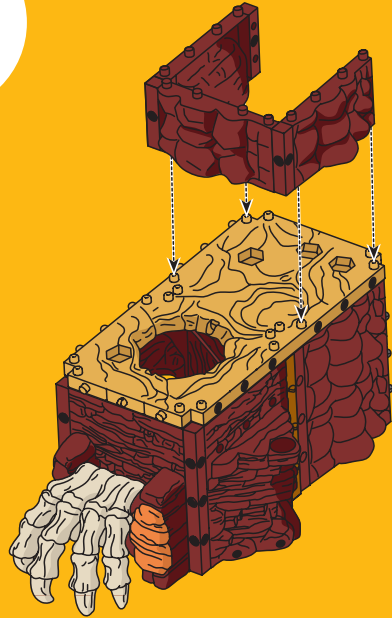

11.

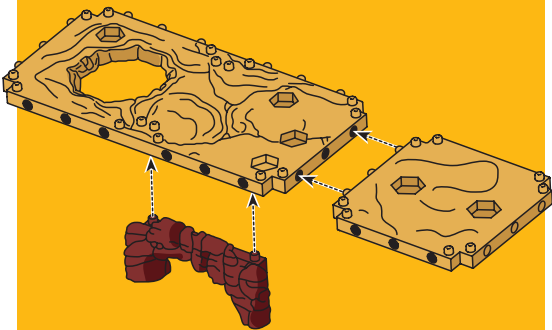

12.

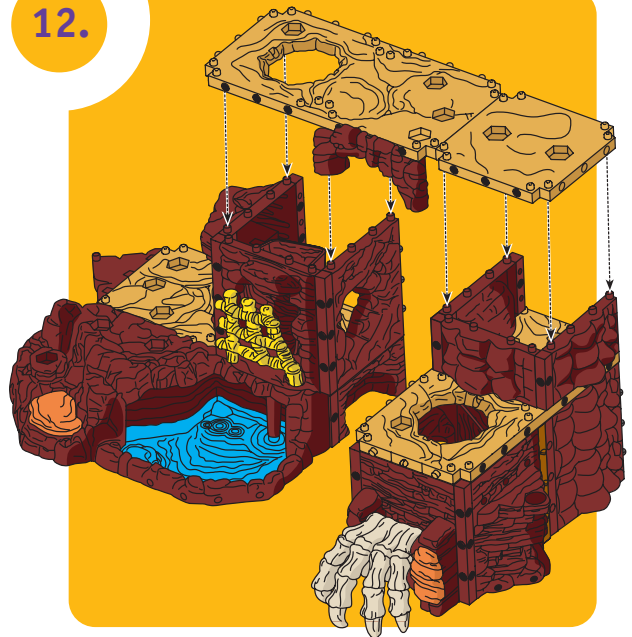

# Let's Build It!

13.

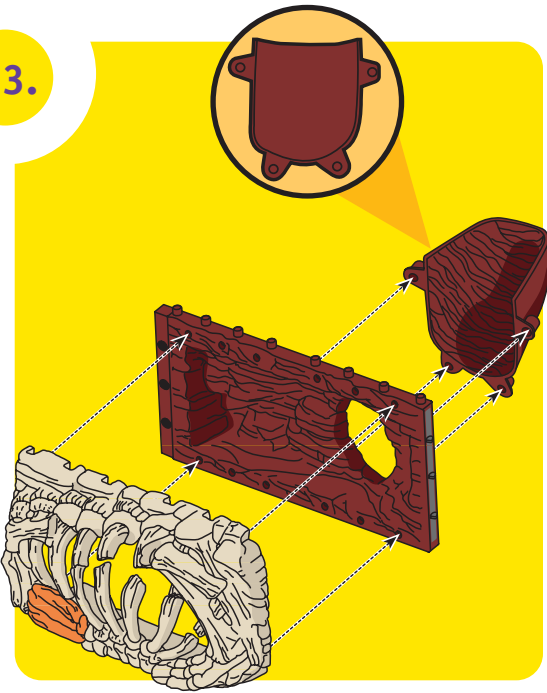

14.

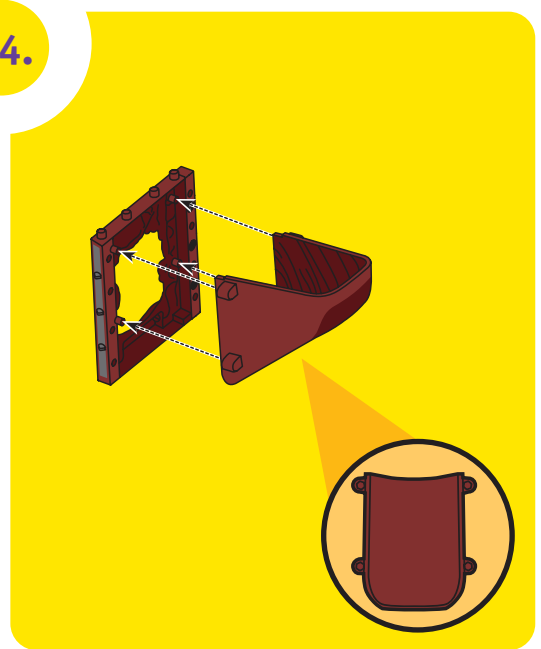

15.

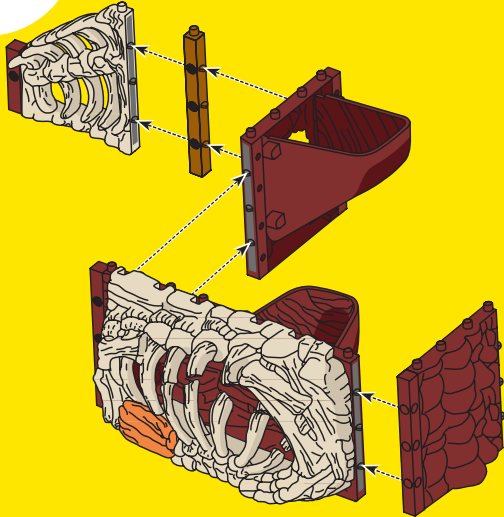

16.

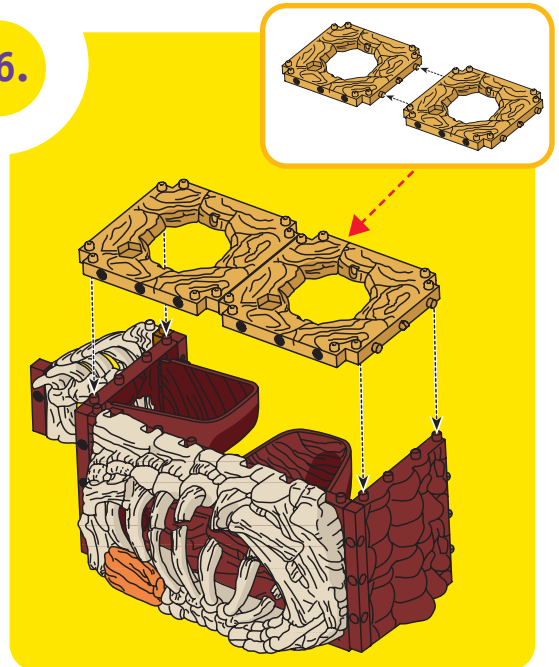



# Let's Build It!

17.

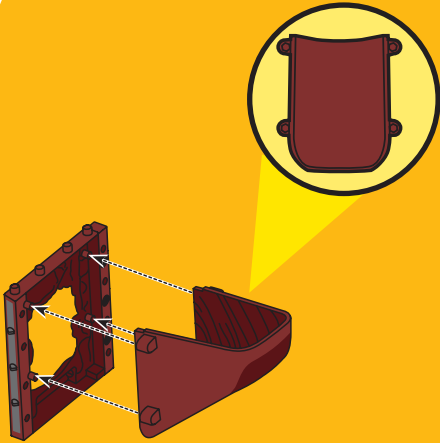

18.

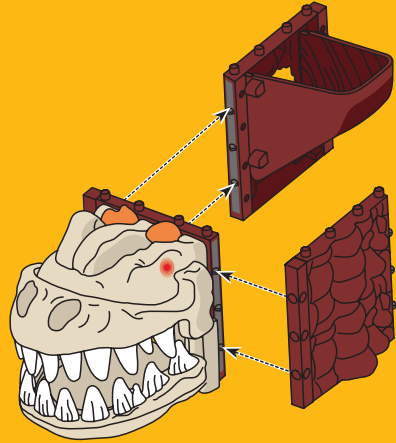

19.

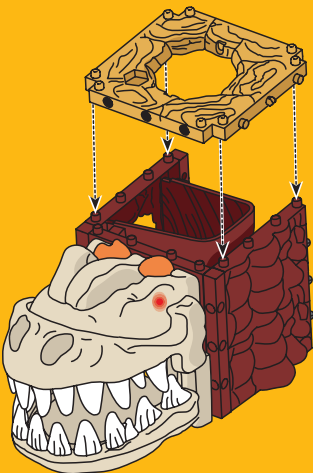

20.

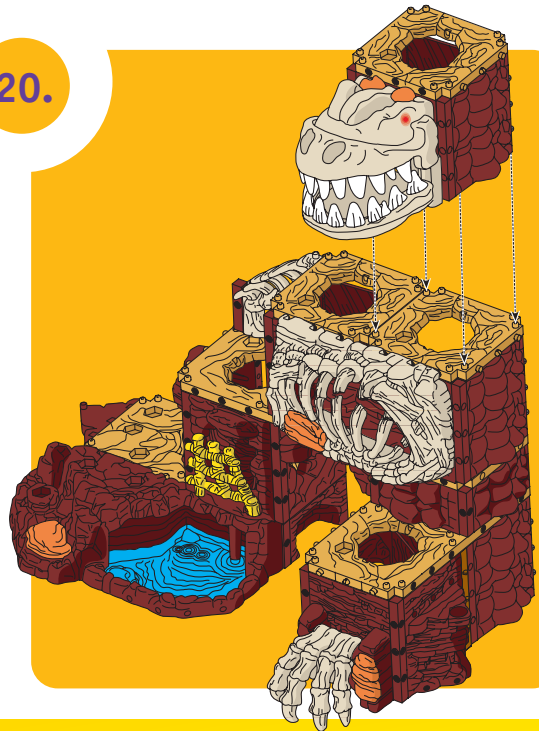



## The Predators vs. the Ecovores!



- Press claw print target to activate the claw trap.



- Press one button on top of the skull to make the eyes light up and “swallow” intruders.
- Press the other button for chomping sound effects and glowing eyes.



- Press the button to topple the prehistoric plant.

**IMPORTANT:** Only use projectiles supplied with this toy. Do not launch at people or animals or at point blank range.



- Place boulders into the chutes and watch them tumble out at the bottom.

### Care

- Wipe this toy with a clean cloth dampened with a mild soap and water solution. Do not immerse this toy.
- This toy has no consumer serviceable parts. Do not take this toy apart.

**Fisher-Price®**

**imaginext** SYSTEM™

**⚠ WARNING**

Warning – Choking Hazard. Not recommended for children under 3 years because it contains small parts that can be swallowed.

**Please keep this instruction sheet for future reference, as it contains important information.**

**Requires three “AAA” (LR03) alkaline batteries (not included).**

**For children 4-10 years. Adult assembly is required.**

**Tool required for assembly: Phillips screwdriver (not included).**

**FCC Note (United States Only)**

Note: This equipment has been tested and found to comply with the limits for a Class B digital device, pursuant to Part 15 of the FCC Rules. These limits are designed to provide reasonable protection against harmful interference in a residential installation. This equipment generates, uses and can radiate radio frequency energy and, if not installed and used in accordance with the instructions, may cause harmful interference to radio communications. However, there is no guarantee that interference will not occur in a particular installation. If this equipment does cause harmful interference to radio or television reception, which can be determined by turning the equipment off and on, the user is encouraged to try to correct the interference by one or more of the following measures:

- Reorient or relocate the receiving antenna.
- Increase the separation between the equipment and receiver.
- Consult the dealer or an experienced radio/TV technician for help.

Note: Changes or modifications not expressly approved by the manufacturer responsible for compliance could void the user's authority to operate the equipment.

**Questions? We'd like to hear from you!**

Call Fisher-Price® Consumer Relations, toll-free at **1-800-432-5437**, 8 AM - 6 PM EST

Monday through Friday. Hearing-impaired consumers using TTY/TDD equipment,

please call 1-800-382-7470. Or, Visit us on-line at [www.service.mattel.com](http://www.service.mattel.com).

Write to us at:

Fisher-Price® Consumer Relations, 636 Girard Avenue, East Aurora, New York 14052, U.S.A.

**For other countries outside the United States:**

**CANADA:** Questions? 1-800-432-5437. Mattel Canada Inc., 6155 Freemont Blvd., Mississauga, Ontario L5R 3W2; [www.service.mattel.com](http://www.service.mattel.com).

**GREAT BRITAIN:** Mattel UK Ltd., Vanwall Business Park, Maidenhead SL6 4UB. Helpline: 01628 500302.

**AUSTRALIA:** Mattel Australia Pty. Ltd., 658 Church Street, Locked Bag #870, Richmond, Victoria 3121 Australia.

Consumer Advisory Service 1300 135 312. **NEW ZEALAND:** 16-18 William Pickering Drive, Albany 1331, Auckland.

**ASIA:** Mattel East Asia Ltd, Room 1106, South Tower, World Finance Centre, Harbour City, Tsimshatsui, HK, China.