



OWNER'S MANUAL

# CD 303 T SACD Professional Version

Super Audio CD Player

NOTE: Before installing your new component, please read this manual carefully as it will inform you of the product specifications, proper installation and correct operating procedures for your unit. Also included in this manual are guidelines on how to service and care for your new Cary Audio Design product.

# TABLE OF CONTENTS

---

<b>Important Safety Instructions</b> .....	2
<b>Welcome</b>	
Product Overview .....	4
Unpacking and Installation .....	5
<b>Specifications</b> .....	6
<b>Controls &amp; Displays</b>	
Front Panel .....	8
Rear Panel.....	10
Pin Assignment .....	11
Remote Control .....	12
<b>Playback</b>	
Starting Playback.....	14
Stopping Playback .....	14
Various Playback Functions.....	15
Setting the Top Priority Playback Layer (SACD only) .....	18
<b>Digital to Analog (D/A) Converter</b> .....	19
<b>Use with a Computer</b>	
Use with a Windows Computer .....	20
Apple Computer Compatability .....	20
<b>Service and Care</b>	
Care and Cleaning .....	21
Tube Replacement.....	21
Factory Service.....	21
Non-Warranty Repairs.....	21
<b>Limited Warranty</b> .....	22

# IMPORTANT SAFETY INSTRUCTIONS

---

**WARNING:** The triangle with the lightning flash symbol displayed on the unit advises the user of dangerous un-insulated voltage inside the product's enclosure.

**CAUTION:** To reduce the risk of electric shock, do not remove the cover. There are no user-serviceable parts inside; it is recommended that only qualified personnel service this component.



**ALERT:** The triangle with the exclamation point symbol on the component suggests that the owner refer to important operating and maintenance instructions in the owner's manual.

1. **OWNER'S MANUAL:** Before powering up the equipment, read all safety and operating instructions and follow them as instructed. Retain the safety and operating instructions for future reference.
2. **ATTACHMENTS:** Use only those attachments recommended by the unit manufacturer, as others may cause hazards.
3. **ACCESSORIES:** Do not place the unit on an unstable cart, stand, tripod, bracket, or table. The unit may fall, causing injury to a person or damage to the unit. Mount the unit according to the manufacturer's instructions with the suggested mounting accessory.
4. **WALL OR CEILING MOUNTING:** Mount the unit to a wall or ceiling only in the manner recommended by the manufacturer.
5. **WATER AND MOISTURE:** Do not use the unit near water (for example, near a swimming pool, bath tub, wash bowl, kitchen sink, or laundry tub) or in a damp environment (like a basement or outside in the rain).
6. **OBJECT AND LIQUID ENTRY:** Do not push objects of any kind into the unit through openings as they could touch dangerous voltage points and short-out parts, possibly resulting in a fire or electric shock. Avoid spilling liquid of any kind on the unit. If water or any metal object (such as a paper clip, coin, or staple) accidentally falls inside the unit, disconnect it from the AC power source immediately and contact Cary Audio Design for further instructions.
7. **HEAT:** Position the unit away from heat sources such as radiators, heat registers, stoves, or other units (including amplifiers) that produce heat.
8. **VENTILATION:** Slots and openings in the cabinet create ventilation to protect the component from overheating. These openings on the top and bottom panels must remain unobstructed. Allow at least 6 inches (16cm) of clearance above the unit and an opening behind the unit for airflow. Do not place the unit on a bed, sofa, rug, built-in bookcase, or rack without adequate ventilation.
9. **GROUNDING OR POLARIZATION:** As a safety feature, the unit may be equipped with a polarized alternating current line plug in which one blade is wider than the other. This plug will fit into the power outlet only one way. If you cannot insert the plug fully into the outlet, try reversing the plug. If the plug still will not fit, contact a licensed electrician to update your obsolete outlet. Do not defeat the safety purpose of the polarized plug.
10. **POWER SOURCES:** Operate the unit only from the power source indicated on the marking label. If you are unsure of the type of power supplied to your home, consult your unit dealer or local power company.
11. **POWER CORD PROTECTION:** Arrange power supply cords so that they do not suffer from foot traffic or pinching by items placed on or against them. Pay close attention to cords where plug enter the AC outlet and where they exit from the unit.
12. **LIGHTNING:** For added protection during a lightning storm or when is the component is idle for long periods of time, unplug the unit from the wall outlet and disconnect the antenna or cable system. This will help protect the unit from lightning and power line surge damage.
13. **POWER LINES:** Do not locate an outside antenna system in the vicinity of overhead power lines or other electric light or power circuits. When installing an outside antenna system, take extreme care to avoid touching the power lines or circuits: contact with them could be fatal.
14. **OVERLOADING:** Do not overload wall outlets, extension cords, or integral convenience receptacles as this increases the risk of fire or electric shock.

# IMPORTANT SAFETY INSTRUCTIONS

15. **REPLACEMENT PARTS:** When replacement parts are required, be sure the service technician has used replacement parts specified by the manufacturer or those having the same characteristics as the original parts. Unauthorized substitutions may result in fire, electric shock or other hazards.
16. **SAFETY CHECK:** Upon completion of any service or repairs to the unit, ask the service technician to perform safety checks to ensure the unit is in proper operating condition.

17. **IMPORTANT SAFETY NOTE:**

- Before connecting a new product such as the CD 303T to your audio or home theater system, turn off all other equipment (preferably unplugging them from the AC power source). Many audio components feature automatic turn-on circuits that may activate during an installation, potentially causing damage to electronic components and/or speakers. This type of damage is not covered by product warranties, and Cary Audio specifically disclaims responsibility for any such damage.
- **Power Cord:** The removable power cord provided with your player was specifically designed for use with this product, but other AC cords may be used. Consult your dealer for advice on AC power cords and high quality wire in your system.
- **AC Fuse:** The fuse is located inside the chassis and is not user serviceable. If the unit does not power up, contact an authorized service representative.
- **Wiring:** Cables running inside walls should have the appropriate markings to indicate compliance and listing by the UL, CSA or other standards required by the UL, CSA, NEC or your local building code. Questions about cables inside of walls should be referred to a qualified custom installer, a licensed electrician, or low-voltage contractor.



18. **RECORDING COPYRIGHT:** Recording of copyrighted material for other than personal use is illegal without permission of the copyright holder.

19. **NOTE TO CATV SYSTEM INSTALLER:** This reminder is provided to call the CATV system installer's attention to article 820-40 of the NEC, ANSI/NFPA 70, which provides guidelines for proper grounding and, in particular, specifies that the cable ground shall be connected to the grounding system of the building as close to the point of cable entry as practical.

20. **FCC INFORMATION FOR USER:**

- **CAUTION:** Any changes or modifications not expressly approved by Cary Audio Design could void the user's authority to operate the equipment.
- **NOTE:** This equipment has been tested and found to comply with the limits for a Class B digital device pursuant to Part 15 of the FCC Rules.
- These limits are designed to provide reasonable protection against harmful interference in a residential installation. This equipment generates and can radiate radio frequency energy, and if not installed and used in accordance with the instructions it may cause harmful interference to radio communications. However, there is no guarantee that interference will not occur in a particular installation. If this equipment does cause harmful interference to radio or television reception, which can be determined by turning the equipment off and on, the user is encouraged to try to correct the interference by one or more of the following measures:
  - Reorient or relocate the receiving antenna.
  - Increase the separation between the equipment and receiver.
  - Connect the equipment into an outlet on a circuit different from where the receiver is connected.



21. **OUTDOOR ANTENNA INSTALLATION/SAFE ANTENNA AND CABLE CONNECTION:**

- If an outside antenna or cable system is connected to the equipment, be sure the antenna or cable system is grounded in order to provide protection against built-up static charges and voltage surges. Article 810 of the National Electrical Code, ANSI/NFPA 70 (in Canada, Part 1 of the Canadian Electrical Code) provides information regarding proper grounding of the mast and supporting structure, grounding of the lead-in wire to an antenna discharge unit, size of grounding conductors, location of antenna discharge unit, connection to grounding electrodes and requirements for the grounding electrode.
- Outside antenna system should be located well away from power lines, electric light or power circuits and where it will never come into contact with these power sources if it should happen to fall. When installing an outside antenna, extreme care should be taken to avoid touching power lines, circuits or other power sources as this could be fatal. Because of the hazards involved, antenna installation should be left to a professional.

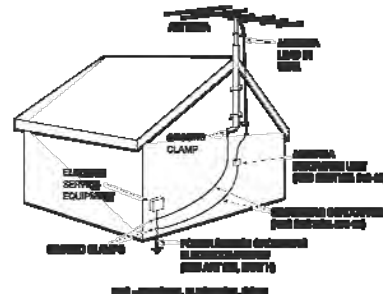

# WELCOME

---

## PRODUCT OVERVIEW

Following the tremendous success of the 303 line of CD players, the new Cary Audio Design CD 303T SACD Professional Version includes the latest in SACD, HDCD and CD playback technology. The CD 303T SACD Professional Version has been completely redesigned from the ground up, modeling the tremendously successful CD 306 Pro. HDCD decoding is accomplished within the new CD 303T using the absolute latest available software. The redeveloped power supply boasts larger power transformers (and more of them) plus higher current regulators creating stronger and higher current-regulated power. For resolution greater than every other machine in its class, the CD 303T's internal word clock frequency has been raised from 11.2896 MHz to 22.5792 MHz during SACD playback.

A new aluminum loader tray modeled after that of the CD 306 Professional Version adds elegance and greater disc handling care. Four Burr Brown 1792u digital to analog (D/A) converter chips run in a true balanced parallel offering an extremely low jitter D/A converter. A word about jitter is in order. The master clock jitter is below measurable levels, utilizing a digital buffer circuit. In other words, the data stream read from the disc is stored in RAM buffer circuits and then released to the D/A conversion. This assures that the component will deliver the sound accurately as it was intended.

Another very important feature of the new CD 303T SACD Professional Version is that SACD playback stays in pure DSD format all the way to the analog outputs. It is not converted to PCM in the CD 303T SACD Professional Version player. Another new feature is that the superior D/A conversion section within the new CD 303T SACD Professional Version may now be used as a stand-alone D/A converter with a choice of three separate digital inputs. These include coaxial, Toslink and USB at bit depths and sample rates up to 24/192 kHz.

The new CD 303T SACD Professional Version will up-sample a Redbook CD disc from 44.1 kHz to 96, 192, 384, 512 or 768 kHz to release all the information available from your disc library. This is the fourth generation of the Cary Audio Design CD 303 series of CD players. The Cary player simply gets the music across to you in a well-balanced, "grab you by the throat," viscerally captivating way. Nothing stands out as being either excessive or lacking. All without a hint of stridency, glare, grit, or other digital nasties, often misinterpreted as detail and resolution. The Cary CD 303T SACD Professional version is another true "tour de force" CD and SACD player in the Cary Audio Design stable.

# WELCOME

---

## UNPACKING AND INSTALLATION

### Unpacking

Your Cary Audio Design product was shipped in a carton particularly designed to protect its contents, and special care has been taken to prevent damage during shipping. Carefully remove your new component from its packing carton and examine it closely for signs of shipping damage. If shipping damage is discovered, document the damage with photographs, contact the transport carrier immediately, and retain the packing as evidence.

We strongly recommend saving all original packing cartons to protect your component for storage or future shipping.

### Power Requirement

The CD 303T SACD Professional Version Transport/Processor is designed to operate from AC mains current. The specified AC voltage is either 110-120 volts or 220-240 volts AC at 50-60 Hz.

### Connections

- Digital Outputs: These outputs send a digital signal and should be connected only to the appropriate digital input of an accompanying component.
- Analog Outputs: These are for connection to the CD or AUX input jacks of an accompanying preamplifier or amplifier.

### Warranty Card

If you are the original purchaser of this unit and you purchased it in the United States, fill out the enclosed warranty registration card and return it to Cary Audio Design within 15 days of your purchase. Warranty restrictions apply. Consult the warranty section of this manual for details. Please keep a copy of the original sales receipt from your Authorized Cary Audio Design dealer to validate the warranty if necessary.

# SPECIFICATIONS

---

Operating the CD 303T SACD Professional Version Transport/Processor is a simple procedure since each unit is designed for long-term stability in virtually any home operating situation. However, if the unit is operated outside the parameters outlined in this owner's manual, damage may occur. Please read this manual carefully before operating your new CD 303T SACD Professional Version.

## GENERAL SPECIFICATIONS

<b>SACD Mechanism</b>	Triple-beam laser, multi-speed SACD transport
<b>Formats</b>	SACD, CD AUDIO (CD-DA), CD-R, CD-RW
<b>Master Clock Jitter</b>	Below measurable levels
<b>Digital Sample Rates (Fs)</b>	44.1, 96, 192, 384, 512 or 768 kHz sample rates for CD playback to the analog audio outputs, 44.1, 88.2, 96, 176.4 or 192 kHz Fs for digital inputs
<b>Digital Filter</b>	Software with HDCD decoding and 8x over sampling Digital Filter
<b>Digital / Analog Converters</b>	4-channel, Burr Brown DSD 1792U
<b>Analog Filter</b>	3rd Order Bessel
<b>Analog Outputs</b>	Balanced XLR, Single-Ended RCA
<b>Digital Outputs</b>	AES/EBU, Coaxial, Toslink operating at Sample Frequency (Fs) from 44.1 kHz 16 bit to 192 kHz 24 bit
<b>Digital Inputs</b>	USB, Coaxial, Toslink operating at Sample Frequency (Fs) from 44.1 kHz 16 bit to 192 kHz 24 bit
<b>Digital Input Sample Rate</b>	44.1 kHz, 48 kHz, 88.2 kHz, 96 kHz, 176.4 kHz or 192 kHz, Accepts 16, 20, or 24 bits
<b>Communication</b>	RS232 full remote configuration interface
<b>Power Input</b>	Configured at factory for either 110-120 or 220-240 VAC, 50-60 Hz
<b>Power Consumption</b>	80 Watts
<b>Tubes</b>	Four 12AU7

# SPECIFICATIONS

---

## AUDIO (CD)

<b>Frequency Range</b>	2 Hz - 22 kHz (44.1 kHz)
<b>Amplitude Linearity</b>	0.1 dB (20 Hz – 20 kHz)
<b>Phase Linearity</b>	3 degrees (20 Hz - 20 kHz)
<b>Dynamic Range</b>	121 dB (1 kHz)
<b>Signal-to-Noise Ratio</b>	117 dB (1 kHz)
<b>Channel Separation</b>	106 dB (1 kHz)
<b>Total Harmonic Distortion</b>	0.0004% (1 kHz)
<b>Audio Output Level</b>	3.0V RMS (220 $\Omega$ output impedance)
<b>Balance</b>	6.0V RMS (440 $\Omega$ output impedance)

## AUDIO (SACD)

<b>Frequency Range</b>	2 Hz - 100 kHz (2.822 MHz)
<b>Signal system</b>	1 bit DSD
<b>Sampling frequency</b>	2.822 MHz
<b>Dynamic Range</b>	123 dB
<b>DSD System Clock</b>	Frequency 22.5792 MHz
<b>Signal-to-Noise Ratio</b>	117 dB
<b>Audio Output Level</b>	3.0V RMS (220 $\Omega$ output impedance)
<b>Balanced</b>	6.0V RMS (440 $\Omega$ output impedance)



# CONTROLS AND DISPLAYS

## FRONT PANEL

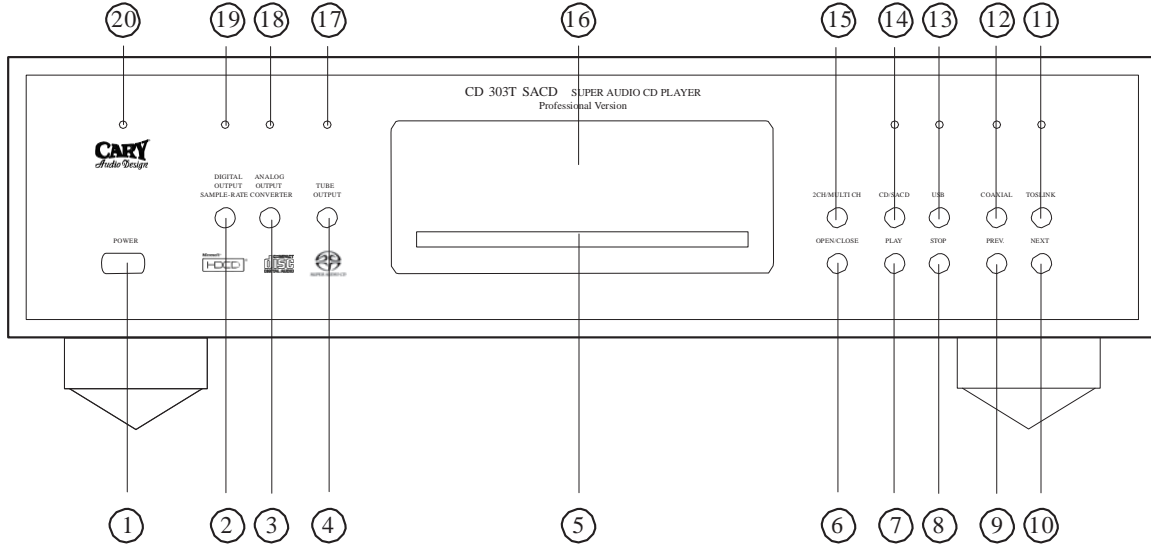

### 1. POWER

Press once to turn the power on.  
Press again to turn power off.

### 2. DIGITAL OUTPUT SAMPLE-RATE CONVERTER (CD only)

This switches the digital output sample-rate converter mode.  
44.1 kHz ---> 96 kHz ---> 192 kHz --->

### 3. ANALOG OUTPUT SAMPLE RATE COVERTER (CD only)

This switches the analog output sample-rate converter mode.  
44.1 kHz ---> 96 kHz---> 192 kHz ---> 384 kHz ---> 512 kHz---> 768 kHz --->

### 4. TUBE

This switches the analog output sections between the vacuum tube and the solid-state section.

### 5. DISC HOLDER

Load discs here.

### 6. DISC HOLDER OPEN/CLOSE

This opens and closes the disc holder.

### 7. PLAY

Press this button to start playback of the disc.

# CONTROLS AND DISPLAYS

---

## **8. STOP**

Press this button to stop playback.

## **9. AUTOMATIC SEARCH REVERSE**

Press this button to return the pickup to the beginning of the current track. Press again to return to previous tracks.

## **10. AUTOMATIC SEARCH FORWARD**

Press this button to move the pickup forward to the beginning of the next track. Press again to move ahead to other tracks.

## **11. EXTERNAL IN TOSLINK (OPTICAL)**

Press to select the program source connected to the digital input jack TOSLINK (Optical).

## **12. EXTERNAL IN COAXIAL**

Press to select the program source connected to the digital input jack COAXIAL.

## **13. EXTERNAL IN USB**

Press to select the program source connected to the digital input jack PC-USB.

## **14. CD/SACD**

Press this button to select the source to be played.

## **15. 2CH/MULTI CHANNEL**

Press to select the layer of the 2-channel or multi-channel in the SACD.

## **16. ALPHANUMERIC DISPLAY**

This twenty-character display provides a wide range of information concerning the operation of the CD 306 SACD Professional Version.

## **17. TUBE SECTION USED INDICATOR**

This indicator lights when the tube section is used in output ports.

## **18. ANALOG OUTPUT SAMPLE RATE CONVERTER INDICATOR**

This indicator lights when the analog output sample rate converter function is on.

## **19. DIGITAL OUTPUT SAMPLE RATE CONVERTER INDICATOR**

This indicator lights when the digital output sample rate converter function is on.

## **20. POWER INDICATOR**

This indicator is illuminated when the player is attached to AC mains.

# CONTROLS AND DISPLAYS

## REAR PANEL

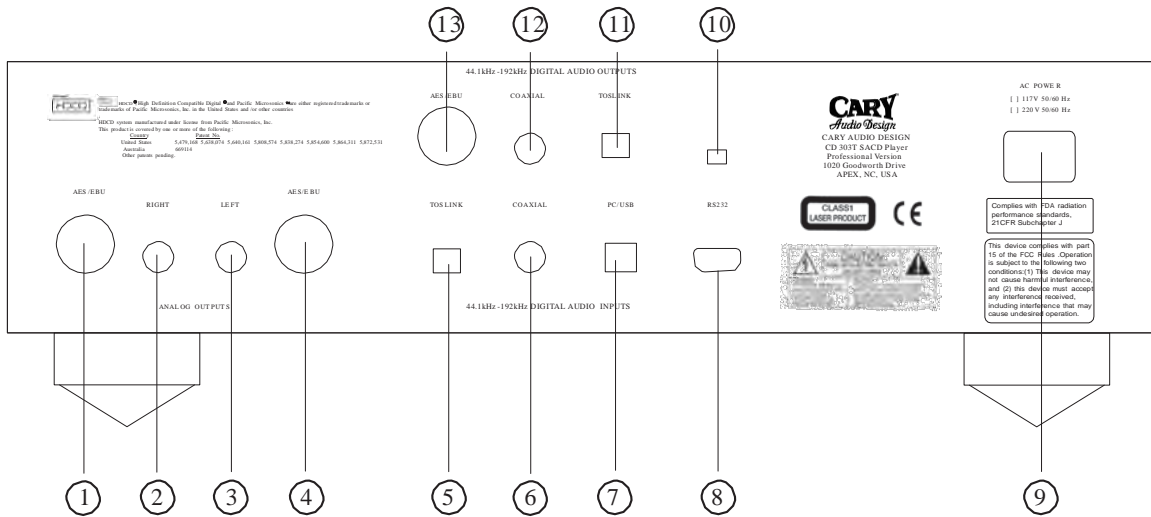

- 1. RIGHT CHANNEL ANALOG OUTPUT JACK (AES/EBU BALANCED)**  
Use this jack for connection to the amplifier/preamplifier balanced input jack.
- 2. RIGHT CHANNEL ANALOG OUTPUT JACK (RCA UNBALANCED)** Use this jack for connection to the amplifier/preamplifier RCA unbalanced input jack.
- 3. LEFT CHANNEL ANALOG OUTPUT JACK (RCA UNBALANCED)**  
Use this jack for connection to the amplifier/preamplifier RCA unbalanced input jack.
- 4. LEFT CHANNEL ANALOG OUTPUT JACK (AES/EBU BALANCED)**  
Use this jack for connection to the amplifier/preamplifier balanced input jack.
- 5. DIGITAL INPUT JACK (TOSLINK)**  
44.1 kHz -192 kHz digital data input to this jack.
- 6. DIGITAL INPUT JACK (COAXIAL)**  
44.1 kHz -192 kHz digital data input to this jack.
- 7. DIGITAL INPUT JACK (PC-USB)**  
44.1 kHz -192 kHz digital data input to this jack.

# CONTROLS AND DISPLAYS

---

## 8. RS 232 JACK

Use this jack for connection to computer control.

## 9. POWER INPUT (AC IN)

Connect to AC mains using the included power supply cord.

## 10. SOFTWARE UPGRADE PORT

## 11. DIGITAL OUTPUT JACK (TOSLINK)

44.1 kHz – 192 kHz digital data output from this jack.

With SACD discs, no digital signals are delivered from Super Audio CD discs.

## 12. DIGITAL OUTPUT JACK (COAXIAL)

44.1 kHz - 192 kHz digital data output from this jack.

With SACD discs, no digital signals are delivered from Super Audio CD discs.

## 13. DIGITAL OUTPUT JACK (AES/EBU)

44.1 kHz-192 kHz digital data output from this jack.

With SACD discs, no digital signals are delivered from Super Audio CD discs.

## PIN ASSIGNMENT

The pin assignments of all of the XLR-type male analog outputs, the XLR-type male digital output, and XLR-type female digital inputs are as follows:

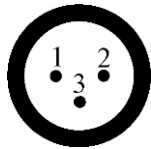

Pin 1: Signal ground  
Pin 2: Signal + (non-inverting) Pin  
3: Signal - (inverting)  
Connector ground lug: chassis ground

Refer to the owner's manual for the other components in your audio system to verify that the XLR pin assignments of its input connectors correspond to the CD 303T SACD Professional Version. If they are different, wire the XLR cable so that the appropriate XLR output pin connects to the equivalent XLR input pin.

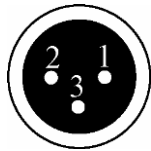

Pin 1: Signal ground  
Pin 2: Signal + (non-inverting) Pin  
3: Signal - (inverting)  
Connector ground lug: chassis ground

# CONTROLS AND DISPLAYS

## REMOTE CONTROL

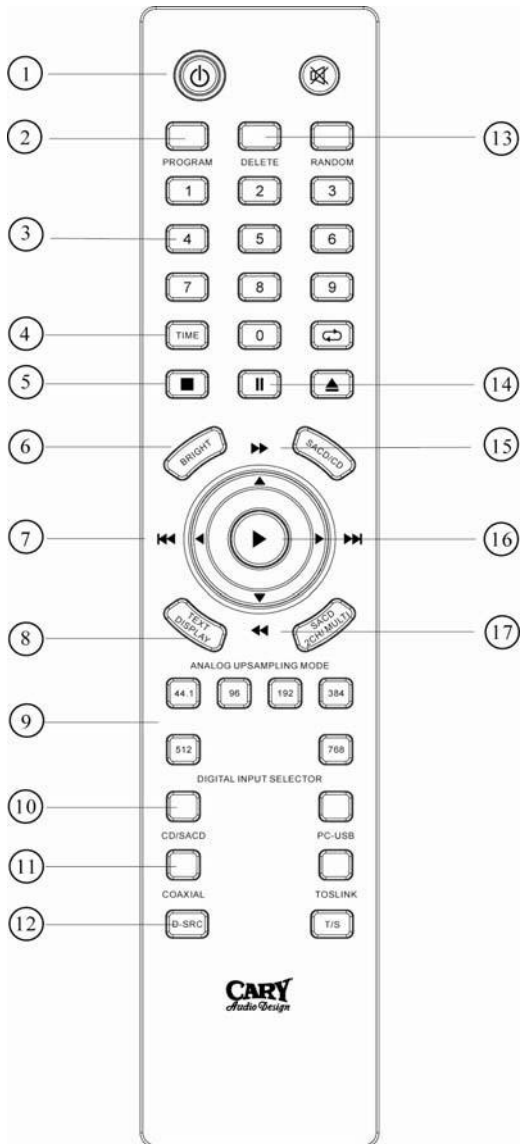

1. **POWER:** Use to turn the power on and off.
2. **PROGRAM:** Preset tracks to be played by keying in track numbers. When using PROGRAM function, the player must be in STOP mode.
3. **NUMBER:** Use the number buttons to select a track. Playback starts from the selected track.
4. **TIME:** Displays the remaining time of a track or it displays the total remaining time of a disc.
5. **STOP:** Use to stop play.
6. **BRIGHT:** Use to select the player display brightness level.
7. **PREVIOUS:** Use to jump to the start of the previous track.
8. **TEXT DISPLAY:** Use this function to display the text information on the disc.
9. **ANALOG UPSAMPLING MODE:** Use to select the analog sample-rate converter mode.
10. **CD/SACD:** Use to select the source material.
11. **COAXIAL:** Use to select the program source connected to the digital input jack (COAXIAL).
12. **D-SRC:** Use to select the digital sample-rate converter mode.
13. **DELETE:** Use to clear a program.
14. **PAUSE:** Use to pause and resume play.
15. **FORWARD:** Use to search for a passage.
16. **PLAY:** Use to start play.
17. **REVERSE:** Use to search for a passage.

# CONTROLS AND DISPLAYS

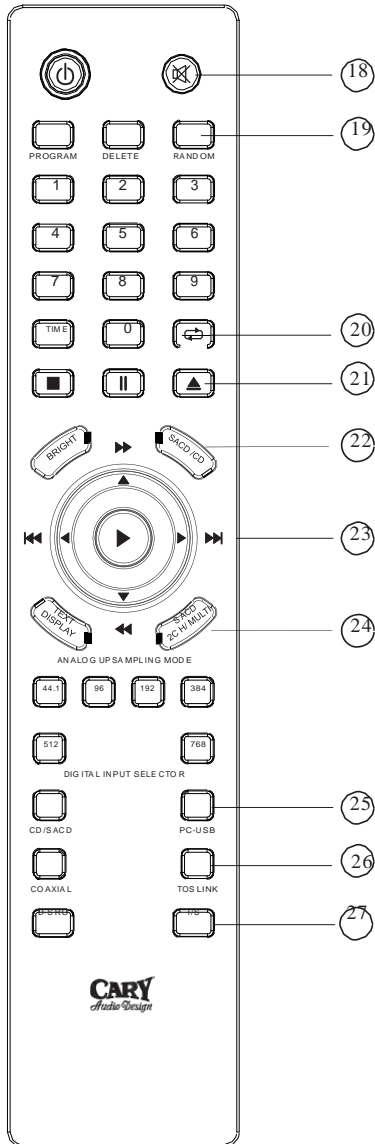

18. **MUTE:** Use to mute and resume sound.
19. **RANDOM:** Use to play all the tracks on the disc once in random order.
20. **REPEAT:** Use to repeat play. Press once for single track, press a second time to repeat all tracks, and press a third time to clear.
21. **OPEN/CLOSE:** Use to open and close the disc holder.
22. **CD/SACD:** Use to select the SACD layer or CD layer of a hybrid disc.
23. **NEXT:** Use to select another track during play.
24. **SACD 2CH/MULTI CH:** Use to select the 2-channel or multi-channel layer on the SACD disc.
25. **PC-USB:** Use to select the program source connected to the PC-USB input jack.
26. **TOSLINK:** Use to select the program source connected to the digital input jack (TOSLINK).
27. **T/S:** Use to select the analog outputs sections between the vacuum tube section and solid-state section.

# PLAYBACK

## STARTING PLAYBACK

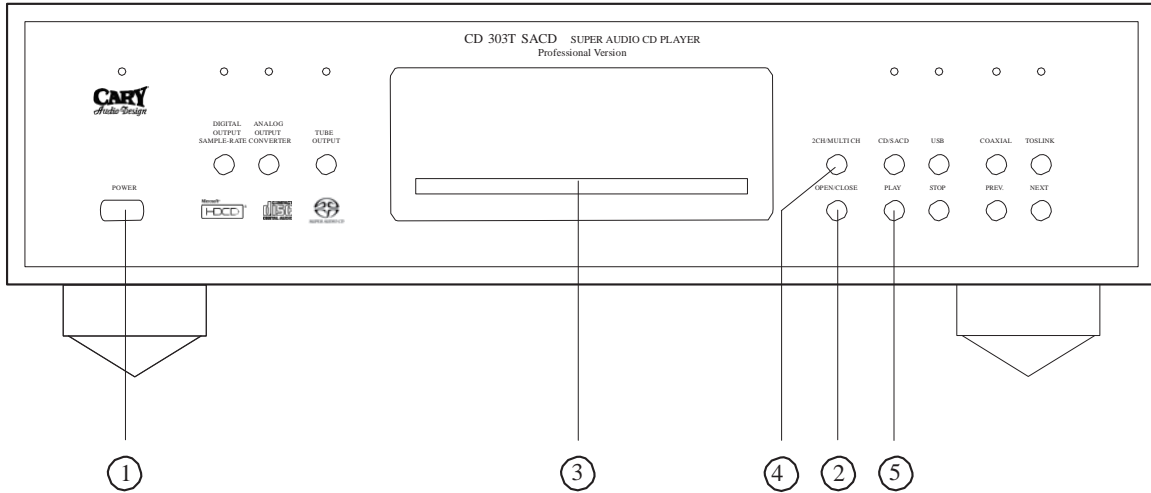

1. Press the POWER button to turn the power on.
2. Press the OPEN/CLOSE button.  
The disc holder opens.
3. Load the disc you want to play.
4. For SACD, use the 2CH/MULTI CHANNEL button to set the layer to be played, as necessary.
5. Press the PLAY button.  
Playback starts then stops automatically after the last track on the disc has been played.

## STOPPING PLAYBACK

To stop playback, press the STOP button.

# PLAYBACK

## VARIOUS PLAYBACK FUNCTIONS (REMOTE CONTROL UNIT ONLY)

### Playing a Specific Track

[Direct Play]



1. Use the number buttons and "+ 10" button to select the desired track.

Playback starts from the selected track.

### Stopping Playback Temporarily

[Pause]

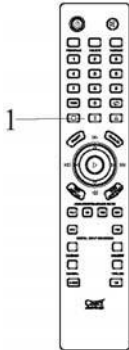

1. During playback, press the PAUSE button on the remote control unit.
2. To resume playback from the position at which the disc is paused, press PLAY button.

### Automatic Search

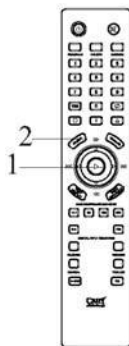

1. Press the NEXT button.
  - Press the button more than once to move ahead to the beginning of subsequent tracks.
  - When the NEXT button is pressed during random playback, the next track is selected at random and played.
2. Press the PREV button.
  - Press the button more than once to move back to the beginning of previous tracks.



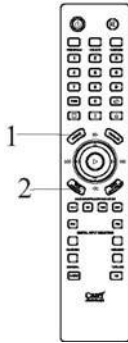

# PLAYBACK

## Finding the Desired Spot While Listening to the Sound



Use this function to skip forward or backward while listening to the sound. This function comes in handy for finding a particular spot in the middle of long tracks.

1. During playback, press and hold in the  button.
  - When the button is released, normal playback resumes from that point.
2. During playback, press and hold in the  button.
  - When the button is released, normal playback resumes from that point.

## Playing the Tracks in the Desired Order

### [Programmed Play]

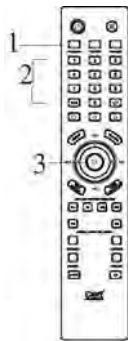

Use this function to select the desired tracks on the disc and play them in the desired order. Up to thirty-five tracks can be programmed.

1. In the stop mode, press the PROGRAM button.
2. Press the number to select the track to be programmed.
  - For example, to program the 3rd and 9th tracks to play, press PROGRAM, 3, PROGRAM, 9.
3. Press the PLAY button.
  - The tracks are played in the programmed order.

## Playing the Tracks in Random Order

### [Random Play]



Use this function to play all the tracks on the disc once in random order.

1. In the stop mode, press the RANDOM button.
  - The RANDOM indicator lights.
  - A track is selected automatically and playback begins.
  - To cancel random playback, press the RANDOM button while in the stop mode. Normal playback resumes.

# PLAYBACK

---

## Repeat Play

## [Repeat Play]

This button is used to play all the tracks repeatedly using this sequence:



1. In the PLAY mode, press the REPEAT button twice.
  - The "RepAll" indicator becomes illuminated.
  - To cancel the all-track repeat mode, press the REPEAT button three times.

Also, this button is used to play a single track repeatedly using this sequence:

2. During playback, press the REPEAT button once.
  - The "Rep-1" indicator lights.
  - To cancel the one-track repeat mode, press the REPEAT button four times.

## To Display Text (SACD CD only)

With SACDs that contain text information, the text information included on the disc can be displayed while in either the stop or play mode.

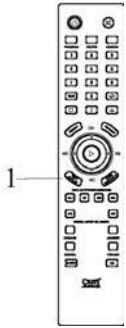

1. Press the TEXT DISPLAY button while in the stop mode.
  - The album title scrolls on the display.
2. Then press the PLAY button.
  - The title of the track currently playing scrolls on the display.
  - When a track is switched while its track title is being displayed, the new track's title is scrolled.
  - "NO TEXT" is displayed if the TEXT DISPLAY button is pressed when a disc not containing text information is loaded.

# PLAYBACK

## SETTING THE TOP PRIORITY PLAYBACK LAYER (SACD ONLY)

The factory default setting for the top priority playback of the SACD disc layer is the SACD (stereo) layer. The user can change the SACD disc layer for top priority playback after the disc is loaded.

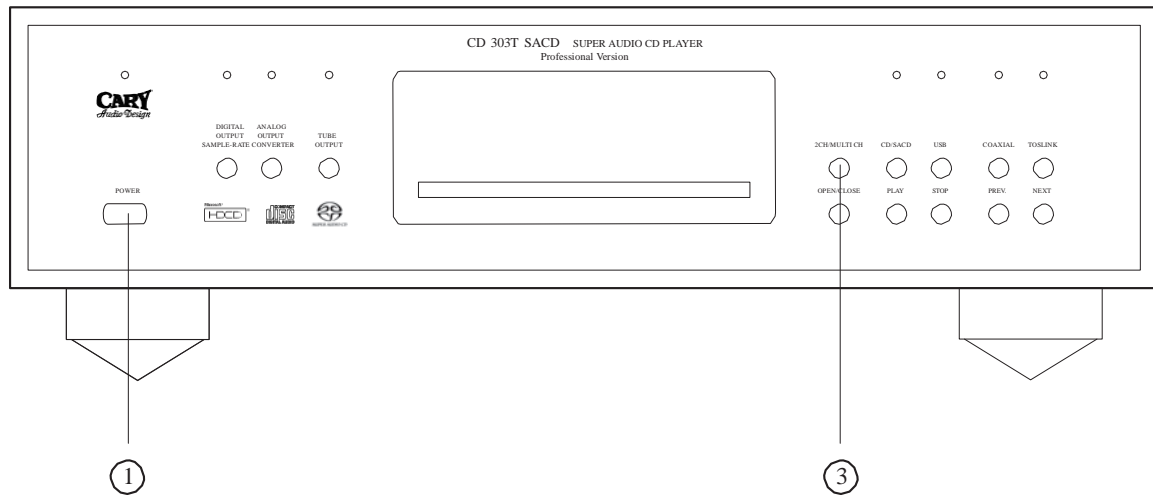

1. Press the POWER button to turn the power on.
2. Check that the disc is loaded.
3. Press the 2CH/MULTI CHANNEL button and switch to the desired layer.
  - When an SACD disc is loaded after the setting has been made, the contents recorded on the set layer are displayed.
  - If a disc not containing the layer set for top priority playback is loaded, the contents recorded on another layer are displayed automatically.
  - This setting is stored in the memory and is not cleared, even when the disc holder is opened or closed or the power is turned off. To change the setting, repeat the procedure above.

# DIGITAL TO ANALOG CONVERTER

## USING AS A DIGITAL TO ANALOG (D/A) CONVERTER

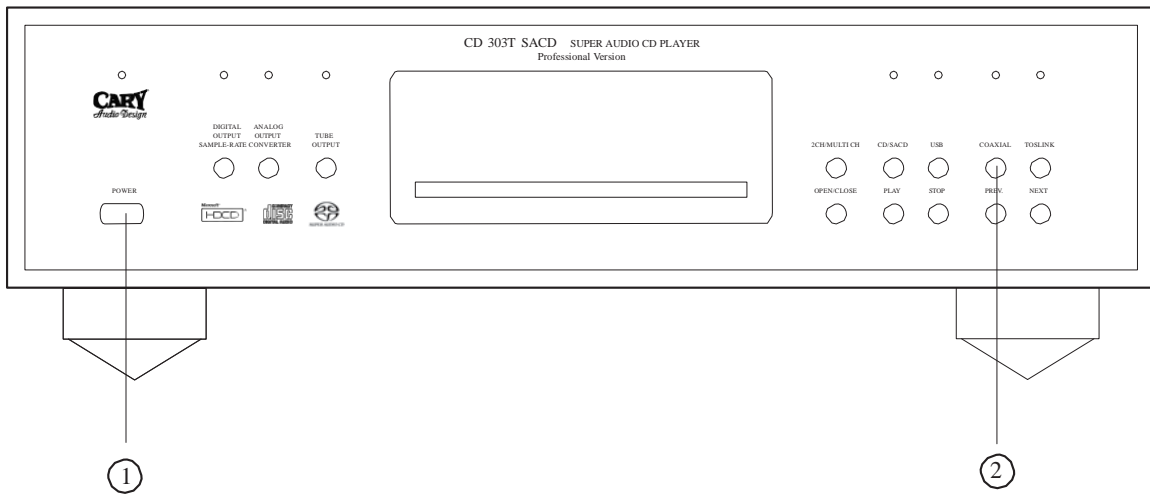

1. Press the POWER button to turn the power on.
2. Press the desired digital input button: USB, COAXIAL, or TOSLINK button.
3. At startup, the USB / COAXIAL / TOSLINK displays the following:
  - A-OUT: NONE
  - D-IN: NONE
  - D-OUT: NONE

After initializing, the Analog-Out is the first to appear on the display, then the external digital input sampling frequency appears. The USB / COAXIAL / TOSLINK displays will show as follows:

- A-OUT: 192 kHz
- D-IN: 192 kHz
- D-OUT: 192 kHz

Digital input signal can be output in digital format and analog format.

Only linear PCM signals with a sampling frequency of 32 kHz, 44.1 kHz, 48 kHz, 88.2 kHz, 176.4 kHz or 192 kHz can be played on this setting. Do not input any digital signal other than linear pulse code modulation (PCM) signals such as CD-ROM, Dolby Digital, and DTS signals. Doing so will generate output noise that could damage the speakers.

When the digital sampling frequency is switched, the muting circuit is activated for 1 or 2 seconds, so the sound will stop momentarily and then start again each time the digital sample rate is changed.

# USE WITH A COMPUTER

---

## USE WITH A WINDOWS COMPUTER

If your Windows computer does not meet these minimum requirements, you may experience lagging of audio and possible freezing of your computer during operation:

- Microsoft Windows XP (with SP2) or Microsoft Windows Vista or Microsoft Windows 7
- Available USB 2.0 port (High speed for USB2.0)
- Intel Pentium 4 processor or equivalent AMD Athlon processor
- Motherboard with Intel or VIA chipset
- 5400 RPM or faster hard disc drive (7200 RPM or Faster with 8MB cache recommended)
- 256MB or more of RAM (512MB recommended)

## PC-DRIVE INSTALLATION

To use the CD303T SACD Professional Version USB port efficiently on any computer, it is important to install all the necessary drivers from the Cary Audio website. We advise users to read all instructions carefully before beginning the installation process, as they will be asked to disconnect and reconnect their CD303T SACD Professional Version.

Starting the PC Driver Installation:

1. Download the CARY USB Driver from [www.caryaudio.com](http://www.caryaudio.com).
2. Unzip the CARY USB Driver.
3. Double click CARY USB setup.exe to begin the installation.
4. Click NEXT to install the CARY USB Driver on your computer.
5. Click INSTALL to begin the installation.
6. Click FINISH to complete the setup wizard.
7. Connect your USB cable from the component to your computer.
8. After connecting the component to your PC, the computer should make a tone signifying that a new device has been connected.
9. The PC Driver installation is complete and the component can be used.

## APPLE COMPUTER COMPATABILITY

Apple computers can transmit a 24/192 kHz signal to the CD 303T over the optical inputs. Most of the recent model Apple computers contain a mini optical digital audio output that can transmit 24/192 kHz high-resolution audio files to the CD 303T.

However, a USB driver capable of accepting a 24/192 kHz signal has not yet been created for Apple computers. Due to its sophistication and its ability to receive a 24/192 kHz signal, the USB input on the CD 303T was specifically written for Windows-based computers.

## SERVICE AND CARE

---

### CARE AND CLEANING

Unplug the unit from the wall outlet. Clean the cabinet housing and front panel of the CD 303T SACD Professional Version with a soft cloth and a glass cleaner (such as Windex). Removing the cover during cleaning is not advised. The frequency of cleaning will vary based on the cleanliness of the environment and the number of hours the CD 303T SACD Professional Version is operated.

### TUBE REPLACEMENT

The CD 303T SACD Professional Version has four 12AU7 tubes for audio gain and output buffering. They should provide years of trouble free performance. You may want to experiment by "rolling" some vintage 12AU7 tubes in the CD 303T SACD Professional Version. You can access the four tubes by opening the small panel on the top of the chassis. Be sure the unit is unplugged and cool before opening the top panel and removing any tubes. Gently pull the tubes out by pulling straight up. When inserting tubes, be careful to line the pins of the tube with the socket in the CD 303T SACD Professional Version.

### FACTORY SERVICE

Careful consideration has been given to the design of your CD 303T SACD Professional Version to keep maintenance problems to a minimum. Any problems or requests for service should be referred to our Customer Service Department at 919.355.0010. Do not return the CD 303T SACD Professional Version to the factory without a return authorization number (RA) from the Customer Service Department. Refer to the next section for details about returning equipment to Cary Audio Design.

Should the unit be lost or damaged in shipment, Cary Audio Design will assume no responsibility if the shipping company refuses to pay for damage due to your improper packing or lack of insurance. Please use the original shipping carton for shipping the player.

### NON-WARRANTY REPAIRS

Cary Audio Design will provide repair service for its products charging on a time and expense basis. Please call Cary Audio Design at 919.355.0010 for more information about out-of-warranty service and repair fees.

# LIMITED WARRANTY

---

## **Cary Audio Warrants to the original United States purchaser for use in the United States the Following Cary Audio Products for the Periods Indicated:**

1. Power Amplifiers, Integrated Amplifiers, Surround Sound Processors, and Preamplifiers have a three (3) year parts and labor warranty from the date of the original purchase from Cary Audio.
2. CD or SACD players, DVD players, or Music Servers have an eighteen (18) month parts and labor warranty from the date of the original purchase from Cary Audio.
3. Vacuum tubes, if any are used in the component, are offered a 90-day exchange policy against defects with the exception of the CAVT 300B vacuum tube that has a one (1) year exchange policy from the date of the original purchase from Cary Audio.

## **What is Covered and What is Not Covered**

Except as specified below, this warranty covers parts and labor to correct all defects in materials and workmanship. The following are not covered by the warranty:

1. Damage, deterioration, malfunction or failure to meet performance specifications resulting from:
  - a. Accident, acts of nature, misuse, abuse, neglect or unauthorized product modifications
  - b. Improper installation, removal or maintenance, or failure to follow instructions supplied with the product.
  - c. Repair or attempted repair by anyone not authorized by Cary Audio to repair the product.
  - d. Any shipment of the product (claims must be presented to the carrier).
  - e. Any cause other than a product defect.
2. Cleaning, initial set-up, check-ups with no defects found, or charges incurred for installation, removal or reinstallation of the product.
3. Any product, on which the serial number has been defaced, modified or removed.
4. Batteries.
5. Accessories, including but not limited to, batteries, cables, mounting hardware and brackets, cleaning accessories, antenna and detachable power cords.
6. Warranty is void if purchase was made from anyone other than an authorized Cary Audio dealer.

## **Who May Enforce the Warranty?**

This warranty extends to products purchased directly from Cary Audio or an authorized Cary Audio dealer. Purchasers should inquire of the dealer regarding the nature and extent of the dealer's warranty, if any.

To obtain such warranty service, the original purchaser must complete and send in the Warranty Registration Card within 15 days of purchase.

# LIMITED WARRANTY

---

## What Will We Pay For?

We will pay for all labor and material expenses for items covered by the warranty. Payment of shipping charges is discussed in the next section of this warranty.

## How You Can Get Service?

In the event that the owner needs to return the unit to Cary Audio for service or repair of a possible defect, he must follow the following steps:

1. Contact Cary Audio at 919-355-0010 to obtain a Return Merchandise Authorization (RMA) number prior to shipping; include this number with the package
2. Submit a copy of the original sales receipt; blank receipts will not validate the limited warranty for service by Cary Audio. The original sales receipt must contain the following information:
  - a. The authorized Cary Audio dealer's name
  - b. The date of purchase
  - c. The unit's sales price
  - d. The buyer's name and address
  - e. Describe in detail the problem.
  - f. Note the unit's model number and serial number.
3. Deliver by either of these methods:
  - a. With all freight and insurance charges prepaid and in its original packing container or equivalent, ship the component to Cary Audio, 1020 Goodworth Drive Apex, NC 27539.
  - b. Hand-deliver the product to Cary Audio (address noted above) or the nearest authorized service facility.

## Limitation of Implied Warranties

All implied warranties, including warranties of merchantability and fitness for particular purchase, are limited in duration to the length of this warranty.

## Exclusion of Damages

Cary Audio's liability for any defective product is limited to repair or replacement of the product at Cary Audio's option. Cary Audio shall not be liable for damage to other products caused by any defects in Cary Audio products, damages based upon inconvenience or loss of use of the product, or any other damages, whether incidental, consequential, or otherwise.



# LIMITED WARRANTY

---

## **How State Law Relates to the Warranty**

Some states do not allow limitations on how long an implied warranty lasts and/or do not allow the exclusion or limitation of incidental or consequential damages, so the above limitations or exclusions may not apply to you.

This warranty gives you specific legal rights, and you may also have other rights which vary from state to state.

## **International Purchasers (Export Markets)**

Cary Audio warrants its merchandise to purchasers within the United States exclusively for use within the United States. It provides no other warranties, expressed or implied. If you are living outside of the United States, please consult your local dealer or distributor to determine the details of your local warranty.

**CARY AUDIO DESIGN**

1020 Goodworth Drive, Apex, NC 27539  
phone 919-355-0010  
fax 919-355-0013  
[www.caryaudio.com](http://www.caryaudio.com)