

***210D***

---

➤ *Owner's/Installation Guide*

## *limited lifetime consumer warranty*

For a period of one calendar year from the date of purchase of this auto-security device, Directed Electronics, Inc. promises to the ORIGINAL PURCHASER to repair or replace (with a comparable reconditioned model), free of cost, any electronic control module which proves to be defective in workmanship or material under normal use, SO LONG AS THE SYSTEM WAS SOLD, INSTALLED, AND SERVICED BY A PROFESSIONAL AUTO INSTALLER, AND REMAINS IN THE CAR IN WHICH THE SYSTEM WAS ORIGINALLY INSTALLED. If warranty service is necessary you must have a clear copy of your sales receipt containing all of the information shown on the following page.

After the first calendar year, from the date of purchase of this auto-security device, Directed Electronics, Inc., promises to the ORIGINAL PURCHASER to repair or replace (with a comparable reconditioned model) any electronic control module which proves to be defective in workmanship or material under normal use FOR A CHARGE OF \$45.00, SO LONG AS THE SYSTEM WAS SOLD, INSTALLED, AND SERVICED BY A PROFESSIONAL AUTO INSTALLER, AND REMAINS IN THE CAR IN WHICH THE SYSTEM WAS ORIGINALLY INSTALLED. If warranty service is necessary you must have a clear copy of your sales receipt containing all of the information shown on the following page.

This warranty contains the entire agreement relating to warranty and supersedes all previous and contemporaneous representations or understandings, whether written or oral. IN ANY EVENT, DIRECTED ELECTRONICS, INC. IS NOT LIABLE FOR THE THEFT OF THE VEHICLE AND/OR ITS CONTENTS.

This warranty is void if the product has been damaged by accident, unreasonable use, neglect, improper service or other causes not arising out of defects in materials or construction. This warranty is nontransferable and does not apply to any unit that has been modified or used in a manner contrary to its intended purpose and does not cover batteries. The unit in question must be returned to the manufacturer, postage prepaid. This warranty does not cover labor costs for the removal, diagnosis, troubleshooting or reinstallation of the unit. For service on an out-of-warranty product a flat rate fee by model is charged. Contact your authorized dealer to obtain the service charge for your unit.

These systems are a deterrent against possible theft. Directed Electronics, Inc. is not offering a guarantee or insuring against the theft of the automobile or its contents and disclaims any liability for the theft of the vehicle and/or its contents. Directed Electronics does not authorize any person to create for it any other obligation or liability in connection with this security system.

TO THE MAXIMUM EXTENT ALLOWED BY LAW, ANY AND ALL WARRANTIES ARE EXCLUDED BY THE MANUFACTURER AND EACH ENTITY PARTICIPATING IN THE STREAM OF COMMERCE THEREWITH. THIS EXCLUSION INCLUDES BUT IS NOT LIMITED TO THE EXCLUSION OF ANY AND ALL WARRANTY OF MERCHANTABILITY AND/OR ANY AND ALL WARRANTY OF FITNESS FOR A PARTICULAR PURPOSE AND/OR ANY AND ALL WARRANTY OF NON-INFRINGEMENT OF PATENTS, IN THE UNITED STATES OF AMERICA AND/OR ABROAD. NEITHER THE MANUFACTURER OR ANY ENTITIES CONNECTED THEREWITH SHALL BE RESPONSIBLE OR LIABLE FOR ANY DAMAGES WHATSOEVER, INCLUDING BUT NOT LIMITED TO ANY CONSEQUENTIAL DAMAGES, INCIDENTAL DAMAGES, TOWING, REPAIR, REPLACEMENT, DAMAGES FOR LOSS OF TIME, LOSS OF EARNINGS, COMMERCIAL LOSS, LOSS OF ECONOMIC OPPORTUNITY AND THE LIKE. NOTWITHSTANDING THE ABOVE, MANUFACTURER DOES OFFER A LIMITED WARRANTY TO REPLACE OR REPAIR THE CONTROL MODULE AS DESCRIBED ABOVE. Some states do not allow limitations on how long an implied warranty will last or the exclusion or limitation of incidental or consequential damages. This warranty gives you specific legal rights, and you may also have other rights which vary from state to state.

**IMPORTANT NOTE:**

This product warranty is automatically void if its date code or serial number is defaced, missing, or altered. This warranty will not be valid unless you have completed the warranty card and mailed it to Directed Electronics, Inc. within 10 days after purchase to the address listed on the warranty registration card.

Make sure you have all of the following information from your dealer:

A clear copy of the sales receipt, showing the following:

- > Date of purchase
- > Your full name and address
- > Authorized dealer's company name and address
- > Type of alarm installed
- > Year, make, model and color of the automobile
- > Automobile license number
- > Vehicle identification number
- > All security options installed on automobile
- > Installation receipts

# *table of contents*

---

<b>limited lifetime consumer warranty</b> .....	<b>i</b>
<b>what is included</b> .....	<b>3</b>
<b>installation tools</b> .....	<b>3</b>
<b>important information</b> .....	<b>4</b>
system maintenance .....	4
your warranty .....	5
fcc/id notice .....	5
<b>primary harness (H/1), 12-pin connector</b> .....	<b>6</b>
<b>installation</b> .....	<b>7</b>
step 1 .....	8
step 2 .....	9
step 3 .....	10
step 4 .....	12
step 5 .....	13
step 6 .....	14
step 7 .....	16
step 8 .....	16
step 9 .....	17
step 10 .....	18
step 11 .....	18
step 12 .....	19
<b>transmitter functions</b> .....	<b>20</b>
standard configuration .....	21
<b>transmitter/receiver learn routine</b> .....	<b>22</b>
<b>operating settings learn routine</b> .....	<b>25</b>
to access another feature .....	26
to exit the learn routine .....	27
<b>features menu</b> .....	<b>28</b>
<b>feature descriptions</b> .....	<b>29</b>
<b>using your system</b> .....	<b>30</b>
arming with transmitter .....	30
arming without a transmitter .....	30
disarming with transmitter .....	31
disarming without a transmitter .....	32
panic mode .....	32
silent mode .....	33
valet mode .....	33
manual valet mode .....	34
remote valet .....	34

<b>diagnostics</b> .....	<b>35</b>
arming diagnostics .....	35
disarming diagnostics .....	36
system status chirps .....	37
table of zones .....	38
nuisance prevention circuitry .....	38
<b>code hopping™ re-synchronize</b> .....	<b>40</b>
<b>troubleshooting</b> .....	<b>40</b>
<b>glossary of terms</b> .....	<b>42</b>
<b>security &amp; convenience expansions</b> .....	<b>44</b>
<b>wiring quick reference diagram</b> .....	<b>46</b>
<b>notes</b> .....	<b>47</b>

## *what is included*

---

- On board Double Guard Shock Sensor
- Control Module
- Two 3-Button Transmitters
- 12-Pin Main H/1 Harness
- Plug-in Status LED
- Plug-in Valet®/Program Button
- 514 Revenger Siren
- Starter Kill Harness

## *installation tools*

---

- Digital Multi-Meter
- Drill
- $\frac{9}{32}$  and  $\frac{5}{16}$  Drill Bits
- Screwdrivers  
(Phillips and Flathead)
- Wire Stripper
- Solder Iron
- Electrical Tape
- Pliers
- Crimping Tool



**note:** The installation tools required will vary depending on your vehicle.

## *important information*

---

Congratulations on the purchase of your security entry system. This system will allow convenient access to your vehicle with the push of a button, as well as other optional features. Properly installed, this system will provide years of trouble-free operation.

Please take the time to carefully read this Owner's/Install Guide in its entirety and watch the Rattler Do-It-Yourself Installation Video prior to installing your system.

You can print additional or replacement copies of this manual by accessing the Directed web site at [www.diyrattler.com](http://www.diyrattler.com).

**important!** If you are not comfortable working with electronics or unfamiliar with the tools required, please contact your local dealer for advice or ask to have the remote start professionally installed to avoid costly damages. Failure to properly install the security system may result in property damage, personal injury, or both.

### → **system maintenance**

The system requires no specific maintenance. Your remote is powered by a miniature 3-volt battery (type CR2032) that will last approximately one year under normal use. When the battery begins to weaken, operating range will be reduced and the LED on the remote will dim.

**→ your warranty**

Your warranty registration must be completely filled out and returned within 10 days of purchase. Your product warranty will not be validated if your warranty registration is not returned. Please note that it is necessary to keep your proof of purchase.

**→ fcc/id notice**

This device complies with Part 15 of FCC rules. Operation is subject to the following conditions: (1) This device may not cause harmful interference, and (2) This device must accept any interference received, including interference that may cause undesirable operation.

Changes or modifications not expressly approved by the party responsible for compliance could void the user's authority to operate this device.



## *primary harness (H/1), 12-pin connector*

---

H1/1	ORANGE	(-) 500 mA Ground-When-Armed Output
H1/2	WHITE	(+) Light Flash Output
H1/3	WHITE/BLUE	(-) 200 mA Channel 3 Validity Output
H1/4	BLACK/WHITE	(-) 200 mA Dome light Supervision Output
H1/5	GREEN	(-) Door Trigger Input, Zone 3
H1/6	BLUE	(-) Instant Trigger, Zone 1
H1/7	VIOLET	(+) Door Trigger Input, Zone 3
H1/8	BLACK	(-) Chassis Ground Input
H1/9	YELLOW	(+) Ignition Input, Zone 5
H1/10	BROWN	(+) Siren Output
H1/11	RED	(+) 12V Constant Power Input
H1/12	RED/WHITE	(-) 200mA Channel 2 Validity Output

## *installation*

---

Be sure to read this section thoroughly and view the Rattler Do-It-Yourself Installation Video in its entirety before starting the installation. Pay special attention to all warnings to prevent personal injury or damage to your vehicle.

Visit our 24-hour technical Web site ([www.diyrattler.com](http://www.diyrattler.com)) to get a vehicle-specific wiring guide prior to starting this installation. If at any time during the installation you are unable to answer your questions on the Web site, call **1-800-873-1314** for live technical assistance.



**warning!** On vehicles with air bags or supplemental restraint systems (SRS) you may notice a bright yellow tube with small wires in it marked SRS underneath the steering column near the key cylinder. **DO NOT** tamper or unplug these for any reason to prevent costly damages to your vehicle or personal injury. Tampering may cause unintended deployment of airbags.



**warning!** **DO NOT** use any testing tool other than a digital multi-meter to prevent costly damages to your vehicle. Use of a test light may cause grounding of sensitive electrical components that can damage the on-board vehicle computer and processors resulting in substantial cost for replacement.



**warning!** Verify that the vehicle is set to park and that the parking brake is set before beginning installation.

→ **step 1**

**Plug-in LED and Valet®/Program switch**

The LED and the Valet®/Program switch both plug into the control module. The status LED plugs into the white two-pin port, while the Valet®/Program switch should be plugged into the blue two-pin port. The status LED and Valet®/Program switch each fit into 9/32-inch holes.

**Status LED**

**Valet® /Program Switch**

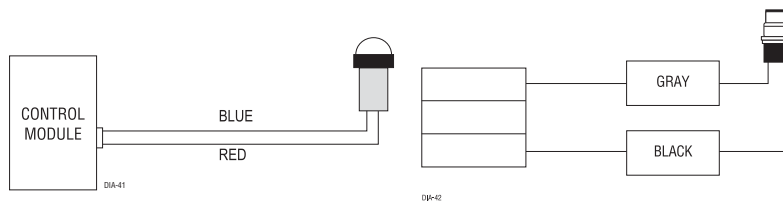

When mounting the LED it will be necessary to locate an area on the dash that is visible from all sides of the vehicle, and has at least 1 inch of clearance behind the mounting area. It is recommended that a factory "pop-out" be used for the LED mounting, using a 9/32 drill bit drill a hole in the location selected, feed the LED through the hole, press the LED firmly until it snaps into place. Run the wires to the selected control module mounting location using caution to NOT run the wires near any moving objects or excessive heat.

The Valet®/Program switch is usually mounted under the dash or in the glove box, the same precautions used for the LED should be followed. Once a location has been selected drill a 9/32 hole,

feed the wires through the hole and press the switch firmly until it snaps into place. Run the wires to the same location as the LED using caution to NOT run the wires near any moving objects or excessive heat.

→ **step 2**

**Ground Wire**

The BLACK wire on the main 8-pin harness is ground. This wire should be connected to a clean, paint-free area of metal in the drivers kick panel area. First strip back a  $\frac{3}{4}$ -inch section of the insulation off the BLACK wire and crimp a ring terminal (not provided) to that wire. Locate a clean, paint-free metal surface in the drivers kick panel. Using a self-tapping screw, drill the screw with the ring terminal to the metal area. Once screwed down, pull on the wire to ensure a good connection.

**note:** More problems are attributed to poor ground connections than any other cause. Take extra care to ensure the ground is clean and secure.

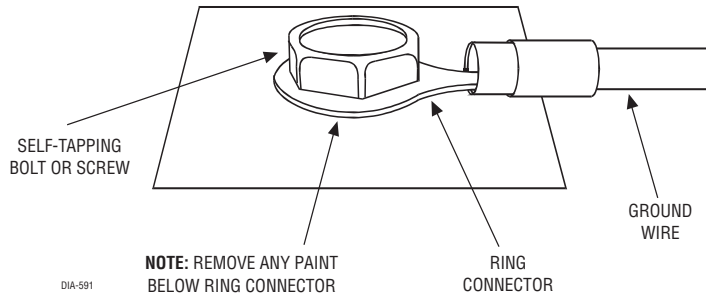

### → step 3

#### Constant Power and Ignition wires

Almost all power and ignition wires can be found behind the key cylinder under the lower drivers side dash panel. Using the appropriate hand tools, remove the lower dash panel using care not to break any parts. If the panel does not come off easily check for any additional screws you may have missed.

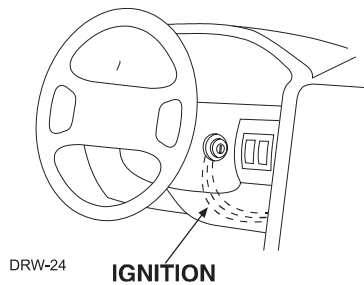

Once the lower dash panel has been removed, locate the ignition harness at the back of the key cylinder. This is usually a group of

thicker wires. With the ignition harness exposed, use your digital multi-meter to find your power and ignition wires.

Place the black lead of the meter to a clean metal surface in the kick panel area and secure it. Put the meter in the DC voltage position, then take the red lead of the meter and probe one of the thicker gauge wires. The color and identity of your specific vehicle wiring can be obtained at [www.diyrattler.com](http://www.diyrattler.com). With the key in the OFF position, test the suspect wire. The constant power wire will read between 11.00 volts and 13.00 volts regardless if the key is on or off.

Once the constant power wire has been identified, solder the RED wire from the 12-pin harness to it and cover the connection with electrical tape to ensure a safe connection.

With the meter black lead still in the kick panel, locate the ignition wire harness in the same location. It will test differently than constant (+)12 volts. Locate the suspected wire using the [www.diyrattler.com](http://www.diyrattler.com) Web site and place the red lead of the meter on the suspected wire. With the key in the off position the meter will read 0.00 volts. Turn the key to the on position and the meter should read between 11.00 volts and 13.00 volts. Now watching the meter, turn the key to the crank position and the voltage should drop a small amount but not disappear. If the voltage disappears this is not an ignition wire but an accessory wire. If the wire meters correctly, solder the YELLOW wire from the 12-pin harness to it and cover the connection with electrical tape.

→ **step 4**

**Starter wire**

The starter wire will be located in the same harness as the ignition and constant power. Leaving the meter black lead connected to the metal ground.

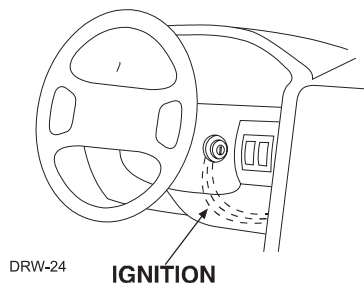

Find the wire suspected to be the starter wire according to the web information on your vehicle. Place the red lead of your meter on the wire. With the key in the off position the meter should read 0.00 volts and will stay at 0.00 volts in all key positions except the crank position. In the crank position your meter should read between 10.00 volts and 13.00 volts, and will drop back to 0.00 volts when the starter disengages. Once you locate the starter wire, cut the wire in half and try to start the vehicle. (Always check the Web site information on your vehicle for warnings regarding the starter wire and check engine lights. Some vehicles will trip a check engine light if the starter wire is cut.) If the vehicle does not start, the correct wire has been identified. Once correctly identified solder the separate ends that you have cut to the heavy gauge black wires on the 2 pin harness and cover the connections with black tape.

Connect the BLACK starter kill wires as shown below. Use one of these wires as the starter kill input and the other as a starter kill output wire (these wires are interchangeable).

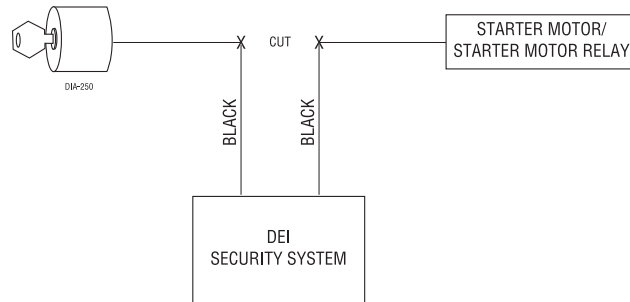

#### → step 5

##### **Parking light flash**

There are several different types of parking light circuits. The following description is for a standard positive-triggered parking light circuit, usually located at the light switch. If the web vehicle information suggests a different type of parking light circuit, please contact Rattler Technical Support.

Using the web information on the vehicle, locate the suspected wire and place the BLACK lead of the meter to a ground and secure it. Place the multi-meter in the DC position. Using the RED lead of the meter, probe the wire. With the switch in the off position the meter will read 0.00 volts. While watching the meter, turn the switch to the parking light position. The meter will read between 10.00 volts and 13.00 volts.



**important:** While reading the meter turn (adjust) the dash dimmer control switch. The voltage should not vary on the meter. If the voltage does vary the incorrect suspected wire has been tested. Find the correct wire and retest.

Once you have identified the correct wire, solder the WHITE wire on the main connector to it and cover the connection with electrical tape.

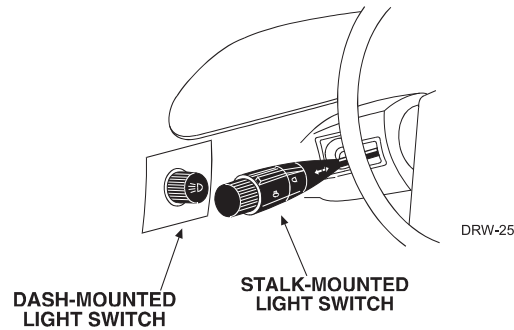

## → step 6

### Door triggers

The door trigger is the circuit in the vehicle that tells the dome light to come on when the door is opened. This wire can be either a positive 12 volt polarity or more commonly a negative ground polarity, the door trigger wire is mandatory for all security systems and can usually be identified on [www.diyrattler.com](http://www.diyrattler.com). Using the information sheet for your specific vehicle locate the suspect wire, if the door trigger listed for your car is a negative type door trigger place the red lead of your meter to a constant 12 volt source and secure it, take the

black lead of the meter and probe the suspect wire with the door open, you will see 11.00 to 13.00 volts appear on the meter, secure the black meter lead to the suspect wire and close the door with the display on the meter visible, if you have the right wire the voltage will drop to 0.00 volts, open the passenger door to verify that the wire sees both doors. Once confirmed solder the GREEN (H1/5) wire on the 12 pin harness to it and cover the connection with black tape.

Some vehicles (mainly FORD) have a positive 12volt door trigger if this is the case in your vehicle place the Black lead of your meter to chassis ground and secure it, place the Red lead of your meter to the suspect wire with the door opened the meter should read 12.00 to 13.00 volts secure the red lead and close the door with the meter display visible, when the door is closed the meter should read 0.00 volts, open the passenger side door and the meter should read 12:00 to 13:00 volts. Once confirmed solder the VIOLET (H1/7) wire to it and cover the connection with electrical tape.

Some newer vehicles have multiple door triggers or a wire for each door, if this is the case it may be necessary to diode isolate the triggers so the security system can see all triggers without the door triggers seeing each other. If your Vehicle has more than one door trigger listed on the vehicle information sheet please refer to the web site or call technical support.

## → step 7

### **Dome light supervision (optional)**

The dome light wire is optional and not required for normal operation, however if desired you can have the security system turn on the dome light when the system is disarmed. If you would like this feature please refer to the web site or call technical support.

## → step 8

### **Siren connection**

The siren should be located under the hood of the vehicle and clear of any moving parts and anything that generates an extreme amount of heat, find a location that will accommodate these requirements and with a couple of self tapping screws mount the siren facing downward. With the siren securely mounted cover the first 12 inches of the siren wire with electrical tape, Locate a rubber grommet that you can gain access to and with a sharp object poke a hole through the grommet, using electrical tape attach the end of the siren wire to the sharp object and poke it back through the existing hole, from the inside of the vehicle pull the remaining slack of the siren wire into the car and remove the sharp object. Route the wire to the desired position making sure to keep it away from all moving parts. Now solder the Red wire of the siren to the BROWN (H1/10) wire on the 12 pin main harness, cover the connection with electrical tape. Ground the Black siren wire to the same location as the BLACK (H1/8) wire of the 12 pin main harness.

→ **step 9**

**Optional connections (channel 2, 3)**

When the system receives the code controlling channel 2, for longer than 1.5 seconds, the RED/WHITE wire (H1/12-channel 2) will supply an output as long as the transmission continues. This is often used to operate a trunk/hatch release or other relay-driven function.

When the system receives the code controlling channel 3, the output is instantaneous, and the WHITE/BLUE wire (H1/3-channel 3) will supply an output as long as the transmission continues. This is used to operate an accessory function.

**important:** Never use these wires to drive anything but a relay or a low-current input! The transistorized output can only supply 200 mA of current. Connecting directly to a solenoid, motor, or other high-current device will cause it to fail.

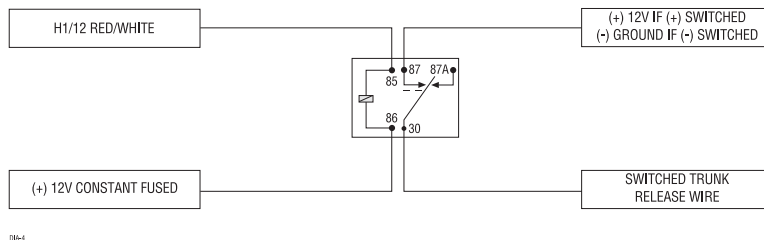

## → step 10

### Hood/trunk pins

The BLUE (H1/6) wire will respond to a negative input with an instant trigger. It is ideal for hood and trunk pins and will report on Zone 1. It can also be used with Directed Electronics 506T Glass Breakage Sensor, as well as other Directed Electronics single stage sensors.

## → step 11

### Adjusting the shock sensor

**note:** The control module must be mounted in its permanent location before adjustments are made.

**important:** Ensure that the adjustment screw on the control module is accessible in the permanent location.



The double guard shock sensor is a two stage sensor; with both warn away trigger and full trigger zones. Adjustment of the sensor will affect both zones simultaneously. To adjust the sensor, turn the adjustment screw on the side of the control module.

- For a more sensitive setting turn the adjustment screw clockwise in small increments, testing the sensitivity after each adjustment until the desired setting is achieved.
- For a less setting turn the adjustment screw counter clockwise in small increments, testing the sensor after each adjustment until the desired setting is achieved.

## → step 12

### Testing the system

With all the previous steps completed, the operation of the system can now be tested.

- Close all the doors and press the  button on the transmitter, the system should chirp one time.
- At this point the system will go through diagnostics, a 15 second process in which the security system will analyze the status of all connected zones.
- After 15 seconds open the driver side door, the alarm should emit a series of chirps to indicate a security breach, after several chirps the system will go into full trigger and the siren will sound.
- At any point during the chirps or full trigger press the  button again and the system should turn off.
- Rearm the system and test the remainder of the doors.
- After testing the doors sit in the vehicle and close the doors, rearm the system and after 15 seconds turn the key on, the system will emit a series of chirps and then go into full trigger, at this time attempt to start the vehicle it should NOT crank.
- Press the  button on the transmitter to disarm the system and cycle the ignition key off, on, off to reset the system.
- Rearm the system, wait 15 seconds and lightly bump the tire with your foot, the system should emit a series of chirps, kick the tire a little harder and the system should go into full trigger.
- Disarm the system.

This completes the testing, if all functions and zones do not

work correctly check your wiring against the manual and verify all connections. If you still are experiencing problems contact Rattler technical support.

**note:** If the shock sensor does not operate as described, see the Shock sensor adjustment section of this guide.

## ***transmitter functions***

---

The receiver uses a computer-based learn routine to learn the transmitter buttons. This makes it possible to assign any specific transmitter button, or combination of buttons, to any receiver function. The transmitter initially comes programmed in the Standard Configuration, but may also be customized. Unless otherwise specified, the buttons used in all of the instructions in this manual correspond to a Standard Configured transmitter.

→ **standard configuration**

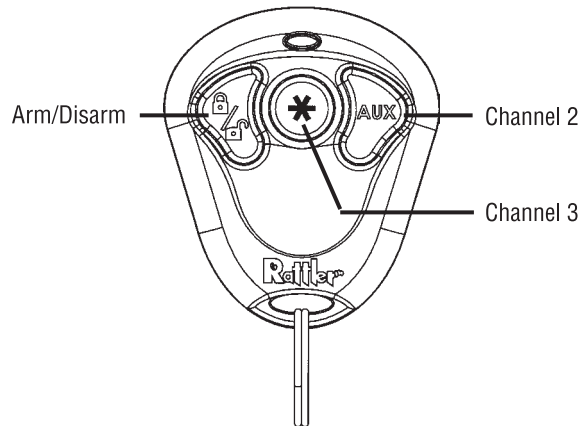

**Button**

The arm/disarm function is controlled by pressing .

**Button** **AUX**

This channel 2 accessory **AUX** is used for trunk release.

**Button**

This channel 3 accessory is an additional channel for optional accessory functions such as remote start.



## *transmitter/receiver learn routine*

---

The system comes with 2 transmitters that have been taught to the receiver. The receiver can store up to 4 different transmitter codes in memory. Use the following learn routine to add transmitters to the system or to change button assignments if desired.

The Valet<sup>®</sup>/Program switch, plugged into the blue port, is used for programming. There is a basic sequence of steps to remember whenever programming this unit: Door, Key, Choose, Transmit and Release.

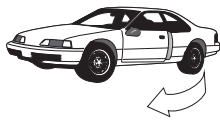

1. **Open a vehicle door.** (The GREEN wire, H1/5, or the VIOLET, H1/7 must be connected.)

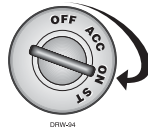

2. **Key.** Turn the ignition to the ON position.



3. **Choose.** Within 10 seconds, press and release the Valet<sup>®</sup>/Program switch the number of times for the desired function. Then press the switch once more and hold it. The siren will chirp and the LED will flash to confirm the selected channel. Do not release the Valet<sup>®</sup>/Program switch.

Channel number	Function
1	Auto Learn
2	Arm/Disarm
3	Channel 2 Output
4	Channel 3/Remote Start
5	Delete all Transmitters



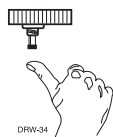

4. **Transmit.** While holding the Valet<sup>®</sup>/Program switch, press the desired button to be programmed on the transmitter.



5. **Release.** Once the button is learned, the siren will chirp, confirming transmitter programming. The Valet<sup>®</sup>/Program switch can now be released.

### Auto Learn function

This function provides a 1-step programming of the transmitter to the following factory default settings:

- Button —Lock/Unlock
- Button —Channel 2 output
- Button —Channel 3/Instant output

**note:** All programmable features will be reset to factory default settings.

### Delete all Transmitters

In case the transmitter(s) is lost or stolen, this function provides removal of all transmitter(s) access from the system memory.

#### Learn Routine will be exited if:

- The doors are closed.
- Ignition is turned off.
- Valet<sup>®</sup>/Program switch is pressed too many times.
- More than 15 seconds elapses between programming steps.

## operating settings learn routine

Many of the operating settings of this unit are programmable. They can be changed whenever necessary through the Operating Settings Learn Routine™. The Valet®/Program push-button switch, plugged into the blue port, is used together with a programmed transmitter to change the settings.

To enter the System Features Learn Routine™:

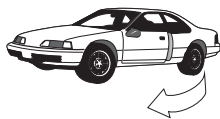

1. **Open a door.** (The GREEN wire, H1/5, or the VIOLET, H1/7 must be connected.)





2. **Ignition.** Turn the ignition on, then back off. (The H1/9 YELLOW switched ignition input must be connected.)



3. **Choose.** Within 10 seconds, press and release the Valet®/Program switch the number of times for the desired function. Then press the switch once more and hold it. The siren will chirp and the LED will flash to confirm the selected channel. Do not release the Valet®/Program switch.



4. **Transmit.** While **HOLDING** the Valet®/Program switch, you can select the desired feature settings using the remote transmitter. Pressing Button  while **HOLD-**

**ING** down the Valet®/Program switch will program the feature to the LED ON settings. The siren will chirp once to indicate the one-chirp setting has been selected. Pressing Button  while **HOLDING** down the Valet®/Program switch will change the setting to the LED OFF setting. The siren will chirp twice indicating that the LED OFF setting has been selected.



5. **Release.** Release the Valet®/Program switch.



### → to access another feature

You can advance from feature to feature by pressing and releasing the Valet®/Program switch the number of times necessary to get from the feature you just programmed to the feature you wish to access. For example, if you just programmed Feature 1 and you want to program Feature 2:

1. Release the Valet®/Program switch.
2. Press and release the Valet®/Program switch **ONCE** to advance from Feature 1 to Feature 2.
3. Press the Valet®/Program switch once more and **HOLD** it.

4. The siren will chirp two times to confirm that you have accessed Feature 2, Confirmation Chirps.

 **to exit the learn routine**

To exit the learn routine, do one of the following:

1. Close the open doors.
2. Turn the ignition on.
3. No activity for longer than 15 seconds.
4. Press the Valet®/Program switch at least 9 times.

## *features menu*

---

The factory defaults are indicated in bold text in the table below.

Feature Number	Default LED On Setting (press transmitter button 1)	LED Off Setting (press transmitter button 2)
1	<b>Active Arming</b>	Passive Arming
2	<b>Confirmation chirps ON</b>	Confirmation chirps OFF
3	<b>No Feature</b>	
4	<b>No Feature</b>	
5	<b>No Feature</b>	
6	<b>No Feature</b>	
7	<b>Code Hopping ON</b>	Code Hopping OFF

**note:** The number in parentheses indicate the number of times the LED will flash. The Factory defaults are indicated in **bold** type.

## *feature descriptions*

---

- 1 **ACTIVE/PASSIVE ARMING:** When active arming is selected, the system will only arm when the transmitter is used. When set to passive, the system will arm automatically 30 seconds after the last door is closed. Passive arming is indicated by the rapid flashing of the LED when the last protected entry point is closed.
- 2 **CONFIRMATION CHIRPS ON/OFF:** This feature controls the chirps that confirm the arming and disarming of the system.
- 3 **NO FEATURE**
- 4 **NO FEATURE**
- 5 **NO FEATURE**
- 6 **NO FEATURE**
- 7 **CODE HOPPING™ ON/OFF:** This system features Code Hopping™ as an option. Code Hopping™ is a feature that uses a mathematical formula to change the system's code each time the transmitter and receiver communicate. This makes the group of bits or "word" from the transmitter very long. The longer the word is, the easier it is to block its transmission to the unit. Disabling the Code Hopping™ feature lets the receiver ignore the Code Hopping™ part of the transmitted word. As a result, the unit may have better range with Code Hopping™ off.



## *using your system*

---

### → **arming with transmitter**

Pressing  for one second will arm the system. The parking lights will flash once and the siren will chirp once to confirm that the system is armed.

### → **arming without a transmitter**

The security system also can be programmed to arm itself without a transmitter (called passive arming). If the system is programmed for passive arming, it will automatically arm 30 seconds after the ignition is turned off and the system sees you leave the vehicle by opening and closing a door. After the last protected entry is closed the LED rapidly flashes for 30-seconds and the parking light flash and the siren chirps. The system arms at 30 seconds, but the siren will not chirp.

**note:** If any protected entry point (a door or a switch-protected trunk or hood) is open, the system will not passively arm. Additionally, each time a protected entry is triggered during the arming countdown, the 30-second countdown starts over.

When armed, your vehicle is protected as follows:

- The LED will flash as a visible theft deterrent.
- Light impacts will trigger the Warning Zone signal. When triggered, the siren will sound for a few seconds.

- Heavy impacts will trigger the system. The triggered sequence is 30-seconds of constant siren sounding and flashing parking lights.
- If a protected entry (door, hood, or trunk) is opened, the system will immediately trigger the siren and flash the parking lights. The hood and trunk are instant alarm triggers. The door is a progressive trigger (a series of rapid chirps for a few seconds before the alarm sounds). The progressive trigger allows time for you to disarm of the system prior to the alarm.

 **disarming with transmitter**

To disarm the system press  for one second. The parking lights will flash twice and the siren will chirp twice to confirm that the system is disarmed.

## → **disarming without a transmitter**

If your remote transmitter is lost or damaged, you can manually disarm your vehicle security system. To disarm the system without a transmitter, you must have the vehicle's ignition key and know where the Valet®/Program switch is located. Be sure to check with your installer at the time of installation for its location.



### **To disarm the security system:**

1. Turn the ignition key on.

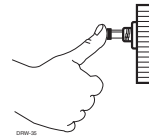

2. Press the Valet®/Program switch within 15 seconds. The system will now disarm.

**note:** If the system does not disarm, you may have waited too long to press the Valet®/Program switch; turn the ignition off and repeat the process.

## → **panic mode**

If you are threatened in or near your vehicle, you can press  for 1.5 seconds to trigger Panic Mode on your security system and attract attention. The siren will sound and the parking lights

will flash for 30-seconds. To stop the Panic Mode at any time, press  again.

### → **silent mode**

Use the Silent Mode to temporarily turn off the arm or disarm chirps by briefly pressing **AUX** before pressing the  when arming or disarming. The confirmation chirp(s) will then be eliminated for that one operation only. To permanently turn off the arm and disarm chirps, see the programming section of this guide.

**note:** The Warn Away Response to lighter impacts is bypassed if the system is armed using the Silent Mode. This ensures that the siren does not chirp in an environment where you do not want chirps to be emitted. The system is still capable of being triggered by heavier impacts; only the Warn Away Response generated by light impacts is bypassed.

### → **valet mode**

Valet Mode prevents your security system from passive arming. All transmitter convenience functions (door locks, trunk release, etc.) remain operational. This feature is useful when washing or servicing your vehicle. You can access Valet Mode either manually or from the remote transmitter.

## → manual valet mode

To enter or exit Valet Mode with the Valet®/Program switch:



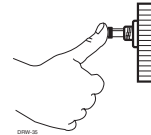

1. Turn the ignition on.
2. Turn the ignition off.
3. Press and release the Valet®/Program switch within 10 seconds.



The status LED will light steady if you are entering Valet Mode and will turn off if you are exiting Valet Mode.

## → remote valet

You can also enter or exit Valet Mode by using the remote transmitter:

1. Open any vehicle door.
2. Press .
3. Press **AUX**.
4. Press  again.

The status LED will light steady if you have entered Valet Mode and will turn off if you have exited Valet Mode.

**note:** In Valet Mode the LED will turn off if the ignition is turned ON. The LED will turn back on if the ignition is turned OFF. This notifies you that the system is still in Valet Mode.

## *diagnostics*

---

The microprocessor at the heart of your system has the ability to constantly monitor all of the switches and sensors connected to it. It can detect any faulty switches or sensors and prevent them from disabling the entire system. It can also record and report any triggers that occur when you are away from your vehicle.

### → **arming diagnostics**

If the system is armed at the same time that an input is active (door opening, sensor triggering, etc.), you will hear one chirp to indicate arming and a second chirp a few seconds later to indicate Bypass Notification.

A Bypass Notification chirp means that the system ignores the input that was active when the system was armed, until that input ceases. Three seconds after that input ceases, the system will resume normal monitoring.

For example, if your vehicle has an interior light exit delay and you arm the system before the light turns off, you may hear a Bypass Notification chirp. Three seconds after the light turns off, however, normal monitoring resumes.

**note:** Bypass Notification does not occur when the system is in Silent Mode™ or if the chirps have been programmed not to sound.

### **→ disarming diagnostics**

Your system has a Tamper Alert feature that notifies you of system triggers that occur while you are away from your vehicle.

If you hear four chirps when you disarm, this indicates that the system was triggered in your absence.

If you hear five chirps when you disarm, this indicates that a specific zone was triggered so many times that the NPC™ has bypassed that zone.

In both cases, the pattern of the flashing status LED indicates which zone was triggered (see Table of Zones).

The LED does not, however, report when Warn Away Responses have activated; it only reports Triggered Sequences. The system retains this information in its memory and will continue to chirp four or five times each time the system is disarmed, until the next time the ignition is turned on.

→ **system status chirps**

<b>ACTION</b>	<b>NUMBER OF CHIPS</b>	<b>DESCRIPTION</b>
<b>Arm</b>	1	System armed
<b>Arm</b>	1 (3-second delay), 1	System armed with Bypass Notification
<b>Disarm</b>	2	System disarmed
<b>Disarm</b>	4	System disarmed with Tamper Alert
<b>Disarm</b>	5	System disarmed NPC® active



## → table of zones

A zone is represented by the number of LED flashes used by the system to identify a particular type of input. Standard input assignments are listed in the following table, along with spaces to write in any optional sensors or switches that you have had installed.

<b>ZONE</b> (Number of LED Flashes)	<b>DESCRIPTION</b>	<b>DEALER-INSTALLED OPTIONS</b>
<b>1</b>	Instant trigger for optional hood or trunk pins	
<b>2</b>	A heavier impact detected by the Shock Sensor	
<b>3</b>	Door switch trigger	
<b>5</b>	Ignition trigger	

**note:** The LED does not report when the Warn Away® response has been activated; it only reports Triggered Sequences.

## → nuisance prevention circuitry

Your security system has Nuisance Prevention Circuitry™ (NPC™) to prevent annoying false alarms. This prevents repetitive trigger sequences due to faulty door pinswitches or environmental conditions such as thunder, jackhammers, airport noise, etc.

Here's how it works: If the alarm is triggered by the same sensor or switch three times within a 60 minute period, your system

interprets this pattern of triggers as false alarms. After the third trigger, the NPC™ ignores, or bypasses, that sensor or switch (along with any other sensors or switches sharing the same zone) for 60 minutes. If the bypassed sensor is triggered again while it is already being bypassed, the 60-minute bypass period will start over. This ensures that a sensor that is continually being triggered will remain bypassed.

The vehicle doors are protected differently by NPC™. If your security system is triggered by an open door for three, full 30-second cycles (one and one half minutes), the system will bypass the doors until the trigger ceases.

note: Arming and disarming the system does not reset the NPC™. The only ways to reset a bypassed zone are for that zone not to be triggered for 60 minutes or to turn the ignition key on. When testing your system, it is important to remember that NPC™ can cause zones to be bypassed and appear to not work. If five chirps are heard when disarming the system, NPC™ has been engaged. To clear the NPC™ memory, simply turn the ignition key on.

## *code hopping™ re-synchronize*

---

If the transmitter is pressed many times out of range, or the battery is removed, the transmitter may get temporarily out of synchronization and fail to operate the system. To synchronize the transmitter, simply press  several times within range of the vehicle. The system will automatically synchronize and the transmitter will respond normally.

## *troubleshooting*

---

- **Door input does not immediately trigger full alarm. Instead, first I hear chirps for 3 seconds:**

That's how the progressive two-stage door input works! This is a feature of this system. This is an instant trigger, remember, since even if the door is instantly re-closed, the progression from chirps to constant siren will continue.

- **Closing the door triggers the system, but opening the door does not:**

Have you correctly identified the type of door switch system? This often happens when the wrong door input has been used. (See *H1/5 GREEN Door Trigger Input, Primary Harness Wire Connection Guide* section of this guide.)

- **System will not passively arm until it is remotely armed and then disarmed:**

Are the door inputs connected? Is the H1/6 blue wire connected to the door trigger wire in the vehicle? Either the H1/5 green or the H1/7 violet should be used instead. (See *Primary Harness Wire Connection Guide* section of this guide.)

➤ **Door input does not respond with the progressive trigger, but with immediate full alarm:**

Does the Status LED indicate that the trigger was caused by the shock sensor? (See *Table of Zones* section of this guide.) The shock sensor, if set to extreme sensitivity, may be detecting the door unlatching before the door switch sends its signal. Reducing the sensitivity can solve this problem.

➤ **The Valet®/Program switch doesn't work.**

Is it plugged into the correct socket? (See *Plug-In LED and Valet®/Program/Program Switch* section of this guide.)

➤ **Status LED doesn't work.**

Is the LED plugged into the correct socket? (See *Plug-In LED and Valet®/Program Switch* section of this guide.)

## ***glossary of terms***

---

**Control Module:** The "brain" of your security system. Usually hidden underneath the dash area of the vehicle. It houses the microprocessor that monitors your vehicle and controls all of the security system's functions.

**Failsafe® Starter Kill Relay:** Located on-board the control module, this is an automatic switch controlled by the security system that prevents the vehicle's starter from cranking whenever the system is armed. The vehicle is never prevented from cranking when the system is disarmed, in Valet Mode, or if the starter kill fails.

**Input:** Any physical connection to the security system. An input can be provided through a sensor, pinswitch or by existing systems in the vehicle, such as ignition or courtesy lights.

**LED:** A red light mounted inside the vehicle, at a location determined by the installer. The LED indicates the status of your system and also reports triggers and faults in the system or sensors.

**Shock Sensor:** A dual-stage shock sensor, located on-board the control module, that detects impacts to the vehicle.

**Siren:** A noise generating device, usually installed in the engine compartment of the vehicle. The siren generates the chirps and tones heard when the system is triggered.

**Transmitter:** A hand-held, remote control that operates the various functions of the security system.

**Trigger or Triggered Sequence:** The "setting off" or "tripping" of the alarm. A Triggered Sequence consists of the siren sounding and the parking lights flashing for 30 seconds.

**Valet®/Program Switch:** A small, push-button switch mounted inside the vehicle, at a location determined by the installer. This switch is used to override the alarm when a transmitter is lost or damaged, or can be used to put the system into Valet Mode.

**Warn Away Response:** Light impacts to the vehicle generate the Warn Away Response, which consists of several seconds of siren chirps and flashing parking lights.

**Zone:** A zone is a separate input that the alarm recognizes as unique. Each input to the system is connected to a particular zone. Two or more inputs may share the same zone.

## *security & convenience expansions*

Listed below are some of the many expansion options available for use with your system. Some options may require additional parts and/or labor. Please consult with your dealer for a complete list of options available for use with this system.

**Audio Sensor:** Metal on glass, glass cracking, and breaking glass produce distinctive acoustic signatures. The 506T audio sensor uses a microphone to detect these sounds, and then analyzes them with proprietary acoustic software to determine if the glass has been tampered with or broken.

**Backup Battery:** The 520T Backup Battery ensures that the system stays armed, triggers the alarm and keeps the optional starter kill active if main battery power is disconnected.

**Field Disturbance Sensor:** An invisible dome of coverage is established by the 508D "radar" sensor. Your security system will respond to any intrusions into this field by initiating the triggered sequence.

**Power Trunk Release:** The **AUX** output of the system can operate a factory power release for the vehicle's trunk or hatch. An optional relay is required. If the factory release is not power-activated, then Directed Electronics' 522T trunk release solenoid can be added in most cases.

**Power Window Control:** Automatic power window control is provided with the 529T and 530T systems. These options operate power windows, by rolling them up, down, or both up and down. The 530T also offers one-touch switch operation.

**Valet™ Start System:** For the ultimate in convenience, the Valet Start System can start your vehicle, monitor engine functions and activate your climate control system with a push of a button! Over-rev protection, open-hood lockout, brake pedal shutoff and automatic timer shutoff are included. (This option is available only for fuel-injected, automatic-transmission vehicles.)



# wiring quick reference diagram

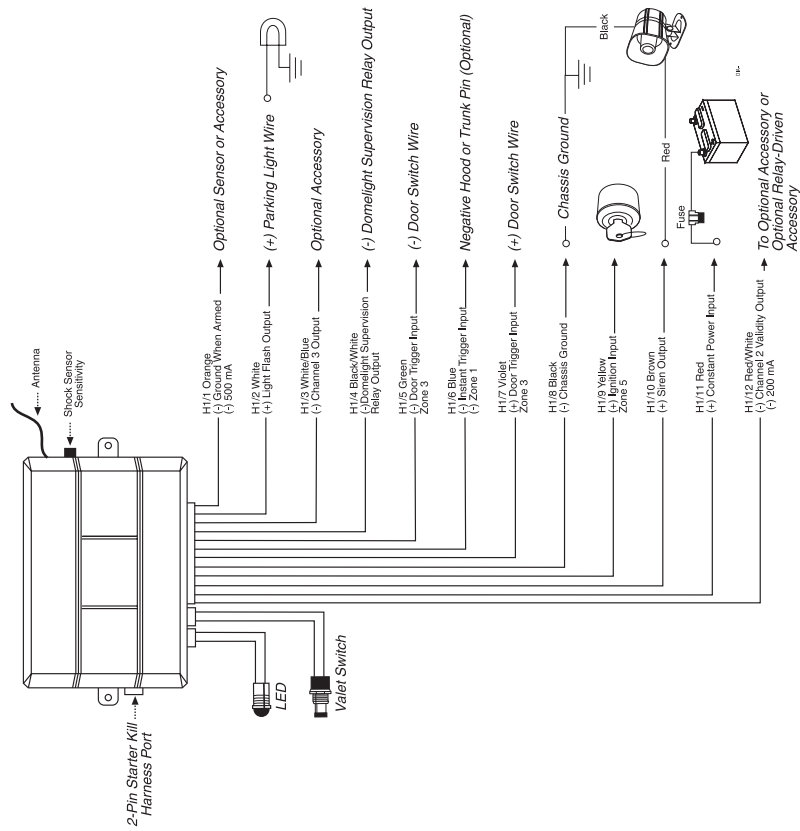







Cut along dotted line and fold for a quick and easy reference to keep in your purse or wallet.

## QUICK REFERENCE GUIDE:

### To arm the system using your remote

- Pressing  for one second will arm the system. The parking lights will flash once and the siren will chirp once.

### To disarm the system using your remote

- To disarm the system, press  for one second. The parking lights will flash twice and the siren will chirp twice to confirm the system is disarmed.

### To enter panic mode using your remote

- Press  for 1.5 seconds. The parking lights will flash and the siren will sound for 30 seconds.

## QUICK REFERENCE GUIDE:

### To arm the system using your remote

- Pressing  for one second will arm the system. The parking lights will flash once to confirm the doors are locked.

### To disarm the system using your remote

- To disarm the system, press  for one second. The parking lights will flash twice to confirm the system is disarmed.

### To enter panic mode using your remote

- Press  for 1.5 seconds. The parking lights will flash and the siren will sound for 30 seconds.





The company behind this system is Directed Electronics, Inc.

Since its inception, Directed Electronics has had one purpose, to provide consumers with the finest vehicle security and car stereo products and accessories available. The recipient of nearly 100 patents and Innovations Awards in the field of advanced electronic technology, DIRECTED is ISO 9001 registered.

Quality Directed Electronics products are sold and serviced throughout North America and around the world.

Call **(800) 274-0200** for more information about our products and services.



DEI is an ISO 9001 registered company.

Directed Electronics is committed to delivering world class quality products and services that excite and delight our customers.



Directed Electronics, Inc.

Vista, CA 92081

[www.directed.com](http://www.directed.com)

© 2003 Directed Electronics, Inc. - All rights reserved

G322R 7-03