



CS-2011RS Series IV

Super Rage™

Remote Control Alarm & Remote Engine Starting System

OPERATION INSTRUCTIONS

INTRODUCTION

CONGRATULATIONS on your choice of a Super Rage™ Alarm & Remote Engine Starter by Crimestopper Security Products Inc. This booklet contains the information necessary for operating your system. If any questions arise, contact your installation dealer or Crimestopper Security Products Inc.

***IMPORTANT INFORMATION: Primary and Optional Features**

-PRIMARY: These are features that must be connected in order for the system to operate properly i.e. Power, Ground, Lights, Siren, etc.

-OPTIONAL: Optional features are connected only if desired or agreed upon by the installing dealer i.e. Door Locks, Horn Honk, Dome light illumination, Starter Kill, L.E.D., Trunk Pop, etc. These features may require additional parts and labor charges. Consult with your installer about these features **before** installation.

CONTACT INFORMATION:

TECHNICAL SUPPORT (800)-998-6880
Monday - Friday 8:00am - 4:30pm Pacific

Website: www.crimestopper.com
E-mail: tech-support@crimestopper.com

CRIMESTOPPER
SECURITY PRODUCTS, INC.
1770 S. TAPO STREET
SIMI VALLEY, CA. 93063

This device complies with FCC Rules part 15. Operation is subject to the following two conditions: 1) This device may not cause interference, and (2) this device must accept any interference that may be received, including interference that may cause undesired operation. The manufacturer is not responsible for any radio or TV interference caused by unauthorized modification to this equipment. Such modification could void the user's authority to operate the equipment.

TABLE OF CONTENTS

Operation Cautions & Warnings.....	2
Operating Instructions - Alarm.....	3-6
LED Diagnostics.....	6
Remote Engine Control.....	6-10
Optional Turbo Timer Mode.....	11
Anti-Carjack Protection.....	12
Transmitter Programming.....	13
2 Vehicle Operation.....	14
Troubleshooting: “Before you call section”.....	15

OPERATION CAUTIONS & WARNINGS

CRIMESTOPPER SECURITY PRODUCTS, INC. and its **VENDORS** shall not be liable for any accident resulting from the use of this equipment. This system is designed to be professionally installed into a car or vehicle in good running order. Items, such as parking brake, door switches, and all engine safety features, must be in perfect working condition.

DAMAGE resulting from misuse or negligence is **NOT** covered under warranty and will be subject to repair and / or replacement charges.

IT IS ABSOLUTELY THE OWNER’S SOLE RESPONSIBILITY TO: A) Understand the operation of this system and its safety features. B) Check for proper operation of these safety features prior to accepting delivery of the vehicle from the installation facility. C) Check and maintain the condition of the vehicle and all items relative to the proper operation of this system and its safety features.

DO NOT remote start the vehicle in a closed garage. Make sure that the vehicle is outdoors, a garage door is open, or there is adequate exhaust ventilation. Failure to observe this rule could result in **injury or death** from poisonous Carbon Monoxide fumes. This is especially important when using the Timed Self-Start feature of the unit

OPERATING INSTRUCTIONS - ALARM

Active Arming / Locking:

Press and release button #1 (Lock symbol) on the transmitter. The System will arm and confirm with one siren chirp, one light flash, and the LED will begin to flash. Power locks will lock (if equipped). Starter disable circuit will turn on. After a short delay to allow the vehicle and electronics to settle, the system will be completely armed.

Disarming: / Unlocking

Press and release button #2 (Unlock symbol) on the transmitter. System will disarm and confirm with two siren chirps, two light flashes, and the LED will turn off. Power locks will Unlock and Interior Dome light will turn on (if installed with these optional features)

Disarming While Tripped (Triggered):

Disarming the System while it is triggering requires TWO presses of the #2 Unlock Button. The first press of Button #2 Resets the alarm cycle only (system still armed) while a second press will disarm/unlock the system.

Silent Arming/Disarming (On demand):

To Arm or Disarm the system without siren chirps, press and release both Buttons #2 (Unlock) and #4 (Start) at the same time. System will Arm or Disarm without siren chirps that one time. Flashing lights and LED will be the only indicators of Arm/Disarm status. If the system was tripped while you were away, 4 chirps will be heard to notify you that the system was tripped.

Silent Arming/Disarming (Chirp Defeat):

This system can be programmed to silent arm and disarm using the normal lock and unlock buttons. Flashing lights and LED will be the only indicators of armed or disarm status. Check with your installer or follow programming option instructions in the installation manual.

Alarm Triggering

An intrusion into the vehicle or hard impact to the body will sound the alarm and flash the lights for 1 minute. After 1 minute the trigger cycle will automatically stop and alarm will remain armed to continue protecting the vehicle. If a door is left open after an intrusion then the unit will cycle a maximum of 5 minutes and continue to protect the other un-tampered or unopened zones.

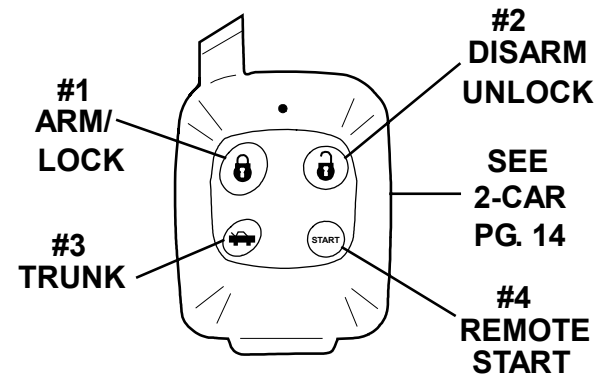

CS-2011RS TRANSMITTER BUTTONS

OPERATING INSTRUCTIONS - ALARM

Prior intrusion Alert

This system will notify you if the alarm was tripped while you were away. Upon disarming, the two normal disarm chirps will be heard then the system will emit 4 additional siren chirps. Check your vehicle for any signs of a break in or tampering. Also see LED Diagnostics Section to determine the cause of the trigger.

Remote Panic Protection

To sound the alarm in an emergency situation or to draw attention to your vehicle, press and hold Button #1 (Lock) for at least 3 seconds until the siren sounds. Press Button #2 (Unlock) to reset panic mode.

Arming With Shock Sensor Bypass

To arm the alarm and bypass shock sensor protection, press Button #1 as normal then press and release Button #1 and #2 together within 2 seconds. You will hear 3 extra siren chirps indicating shock sensor bypass for this arming cycle only.

Open Zone Alert / Bypass

Upon arming, this system will warn you if a door is left open. After a 60 second setup delay (for extended dome lights) has elapsed, if the system detects a fault or a door left open, the siren will chirp 5 times along with 5 light flashes. This zone will be automatically bypassed and the alarm will protect all other zones.

Pre-Warning Shock Protection

The Pre-warning (warn-away) feature will activate when a low-level shock or vibration detected by the system's shock sensor. The alarm will chirp the siren 5 times and flash the lights once to help deter any further tampering with the vehicle.

Passive Arming Mode: (Programmable)

Passive (automatic) arming occurs 30 seconds after the ignition is turned off and the last door is closed. Upon closing the last door, the unit will flash the lights twice and LED will be flashing rapidly to confirm passive countdown. If a door is reopened within the 30 second period, the countdown stops and begins again when the door is closed. Passive arming provides failsafe protection in case you forget to arm the system.

Passive Locking: (Programmable)

The CS2011RS system can be programmed to passively lock the doors when the system passively arms. The default setting is OFF because passive locking increases the risk of locking the keys in the vehicle.

Trunk/Hatch Pop (Optional, Remote AUX. Output 1)

This feature is designed to interface with existing Factory power trunk or power hatch release systems and may require additional parts and/or labor charges. Press and release Button #3 (Trunk) on the transmitter to
4 pop/open the trunk/hatch. If the system is armed, it will also disarm when the button #3 is pressed.

OPERATING INSTRUCTIONS - ALARM

Remote AUX. Output 2 (Optional)

This system contains a second auxiliary output to activate other accessories or devices. To activate the systems' Second Auxiliary Output, press and hold Button #3 (Trunk Symbol) on the transmitter for more than 2 seconds. This is a momentary output that will stay active as long as the remote button is held down. Remote output #2 requires programming before operation. Check with your installer or follow programming option instructions in the installation manual.

Dome Light Illumination (Optional)

This feature will turn on the vehicle's dome light upon disarming for 30 seconds or until the key is inserted and turned on. This will provide illuminated entry to your vehicle in dimly lit areas for safety and security.

Emergency Override (Disarm)

If you have lost the transmitter or it stops working for any reason and the Alarm is armed, you will have to disarm the system manually. Open the door with the key [alarm will sound], turn the ignition on, and press the override/program button for about 5 seconds. The Alarm will disarm and allow you to use the vehicle until you can repair/replace the remote. Note that you may need to put the system into valet mode to prevent passive arming.

Valet Mode (Enter manually or using the remote)

To disable Alarm and Remote Engine Starting for vehicle servicing or otherwise, turn the ignition on and press the override/program button [about 5-7 seconds] until you hear (3) siren chirps and the LED turns on solid. Repeat the process to exit VALET mode. To enter / exit valet via the remote, press and hold both buttons #1 (Lock) and Button #2 (unlock) together for about 3 seconds until 3 chirps are heard. Repeat this step to exit via the remote transmitter. Lock/Unlock and AUX features will still operate in when in VALET mode however remote start and alarm functions are inhibited.

Valet Park Mode (Using the remote transmitter only)

Note: Valet Park mode is only accessible when using the remote transmitter. Valet park mode allows you to turn over the vehicle to a valet allowing access to drive/lock/unlock your vehicle, but alarm will trigger if the trunk is opened. To activate Valet Park, press and hold both buttons #1 (Lock) and Button #2 (unlock) together for about 6 seconds. 3 chirps will be heard first when unit goes into regular Valet and as you continue to hold both buttons you will hear 2 more chirps. LED will flash slowly when in Valet Park. Repeat step to exit Valet Park mode.

OPERATING INSTRUCTIONS - ALARM

Optional M.A.P. (Mobile Accessories Protection)

This system can be programmed to provide Crimestopper's unique M.A.P. (Mobile Accessories Protection) feature that allows you to prevent unauthorized access of your vehicles Audio, Cellular, Navigation, or Entertainment systems. This feature is OPTIONAL and will require extra parts and labor for installation. Consult your installation dealer about MAP before or during installation. The CS2011RS must be programmed for MAP operation. When the system is put into Valet Park mode, M.A.P. will prevent stereo, entertainment, navigation, or cellular system from being used.

LED DIAGNOSTICS

The CS-2011RS system includes disarm diagnostics, through the RED LED light, that will help in determining what caused the last trigger of the alarm system. This is a valuable tool in determining how the vehicle was tampered with or if there is a false alarm problem in which case you can make the necessary adjustments to correct the problem. When the system is disarmed with the remote you will hear the normal 2 chirps, then 4 quick chirps that indicate the alarm was triggered while you were away. Check the LED light for a sequence of flashes:

Shock Sensor = 1 Flash

Door = 2 Flashes

Hood/Trunk = 3 Flashes

Ignition = 4 Flashes

Diagnostics will reset when the Ignition is turned on or when the system is re-armed.

REMOTE ENGINE CONTROL

REMOTE ENGINE STARTING - SUCCESSFUL START

- 1) Press and release the remote start button on the remote transmitter. System will chirp 3 times for audible confirmation. (Chirps can be programmed on or off-See Option programming in the installation manual.)
- 2) Parking lights flash once, then turn on solid, Ignition/Accessory circuits turn on.
- 3) After 6 seconds Starter Motor engages, Parking lights and Accessory circuits turn off while cranking.
- 4) Engine Starts and Runs. Parking Lights and Accessory turn back on, Doors Lock.
- 5) Engine will remain running for programmed run time until reset with Brake pedal. If needed, the engine can be turned off with remote transmitter.

REMOTE ENGINE CONTROL

REMOTE ENGINE STARTING - SUCCESSFUL START DIAGRAM:

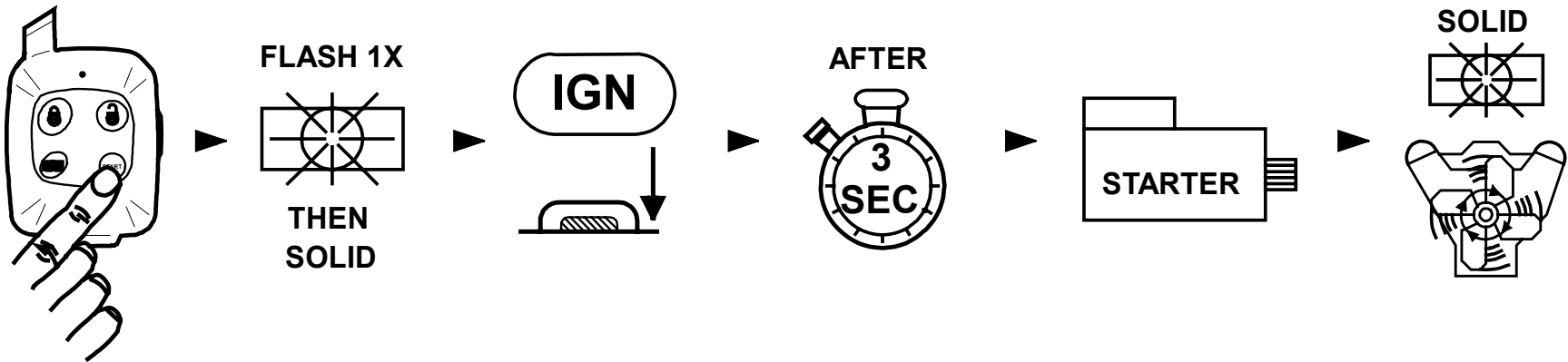

REMOTE ENGINE STARTING - UNSUCCESSFUL START

In the event that the engine does not start on the first attempt, the system shuts down for a few seconds, then attempts to restart the engine a 2nd and 3rd time. For hard starting engines, the unit will allow a starter crank time of up to 13 seconds maximum. This should provide ample cranking time for difficult starts, but is limited to 13 seconds to help prevent damage to the starter from over cranking.

- 1) If engine starts on 2nd or 3rd attempt, see steps 4 & 5 above of "Successful Start".
- 2) If Third attempt fails to start engine, the system will turn off and doors will remain locked. *NO FURTHER ATTEMPTS WILL BE MADE AUTOMATICALLY UNLESS YOU PRESS THE START BUTTON AGAIN.*

TURNING OFF A REMOTE STARTED ENGINE:

- 1) Engine is running in Remote Start (Parking lights ON).
- 2) Press and release the Start button.
- 3) Engine & parking lights turn OFF, Doors remain locked or will re-lock if applicable.

TURNING OFF A REMOTE STARTED ENGINE DIAGRAM:

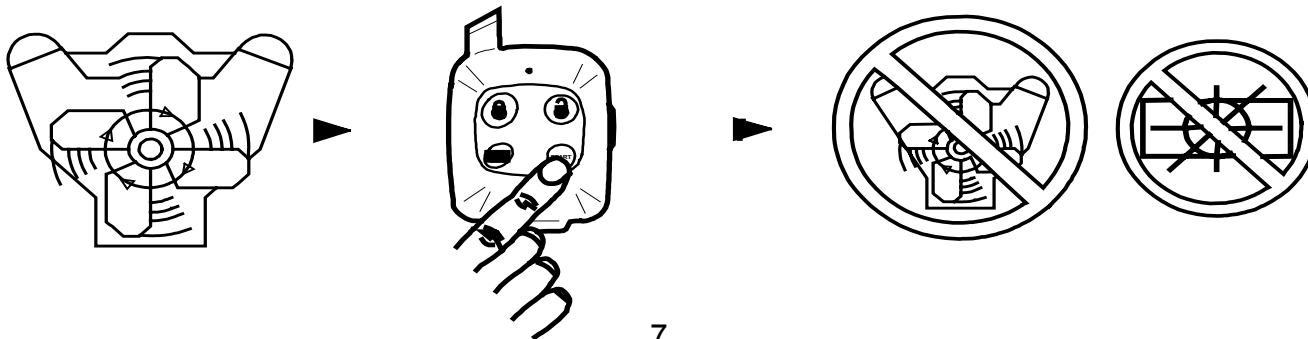

REMOTE ENGINE CONTROL

ENTERING YOUR REMOTE STARTED VEHICLE:

- 1) With engine running, Remote Unlock/Disarm system (If armed) or open door with key.
- 2) Enter vehicle and be careful not to step on brake pedal! (Remote Start Reset)
- 3) Turn Ignition to ON/RUN position, then press brake pedal to reset the Remote Starter & Shift out of park.
- 4) Remote starter will reset instantly when the brake is pressed. Parking lights will turn off and the ignition key is now controlling your vehicle.

IDLE DOWN MODE (TAKE-OVER OPERATION)

This mode allows the unit to take over operation of your idling, parked vehicle while the ignition key is removed and you exit the vehicle. The vehicle is put into a remote running condition before you exit and it will remain running for the programmed run time, until you return, or until the remote start button is pressed.

Examples:

You pull up to a convenience store for a quick stop, "Idle Down" mode keeps engine running when you exit the vehicle, (with keys in hand) remote lock/arm alarm. When you return, unlock/disarm alarm, turn ignition ON and drive away. This mode can also be used on Turbo vehicles that need idle for cool-down.

IDLE DOWN MODE - EXITING THE VEHICLE:

- 1) With engine running, press and release the Start button. Siren will chirp 3 times for confirmation.
- 2) Parking Lights will turn ON.
- 3) Doors will unlock, or if brake pedal is being depressed doors will unlock when it is released.
- 4) Turn OFF Ignition and remove key. Engine should remain running.
- 5) Exit vehicle then remote lock doors if desired.
- 6) Engine will remain running for programmed run time, until you return, or press the remote start button.

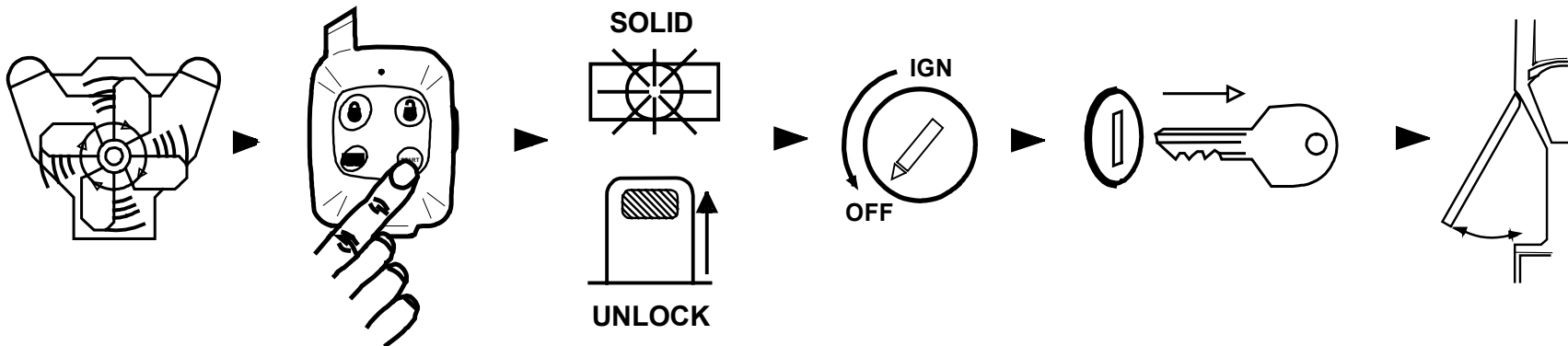

ENTERING A VEHICLE DURING "IDLE-DOWN" or "INFINITY RUN" MODES:

See "ENTERING YOUR REMOTE STARTED VEHICLE" section above.

REMOTE ENGINE CONTROL

INFINITY RUN MODE

This mode allows the vehicle's engine to remain running *INDEFINITELY*. This mode can be beneficial to law enforcement vehicles or commercial vehicles that need to remain running unattended for long periods of time.

INFINITY RUN MODE – EXITING THE VEHICLE:

- 1) Follow steps on the last page for “IDLE DOWN MODE - EXITING THE VEHICLE”, except press the remote start button **TWO** times at STEP #1.
- 2) Parking Lights will start flashing instead of coming on solid, and doors will unlock.
- 3) Turn Ignition switch OFF, remove key and exit the vehicle. Engine should remain running.
- 4) The vehicle's parking lights will flash for the programmed run time of 12, 24, or 36, or 48 minutes and then switch to solid while motor runs indefinitely or until fuel supply runs out.

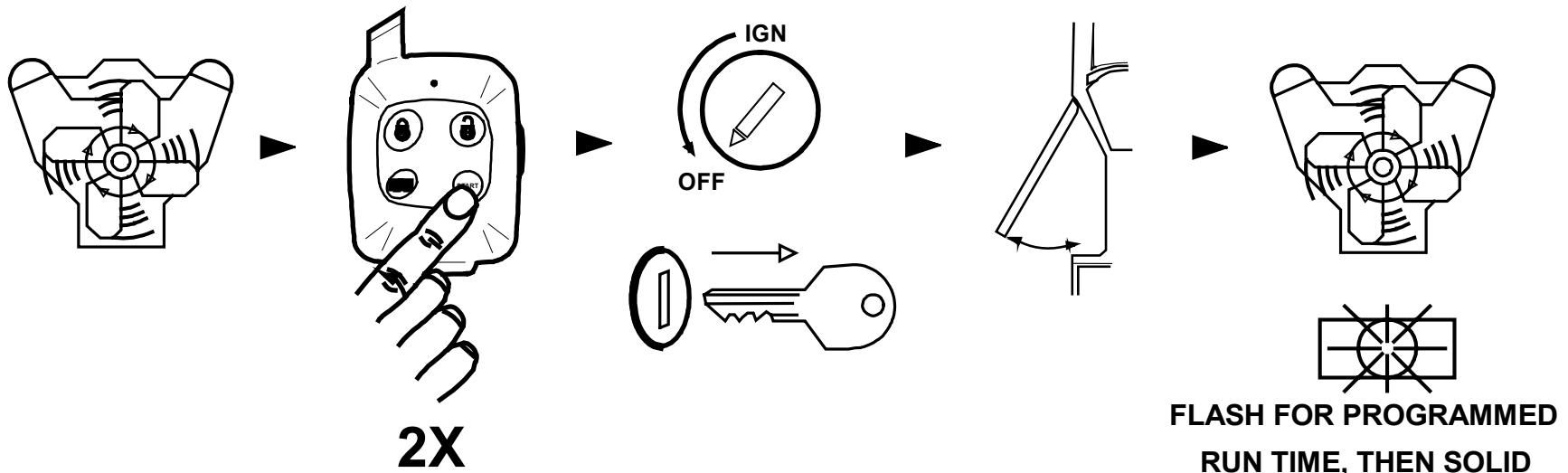

ENTERING A VEHICLE DURING “IDLE-DOWN” or “INFINITY RUN” MODES:

See “ENTERING YOUR REMOTE STARTED VEHICLE” section at top of page 8.

REMOTE ENGINE CONTROL

TIMED SELF START MODE

This mode allows the vehicle to be programmed to self-start every 4 hours and run for the programmed run time. This can be helpful during extremely cold conditions where engine fluid freeze-up is a concern. THE VEHICLE MUST BE OUTDOORS OR IN A WELL VENILATED AREA.

TIMED SELF-START MODE – EXITING THE VEHICLE:

- 1) Have engine running with the Key, then press and release the Start button.
- 2) Within the next 10 seconds press the valet/program button once.
- 3) Parking Lights will turn OFF for about 5 seconds, and doors will unlock.
- 4) Turn Ignition switch OFF, remove key and exit the vehicle. Engine should remain running.
- 5) To turn off the engine, press the remote start button. The parking lights will flash 4 TIMES as a confirmation that the unit is in Timed Self-Start Mode.
- 6) The Vehicle will Start by itself every 4 hours until driven with key or started via remote control.

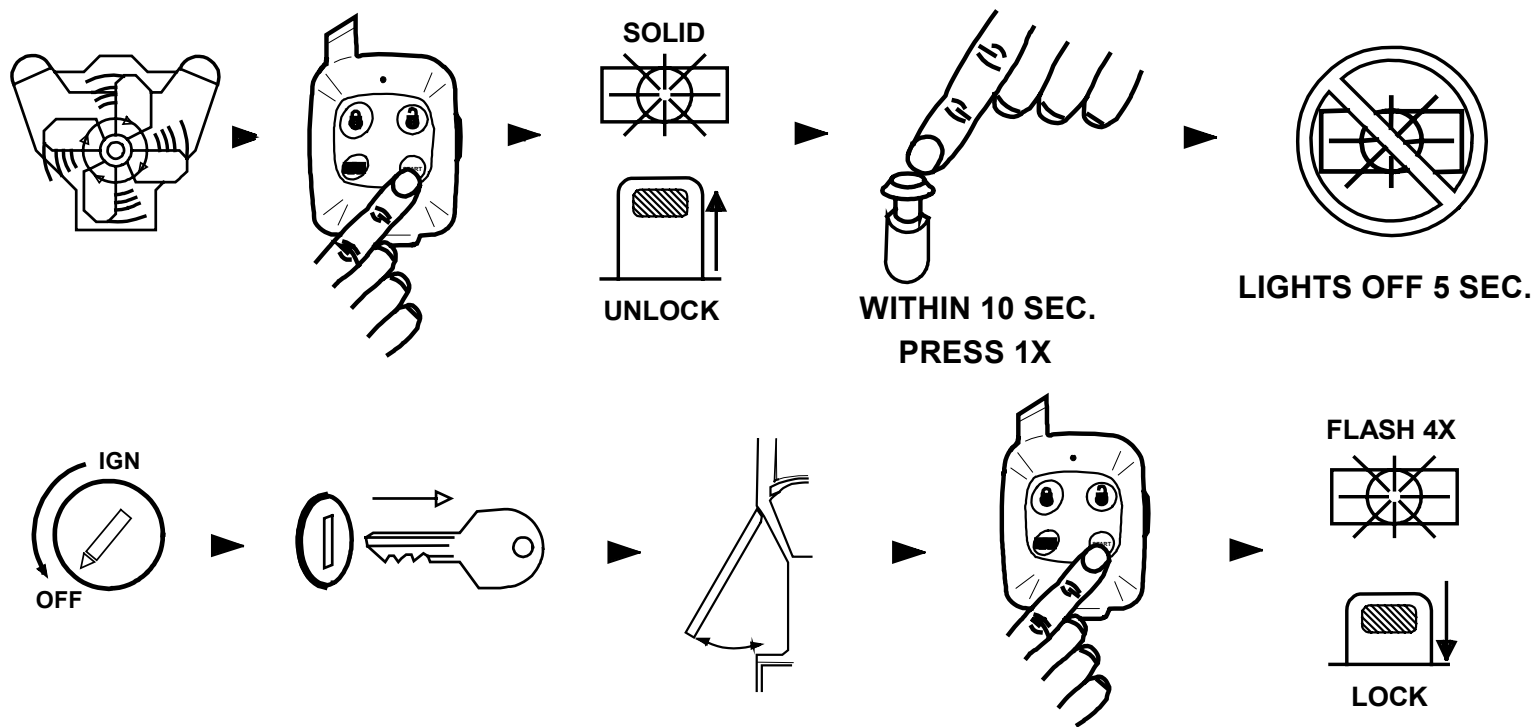

RESETTING TIMED SELF START MODE

To reset the timed self-start mode, start the vehicle using the key or the remote control

OPTIONAL TURBO TIMER MODE

OPTIONAL TURBO TIMER MODE:

IMPORTANT NOTE: This mode requires the use of an extra part called a momentary switch or button that is not included with the kit. Check with your installer about adding this feature. The optional Turbo Timer mode allows the your system to keep your vehicle running for 1 to 5 minutes [selectively] after you remove the key, exit the vehicle, and lock the doors remotely [if you own a Turbo or Turbo Diesel]. This is handy for turbo cool down without the need for expensive Turbo Timers.

- 1) Engine should be running with the key. Press and hold the brake pedal.
- 2) Press your "Turbo Timer" button 1 to 5 times for each minute of run time you desire. (1 press = 1 min.)
- 3) Release the brake pedal and your system will confirm by flashing the lights the same number of times the button was pressed.
- 4) Turn Ignition switch OFF, remove key and exit the vehicle. Remote lock your doors for safety. The engine should remain running for the selected number of minutes.

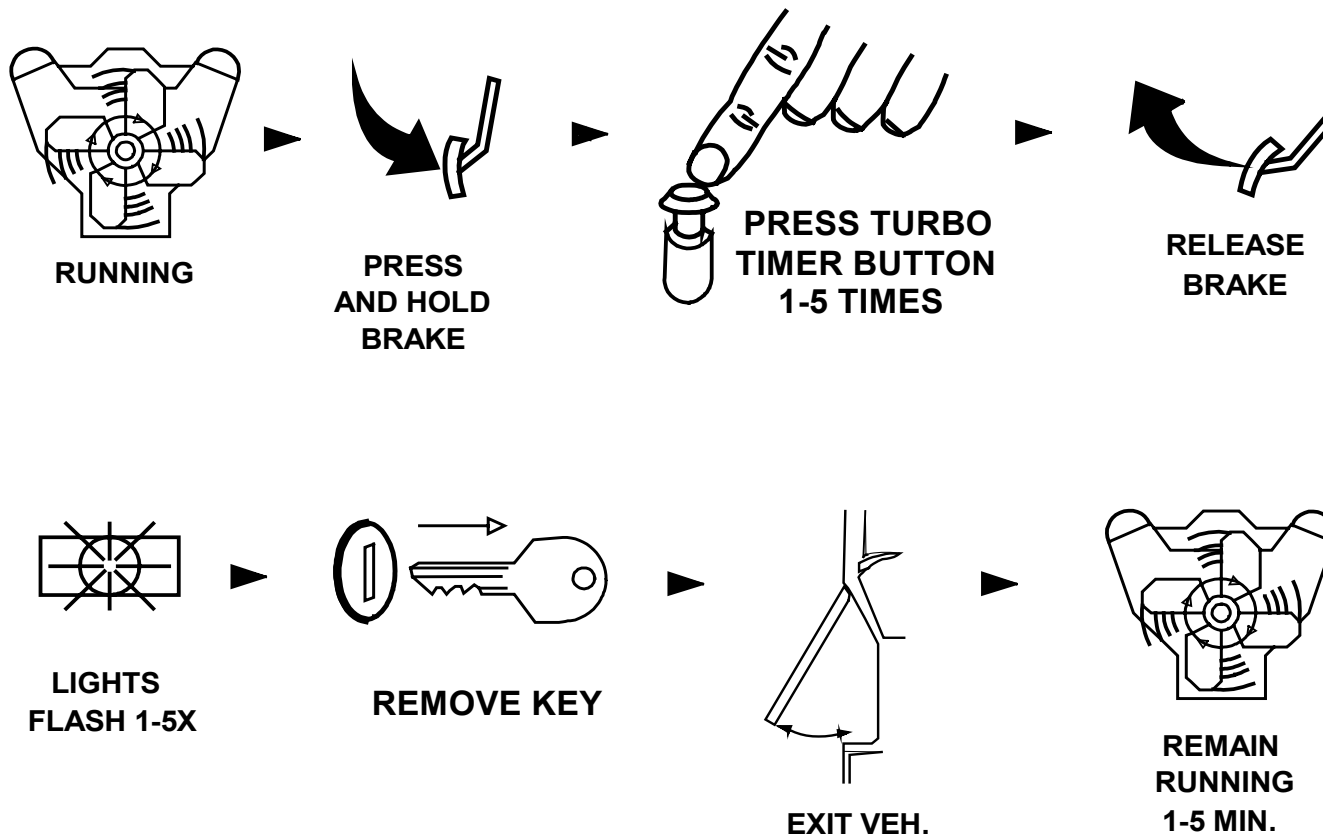

ANTI CARJACK PROTECTION

REMOTE OPERATED CARJACK PROTECTION

This feature provides Active Carjack protection through the remote control. When the Ignition is on (vehicle is running), press and hold the #1 LOCK Button and #3 TRUNK Button for 2 seconds. The parking lights will flash 2 times and the LED will begin to flash rapidly to confirm the beginning of a Carjack countdown. 30 Seconds later, the unit will begin a Carjack Cycle consisting of 20 seconds of pre-warning chirps turning into a full system activation with siren / flashing light pulses for up to 5 min. If the Ignition is turned off during a Carjack trigger the siren and lights stop but Carjack protection is still active. The Siren and Lights will resume if the Carjacker tries to turn the Ignition back ON. TO RESET: Press Button #2 (UNLOCK) on the remote and the siren will chirp once, or turn the key on and press and hold the override button for at least 5 seconds.

SWITCH-CONTROLLED & FULL TIME CARJACK (PINK WIRE CONFIGURATION)

This feature can provide Passive or Manual control Carjack protection depending on the configuration of the Pink Carjack wire of the alarm system. The system must be programmed for the Pink wire to be used as a Carjack trigger at Programming Option #8 in the Installation Manual. Once the Pink wire is programmed to serve as a Carjack trigger, it can be configured in different ways to provide different levels of protection. It can be connected to a hidden +12V toggle/momentary switch or to +12V Ignition Power. See installation manual. Read the sections below for further descriptions.

HIDDEN SWITCH CONTROLLED CARJACK:

This configuration will enable the vehicle owner to activate a Carjack countdown by pressing a hidden push-button (not included with kit) during a Carjack situation. A Carjack countdown will begin under the following conditions: Ignition is ON (vehicle is running), the push-button is pressed, and the door opens/closes. Upon these 3 events, in that order, the alarm will start a Carjack countdown. After a delay of one minute, the system will begin chirping for 20 seconds then trigger into a full cycle for up to 5 minutes. To reset this Carjack mode, Ignition must be ON then press and hold the override/valet button for 5 seconds (until LED goes out.)

FULL-TIME [Permanent] CARJACK WITH IGNITION ON:

We recommend that this configuration only be used in serious situations. When the Ignition is on (vehicle is running), anytime a door is opened the Carjack countdown sequence will be initiated. There will be 2 light flashes and the LED will change from solid to quick pulsing as confirmation of a countdown sequence. To reset FULL TIME Carjack, the Ignition has to be ON, then press and hold the override/program button 5 seconds until LED stops pulsing. The LED will be on SOLID when in this mode anytime the Ignition is ON (or while driving) as a reminder that Carjack is waiting for a door to open.

TRANSMITTER PROGRAMMING

Note: Remotes Transmitters come pre-programmed from the Factory. When re-learning remotes or adding remotes, ALL your system's remote codes must be learned at time of programming!! This system allow storage of up to 4 different remote codes in memory.

1. Open hood (ground the Blue hood pin wire if no hood pin is installed.)
2. Turn key to the ON position. (Starting the vehicle is not necessary.)
3. Press Program/Valet button 4 times. After a few seconds, the unit will flash the parking lights 4 times.
4. Press Button #1 (Lock) of the transmitter to be learned. You should get 2 light flashes indicating the code-learn. Now the unit is waiting for a 2nd code, so repeat this step as needed with up to 3 additional remotes. The unit will flash the lights in succession after each code learned for up to 4 codes. (2 flashes for the 2nd code, 3 flashes for the 3rd code etc.) If all 4 codes are learned, the unit will automatically exit code learning mode, otherwise turn key OFF and close the hood.

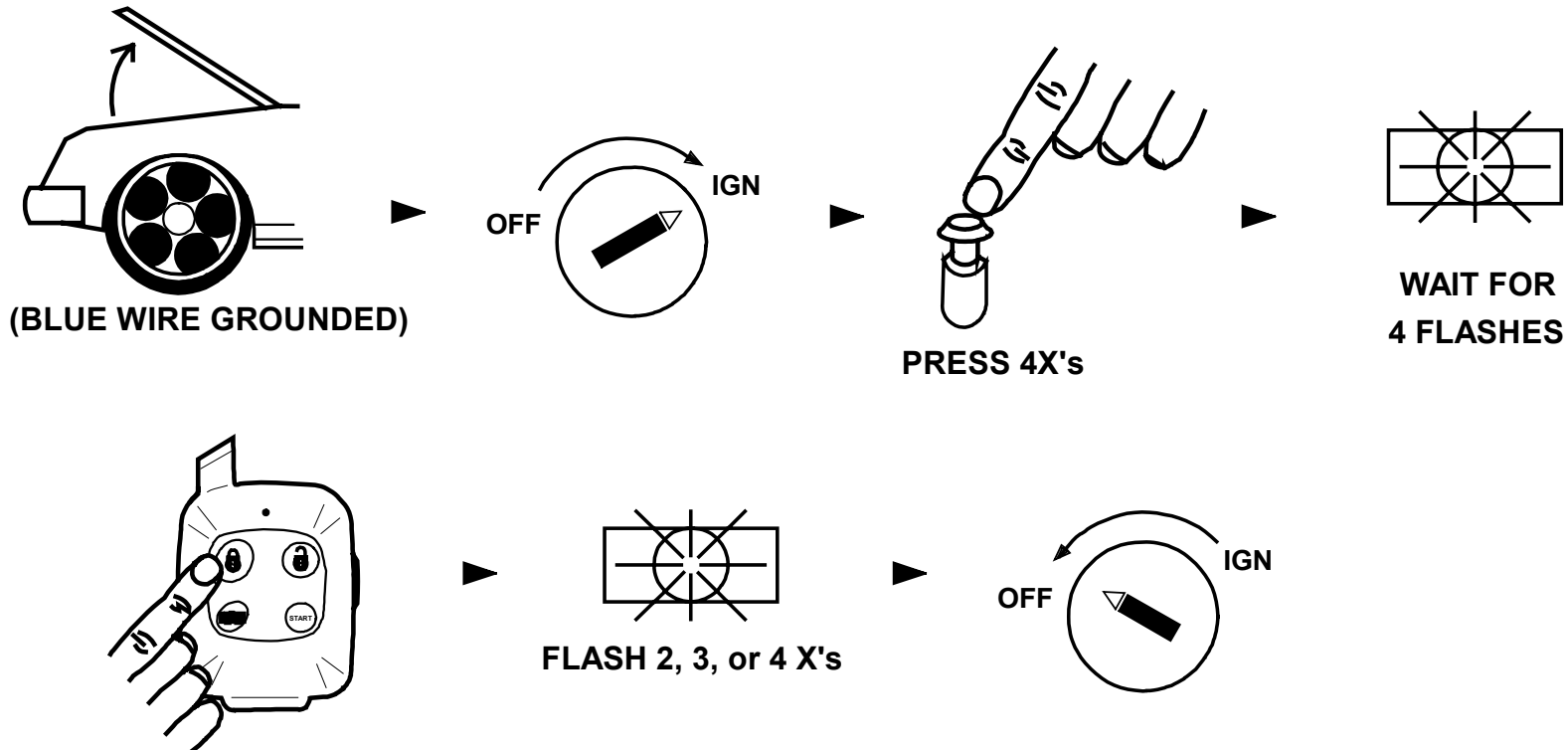

2 VEHICLE OPERATION

The CS-2011RS Series IV system can be used for 2 car operation. A single remote can control two independent vehicles with an identical systems installed.

See diagram below on how to switch your remote to car 2 operation. Follow the “Transmitter Programming” steps on the second vehicle and learn YOUR remote, along with Car #2’s existing remotes.

NEW Push-Button 2-Car method: *Your remote may have a push-button on the side in place of a slide-switch for 2-car operation. Please read the following: Your remote must be programmed to the second vehicle first. Press the side button on your remote first, and within 3 seconds, press any of the 4 function buttons on your remote. You can keep pressing function buttons to control car #2 as long as it is within the 3-second window. After 3 seconds have elapsed, the remote will revert back to Car #1 control.*

2-CAR OPERATION

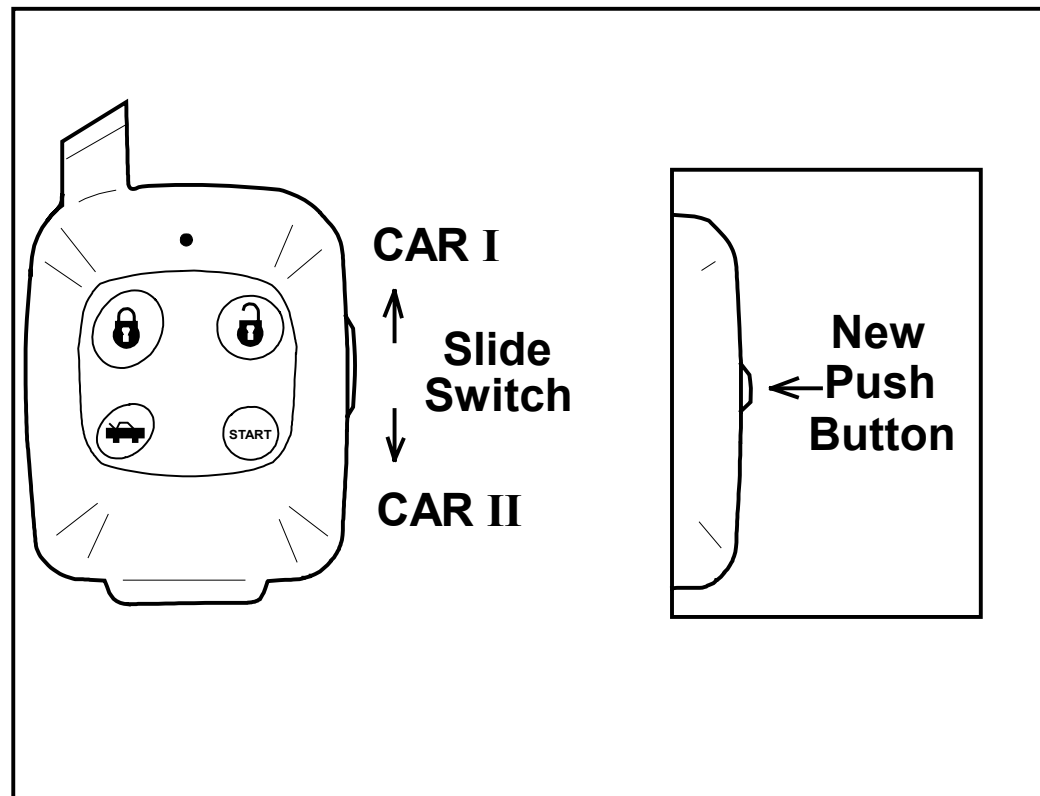

TROUBLESHOOTING: “BEFORE YOU CALL SECTION”

Before calling your dealer or Crimestopper, read the following section for tips that may remedy or explain your problem.

SYSTEM LED FLICKERS WHEN PRESSING REMOTE CONTROL BUTTONS:

This is normal operation. There may be a slight flicker visible from the LED when pressing the remote as the system is authorizing the code from the remote control. There is nothing wrong with your system.

UNIT CHIRPS 3X, FLASHES LIGHTS ONCE, BUT WILL NOT ATTEMPT A REMOTE START:

1. The system may sense a fault if the vehicle hood is up or open (Blue wire grounded). [Assuming you are using a grounding hoop pin or switch that is connected to the Blue wire of the system. This is a safety feature of the unit. Make sure hood is closed or that the Blue hood pin wire is not shorted to Ground.
2. The system may sense a fault at the Brake (White wire is active) check installation for faults and verify the +12V Brake input is not active unless the brake is pressed.

UNIT FLASHES THE LIGHTS ONCE AND WILL NOT ATTEMPT A REMOTE START:

The system is in Valet mode. Check the systems LED light and if it is on solid Red LED (with doors closed) then the system is in VALET mode. To exit VALET, turn the Ignition on, press and hold valet/programming button for about 5 seconds until LED goes out. Unit is now out of valet mode and should perform a remote start.

SYSTEM DOES NOT RESPOND TO THE REMOTE CONTROL:

1. Check for proper power/ground wiring connections of the alarm.
2. Check Antenna Module connection. The antenna included with this system must be plugged in to send/receive signals. Antenna Module gets voltage from the control module. See antenna diagram section in Installation Manual.
3. The Remote may need a new battery or need to be reprogrammed to operate the system. See “Transmitter programming” for more information.
4. Remote Transmitter may be out of synchronization with Receiver. Press the lock button 2-5 times slowly when near the vehicle until the vehicle begins to respond and recognize the remote. This is rare, but may happen after replacing the battery in the remote control.

CRIMESTOPPER

www.crimestopper.com
email@crimestopper.com
Phone (800) 998-6880
FAX (805) 581-9500

© 2003 Crimestopper Security Products

TechWeb

ONLINE TECHNICAL SUPPORT
www.crimestopper.com/techweb03.html