

PHILIPS **MAGNAVOX**

Video Cassette Recorder

VRZ241AT 
Easy Taping.

Owner's Manual

I M P O R T A N T !

Return Your Warranty Registration Card
Within 10 Days. See Why Inside.

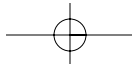

Return your Warranty Registration card today to ensure you receive all the benefits you're entitled to.

Once your PHILIPS MAGNAVOX purchase is registered, you're eligible to receive all the privileges of owning a PHILIPS MAGNAVOX product. So complete and return the Warranty Registration Card enclosed with your purchase at once. And take advantage of these important benefits.

Warranty Verification

Registering your product within 10 days confirms your right to maximum protection under the terms and conditions of your PHILIPS MAGNAVOX warranty.

Owner Confirmation

Your completed Warranty Registration Card serves as verification of ownership in the event of product theft or loss.

Model Registration

Returning your Warranty Registration Card right away guarantees you'll receive all the information and special offers which you qualify for as the owner of your model.

PHILIPS MAGNAVOX

Congratulations on your purchase, and welcome to the "family!"



Dear PHILIPS MAGNAVOX product owner:

Thank you for your confidence in PHILIPS MAGNAVOX. You've selected one of the best-built, best-backed products available today. And we'll do everything in our power to keep you happy with your purchase for many years to come.

As a member of the PHILIPS MAGNAVOX "family," you're entitled to protection by one of the most comprehensive warranties and outstanding service networks in the industry.

What's more, your purchase guarantees you'll receive all the information and special offers for which you qualify, plus easy access to accessories from our convenient home shopping network.

And most importantly you can count on our uncompromising commitment to your total satisfaction.

All of this is our way of saying welcome-and thanks for investing in a PHILIPS MAGNAVOX product.

Sincerely,

Robert Minkhorst
President and Chief Executive Officer

P.S. Remember, to get the most from your PHILIPS MAGNAVOX product, you must return your Warranty Registration Card within 10 days. So

Know these

safety symbols



This "bolt of lightning" indicates uninsulated material within your unit may cause an electrical shock. For the safety of everyone in your household, please do not remove product covering.

The "exclamation point" calls attention to features for which you should read the enclosed literature closely to prevent operating and maintenance problems.

WARNING: TO PREVENT FIRE OR SHOCK HAZARD, DO NOT EXPOSE THIS EQUIPMENT TO RAIN OR MOISTURE.

CAUTION: To prevent electric shock, match wide blade of plug to wide slot, and fully insert.

ATTENTION: Pour éviter les chocs électriques, introduire la lame la plus large de la fiche dans la borne correspondante de la prise et pousser jusqu'au fond.

For Customer Use

Enter below the Serial No. which is located on the rear of the cabinet. Retain this information for future reference.

Model No. _____
Serial No. _____

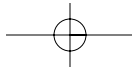

Introduction 3

Welcome to your VCR owner's manual.

This manual has six sections: Setting Up Your VCR; Description of Controls; Basic Operations; Recording; Playing; and Information You May Need. The instructions explain all of the VCR's features, which are listed below. You cannot hurt your VCR by trying the features! So read on – and relax.

Features

- High Quality (HQ) System
- Automatic Channel Setup
- On-Screen Displays in English or Spanish
- Display Panel
- Automatic Tracking Adjustment
- One-Touch Recording
- Timer Recording
- Special Effects Playback: Forward and Reverse Searching; Still; Slow Motion
- Remote Control with capability to operate TV, Cable Box, and Direct Broadcast System
- Repeat Play
- Automatic Operation Features
- Real-Time Counter
- Daylight-Saving Time
- The VCR Plus+ Programming System
- Time Search
- Automatic Head Cleaner

Safety Precautions

Warning: To prevent fire or shock hazard, do not expose this equipment to rain or moisture.

Federal Communications Commission Warning: Any unauthorized changes or modifications to this equipment void the user's authority to operate it.

This VCR is equipped with a High Quality (HQ) system and is compatible with existing Video Home System (VHS) equipment. Philips Consumer Electronics Company recommends that you use only video cassette tapes that have been tested and inspected for use in two, four, six, and eight hour VCRs, and which are labeled with the **VHS** mark. The use of tapes that have not been inspected for use in two, four, six, and eight hour VCRs may result in poor picture quality and excessive deposits on the video heads, which may not be covered by the warranty if damage occurs.

Note to the Cable TV System Installer: This reminder is provided to call the Cable TV system installer's attention to Article 820-40 of the National Electrical Code, which provides guidelines for proper grounding – in particular, specifying that the cable ground shall be connected to the grounding system of the building, as close to the point of cable entry as possible.

Copyright 1998 Philips Consumer Electronics Company. All rights reserved. VCR Plus+™ and PlusCode® are trademarks of Gemstar Development Corporation. The VCR Plus+ Programming system is manufactured under license from Gemstar Development Corporation.

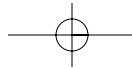

4 Table of Contents

Setting Up Your VCR

Introduction	3
Table of Contents	4
Before Using Your VCR	5
Hookups Without a Cable Box/Direct Broadcast System	6-7
Hookups With a Cable Box/Direct Broadcast System	8-9
Hookups With a Stereo TV	10
Turning on Your VCR	11
Automatic Channel Setup	12-14
Setting the Clock	15
Daylight-Saving Time	16
Language Selection	17
Setting the Remote to Operate a TV	18
Setting the Remote to Operate a Cable Box/Direct Broadcast System	19

Description of Controls

Remote Control Buttons	20-21
On-Screen Status Displays	22
VCR Display Panel	23
Front Panel	24
Rear Panel	25

Basic Operations

Playing	26
Recording	27

Recording

Recording One Channel/Watching Another	28
One-Touch Recording	29
Timer Recording	30-33
Setting Up the VCR Plus+ Programming System	34-35
Timer Recording With the VCR Plus+ Programming System	36-37
Rerecording (Tape Duplication)	38

Playing

Repeat Play	39
Time Search	40
Real-Time Counter Memory	41
Special Effects Playback	42
Automatic Operation Features	43

Information You May Need

Helpful Hints	44-45
Glossary	46
Specifications	47
Limited Warranty	48
Index	49
Supplied Accessories	52

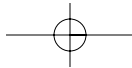

Before Using Your VCR 5

Removing the Plastic Cover from the Front Panel

A thin, plastic cover may protect the front panel of your VCR. Before using the VCR, lift a corner of the plastic, then peel it off.

Putting Batteries in the Remote Control

1

Remove the battery compartment lid on the bottom of the remote control by sliding it in the direction of the arrow.

2

Place two AA batteries inside the battery compartment with their + and - ends aligned as indicated.

3

Replace the battery compartment lid.

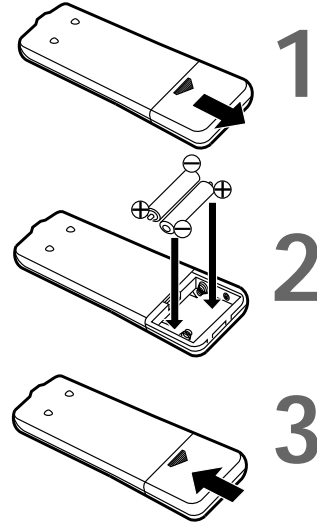

Using the Remote Control

- Point the remote control at the VCR, then press the VCR button, when using the remote control to operate the VCR.
- Point the remote control at the TV, then press the TV button, when using the remote control to operate the TV.
- Point the remote control at the Cable Box or Direct Broadcast System (DBS), then press the CBL/DBS button, when using the remote control to operate the Cable Box or DBS.

Erasure Prevention

Video cassette tapes have record tabs to ensure that recordings are not accidentally erased.

1

To prevent erasure, break off the tab with a screwdriver.

2

To record again, cover the hole with cellophane tape.

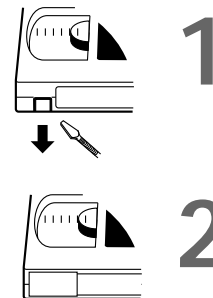

VCR maintenance

- Use only tapes with the **VHS** mark.
- Remove any light adhesive stick-on notes from the video cassette tape before putting the tape in the VCR. Removable labels can jam the VCR.
- Periodic maintenance is required to maintain your VCR's excellent performance. This VCR has an Automatic Head Cleaner. However, the video heads will require replacement eventually. Only an authorized service center should perform this service.

Helpful Hints

- Do not mix alkaline and manganese batteries.
- Do not mix old and new batteries.

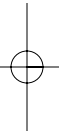
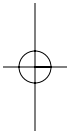

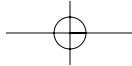

6 Hookups Without a Cable Box / Direct Broadcast System

The basic VCR/TV connection – antenna/cable to VCR to TV – is shown below. If you have a Cable Box or a Direct Broadcast System, please see pages eight-nine. If you have a Stereo TV, please see page 10. After you hook up the VCR, go to page 11 to turn on the VCR.

1

Disconnect the antenna or cable from your TV.

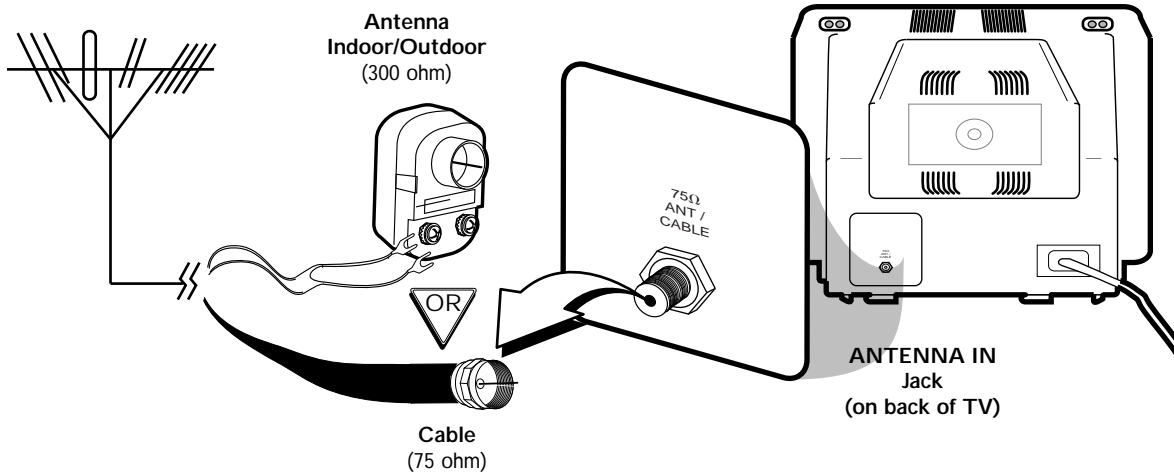

2

Connect the antenna or cable to the ANT(enna) IN Jack of your VCR.

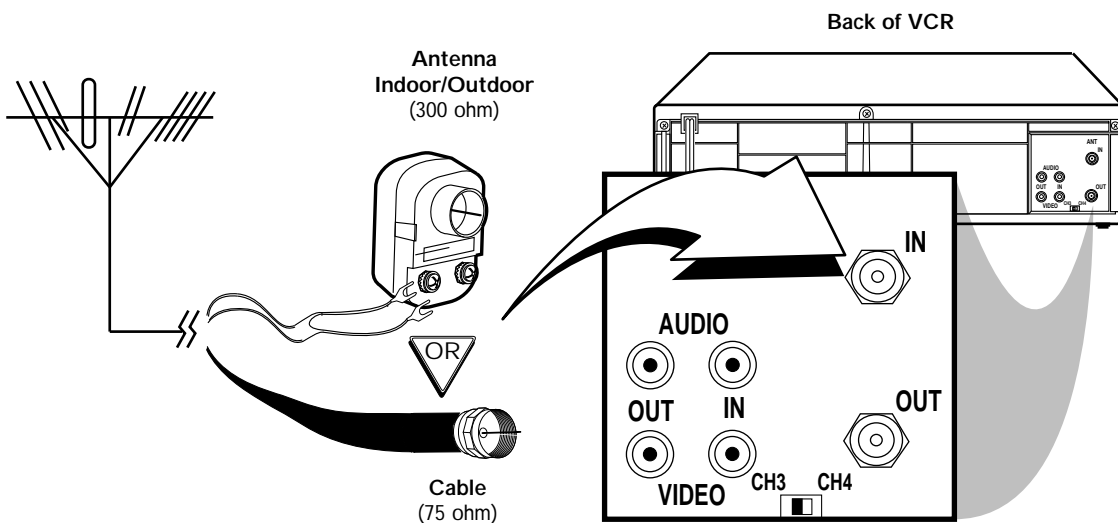

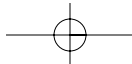

Hookups Without a Cable Box / Direct Broadcast System (cont'd) 7

3

Connect the RF coaxial cable (supplied) to the OUT Jack on the back of the VCR and to the ANTENNA IN Jack on the TV. (You may use either a snap-on type (supplied) or screw-on type of coaxial cable, whichever you prefer.)

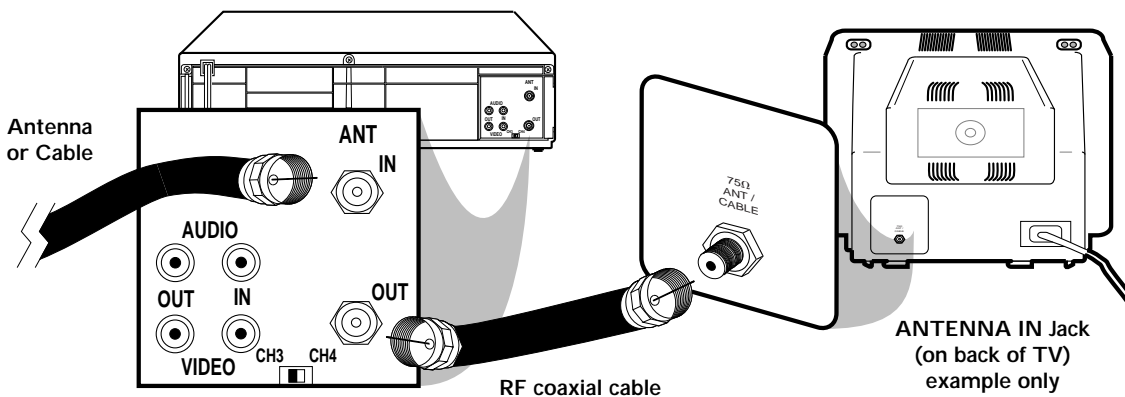

4

Plug in the TV and the VCR.

5

Set the CH3/CH4 switch on the back of the VCR to CH3 or CH4, whichever channel is not used or least used in your area. Set the TV to the same channel. For example, when playing a tape, if the CH3/CH4 switch is set to CH3, the TV should be on channel 03.

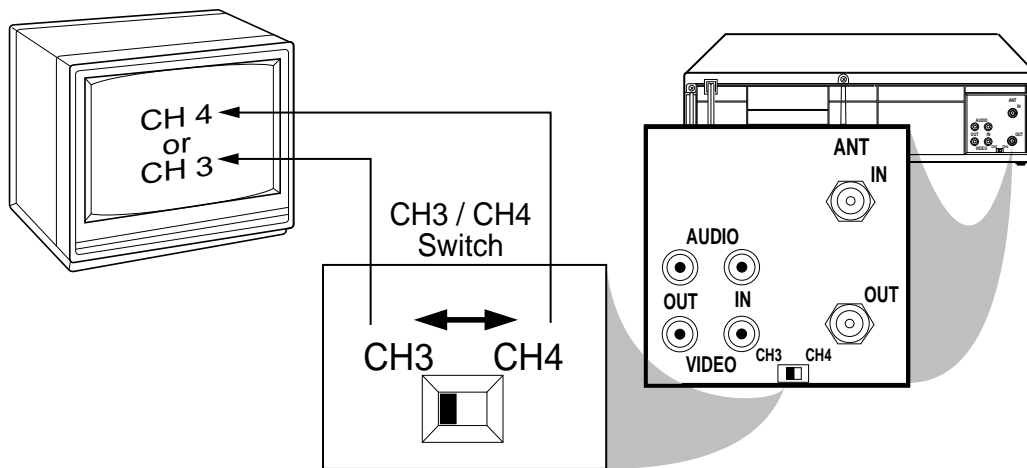

6

You are ready to turn on the VCR. Please go to page 11 before turning on the VCR.

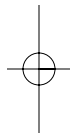
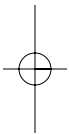

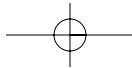

8 Hookups With a Cable Box / Direct Broadcast System

There are two ways to connect your Cable Box/DBS to the VCR. With this connection:

- You may view any channel.
- You must select channels at the Cable Box/DBS. Channels cannot be changed at the VCR.
- You may not view a channel other than the one you are recording.
- You may not program channels at the VCR.
- You can only program a timer recording for one channel at a time. Set the TV and the VCR to the Cable Box/DBS output channel (channel 03 or 04), and set your Cable Box/DBS to the channel you want to record. When you enter the channel you want to record in a timer recording, select channel 03 or 04 (the Cable Box/DBS output channel). (This is step 5 on page 31.) Leave the Cable Box/DBS on for a timer recording.

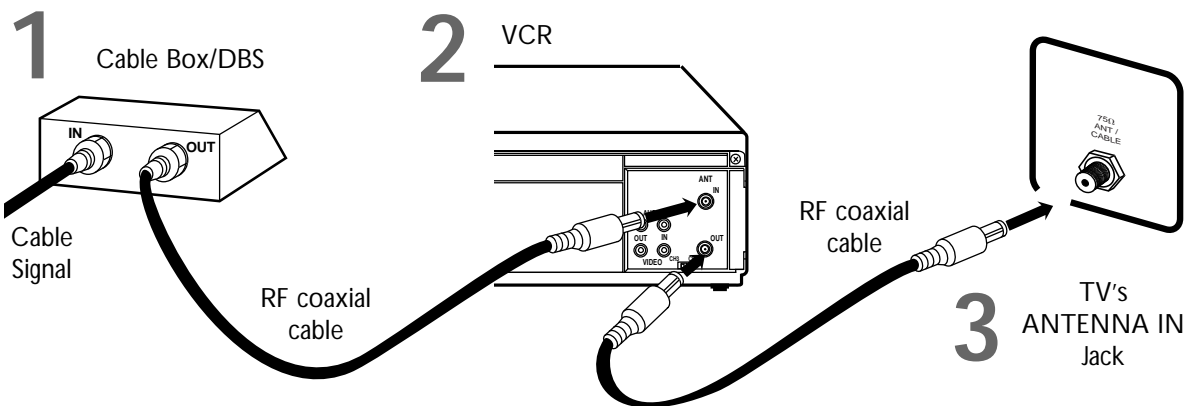

Connections

1

Connect a Cable signal to the IN Jack on the Cable Box/DBS.

2

Use an RF coaxial cable (supplied) to connect the OUT Jack on the Cable Box/DBS to the ANT(enna) IN Jack on the VCR.

3

Use a second RF coaxial cable to connect the OUT Jack on the VCR to the TV's ANTENNA IN Jack.

Recording/Viewing Any Channel

1

With the VCR on and in VCR position (the VCR light will appear on the display panel), use the **CHANNEL ▲/▼** buttons to set the VCR to the Cable Box/DBS output channel (channel 03 or 04).

2

Set the TV to the same channel to which you set the VCR.

3

Select the channel you want to view/record at the Cable Box/DBS.

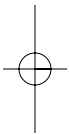

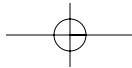

Hookups With a Cable Box / Direct Broadcast System (cont'd) 9

With this connection:

- You may watch one channel while recording another.
- You may not record scrambled channels.

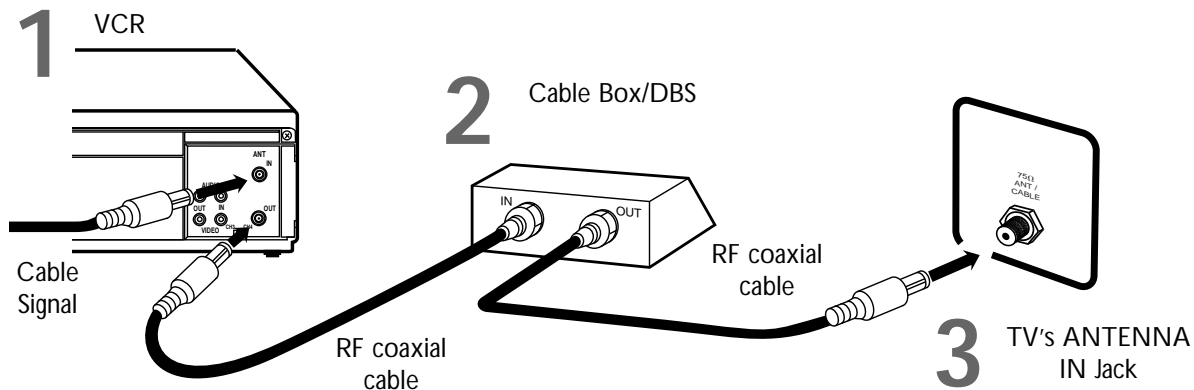

Connections

1

Connect a Cable signal to the VCR's ANT(enna) IN Jack.

2

Use an RF coaxial cable (supplied) to connect the OUT Jack on the VCR to the IN Jack on the Cable Box/DBS.

3

Use a second RF coaxial cable to connect the OUT Jack on the Cable Box/DBS to the ANTENNA IN Jack on the TV.

Recording One Channel/Watching Another

1

Put the Cable Box/DBS on the same channel as the VCR's CH3/CH4 switch. Then, with the VCR in VCR position (the VCR light will appear on the display panel), use the **CHANNEL ▲/▼** buttons to select the channel you want to record at the VCR. Start the recording.

2

Press the VCR/TV button once to put the VCR in TV position. (The VCR light will disappear.)

3

Set the TV to the Cable Box/DBS output channel (03 or 04).

4

Select the channel you want to watch at the Cable Box/DBS.

Helpful Hint

- When you play a tape, make sure the Cable Box/DBS is set to the same channel as the CH3/CH4 switch on the VCR. Set the TV to the Cable Box/DBS output channel (03 or 04).

10 Hookups With a Stereo TV

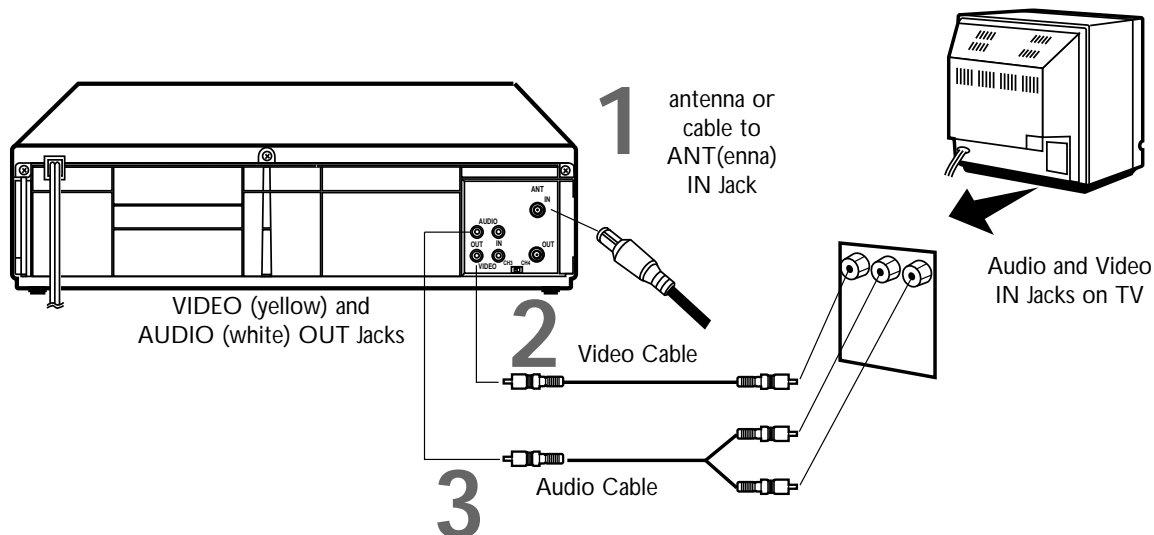

- Audio and Video cables are not supplied.

1

Connect the antenna or cable to the **ANT(enna) IN Jack** on the back of the VCR.

2

Connect a video cable to the yellow **VIDEO OUT Jack** on the back of the VCR. Then, connect the other end of the video cable to the **VIDEO IN Jack** on your TV.

3

Connect an audio cable to the white **AUDIO OUT Jack** on the back of the VCR. Then, connect the other end of the audio cable to the **AUDIO IN Jack** on your TV. (If your TV has Right and Left **AUDIO IN Jacks**, you must use a "Y" splitter audio cable as illustrated to deliver audio to the TV's right and left channels.)

4

Turn on your TV, making sure it is in Line Input mode. Please refer to your TV owner's manual for details.

Helpful Hint

- This hookup will not give you stereo sound. To get stereo sound, use the connections on pages six - seven and select the channel to be viewed at the TV (with the VCR turned off).

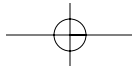

Turning on Your VCR 11

Before turning on your VCR, make sure there are batteries in the remote control and the VCR and TV are connected correctly.

- Follow the steps on this page only when you plug the VCR power cord into the wall outlet for the first time.
- You can not program channels if you are using a Cable Box or a Direct Broadcast System.

1

Press the **VCR** button, then the **POWER** button. The VCR light and the PWR. (power) light will appear on the display panel.

2

Turn on the TV. Set it to the same channel as the **CH3/CH4** switch on the back of the VCR. The display shown below will appear. (If the display does not appear, check your hookups, then follow the steps on page 12 to set up channels and page 17 to select a language.)

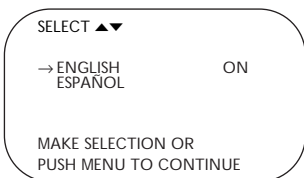

3

Within 60 seconds, press the **PLAY/▲** button or the **STOP/▼** button to select English or Spanish on-screen displays.

4

Press the **MENU** button. The display shown below will appear.

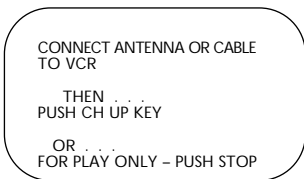

5

Within 60 seconds, press the **CHANNEL ▲** button to begin automatic channel programming. **AUTO SET PROCEEDING PLEASE WAIT** will appear on-screen. The VCR will memorize all available channels. When all channels are programmed, **CHANNELS ARE SET** will appear on-screen briefly, then TV programming will appear. Now, when you press the **CHANNEL ▲/▼** buttons, you'll only scan through channels that you receive.

2

Turn on the TV.

1

5

3

4

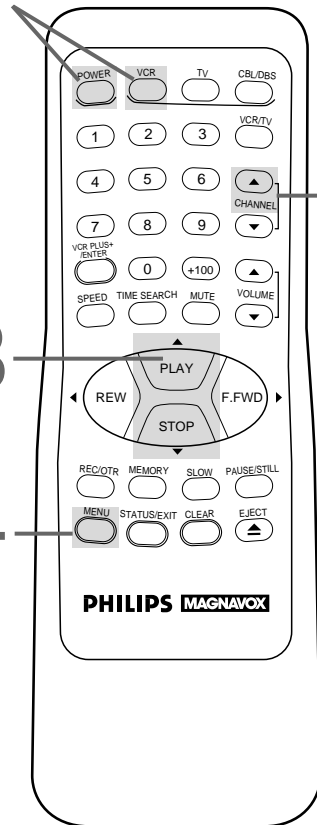

Helpful Hints

- To skip this feature and play a tape immediately, insert a tape with its record tab removed. Or, to skip step 3, press the **MENU** button. All on-screen displays will be in English. To skip step 5, press the **STOP** button. Channels will not be programmed, and **CHANNELS NOT SET** will appear on-screen.
- If you try to program channels when there is no antenna or cable connected to the VCR, programming will appear to take place, but eventually a **NO TV SIGNALS** message will appear. Connect an antenna or cable to the VCR's **ANT(enna) IN Jack** and try again. You may need to follow the steps on page 12.

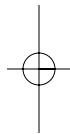
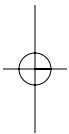

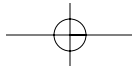

12 Automatic Channel Setup

Although your VCR may automatically memorize the channels you receive when you turn it on for the first time, this function lets you set up the channels again.

1

Press the **VCR** button.

2

Press the **MENU** button.

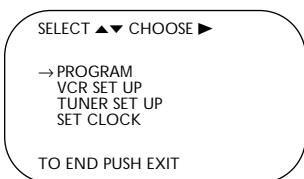

3

Press the **PLAY/▲** button or the **STOP/▼** button to select **TUNER SET UP**, then press the **F.FWD/▶** button.

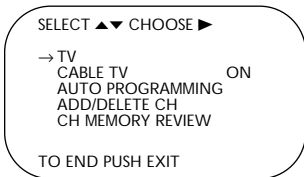

4

Press the **PLAY/▲** button or the **STOP/▼** button to select **TV** (if you have an antenna) or **CABLE TV** (if you have a cable connection). Then, press the **F.FWD/▶** button. **ON** will appear beside your choice.

5

Press the **PLAY/▲** button or the **STOP/▼** button to select **AUTO PROGRAMMING**, then press the **F.FWD/▶** button. The VCR will place all the channels you receive into its memory.

6

Wait for a few minutes while the VCR sets up the channels. When this is complete, **CHANNELS ARE SET** will appear on-screen. Then the programming of the lowest channel number placed in the VCR's memory will appear on-screen. Now when you press the **CHANNEL ▲/▼** buttons, you will scan only through channels you receive.

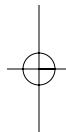
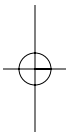
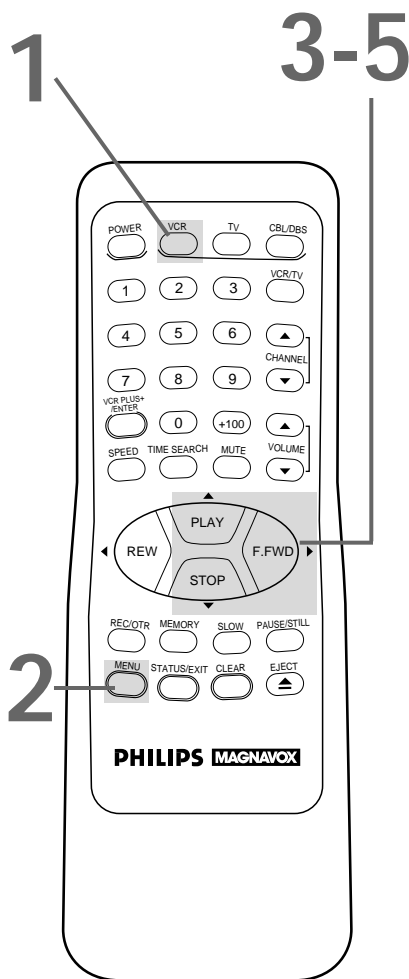

Helpful Hints

- You can not enter the **TUNER SET UP** menu when you are in **Line Input mode (channel 001 or 002)**. When you select channel **001** or **002**, **AV REAR** or **AV FRONT** will appear on-screen briefly.
- You can not program channels if you are using a **Cable Box** or **DBS**.

Automatic Channel Setup (cont'd) 13

Adding/Deleting Channels

1

Press the VCR button.

2

Press the MENU button.

3

Press the PLAY/▲ button or the STOP/▼ button to select TUNER SET UP, then press the F.FWD/▶ button.

4

Press the PLAY/▲ button or the STOP/▼ button to select ADD/DELETE CH, then press the F.FWD/▶ button.

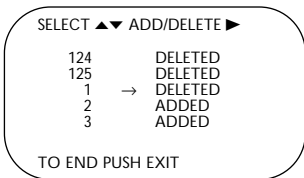

5

Press the PLAY/▲ button or the STOP/▼ button until the channel number you want to add or delete appears beside the arrow.

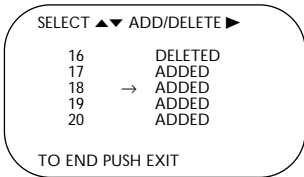

6

Press the F.FWD/▶ button to select ADDED or DELETED.

7

Press the STATUS/EXIT button.

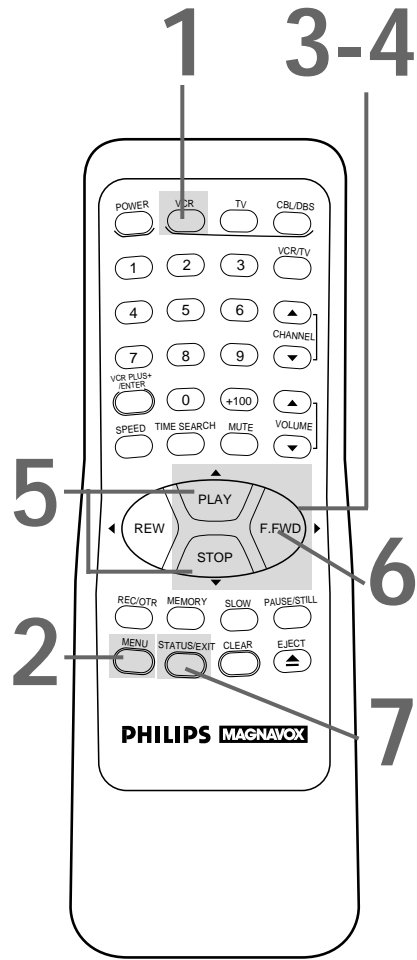

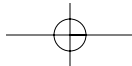

14 Automatic Channel Setup (cont'd)

Reviewing Memorized Channels

1

Press the VCR button.

2

Press the MENU button.

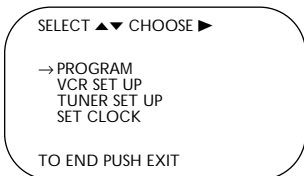

3

Press the PLAY/▲ button or the STOP/▼ button to select TUNER SET UP, then press the F.FWD/▶ button.

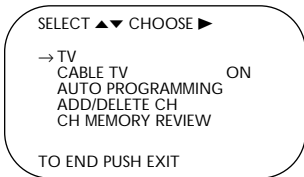

4

Press the PLAY/▲ button or the STOP/▼ button to select CH MEMORY REVIEW, then press the F.FWD/▶ button. A list of programmed channels will appear on-screen.

- If all the programmed channels don't fit on the screen, press the F.FWD/▶ button to see the remaining channels. Then press the REW(ind)/◀ button to return to the first screen of channels.
- If you do not press any buttons within 10 seconds, you will either go to the next screen of channels or you will return to the previous menu.

5

Press the STATUS/EXIT button once or twice to exit.

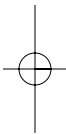
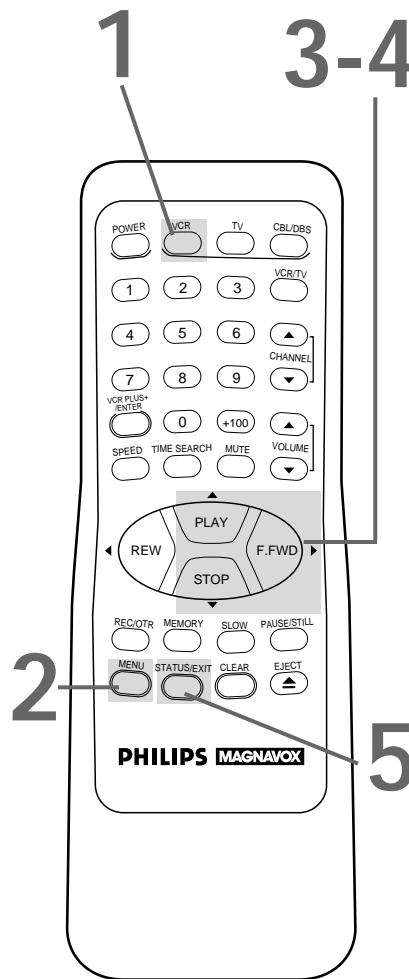

Setting the Clock 15

Follow the steps below to set your VCR's clock. Make sure:

- The VCR is on and the VCR light appears on the display panel. (If it does not, press the VCR/TV button once.)
- You make each entry within 60 seconds of the previous entry.

1

Press the VCR button.

2

Press the MENU button.

3

Press the PLAY/▲ button or the STOP/▼ button to select SET CLOCK, then press the F.FWD/► button.

4

Press the PLAY/▲ button or the STOP/▼ button to select SET CLOCK, then press the F.FWD/► button.

5

Press two Number buttons for the hour(s) and two Number buttons for the minute(s). Then press 1 for AM or 2 for PM. For example, for 2:15 PM, press 02, 15, 2.

6

Press two Number buttons for the month, two Number buttons for the day, and two Number buttons for the year. For example, for July 1, 1998, press 07, 01, 98. The day of the week will appear automatically.

7

Press the STATUS/EXIT button.

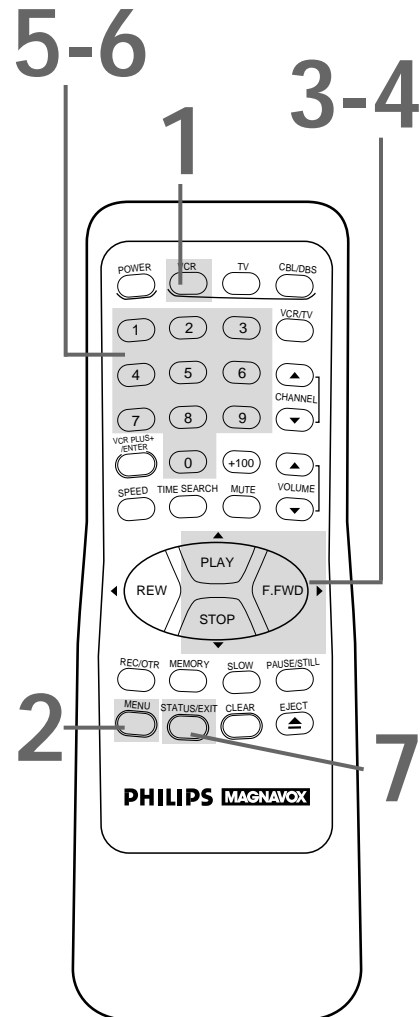

Helpful Hints

- Enter a 0 before a single digit number.
- Entries that do not match the VCR's calendar will cause a question mark to appear on-screen.
- To make corrections, press the CLEAR button until the space for the number you want to correct is flashing. Then enter the correct number.
- The current time will appear on the VCR display panel when the clock is set. The current time will also appear on-screen if you press the STATUS/EXIT button. (See page 22 for details.)
- Power failures that last for more than one minute can cause you to lose your clock setting.

16 Daylight-Saving Time

You may program the VCR so its clock will automatically move forward one hour in April and turn back one hour in October. Daylight-Saving Time is set to ON when you receive your VCR. Turn Daylight-Saving Time ON or OFF by following the steps below. Before you begin:

- Make sure the clock is set.

1

Press the VCR button.

2

Press the MENU button.

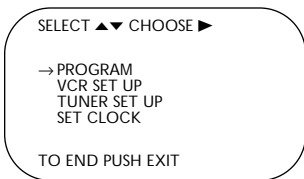

3

Press the PLAY/▲ button or the STOP/▼ button to select SET CLOCK, then press the F.FWD/► button.

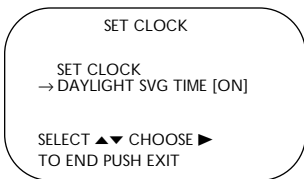

4

Press the PLAY/▲ button or the STOP/▼ button to select DAYLIGHT SVG TIME. Then, press the F.FWD/► button so that OFF (or ON) appears beside DAYLIGHT SVG TIME.

5

Press the STATUS/EXIT button.

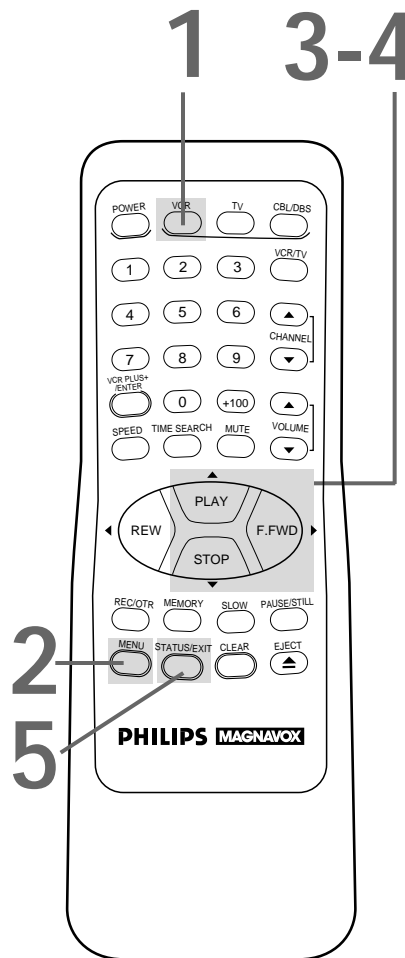

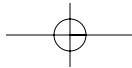

Language Selection 17

Follow the steps below to change the language of the on-screen displays.

1

Press the **VCR** button.

2

Press the **MENU** button.

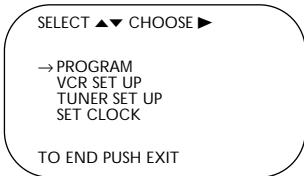

3

Press the **PLAY/▲** button or the **STOP/▼** button to select **VCR SET UP**, then press the **F.FWD/▶** button.

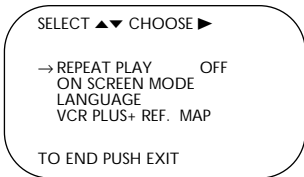

4

Press the **PLAY/▲** button or the **STOP/▼** button to select **LANGUAGE**, then press the **F.FWD/▶** button.

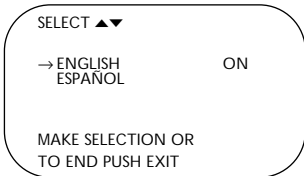

5

Press the **PLAY/▲** button or the **STOP/▼** button to select **English** or **Spanish** on-screen displays.

6

Press the **STATUS/EXIT** button.

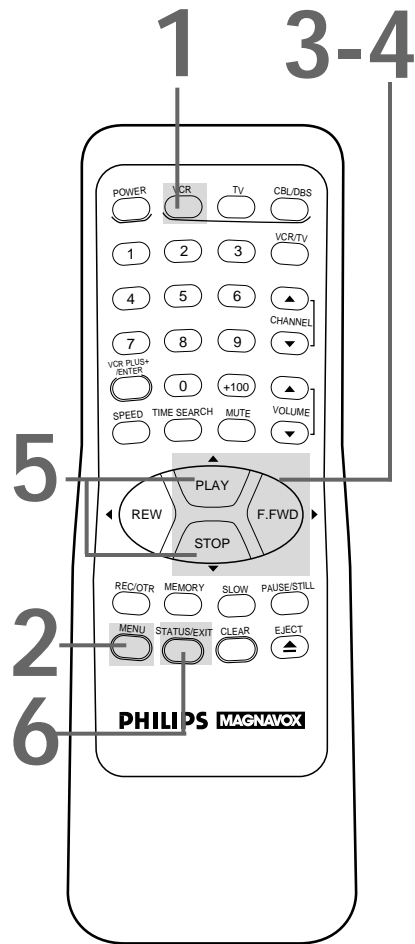

Helpful Hint

- If you accidentally select Spanish on-screen displays and need English on-screen displays:
 1. Press the **VCR** button.
 2. Press the **MENU** button.
 3. Press the **PLAY/▲** button or the **STOP/▼** button to select **PREPARE EL VCR**, then press the **F.FWD/▶** button.
 4. Press the **PLAY/▲** button or the **STOP/▼** button to select **LENGUAJE**, then press the **F.FWD/▶** button.
 5. Press the **PLAY/▲** button or the **STOP/▼** button to select **ENGLISH**.
 6. Press the **STATUS/EXIT** button.

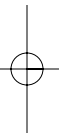
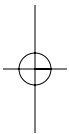

18 Setting the Remote to Operate a TV

Your VCR remote control **may** operate your TV. If the remote control doesn't operate your TV now, follow the steps below.

1

Point the remote control at your TV and press the TV button. Then, press the POWER button. If your TV turns on or off, try the other TV buttons (see pages 20 - 21). If your TV doesn't turn on or off, or if the other buttons don't work, go to step 2.

2

Find the brand of your TV on the list below, and remember the two-digit number beside it.

TV CODES			
EMERSON14	PHILCO14
FISHER11	PHILIPS01
GE10	PHILIPS MAGNAVOX	.01, 02, 03
GOLDSTAR04	QUASAR07
HITACHI12	RCA10
JVC05	SAMSUNG17
MAGNAVOX01, 02, 03	SANYO11
MARANTZ13	SEARS08, 11
MITSUBISHI13	SHARP16
MONTGOMERY WARD14	SONY09
PANASONIC07	TOSHIBA08
PANASONIC-GAOO07	ZENITH06, 15

3

Press the MUTE button.

4

Within 30 seconds, press the TV button.

5

Within 30 seconds, press the Number buttons to enter the two-digit code for your TV brand. For example, if you have a Zenith TV, press Number buttons 0, 6.

6

Repeat step 1. If the remote control works your TV, you're finished. If the remote control still doesn't work your TV, repeat steps 3 - 5, using another code for your brand.

There is no guarantee that the remote will work your TV.

1&6 Find your TV code.

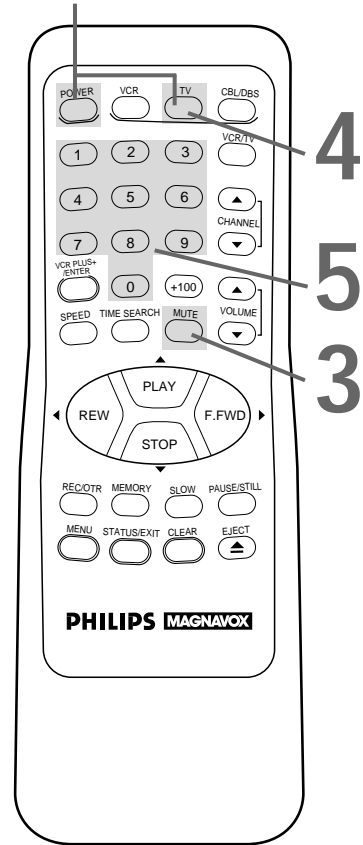

Helpful Hints

- The remote control may only operate some features of your TV. For example, the remote control may turn on the TV power, but it may not change channels at the TV.
- If you can not change the channels at the TV using the Number buttons, press the VCR PLUS+/ENTER button after you press the Number buttons. It may change channels at the TV.
- When you replace the batteries in the remote control, you must program the remote control again.

Setting the Remote to Operate a Cable Box/Direct Broadcast System 19

Your VCR remote control **may** operate your Cable Box or Direct Broadcast System (DBS). If the remote control doesn't operate your Cable Box or DBS now, follow the steps below.

1

Point the remote control at your Cable Box or DBS and press the CBL/DBS button. Then, press the POWER button. If your Cable Box or DBS turns on or off, try the other Cable Box/DBS buttons (see pages 20 - 21). If your Cable Box or DBS doesn't turn on or off, or if the other buttons don't work, go to step 2.

2

Find the brand of your Cable Box or DBS on the lists below and remember the two-digit number beside it.

CABLE BOX CODES		
ARCHER.....01, 05, 06, 44	MAGNAVOX.....26	SAMSUNG.....05, 06, 40, 42
CABLETENNA.....01, 44	MATSUSHITA.....16, 17, 97	SCIENTIFIC ATLANTA.....08, 09
CABLEVIEW.....04, 30, 42, 44, 52	MOVIE TIME.....42, 44	SIGNAL.....26
CENTURY.....44	NOVAVISION.....08, 09	SL MARX.....06, 40, 42, 44, 52
CITIZEN.....04, 30, 42, 44, 52	NSC/NEC.....40	SPRUCER.....16, 17, 97
CURTIS.....08, 09	OAK.....11, 46	STANDARD COMPONENTS.....42, 44
DIAMOND.....01, 44	OAK SIGMA.....11, 46	STARGATE.....04, 06, 30, 40, 42, 44, 52
EAGLE.....26, 40, 62	PANASONIC.....16, 17, 97	TELEVIEW.....06, 40, 42
EASTERN/REGENCY.....28	PHILIPS.....07, 23, 50	TOCOM.....01, 33, 34, 42
GC BRAND.....04, 30, 42, 44, 52	PIONEER.....05, 06	UNIKA.....01, 44
GEMINI/JASCO.....04	PULSAR.....04, 30, 42, 44, 52	UNIVERSAL.....42, 44, 52
GENERAL ELECTRIC.....01, 57	QUEST.....05, 06	VIDEOWAY.....07, 23, 50
GENERAL INSTRUMENT.....01, 02, 03, 04, 34, 83	RCA.....16, 17, 97	VIEWSTAR.....26, 40, 62
HAMLIN.....14, 15, 28, 41	REALISTIC.....44	ZENITH.....07, 23, 50
JERROLD.....01, 02, 03, 04, 34, 83	RECOTON.....44	
	REGAL.....14, 15, 28, 41	
	REMBRANDT.....01, 42, 44	

DIRECT BROADCAST SYSTEM CODES		
MAGNAVOX.....94,95	RCA.....97	SONY.....98

3

Press the MUTE button.

4

Within 30 seconds, press the CBL/DBS button.

5

Within 30 seconds, press the Number buttons to enter the two-digit code for your Cable Box or DBS. For example, if you have a Zenith Cable Box, press Number buttons 2, 3.

6

Repeat step 1. If the remote control works your Cable Box or DBS, you're finished. If the remote control still doesn't work your Cable Box or DBS, repeat steps 2 - 5, using a different code.

1 & 6 Find your code.

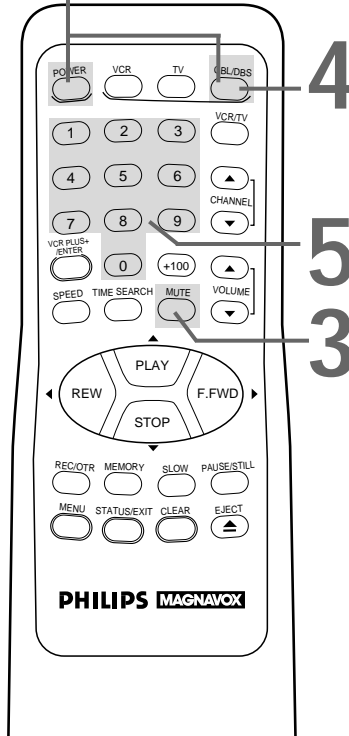

There is no guarantee that the remote control will work your Cable Box or DBS.

Helpful Hints

- The remote control may only operate some features of your Cable Box or DBS. For example, the remote control may turn on the Cable Box or DBS power, but it may not change channels at the Cable Box or DBS.
- If you can not change the channels at the Cable Box by using the Number buttons, press the VCR PLUS+/ENTER button after you press the Number buttons. It may change channels at the Cable Box.
- When you replace the batteries in the remote control, you will have to program the remote control again.

20 Remote Control Buttons

POWER Button

Press to turn on or off the VCR, TV, Cable Box, or Direct Broadcast System. (You must first press the VCR, TV, or CBL/DBS button.)

Number Buttons

Use to select channels at the VCR, TV, Cable Box, or Direct Broadcast System; use to set up VCR features (such as the clock).

Channels 1 - 9 ●

To select, press 0, then the channel number you want. For example, to select channel 7, press 0, 7.

Channels 100 and above ●

To select, press the +100 button, then press the last two digits of the channel you want. For example, to select channel 117, press the +100 button, 1, 7.

VCR PLUS+/ENTER Button

Press to set a timer recording with the VCR Plus+ programming system. *Details are on pages 34 - 37.*
Or, press after pressing the Number buttons to select a channel at the TV or the Cable Box. *Details are on pages 18 - 19.*

SPEED Button

Press to select the recording speed (SP, LP, or SLP). *Details are on pages 32 and 46.*

TIME SEARCH Button

Press to fast forward or rewind the tape a specific length of time. *Details are on page 40.*

REW(ind)/◀ Button

When tape playback is stopped, press to rewind the tape at high speed. During playback, press to rewind the tape while the picture stays on-screen. *Details are on page 42.* Or, if you have a Magnavox TV, use the REW(ind) button to adjust the picture controls in the TV menu.

MEMORY Button

Press to memorize a tape position at which the real-time counter was set to 0:00:00. *Details are on page 41.*

REC(ord)/OTR Button

Press once to start a recording. *Details are on page 27.* Or, press repeatedly to start a One-Touch Recording. *Details are on page 29.*

MENU Button

Press to access the VCR menu. Or, if you have a Magnavox TV, press the TV button, then press the MENU button to display the TV menu.

STATUS/EXIT Button

Press to access or remove the on-screen status display. *Details are on page 22.* Press to exit on-screen menus. Or, if you have a Magnavox TV, press the TV button, then press the STATUS/EXIT button, to see a TV status display or to remove the TV menu.

PLAY/▶ Button

Press to play a tape; press to release Slow, Search, or Still mode and return to normal playback. *Details are on page 42.* Press to select an item in the on-screen menu. Or, if you have a Magnavox TV, press when in TV mode to move up one row or selection in the TV menu.

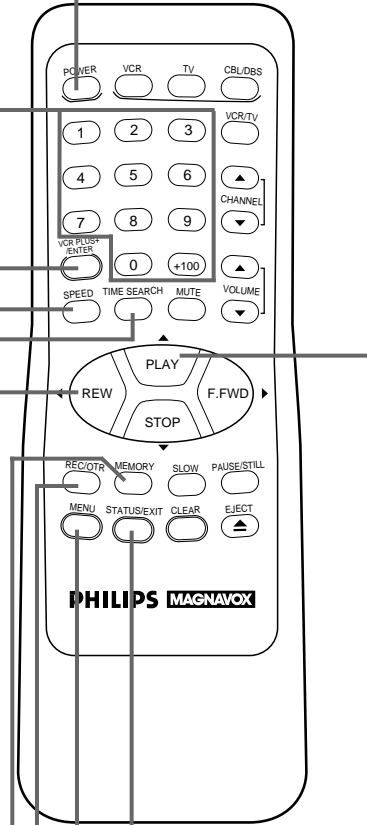

Helpful Hint

- Press the VCR button before pressing VCR feature buttons; press the TV button before pressing TV feature buttons; press the CBL/DBS button before pressing Cable Box/DBS feature buttons.

Remote Control Buttons (cont'd) 21

CBL/DBS Button
 Press to operate the Cable Box or Direct Broadcast System. *Details are on page 19.*

TV Button
 Press to operate the TV. *Details are on page 18.*

VCR Button
 Press to operate the VCR.

VCR/TV Button
 Use to select VCR or TV position.

VCR Position ●
 Use to watch a tape, to watch a program while recording it, or to watch a TV program (changing channels at the VCR). If the VCR light appears on the display panel of the VCR, it is in VCR position.

TV Position ●
 Use to watch a TV program (changing channels at the TV) or to watch one program while recording another. *Details are on page 28.* If the VCR light doesn't appear on the display panel, the VCR is in TV position.

CHANNEL ▲/▼ Buttons
 Press to change channels at the VCR, TV, Cable Box, or Direct Broadcast System.

VOLUME ▲/▼ Buttons
 Press to adjust the TV's volume.

MUTE Button
 Press to eliminate the TV's sound. Press again to restore the volume.

STOP/▼ Button
 Press to stop the tape. Press to select an item in the VCR menu. Or, if you have a Magnavox TV, press when in TV mode to move down one row or selection in the TV menu.

SLOW Button
 During tape playback, press to view the picture in slow motion. Press again to resume normal playback.

CLEAR Button
 Press to erase incorrect information when programming VCR features. Press to reset the real-time counter. *Details are on page 41.*

EJECT Button
 Press to eject the tape.

PAUSE/STILL Button
 During recording, press to pause the recording. Press a second time to resume normal recording. *Details are on page 27.* You can not pause a One-Touch Recording. During playback, press to freeze the picture. Press again to resume playback. *Details are on page 42.*

F.FWD(Fast Forward)▶ Button
 When playback is stopped, press to fast forward the tape at high speed. During playback, press to fast forward the tape while the picture stays on-screen. *Details are on page 42.* Or, if you have a Magnavox TV, use to adjust the picture controls in the TV menu.

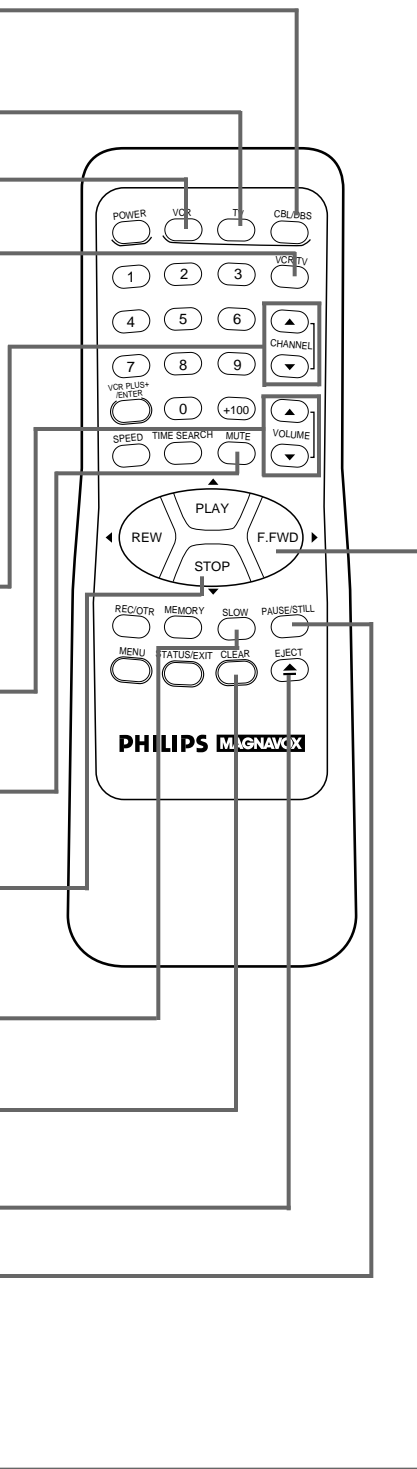

Helpful Hint

- Buttons with a shaded description may also operate features of your TV, Cable Box, or DBS.

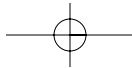

22 On-Screen Status Displays

A status display will appear when you press the STATUS/EXIT button or certain function buttons. The contents of the status display will vary. To choose the status display mode, follow the steps below.

If you select STATUS ON, then select COUNTER ONLY ON:

- Whenever you press the STOP/▼ button or the PLAY/▲ button, the status display will appear for five seconds. After five seconds, only the counter will remain on-screen. You must press the STATUS/EXIT button to remove it.

If you select STATUS ON, then select COUNTER ONLY OFF:

- Whenever you press the STOP/▼ button or the PLAY/▲ button, the status display will appear for five seconds.

If you select STATUS OFF:

- The status display will not appear when you press function buttons. You must press the STATUS/EXIT button to see the status display.

1

Press the VCR button, then press the MENU button.

2

Press the PLAY/▲ button or the STOP/▼ button to select VCR SET UP, then press the F.FWD/▶ button.

3

Press the PLAY/▲ button or the STOP/▼ button to select ON SCREEN MODE, then press the F.FWD/▶ button.

4

Press the PLAY/▲ button or the STOP/▼ button to select STATUS, then press the F.FWD/▶ button so that OFF (or ON) appears beside STATUS.

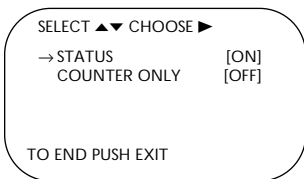

5

If you set STATUS to OFF, go to step 6. If you set STATUS to ON, press the PLAY/▲ button or the STOP/▼ button to select COUNTER ONLY, then press the F.FWD/▶ button so that OFF (or ON) appears beside it.

6

Press the STATUS/EXIT button.

Status Display (example only)

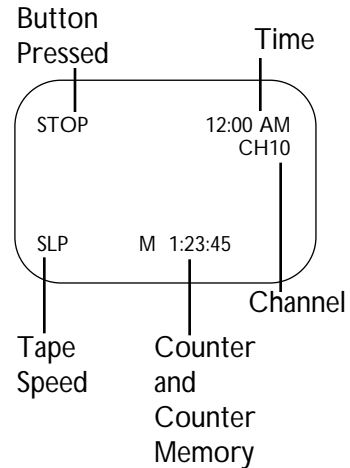

Press the PLAY/▲ button or the STOP/▼ button to select VCR SET UP, then press the F.FWD/▶ button.

Press the PLAY/▲ button or the STOP/▼ button to select ON SCREEN MODE, then press the F.FWD/▶ button.

Press the PLAY/▲ button or the STOP/▼ button to select STATUS, then press the F.FWD/▶ button so that OFF (or ON) appears beside STATUS.

Helpful Hints

- If the channel you select has no broadcast, the screen will become solid blue.
- You may not access a status display when viewing a still picture, during slow motion playback, or when the F.FWD/▶ or REW(ind)/◀ button is pressed during playback.

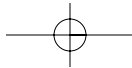

VCR Display Panel 23

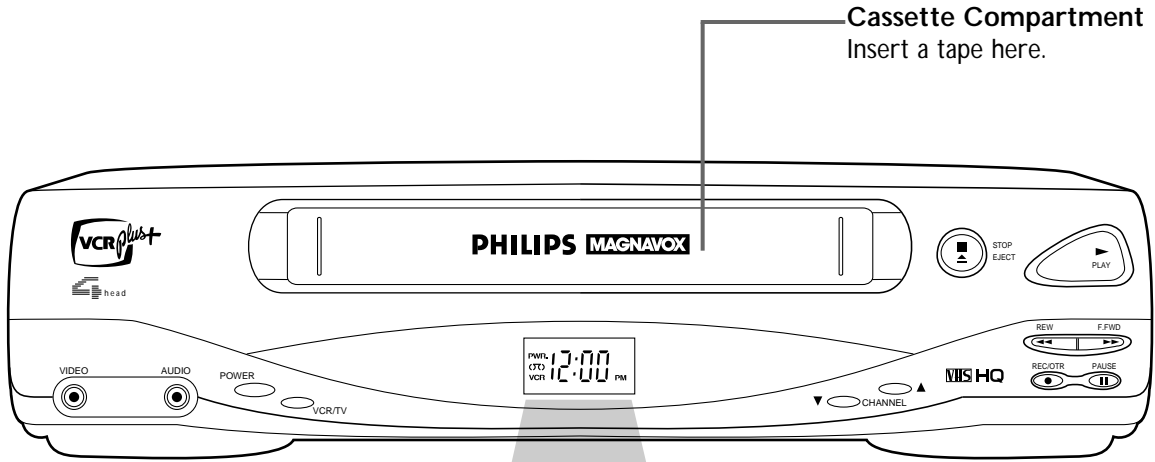

PWR.(power) Light
This light appears when the power is on.

Cassette-Inside Light
This light appears when there is a tape in the VCR.

VCR Light
This light appears when the VCR is in VCR position. This light does not appear when the VCR is in TV position.

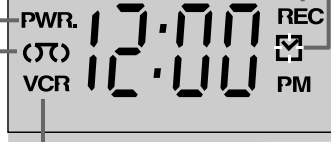

Clock Display
The current time appears here when the clock is set. If the clock is not set, --:-- will appear here. PM will appear on the display, but AM will not.

REC(ord) Light
This light appears during a recording. It flashes when a recording is paused.

Timer Light
This light glows when the VCR is turned off to set a timer recording or during a One-Touch Recording. It flashes if the power is off for a timer recording, but there is no tape in the VCR. It flashes when all timer recordings are finished.

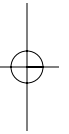
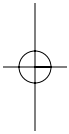

24 Front Panel

Remote Sensor

Receives a signal from your remote control so you can operate your VCR from a distance.

POWER Button

Press to turn the VCR power on and off.

AUDIO IN Jack

Connect a cable coming from the audio out jack of a camcorder, another VCR, or an audio source here. *Details are on page 38.*

VIDEO IN Jack

Connect a cable coming from the video out jack of a camcorder, another VCR, or an audio-visual source (laser disc player, video disc player, etc.) here. *Details are on page 38.*

VCR/TV Button

Press to select VCR or TV position.

● VCR Position

Use to watch a tape, to watch a program while recording it, or to watch a TV program (changing channels at the VCR). When the VCR light appears on the display panel, the VCR is in VCR position.

● TV Position

Use to watch TV (changing channels at the TV) or to watch one program while recording another. When the VCR light does not appear on the display panel, the VCR is in TV position.

F.FWD (Fast Forward) Button

When playback is stopped, press to fast forward the tape at high speed. During tape playback, press to fast forward the tape while the picture stays on-screen. *Details are on page*

STOP/EJECT Button

Press once to stop the tape. When playback is stopped, press to eject the tape.

PLAY Button

Press to play a tape. Press to release Slow, Search, or Still mode and return to playback. *Details are on page 42.*

REW(ind) Button

When playback is stopped, press to rewind the tape at high speed. During playback, press to rewind the tape while the picture stays on-screen. *Details are on page 42.*

CHANNEL (▼/▲) Buttons

Press to change channels at the VCR. Or, press to adjust the tracking of a tape during normal playback or slow motion playback. Also, press to remove vertical jitter in a Still picture.

REC(ord)/OTR Button

Press once to start a recording. Press repeatedly to start a One-Touch Recording. *Details are on page 29.*

PAUSE Button

While recording, press to pause the recording. Press again to resume recording. *Details are on page 27.* You can not pause a One-Touch Recording. During tape playback, press to freeze the picture. Press again to resume playback. *Details are on page 42.*

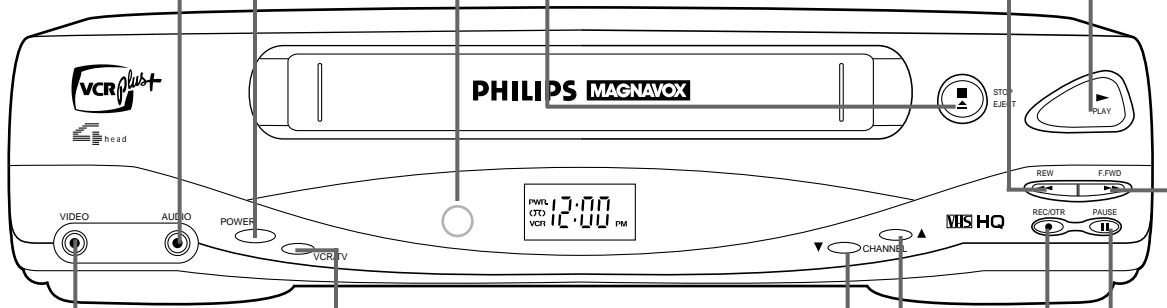

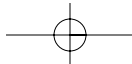

Rear Panel 25



ANT(enna) IN Jack
Connect your antenna or cable here. *Details are on pages six-10.*

AUDIO IN Jack
Connect a cable coming from the AUDIO OUT Jack of a camcorder, another VCR, or an audio source here. *Details are on page 38.*

AUDIO OUT Jack
Connect a cable going to the AUDIO IN Jack of a camcorder, another VCR, or an audio source here. *Details are on page 38.*

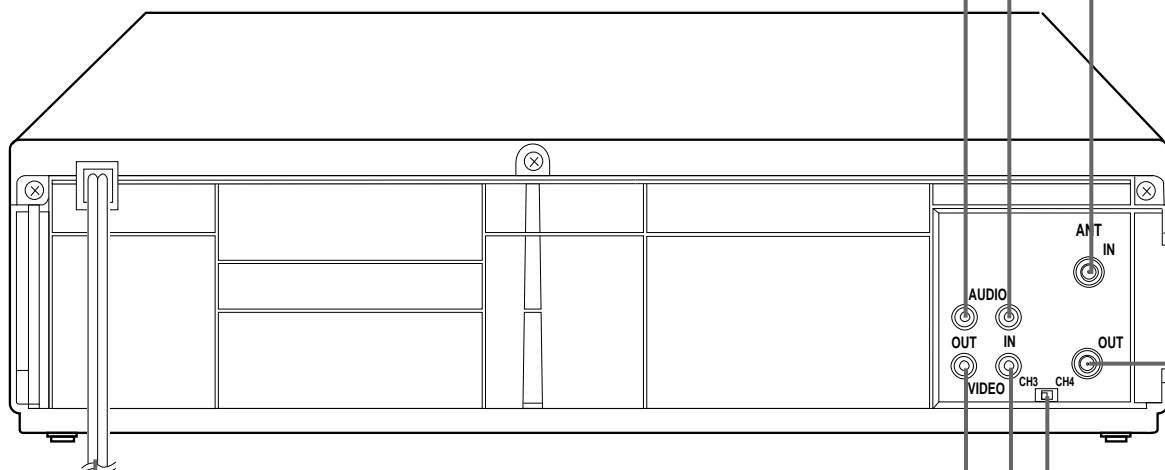

VIDEO OUT Jack
Connect a cable going to the VIDEO IN Jack of a camcorder, another VCR, or an audio-visual source (laser disc player, video disc player, etc.) here. *Details are on page 38.*

VIDEO IN Jack
Connect a cable coming from the VIDEO OUT Jack of a camcorder, another VCR, or an audio-visual source (laser disc player, video disc player, etc.) here. *Details are on page 38.*

CH3/CH4 Switch
Set to channel 3 or 4 to use your TV with your VCR. *Details are on pages six-nine.*

AC Power Cord
Connect to a standard AC outlet to supply power to the VCR.

OUT Jack
Use the supplied RF coaxial cable to connect this jack to the ANTENNA IN Jack on your TV, Cable Box, or Direct Broadcast System. *Details are on pages six-nine.*

26 Playing

Read and follow the steps below to play a tape.

1

Turn on the TV and set it to channel 3 or 4, whichever the CH3/CH4 switch on the back of the VCR is set to.

2

Insert a tape in the VCR. The PWR., VCR, and Cassette-Inside lights will appear on the display panel. If the tape's record tab has been removed, playback will start automatically.

3

If playback does not start automatically, press the PLAY/▲ button.

4

Press the STOP/▼ button on the remote control or the STOP/EJECT button on the VCR once to stop playback.

5

Press the REW(ind)/◀ button to rewind the tape.

6

When the tape stops, press the EJECT button on the remote control or the STOP/EJECT button on the VCR to remove the tape.

1

 Turn on the TV.

2

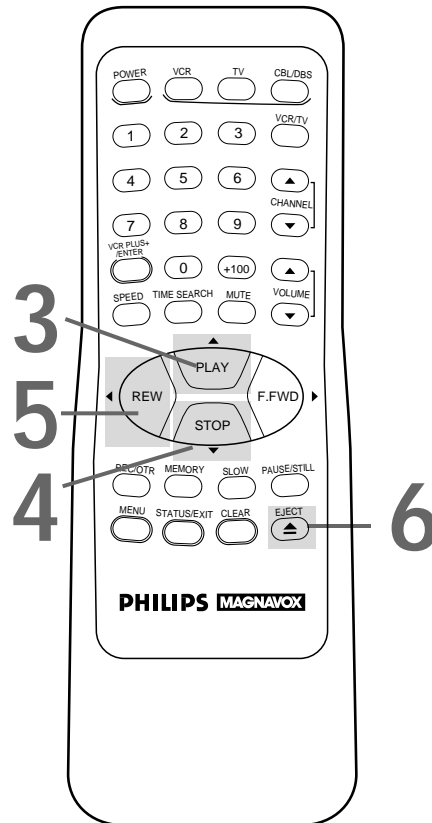
 Insert a tape in the VCR.

Helpful Hints

- If the tape you want to play is already in the VCR, make sure the VCR power is on and the VCR is in VCR position. (The VCR light will appear on the display panel. If it does not, press the VCR/TV button.) Press the VCR button, then press the PLAY/▲ button.
- Other playback options and features are on pages 39 - 43.

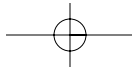

Recording 27

Read and follow the steps below to record a television program.

1

Turn on the TV and set it to channel 3 or 4, whichever the CH3/CH4 switch on the back of the VCR is set to.

2

Insert a tape with its record tab intact in the VCR.

3

Press the VCR button.

4

If the VCR light appears on the display panel, go to step 5. If the VCR light does not appear, press the VCR/TV button once.

5

Press the SPEED button until the desired tape speed appears briefly on-screen. (Details about tape speed are on page 32.)

6

Use the CHANNEL ▲/▼ buttons or the Number buttons to select the channel to be recorded.

7

Press the REC(ord)/OTR button once to start recording. The REC light will appear.

8

To pause the recording, press the PAUSE/STILL button once. The REC light will flash. To resume recording, press the REC(ord)/OTR button or press the PAUSE/STILL button again. The REC light will come on again.

9

To stop recording, press the STOP/▼ button.

1 Turn on the TV.

2 Insert a tape in the VCR.

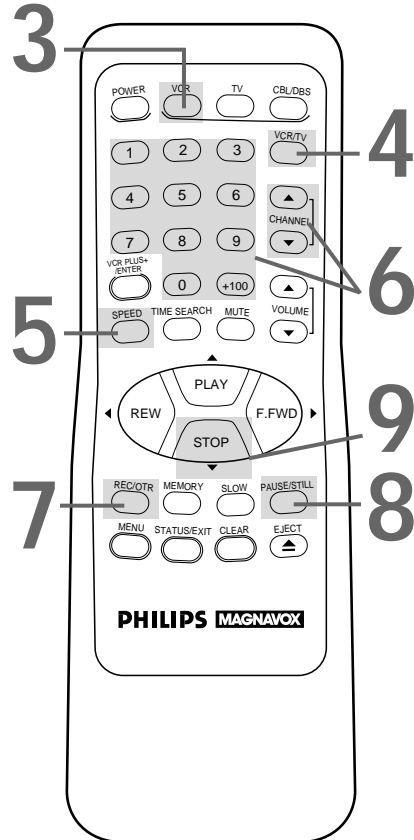

Helpful Hints

- If you press the REC(ord)/OTR button when there is not a tape in the VCR, NO CASSETTE will flash on-screen.
- If you press the REC(ord)/OTR button while a tape without a record tab is in the VCR, the VCR will eject the tape and PROTECTED CASSETTE CANNOT RECORD will flash on-screen.
- Other recording options are on pages 28 - 38.
- You can change the tape speed during a recording, but some distortion will appear on the tape.
- The VCR will record in a preset volume.

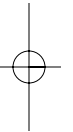
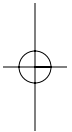

28 Recording One Channel/Watching Another

1

Start a recording. (See page 27.)

2

Press the VCR button.

3

Press the VCR/TV button to put the VCR in TV position. The VCR light will disappear from the VCR's display panel.

4

Press the TV button, then press the CHANNEL ▲/▼ or Number buttons to choose the channel you want to watch at the TV. (If the VCR remote control doesn't operate your TV, use the TV remote control to select the channel.)

5

To return to the channel being recorded, press the TV button, then use the Number buttons to select channel 03 or 04 at the TV (whichever channel the CH3/CH4 switch on the back of the VCR is set to). (If the VCR remote control doesn't operate your TV, use the TV remote control to select channel 03 or 04.)

6

Press the VCR button.

7

Press the VCR/TV button to put the VCR in VCR position. The VCR light will appear on the display panel. The channel being recorded will appear on-screen.

8

Press the STOP/▼ button to stop the recording.

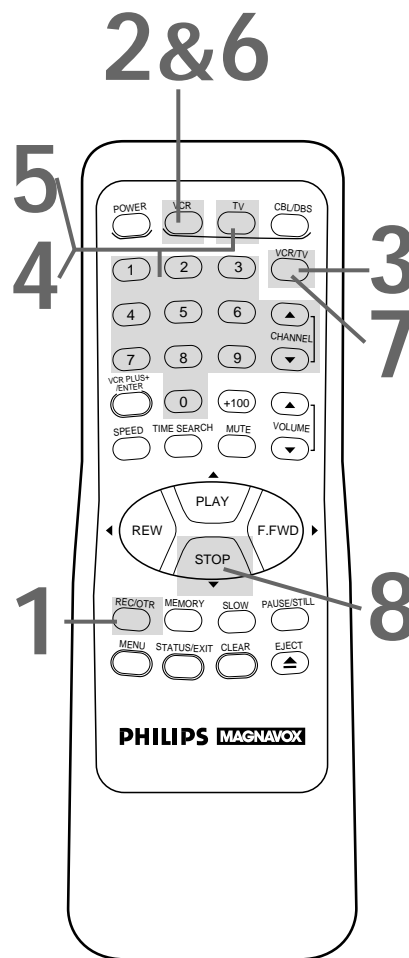

Helpful Hints

- If your VCR remote control does not operate your TV, see page 18 for details.
- If you use a Cable Box or Direct Broadcast System hookup, you may not be able to watch one channel while recording another. See pages eight-nine for details.

One-Touch Recording 29

The one touch recording (OTR) feature allows you to set an immediate timed recording 30 minutes to eight hours long. Before you begin:

- Set up the channels at the VCR.
- Select a recording speed (SP, LP, SLP) with the SPEED button.
- Put a tape in the VCR. Make sure the tape's record tab is intact and the tape is long enough to record the program(s).
- Place the VCR in VCR position. (The VCR light will appear on the display panel. If it does not, press the VCR/TV button once.)

1

Press the VCR button.

2

Press the CHANNEL ▲/▼ buttons or the Number buttons to select the channel you want to record.

3

Press the REC(ord)/OTR button repeatedly until the desired recording length (30 minutes to eight hours) appears on-screen. Recording will begin immediately. The REC light and the Timer light will appear on the display panel.

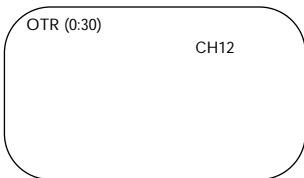

4

To stop an OTR before recording is finished, press the STOP/▼ button or the POWER button.

To cancel the OTR but continue recording, press the REC(ord)/OTR button repeatedly until REC appears in the upper left corner of the TV screen. (STATUS must be set to ON. See page 22 for details.) The REC light will remain on the display panel of the VCR, but the Timer light will disappear.

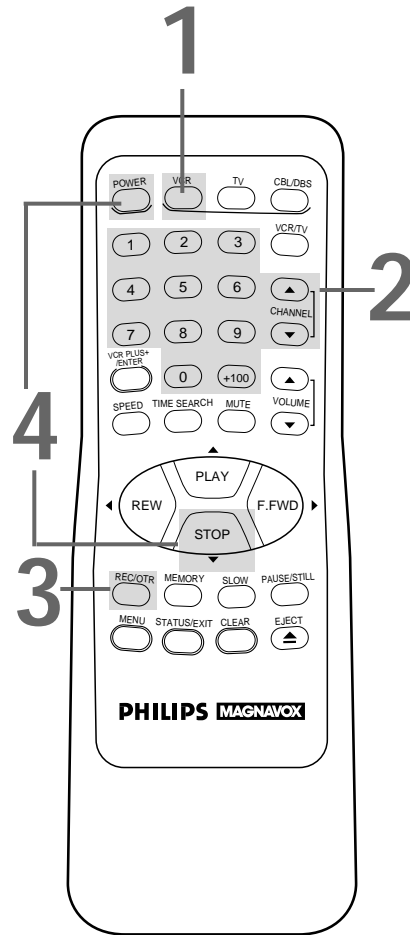

Helpful Hints

- To check the time remaining for an OTR after the OTR has been set, press the STATUS/EXIT button.
- To change the recording length while an OTR is in progress, press the REC(ord)/OTR button until the desired length appears on-screen.
- If you begin an OTR when another recording is paused, the OTR will begin.
- You can not pause an OTR.
- If the preset time for a timer recording comes up during an OTR, the OTR has priority. The timer recording will not take place.

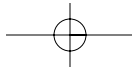

30 Timer Recording

Follow the steps below to program your VCR to record TV programs while you're away from home. The VCR will turn itself on, record, and turn itself off automatically. Before you begin:

- Set up the channels at the VCR.
- Set the clock.
- Put a tape in the VCR. Make sure the tape's record tab is intact and the tape is long enough to record the program(s).
- Put the VCR in VCR position. The VCR light will appear on the display panel. If it does not, press the VCR/TV button once.

Do each step within 60 seconds of the previous step.

1

Press the **VCR** button, then press the **MENU** button.

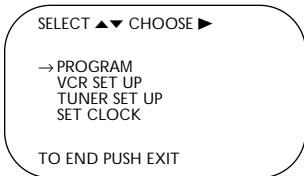

2

Press the **PLAY/▲** button or the **STOP/▼** button to select **PROGRAM**, then press the **F.FWD/▶** button.

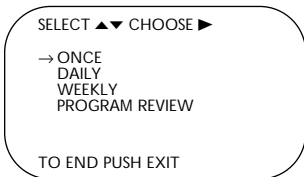

3

Press the **PLAY/▲** button or the **STOP/▼** button to select a **ONCE, DAILY, OR WEEKLY** recording. Then, press the **F.FWD/▶** button.

- **ONCE:** The VCR will record a TV program on any day you choose, up to 12 months away.
- **DAILY:** The VCR will record every day from Monday to Friday – starting at the same time and recording for the same length of time.
- **WEEKLY:** The VCR will record on the same day, at the same time, and for the same length of time every week.

Daily Recording (example)

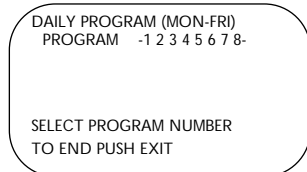

2-3

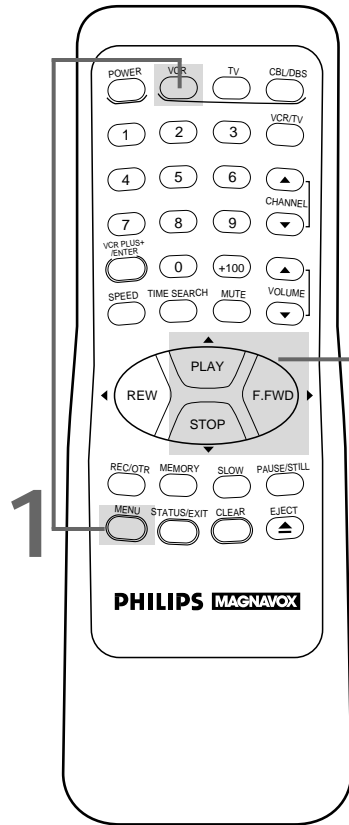

Helpful Hint

- If you need to make a correction while programming a timer recording, press the **CLEAR** button until the cursor is flashing on the item you want to change. Then enter the correct information.

Timer Recording (cont'd) 31

4

Use the Number buttons (1 - 8) to select a slot in which to store the timer recording. There are eight slots. Open slots will flash on-screen.

NOTE: If you enter a number for a slot that has already been used to store a timer recording, PREVIOUSLY SET PROGRAM will appear on-screen briefly. Information about the program in that slot will appear on-screen. If this happens, press the STATUS/EXIT button, then select another number.

5

Use the Number buttons to enter the channel you want to record.

- If you have a basic antenna or cable hookup (as shown on pages six-seven) enter the channel number of the TV program you want to record. (Enter a 0 before all single-digit channels.)
- If you are recording from line input, press 0, 0. AV REAR will appear on-screen.
- If you are using a Cable Box/DBS, enter the Cable Box/DBS output channel (03 or 04). Set the Cable Box/DBS to the channel you want to record. Leave the Cable Box/DBS on for the timer recording. See page eight for details.

ONE TIME PROGRAM
PROGRAM 1
CHANNEL --

TO CORRECT PUSH CLEAR
TO END PUSH EXIT

6

Press two Number buttons for the hour you want the recording to begin. Press two Number buttons for the minute you want the recording to begin. Press 1 for AM or 2 for PM. For example, for 9:30 PM, press 09, 30, 2.

ONE TIME PROGRAM
PROGRAM 1
CHANNEL 10
TIME ON --:--

TO CORRECT PUSH CLEAR
TO END PUSH EXIT

7

Follow the instructions in step 6 to enter the recording's stop time. (AM or PM will be set automatically.)

ONE TIME PROGRAM
PROGRAM 1
CHANNEL 10
TIME ON 09:30 PM
TIME OFF --:--

TO CORRECT PUSH CLEAR
TO END PUSH EXIT

Instructions continue on page 32.

4-7

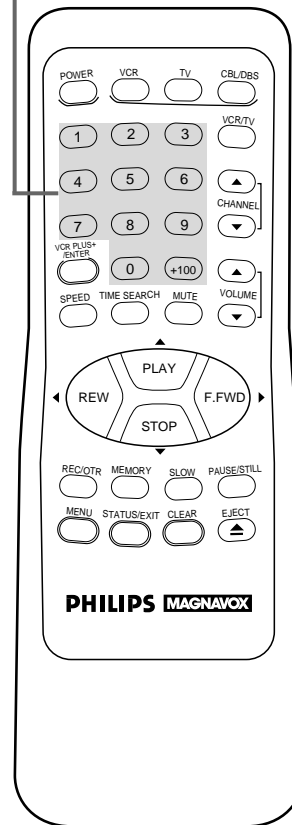

Helpful Hint

- Entries that do not match the VCR's clock or calendar will cause a question mark to appear on-screen.

32 Timer Recording (cont'd)

8

Press the Number 1 button to record in SP speed, the Number 2 button to record in LP speed, or the Number 3 button to record in SLP speed. (See the chart below.) You cannot use the SPEED button at this time.

```

ONE TIME PROGRAM
PROGRAM      1
CHANNEL     10
TIME ON     09:30 PM
TIME OFF    11:00 PM
REC SPEED   SLP
            SP=1 LP=2 SLP=3
TO CORRECT PUSH CLEAR
TO END PUSH EXIT
    
```

9

Press two Number buttons for the month and two Number buttons for the day you want to record the program. For example, for July 10, 1998, press 07, 10. The day of the week and the year will appear automatically (you cannot program the VCR to record more than one year in advance).

```

ONE TIME PROGRAM
PROGRAM      1
CHANNEL     10
TIME ON     09:30 PM
TIME OFF    11:00 PM
REC SPEED   SLP
START DATE  07/10/98
            FRI.
TO CORRECT PUSH CLEAR
TO END PUSH EXIT
    
```

10

Press the STATUS/EXIT button. PROGRAM WAS COMPLETED / PLEASE TURN OFF VCR FOR TIMER RECORDING will appear on-screen briefly. (If PROGRAM NOT COMPLETED appears, try again from step 1.)

11

Turn off the VCR power. The Timer light will appear on the display panel.

If the timer recording will take place several hours or days from now, you may use the VCR until time for the recording. Turn off the VCR a few minutes before the recording starts. If you forget to turn off the VCR, PLEASE TURN OFF VCR FOR TIMER RECORDING flashes on your TV screen two minutes before a timer recording starts. Press the CLEAR button to remove the message.

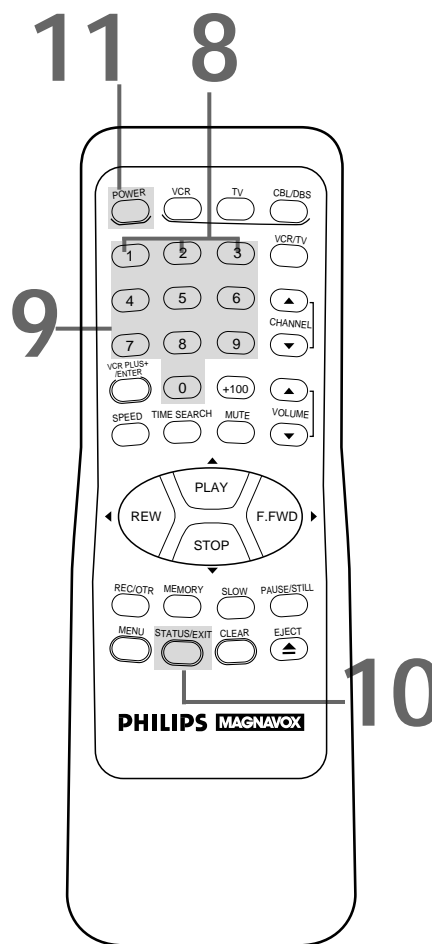

The VCR must be off for a timer recording. Put a tape in the VCR.

Tape Speeds	Tape Speed Type	Maximum Record/Playback Time		
		T160	T120	T60
This chart shows the recording/playback time for three types of video cassettes (T160, T120, and T60). There are three playback speeds: SP, LP, and SLP. When recording, you can change the tape speed using the SPEED button.	SP (Standard Play)	2 hrs. 40 mins.	2 hrs.	1 hr.
	LP (Long Play)	5 hrs. 20 mins.	4 hrs.	2 hrs.
	SLP (Super Long Play)	8 hrs.	6 hrs.	3 hrs.

Timer Recording (cont'd) 33

Checking or Cancelling Timer Recordings

1

With the VCR on and in VCR position (the VCR light will appear on the display panel), **press the VCR button, then press the MENU button.**

2

Press the **PLAY/▲** button or the **STOP/▼** button to select **PROGRAM**, then press the **F.FWD/▶** button.

3

Press the **PLAY/▲** button or the **STOP/▼** button to select **PROGRAM REVIEW**, then press the **F.FWD/▶** button. The timer recording information for the program in the lowest numbered slot will appear on-screen. If no timer recordings are set, nothing will happen when you press the **F.FWD/▶** button.

4

Press the **F.FWD/▶** button repeatedly to review all programmed timer recordings. If you don't press the **F.FWD/▶** button within 10 seconds, the VCR will automatically display information about the next programmed timer recording. This will continue until all timer recordings have been displayed. Then the menu will disappear.

5

To cancel the timer recording displayed, press the **CLEAR** button. Either the display will disappear or information about other timer recordings will appear. If you do not press any other buttons, the display will disappear after all timer recordings have been displayed.

6

Repeat steps 1 - 4 to make sure you have cleared the correct timer recording.

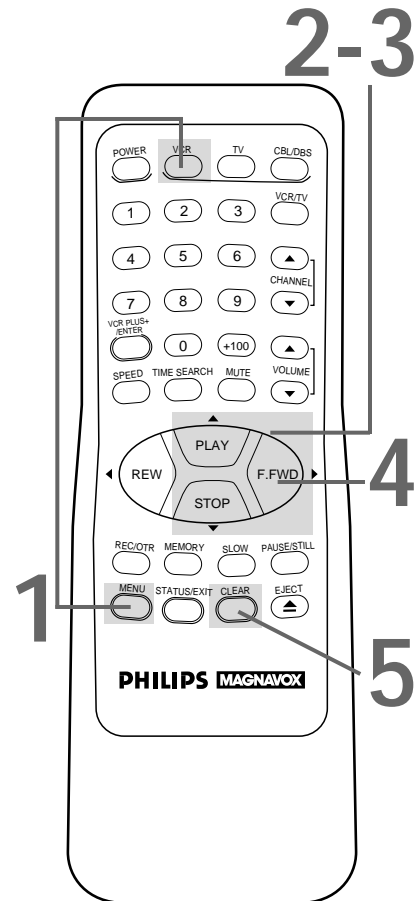

Helpful Hints

- *CLASH* may flash on-screen when you finish setting a timer recording. This means that the timer recording you just programmed and another timer recording overlap. The current timer recording will not take place. You may choose to cancel the overlapping timer recording.
- If the preset time for a timer recording comes up during a One-Touch Recording, the OTR has priority.
- To stop a started timer recording, press the STOP/EJECT button on the VCR.
- If the power fails for more than one minute, programmed timer recordings will be lost. Reset the clock before resetting the timer recordings.

See page 44 for more hints.

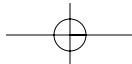

Setting Up the VCR Plus+ Programming System (cont'd) 35

2

Now, compare the channel numbers you have written in the VCR PLUS+ CH. and CABLE/TV CH. columns. For stations whose VCR Plus+ and Cable/TV channels do not match, you must tell the VCR the VCR Plus+ and Cable/TV channel numbers by following steps 3 - 7. Make each entry within 60 seconds of the previous entry.

3

Press the VCR button, then press the MENU button.

4

Press the PLAY/▲ button or the STOP/▼ button to select VCR SET UP, then press the F.FWD/▶ button.

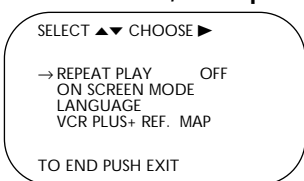

5

Press the PLAY/▲ button or the STOP/▼ button to select VCR PLUS+ REF. MAP, then press the F.FWD/▶ button.

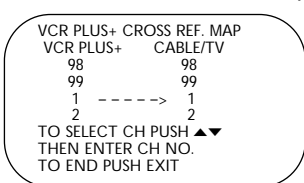

6

Look at the lists you filled in on page 34. For stations whose VCR Plus+ and Cable/TV channels do not match, press the PLAY/▲ button or the STOP/▼ button until the arrow is beside the VCR Plus+ channel you need. Then, press the Number buttons to enter the corresponding Cable/TV channel from your list. (Enter a "0" before single-digit channels.) Enter all the stations on your list.

Note: If you are using a Cable Box/DBS, the Cable/TV channel will be 03 or 04 (the Cable Box/DBS output channel) for every VCR Plus+ channel. You must set the Cable Box/DBS to the channel you want to record; leave the Cable Box/DBS on for the timer recording.

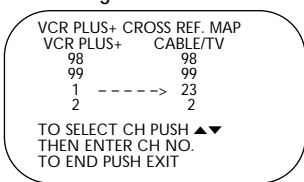

7

Press the STATUS/EXIT button.

2

Examine the lists on page 34.

4-5

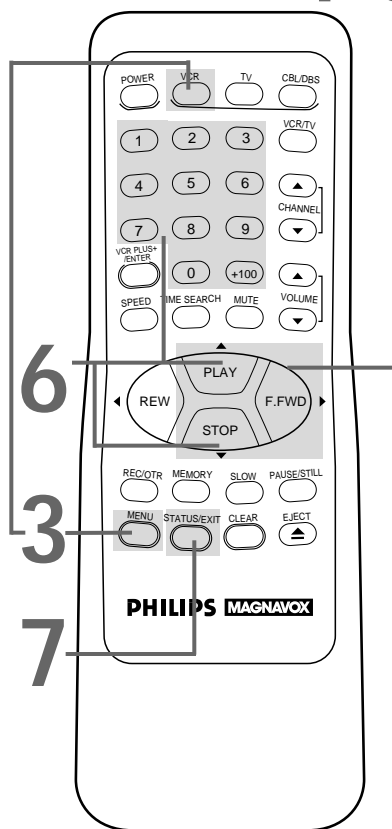

Helpful Hints

- To erase a Cable/TV channel number, repeat steps 3-5 on this page. Then, press the PLAY/▲ button or the STOP/▼ button to select it. Press the CLEAR button, then press the STATUS/EXIT button.
- To select line input for the Cable/TV channel, press 0,0. AUX will appear on-screen.
- When you receive the VCR, all the VCR Plus+ channel numbers and Cable/TV channel numbers are the same.

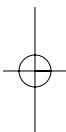

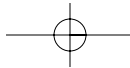

36 Timer Recording With the VCR Plus+ Programming System

Follow these steps to set a timer recording with the PlusCode programming numbers in your TV guide. Before you begin:

- Set up the channels at the VCR (page 12).
- Set up the VCR Plus+ and Cable/TV channel numbers (pages 34 - 35).
- Set the clock (page 15).
- Put a tape in the VCR.
- Turn on the VCR power. The VCR light should appear on the display panel. If it does not, press the VCR/TV button once.

Do each step within 60 seconds of the previous step.

1

Press the VCR button.

2

Press the VCR PLUS+ /ENTER button.

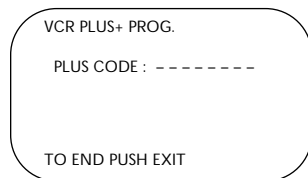

3

Press the Number buttons to enter the PlusCode programming number of the program you wish to record. Then, press the VCR PLUS+ /ENTER button.

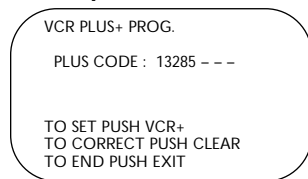

4

Press the PLAY/▲ button or the STOP/▼ button to select a **ONCE**, **DAILY**, OR **WEEKLY** recording. Then, press the F.FWD/▶ button.

- **ONCE:** The VCR will record a TV program on any day you choose, up to 12 months away.
- **DAILY:** The VCR will record every day from Monday to Friday – starting at the same time and recording for the same length of time.
- **WEEKLY:** The VCR will record on the same day, at the same time, and for the same length of time every week.

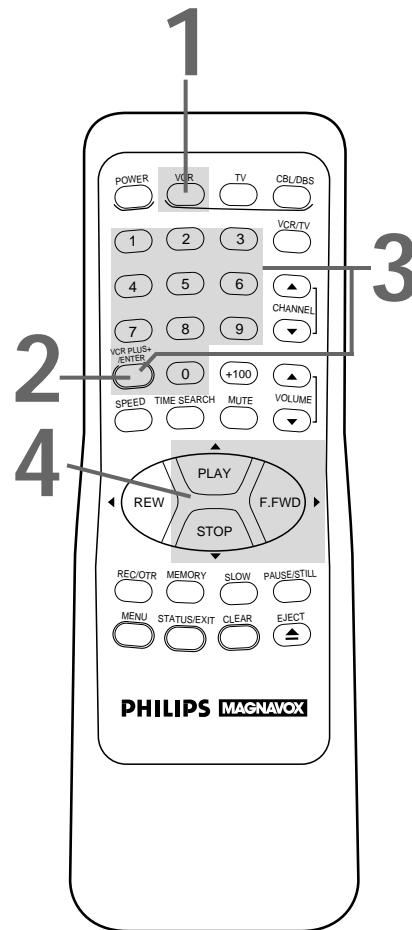
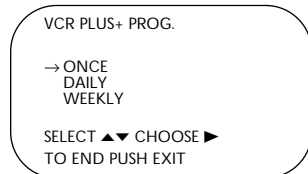

Helpful Hints

- **CODE ERROR** may flash on-screen after step 3 if you enter an incorrect number (for example, one that is too short). The previous screen will appear. Enter the correct PlusCode programming number.
- If the **VCR PLUS+ CROSS REF. MAP** reappears after step 3, the VCR PLUS + channel number for the recording you entered was higher than 99. In this case, enter the correct CABLE/TV channel in the map. Then, press the MENU button and continue from step 4.
- If **CLASH** flashes on-screen at step 3, the timer recording you just programmed and another timer recording overlap. The current timer recording will not occur.

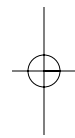
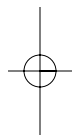

Timer Recording With the VCR Plus+ Programming System (cont'd) 37

5

Press the Number 1 button to record in SP speed, the Number 2 button to record in LP speed, or the Number 3 button to record in SLP speed. Your selection will appear beside REC SPEED on-screen; SP=1 LP=2 SLP=3 will continue to flash. For details about tape speed, see pages 32 and 46. You cannot use the SPEED button at this time.

```

ONE TIME PROGRAM
PROGRAM      1
CHANNEL     09
TIME ON     10:30 PM
TIME OFF    11:30 PM
REC SPEED   SLP
           SP=1 LP=2 SLP=3
START DATE  10/10/98
           SAT.
TO END PUSH EXIT
  
```

6

Press the **STATUS/EXIT** button. PROGRAM WAS COMPLETED / PLEASE TURN OFF VCR FOR TIMER RECORDING should appear on-screen briefly.

7

Press the **POWER** button to turn off the VCR power. The Timer light will appear. The Timer light will flash if there is not a tape in the VCR.

If the timer recording will take place several hours or days from now, you may use the VCR until time for the recording. Just turn off the VCR a few minutes before the recording starts. If you forget to turn off the VCR, PLEASE TURN OFF VCR FOR TIMER RECORDING flashes on your TV screen two minutes before a timer recording starts. Remove the message by pressing the CLEAR button.

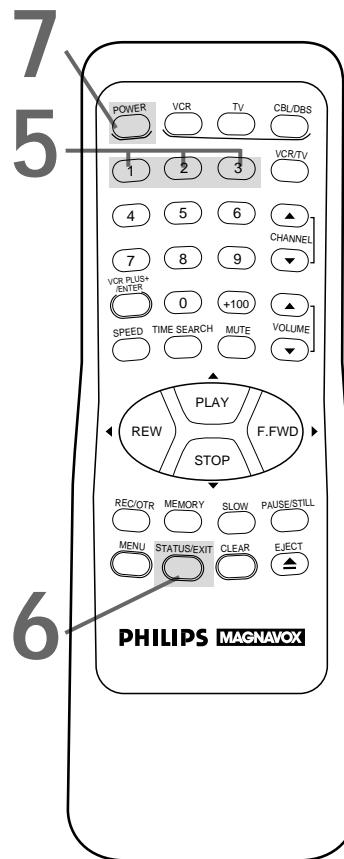

The VCR must be off for a timer recording to take place! Make sure there is a tape in the VCR.

Helpful Hints

- If the time for a timer recording comes up during a One-Touch Recording, the OTR has priority.
- To stop a started timer recording, press the STOP/EJECT button on the VCR.
- If the power fails for more than one minute, programmed timer recordings may be lost. Reset the clock before resetting the timer recordings.
- If you are using a Cable Box, timer recordings are programmed differently. See page eight for details. See page 44 for more hints.

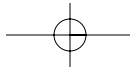

38 Rerecording (Tape Duplication)

1. Audio cable from AUDIO OUT Jack of VCR 1 to AUDIO IN Jack of VCR 2

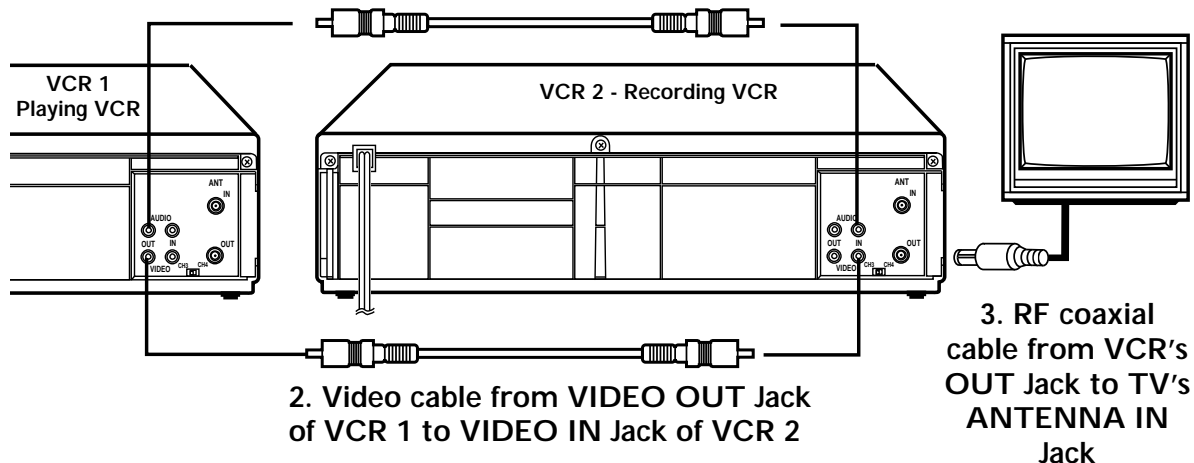

2. Video cable from VIDEO OUT Jack of VCR 1 to VIDEO IN Jack of VCR 2

3. RF coaxial cable from VCR's ANTENNA OUT Jack to TV's ANTENNA IN Jack

- Audio and Video cables are not supplied.

1

Make the connections shown above.

2

VCR 1 will play your tape. Put a prerecorded tape in VCR 1.

3

VCR 2 will record your tape. Insert a blank tape in VCR 2. The VCR must be in VCR position. (The VCR light will appear on the display panel. If it does not, press the VCR/TV button once.)

4

Turn on the TV and set it to channel 03 or 04, whichever channel the CH3/CH4 switch on VCR 2 is set to.

5

Point the remote control at VCR 2. Press Number buttons 0, 0, 1 or 0, 0, 2. (See Helpful Hints at right.)

6

Use the SPEED button to select SP, LP, or SLP at VCR 2.

7

Press the PLAY button on VCR 1 and the REC(ord)/OTR button on VCR 2 at the same time.

To stop recording, press the STOP/EJECT button on VCR 1, then press the STOP/EJECT button on VCR 2.

Helpful Hints

- If you use the AUDIO and VIDEO IN Jacks on the back of VCR 2, press Number buttons 0, 0, 1. AV REAR will appear on-screen.
- If you use the AUDIO and VIDEO IN Jacks on the front of VCR 2, press Number buttons 0, 0, 2. AV FRONT will appear on-screen.
- Unauthorized recording of copyrighted television programs, video tapes, or other materials may infringe on the rights of copyright owners and violate copyright laws.
- These instructions show you how to copy tapes using two VCRs like yours. Different VCRs may operate differently.

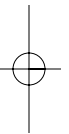
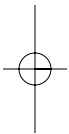

Repeat Play 39

Follow the steps below to make the VCR play a tape over and over.

1

Press the VCR button.

2

Press the MENU button.

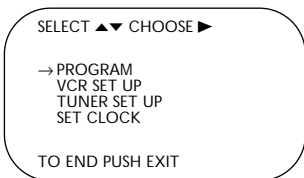

3

Press the PLAY/▲ button or the STOP/▼ button to select VCR SET UP, then press the F.FWD▶ button.

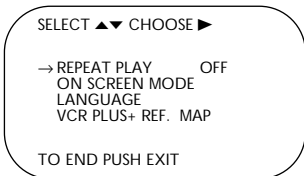

4

Press the PLAY/▲ button or the STOP/▼ button to select REPEAT PLAY.

5

Press the F.FWD▶ button so that ON appears beside REPEAT PLAY.

6

Press the STATUS/EXIT button. Now, when a tape has finished playing, the VCR will rewind it and start playback again.

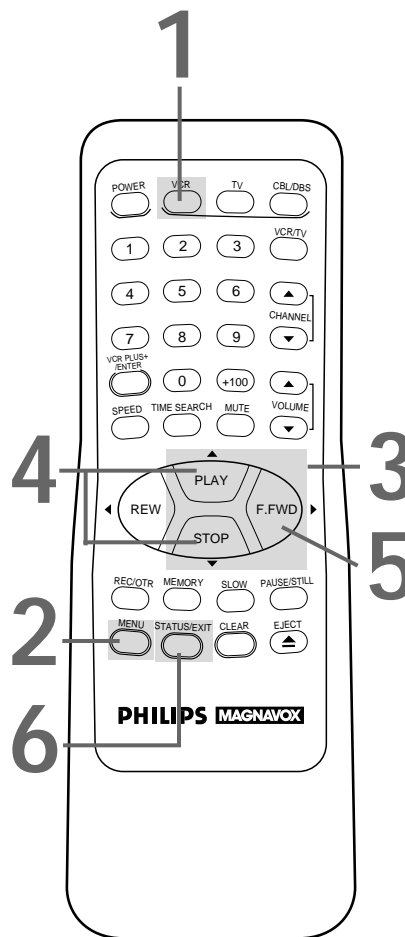

Helpful Hints

- To cancel Repeat Play, follow steps 1 - 4 above. At step 5, press the F.FWD▶ button so that OFF appears beside REPEAT PLAY. Press the STATUS/EXIT button.
- The real-time counter memory does not function during Repeat Play.

40 Time Search

Follow the steps below to program the VCR to search forward or backward on a tape a specific length of time. There must be a tape in the VCR.

1

Press the VCR button.

2

Press the TIME SEARCH button.

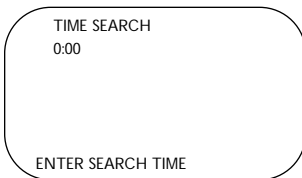

3

Within 10 seconds, use the Number buttons to enter the desired length of time you want to skip forward or backward. For example, for 1 hour, 25 minutes, press Number buttons 1, 2, 5. Or, for five minutes, press Number buttons 0, 0, 5.

4

Within 10 seconds, press the F.FWD/▶ button or the REW(ind)/◀ button. The VCR will skip over the specified length of time, then begin playback.

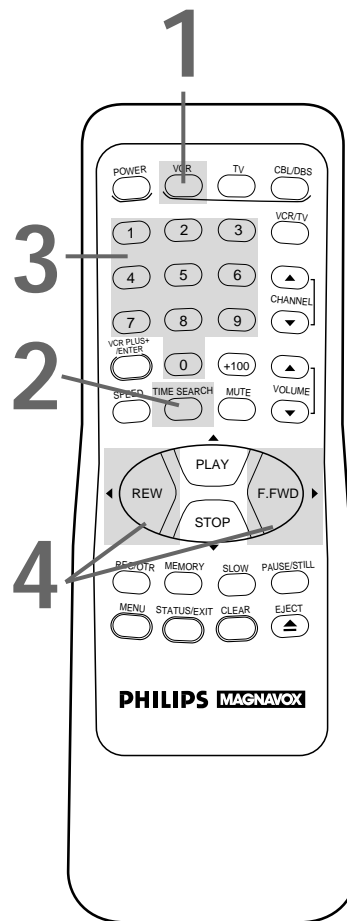

Helpful Hints

- If you want to search for more than 59 minutes, you must enter the length of time in hours and minutes. For example, to search forward 70 minutes, press 1,1,0 at step 3.
- You can not do a Time Search while recording.
- To remove the Time Search display, press the TIME SEARCH button again.
- To cancel a Time Search that is in progress, press the STOP/▼ button.

Real-Time Counter Memory 41

Follow the steps below to reset the real-time counter to zero at a tape location you want to refer to later.

1

Play, fast forward, or rewind a tape to the location that you would like to refer to later. Press the **STOP/▼** button to stop the tape.

2

Press the **STATUS/EXIT** button to see the status display.

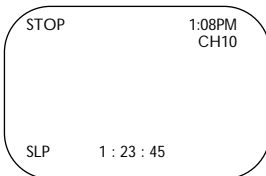

3

While the status display is on-screen, press the **CLEAR** button to reset the real-time counter to zero.

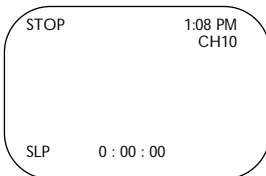

4

While the real-time counter is on-screen, press the **MEM-ORY** button so that **M** appears beside the counter.

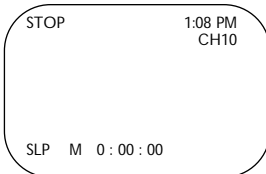

5

To go to a tape location where the real-time counter was reset to zero, press the **REW(ind)/◀** button or the **F.FWD/▶** button when playback is stopped.

When the tape reaches the point at which the counter was set to zero, the tape will stop.

Press the **PLAY/▲** button to watch the tape.

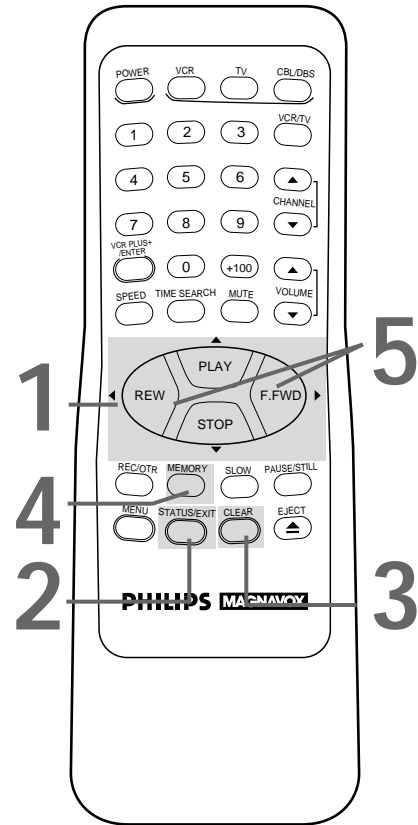

Helpful Hints

- The **MEMORY** button does not function if **REPEAT PLAY** is set to **ON**. Details are on page 39.
- To erase a real-time counter memory, press the **MEMORY** button until the **M** disappears from the screen.
- You may only set the real-time counter to zero at one location at a time. If you try to set the real-time counter to zero at a second location, the previous real-time counter to zero setting will be erased.

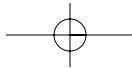

42 Special Effects Playback

Forward and Reverse Searching (SP/LP/SLP)

1

During tape playback, press and release the **F.FWD/▶** button or the **REW(ind)/◀** button. A fast forward or reverse picture search will begin.

2

To return to playback, press the **PLAY/▲** button.

Super High Speed Searching (LP/SLP)

1

During tape playback, press the **F.FWD/▶** button or the **REW (ind)/◀** button, then press again. The VCR will now search in super high speed.

2

To return to normal playback, press the **PLAY/▲** button.

Viewing a Still Picture

1

During tape playback, press the **PAUSE/STILL** button. A still picture will appear on-screen.

2

To release the still picture and return to playback, press the **PLAY/▲** button or press the **PAUSE/STILL** button again.

Viewing a Slow Motion Picture

1

During tape playback, press the **SLOW** button. The tape will play in slow motion.

2

To return to normal playback, press the **PLAY/▲** button or press the **SLOW** button again.

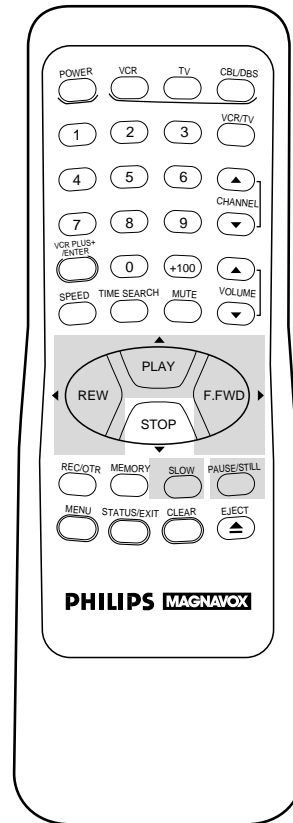

Helpful Hints

- *Slow and Still modes will automatically switch to Stop mode after five minutes to protect the VCR and the tape from damage.*
- *SP/LP/SLP means this feature will work with tapes recorded in Standard Play, Long Play, or Super Long Play.*
- *LP/SLP means this feature will work with tapes recorded in Long Play or Super Long Play. For details about tape speed, see pages 32 and 46.*

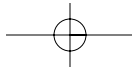

Automatic Operation Features 43

The following playback features will always operate.

Automatic Playback

When you put a tape in the VCR, the power will come on automatically. If the tape's record tab is missing, playback will begin. If a timer recording is set, the power will not come on automatically when you insert a tape with the record tab intact. If a timer recording is set and the VCR power is off, the VCR will eject the tape if the record tab is missing.

Automatic Rewind, Eject, Off

When a tape is played, fast forwarded, or recorded to its end, the VCR will rewind the tape, stop, eject the tape, then turn itself off. If the real-time counter memory is set, the VCR will only rewind to the point at which the counter is set to zero, then stop. The VCR will not eject the tape automatically or shut itself off.

Tape Eject

A tape can be ejected with the VCR power on or off (but the VCR must be plugged in). If a timer recording is set, a tape can only be ejected with the power on. Make sure you insert a tape and turn off the VCR power for the timer recording.

Automatic Tracking Adjustment

The VCR adjusts tracking automatically to give you the best possible picture quality. With some recordings, however, you may get a better picture using the manual tracking controls (see below).

Manual Tracking

To manually adjust the tracking during playback and slow motion playback, press the CHANNEL ▲/▼ buttons **on the VCR**. (The CHANNEL ▲/▼ buttons on the remote control will not adjust tracking.)

Tracking will return to Automatic Tracking Adjustment when you press the STOP/▼ button or insert a tape.

You cannot manually adjust the tracking of a Still picture. However, you may press the CHANNEL ▲/▼ buttons on the VCR to remove vertical jitter in a Still picture.

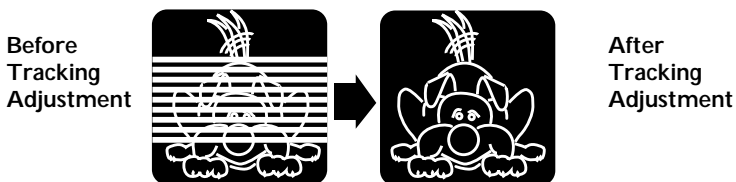

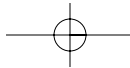

44 Helpful Hints

If you are having problems with your product, check this list of problems and possible solutions before requesting service. You may be able to solve the problem yourself.

If you need to call a customer service representative, please know the model number and serial number of your product before you call. This information is displayed on the back of the product. Also, please take a moment to identify the problem you are having, and be prepared to explain this to the representative. If you believe the representative will need to help you with operations, please stay near the product. Our representatives will be happy to assist you.

No power

- Make sure the power plug is completely connected to an AC (alternating current) outlet.
- Make sure the power is turned on.

Power Failure

- Timer recordings and the clock setting may be lost if the power fails for more than one minute. See page 15 to reset your clock. See pages 30 - 37 to reprogram your timer recordings.

A TV program cannot be recorded.

- Check the connections between the VCR, TV, antenna/cable, and Cable Box/Direct Broadcast System (if applicable) (pages six - 10).
- Make sure the tape has a record tab (page five).
- Check the TV/VCR position (page 24).
- Check the CH3/CH4 switch (pages six - nine).

The VCR will not perform a timer recording.

- Make sure the recording start and stop times are set correctly (pages 30 - 37).
- Make sure a tape is in the VCR and the tape has a record tab (page five). If, after programming a timer recording, you turn off the VCR power without putting a tape in the VCR, the Timer light will blink.
- If the record tab on a tape is missing, the VCR will eject the tape. The Timer light will blink.
- Make sure the VCR power is off.
- Make sure the clock is set (page 15).
- The VCR may not perform or continue a timer recording if a power interruption of more than one minute occurs.
- If you have a Cable Box/Direct Broadcast System, timer recordings are programmed differently. (See page eight for details.)
- Finish programming a timer recording at least five minutes before the recording is set to begin.
- 12 p.m. is noon; 12 a.m. is midnight.

There is no playback picture or the playback picture is noisy or contains streaks.

- Make sure the TV is on the same channel as the VCR's CH3/CH4 switch.
- Make sure the VCR is in VCR position. (The VCR light will appear on the display panel.)
- Make sure channel 03 or 04 is properly adjusted at the TV.
- Adjust the tracking (page 43).

The VCR cannot be controlled with the remote control.

- Press the VCR button, then try the other VCR feature buttons.
- Make sure the VCR light appears on the display panel. If it does not, press the VCR/TV button once.
- Aim the remote control directly at the VCR's remote sensor (page 24).
- Remove all obstacles between the remote control and the VCR.
- Inspect and/or replace the batteries in the remote control (page five).

The Number buttons won't work for channels above 69.

- Select CABLE TV at the TUNER SET UP menu (page 12), then let the VCR set up the channels.

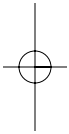

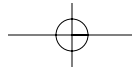

Helpful Hints (cont'd) 45

.....
TV programs cannot be watched normally.

- Put the VCR in TV position. (Press the VCR/TV button so that the VCR light disappears from the display panel. For details see page 24.)
- Check the connections between the VCR, TV, antenna/cable, and Cable Box/Direct Broadcast System (if applicable). (See pages six - 10 for details.)

Tape cannot be inserted.

- Insert the tape, window side up, with the record tab facing you.
- Make sure a tape isn't already in the VCR by pressing the STOP/EJECT button on the VCR.
- Gently push on the center of the tape when putting it in the VCR. Never force the tape into the VCR.
- If a timer recording is programmed and the VCR power is off, you can not insert a tape without a record tab.

Tape cannot be removed.

- Make sure the power plug is completely connected to a power outlet.
- You have set a timer recording. Turn the VCR power on, then eject the tape. Be sure to insert a tape and turn off the power for your timer recording.

VCR ejects the tape when the REC(ord)/OTR button is pressed or when the VCR power is turned off to set a timer recording.

- Make sure the tape has a record tab (page five).

Channels above 13 cannot be received.

- Select CABLE TV at the TUNER SET UP menu (page 12), then let the VCR set up the channels.

Poor reception

- You may need to tune your TV again.

The motor (cylinder) rotates even when the VCR is in Stop mode.

- To enable the quick play mechanism, the cylinder will rotate for about five minutes. This is normal.

Direct Broadcast System Hookups

- Watching one TV channel while recording another may not be possible if you have a DBS hookup. You may have to set your TV to channel 03 or 04, then make your channel selections at the DBS.
- With many DBS hookups, if you use accessory audio and video cables to connect your VCR to your TV, you will have to put your VCR in Line Input mode (channel 001 or 002).

Line Input mode

- If you accidentally enter Line Input mode (AV FRONT or AV REAR will appear on your TV screen briefly), press the CHANNEL ▲/▼ buttons or use the Number buttons to select another channel.

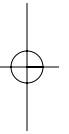
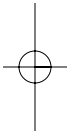

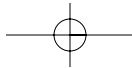

46 Glossary

AUDIO IN/OUT Jacks: jacks located on the front and back of the VCR which are used to record audio from another source (IN) or to send audio to another source (OUT).

Automatic Channel Setup: process in which the VCR memorizes all available channels. Then, when you press the CHANNEL ▲/▼ buttons, you only scan through channels you receive.

Bands: settings that allow you to tune channels.

- **Antenna** – VHF (very high frequency; channels 2 - 13) and UHF (ultra high frequency; channels 14 - 69).
- **Cable** – all standard channels can be received without a Cable Box.

Cable Box Output Channel: 03 or 04.

Dubbing: copying a tape using a second VCR.

Frame: a still picture.

HQ: high quality; a feature in the VCR circuitry which provides enhanced picture detail.

Line Input: The channel to which you set your VCR during dubbing. If you use the AUDIO and VIDEO IN jacks on the front of the VCR, select channel 002 (AV FRONT). If you use the AUDIO and VIDEO IN jacks on the back of the VCR, select 001 (AV REAR).

If you accidentally enter Line Input mode, press the CHANNEL ▲/▼ buttons or use the Number buttons to select another channel.

OTR: One-Touch Recording; a timed recording that starts immediately and records for 30 minutes to eight hours.

Remote Control: the small electronic unit that came with your VCR; allows you to operate your VCR from a distance. You may be able to operate your TV, Cable Box, or Direct Broadcast System with the remote control.

RF coaxial cable: The cable supplied with your VCR. Use it to connect your VCR to your TV (or Cable Box or DBS). The supplied cable is a snap-on type. However, you may use a screw-on type if you prefer.

Special Effects: forward and reverse searching; a still picture; slow motion playback.

Tape Speeds: how fast the tape travels during a recording or playback.

- **SP** (standard play) – fastest tape speed (recording time for a T120 tape is approximately two hours); best picture quality.
- **LP** (long play) – average tape speed (recording time for a T120 tape is approximately four hours).
- **SLP** (super long play) – slowest tape speed (recording time for a T120 tape is approximately six hours).

VCR: video cassette recorder.

VIDEO IN/OUT Jacks: jacks located on the front and back of the VCR which are used to record video from another source (IN) or to send video to another source (OUT).

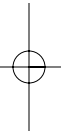
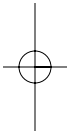

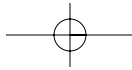

Specifications 47

Video Heads

Four heads

Video Signal

EIA standards; NTSC color

Antenna

VHF/UHF – 75 ohm external antenna terminal

VHF Output Signal

Channel 03 or 04 (switchable)

75 ohms unbalanced

Power Requirement

120V AC; 60Hz

Power Consumption

16W

Operating Temperature

41°F (5°C) to 104°F (40°C)

Relative Humidity

10% to 80%

Weight

5.51 lbs. (2.5 kg.)

Dimensions

14-3/16" (W) x 3-1/16" (H) x 10" (D)

(360 mm x 92mm x 230mm)

Tuner Broadcast Channels

VHF 2-13, UHF 14-69

Cable TV Channels

2 – 13

Midband: A – 1

Superband: J – W

Hyperband: A-5 – A-1

Special Channel: 5A

Ultraband: 37 – 94, 100 – 125

NOTE: Designs and specifications are subject to change without notice.

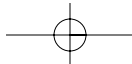

48 Limited Warranty

VIDEO CASSETTE RECORDER

90 Days Free Labor/One Year Parts Exchange. This product must be carried in for repair.

WHO IS COVERED?

You must have proof of purchase to receive warranty service. A sales receipt or other document showing that you purchased the product is considered proof of purchase.

WHAT IS COVERED?

Warranty coverage begins the day you buy your product. For 90 days thereafter, all parts will be repaired or replaced, and labor is free. From 90 days to one year from the day of purchase, all parts will be repaired or replaced, but you pay for all labor charges. After one year from the day of purchase, you pay for the replacement or repair of all parts, and for all labor charges.

All parts, including repaired and replaced parts, are covered only for the original warranty period. When the warranty on the product expires, the warranty on all replaced and repaired parts also expires.

WHAT IS EXCLUDED?

Your warranty does not cover:

- labor charges for installation or setup of the product, adjustment of customer controls on the product, and installation or repair of antenna systems outside of the product.
- product repair and/or part replacement because of misuse, accident, unauthorized repair or other cause not within the control of Philips Consumer Electronics Company.
- reception problems caused by signal conditions or cable or antenna systems outside the unit.
- a product that requires modification or adaptation to enable it to operate in any country other than the country for which it was designed, manufactured, approved and/or authorized, or repair of products damaged by these modifications.
- incidental or consequential damages resulting from the product. (Some states do not allow the exclusion of incidental or consequential damages, so the above exclusion may not apply to you. This includes, but is not limited to, prerecorded material, whether copyrighted or not copyrighted.)
- damage caused by the use of non-VHS tapes or tapes that have not been tested and labeled for use in two, four, six, and eight hour VHS recorders.
- a product that is used for commercial or institutional purposes (including but not limited to rental purposes).

WHERE IS SERVICE AVAILABLE?

Warranty service is available in all countries where the product is officially distributed by Philips Consumer Electronics Company. In countries where Philips Consumer Electronics Company does not distribute the product, the local Philips service organiza-

tion will attempt to provide service (although there may be a delay if the appropriate spare parts and technical manual(s) are not readily available).

MAKE SURE YOU KEEP...

Please keep your sales receipt or other document showing proof of purchase. Attach it to this owner's manual and keep both nearby. Also keep the original box and packing material in case you need to return your product.

BEFORE REQUESTING SERVICE...

Please check your owner's manual before requesting service. Adjustments of the controls discussed there may save you a service call.

TO GET WARRANTY SERVICE IN U.S.A., PUERTO RICO OR U.S. VIRGIN ISLANDS...

Take the product to a Philips factory service center (see enclosed list) or authorized service center for repair. When the product has been repaired, you must pick up the unit at the center. Centers may keep defective parts.

(In U.S.A., Puerto Rico and U.S. Virgin Islands, all implied warranties, including implied warranties of merchantability and fitness for a particular purpose, are limited in duration to the duration of this express warranty. Because some states do not allow limitations on how long an implied warranty may last, this limitation may not apply to you.)

TO GET WARRANTY SERVICE IN CANADA...

Please contact Philips at:

1-800-661-6162 (French Speaking)

1-800-363-7278 (English Speaking)

(In Canada, this warranty is given in lieu of all other warranties. No other warranties are expressed or implied, including any implied warranties of merchantability or fitness for a particular purpose. Philips is not liable under any circumstances for any direct, indirect, special, incidental, or consequential damages, howsoever incurred, even if notified of the possibility of such damages.)

REMEMBER...

Please record below the model and serial numbers found on the product. Also, please fill out and mail your warranty registration card promptly. It will be easier for us to notify you if necessary.

MODEL # _____

SERIAL # _____

This warranty gives you specific legal rights. You may have other rights which vary from state to state.

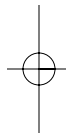
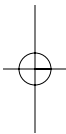

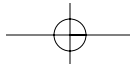

Index 49

-
- ac power cord.....25
 - accessories52
 - ant(enna) in jack.....6-10, 25
 - audio in/out jacks 10, 24, 25, 38, 46
 - automatic
 - playback43
 - rewind, eject, off.....43
 - batteries5
 - cbl/dbc button.....5, 19, 21
 - cassette compartment.....23
 - cassette-inside light23
 - ch3/ch4 switch6-9, 25
 - channel
 - above 100.....20
 - adding13
 - deleting13
 - reviewing14
 - setup11 - 14
 - ▲/▼ buttons21, 24, 43
 - clear button.....21, 41
 - clock display.....23
 - clock setting.....15
 - connections6-10
 - contents, table of4
 - controls
 - remote20-21
 - vcr23-25
 - counter only mode.....22
 - daylight-saving time16
 - display panel.....23
 - duplication38
 - eject button.....21
 - erasure prevention5
 - f.fwd/▶ button21, 24, 42
 - front panel.....24
 - glossary.....46
 - helpful hints.....44-45
 - hookups
 - with cable box/dbc8-9
 - with stereo tv.....10
 - without cable box/dbc6-7
 - language selection.....11, 17
 - line input mode12, 38, 46
 - long play32, 46
 - lp32, 46
 - memory button.....20, 41
 - menu button20
 - mute button.....21
 - number buttons20
 - on-screen status displays22
 - one-touch recording.....29
 - out jack6-9, 25
 - pause button.....24
 - pause/still button.....21, 27, 42
 - play/▲ button.....20, 24, 26, 42
 - playing.....26
 - power
 - button.....20, 24
 - cord25
 - pwr.(power) light.....23
 - real-time counter.....41
 - rear panel25
 - rec/otr button.....20, 24, 27, 29
 - rec(ord) light.....23
 - recording
 - basic.....27
 - one channel/
watching another28
 - timer30-33
 - with the vcr plus+
programming system34-37
 - remote control
 - buttons.....20-21
 - sensor.....24
 - using.....5
 - repeat play.....39
 - rerecording38
 - rew(ind)/◀ button20, 24
 - rf coaxial cable6-9, 38, 46
 - safety precautions3
 - searching42
 - sensor (remote).....24
 - slow
 - button21
 - motion.....42
 - slp32, 46
 - sp32, 46
 - speed button.....20
 - standard play.....32, 46
 - status display.....22
 - status/exit button.....20, 22
 - stereo TV hookups10
 - still picture.....42
 - stop/▼ button.....21
 - stop/eject button24
 - super high speed searching42
 - super long play32, 46
 - table of contents4
 - tape
 - duplication.....38
 - eject21, 24, 43
 - speed32, 46
 - time
 - search button20
 - (setting).....15
 - timer
 - light23
 - recording
 - cancelling.....33
 - checking.....33
 - setting30-32
 - with vcr plus+ programming
system.....34-37
 - tracking.....43
 - tv
 - button.....5, 18, 21
 - controls.....5, 18, 20-21
 - hookups6-10
 - position21, 24
 - vcr
 - button.....5, 21
 - light23
 - plus+
 - programming system34-37
 - plus+/enter button.....18-20, 36
 - position21, 24
 - vcr/tv button21, 24
 - video
 - in/out jacks.....10, 24, 25, 38, 46
 - volume ▲/▼ buttons.....21
 - warranty.....48

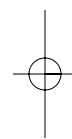
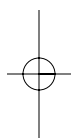

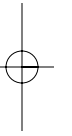
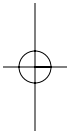
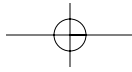

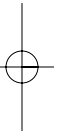
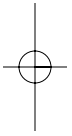
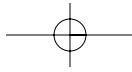

SUPPLIED ACCESSORIES

Check to be sure the items on this page are packed with your VCR. These accessories are provided to help you use or set up your VCR.

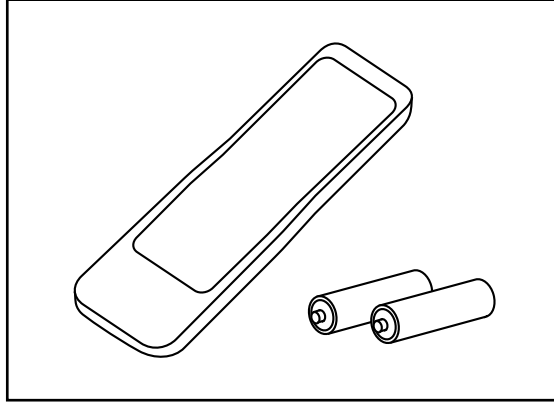

**Remote Control 4835 218 37213
Two AA Batteries 4835 138 17012**

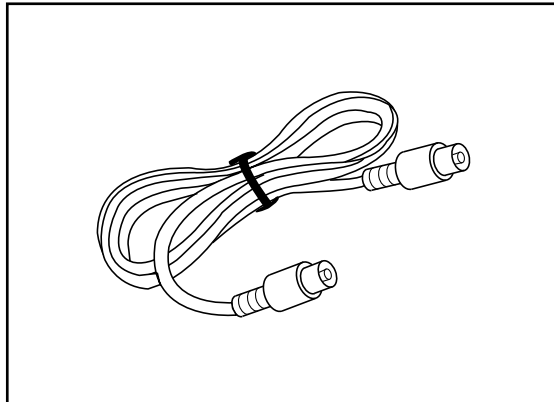

RF Coaxial Cable, 75 ohm 4835 323 27011

If any of these items are not included, or if you need to replace an item, contact Philips Service Solutions Group at the address below.

***Philips Service Solutions Group
P.O. Box 967
Greeneville, TN 37744-0967***

Or, call 1-800-851-8885.