



RS-1000 OLED

PROFESSIONAL **OLED 2-WAY 900 MHz. REMOTE CAR STARTER
& 6 CHANNEL ALARM SYSTEM
With
Built-in Temperature Sensor
And Serial Port Data Link**

OPERATION MANUAL

Please register your product at:
www.autopageusa.com

THIS PRODUCT IS DESIGNED FOR PROFESSIONAL INSTALLATION ONLY

OLED REMOTE TRANSCEIVER:

A. OLED REMOTE DISPLAY	4
The Remote Transceiver, XT-100 OLED	
B. CHARGING THE BATTERY	4
C. MAIN PAGE	5
D. SELECT THE TRANSCEIVER'S BUTTON CONFIGURATION	6
E. SELECT THE TRANSCEIVER FEATURES	6
P1-1: Enable / Disable Bi Sound While Pressing Button (7)	
P1-2: Button Lock Setting (7)	
P1-3: Melody / Vibration Mode (7)	
P1-4: Demo Mode (8)	
P2-1: Power Save Mode (8)	
P2-2: Parking Meter Setting (8)	
P2-3: "Light For OLED" Timer Setting (9)	
P3-1: Timer Setting (9)	
P3-2: Alert Alarm Timer Setting (9)	
P3-3: Count Down Timer Setting (10)	
P3-4: Daily Start Timer Setting (10)	
P4-1: Name of Transceiver Setting (11)	
P5-1: Name of Channel Setting (11)	
P6-1: Language Setting (11)	
P6-4: Set To Defaults (12)	

TABLE OF CONTENTS:

A. REMOTE TRANSMITTER OPERATION	12
B. LED DISPLAY	12
C. CHIRP INDICATOR	12
D. PARKING LIGHT	12
E. ACTIVE ARMING – ARM & LOCK	13
Ajar Warning	
Silent Arming	
Sensor By-Pass	
Hidden Alarm Mode	
F. PASSIVE ARMING	13
Passive Arming with Passive Door Locking	
Passive Arming By-Pass	
G. ACTIVE DISARMING – UNLOCK & DISARM	13
Silent Disarming	
Tamper Disarming	
Pathway Illumination	
Two Steps Door Unlock	
Automatic Re-Arm	
H. DISARMING WITHOUT A TRANSMITTER	14
Overrides the Alarm without Password Pin Code	
Overrides the Alarm with Password Pin Code	
I. VALET MODE	14
J. CAR LOCATOR	15
K. PANIC FUNCTION	15
L. TRIGGER THE SYSTEM	15
Stop The Melody Sound	
Noise Abatement Circuit	
M. ANTI CAR- JACKING	16
N. SYSTEM'S TRIGGER CHECK	16
O. SYSTEM'S STATUS CHECK	16
P. DRIVER PAGING / LOSE AND FOUND	17
Q. DOME LIGHT CONVENIENCE DELAY & SUPERVISION	17
R. IGNITION CONTROL THE DOOR LOCK/UNLOCK.	17
S. TRUNK RELEASE (CHANNEL 3) OUTPUT	17
T. CHANNEL 4 / 5 / 6 TIMER CONTROL OUTPUT	17
U. MULTI-VEHICLE SECURITY OPERATION:	17
V. OUT OF RANGE INDICATION:	18
W. POWER ON MEMORY.	18

REMOTE START OPERATION:

A. TO REMOTE START THE VEHICLE	18
B. TO OPERATE THE VEHICLE WHILE RUNNING ON THE REMOTE START	18
C. TEMPORARY STOP FEATURE	19
D. TURBO TIMER MODE	19

E. TIMER START	19
3 (2 or 1) Hours Timer Start	
Daily Timer Start	
Cancel the Timer Start	
F. TEMPERATURE CHECK	20
G. TO TURN OFF THE REMOTE START	20
H. SHUT-DOWN INPUT FOR REMOTE STARTER	20
I. DISABLING THE REMOTE START SYSTEM	20
TEST MODE	20
Warranty Information.....	21

Congratulations on your purchase of the RS1000 OLED remote start vehicle security system. We sincerely hope the purchase of the RS1000 remote start security system gives you peace of mind.

The RS1000 LCD is a state-of-the-art two-way communication system. Please take the time to read over this manual to thoroughly familiarize yourself with the many features and options of the RS1000.

Auto Page, Inc. has over 25 years of experience in the vehicle security industry in the United States and is a wholly owned subsidiary of Iwata Electric Co., of Tokyo, Japan. Iwata has been an industry leader for over 50 years, establishing a reputation for ingenuity in its engineering capability and innovative communication products. Auto Page and Iwata maintain a long tradition of providing the best value to their customers.

WARNINGS:

As with any product that performs automatic functions, there are certain safety precautions that you must practice and be aware of.

1. Keep the transmitter out of children's reach.
2. Do not leave anyone in the vehicle while running on remote control.
3. Alert servicing personnel that the vehicle can be started automatically.
4. Do not start the vehicle by remote while it's in an enclosed area or garage.
5. Always apply the parking brake and lock the vehicle as you exit the vehicle.
6. The vehicle windows must be rolled up.
7. Should the unit malfunction, disconnect the fuse until the problem is corrected.
8. The use and operations of this system is the sole responsibility of the operator.
9. Some areas may have local ordinances that prohibit leaving a vehicle running on public streets.
10. It is not safe to remote start the vehicle if the vehicle is parked on a steep incline.

REMOTE TRANSCIEVER (TX)

A. OLED DISPLAY

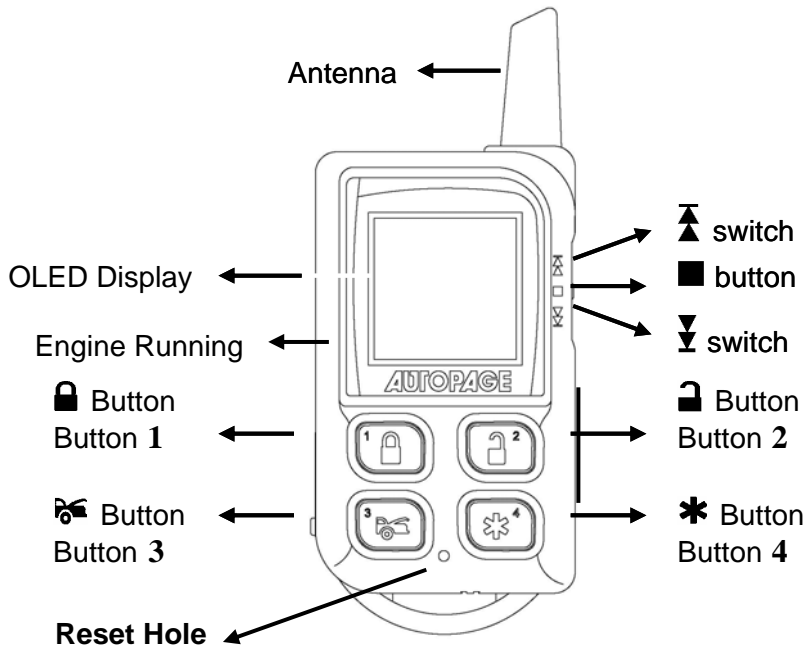
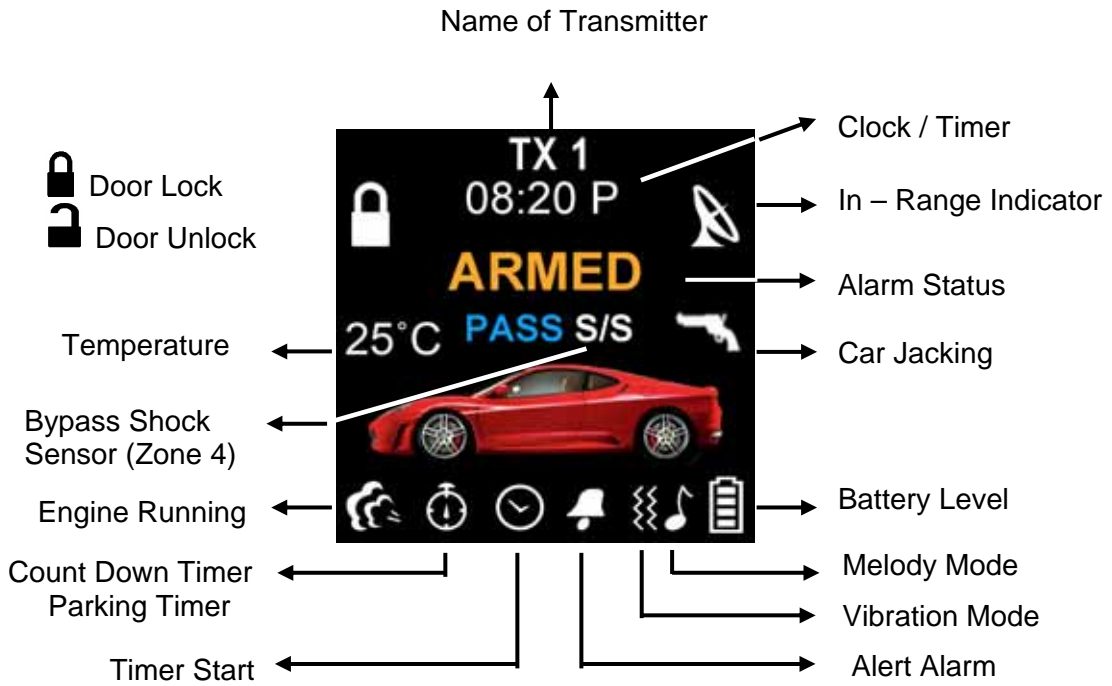

B. CHARGE THE BATTERY

The unit has a built-in 3.7V lithium polymer battery. If the OLED screen display low battery or the  icon is flashing, your remote transceiver needs charging. Please use the included AC / USB charger to charge the battery. While the battery is charging, you can push the "■" button to check charging condition. The battery should be charged at least once a month under normal operation.

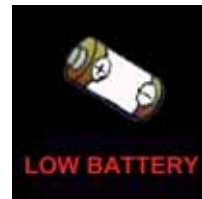

AC Power Supply:

The remote transceiver equipped AC POWER SUPPLY / AC ADAPTOR (Output Voltage: 4.2VDC – 5.5VDC and with same USB plug), then you can charge the battery indoors.

This screen will be displayed while the battery of the Remote Transceiver is charging.



C. MAIN PAGE:

1. Press the button, the screen will display the main page.

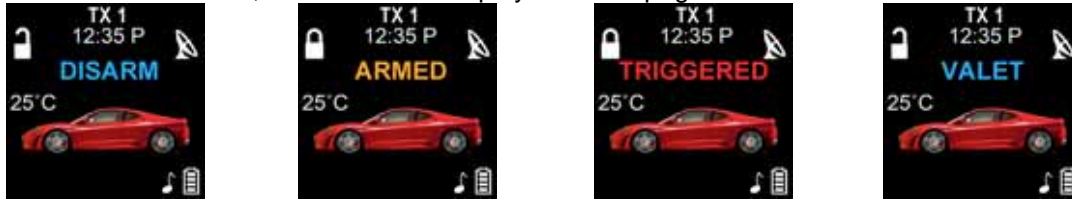

2. When an icon is flashing on the OLED screen, press the button. The OLED screen will display the details of the flashing icon. The sequence of flashing icons is as follows: TRIGGERED / ENGINE RUNNING / COUNT DOWN TIMER / TIMER START / ALART TIMER conditions.



While the **TRIGGERED** icon is flashing.

Push the button to display the triggered area.

or

or

or



While the icon flashes

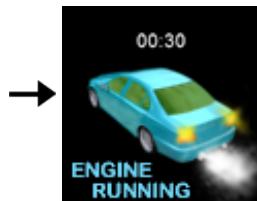

Push the button



While the icon flashes.



Push the button and the count down timer will be displayed.



Press button 2 to stop the count down time.

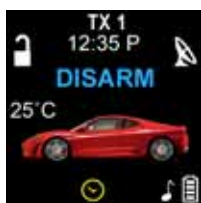

While the icon flashes. Push the button, the OLED screen will display individually i.e. daily start timer, timer start or temperature start, depending on which you have selected.



or



or

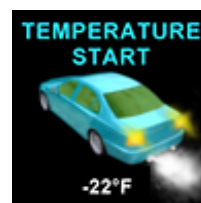



While the icon is flashing.



Push the button, the alert alarm time will be displayed.



Press button 2 to turn OFF the alert alarm timer.

D. SELECT THE TRANSCIEVER'S BUTTON CONFIGURATION:

- Spin the jog shuttle up Switch to select the transceiver button configuration. The OLED screen will display the transceivers button configuration you would like to select.
 - Within 5 seconds, press buttons 1, 2, 3 or 4 to select the remote controls "button configuration".
- Note: If 5 seconds of inactivity expired, or the button is pressed, the transceiver button configuration mode will exit.



Spin up the switch to page 1.



Spin up the switch to page 2.



Spin up the switch to page 3.



Spin up the switch to page 4.



Spin up the switch to page 5.



Spin up the switch to page 6.



Spin up the switch to return to the main page.

E. SELECT THE TRANSCIEVER FEATURES:

- Spin the jog shuttle down Switch to select the transceiver feature you need and the OLED screen will display the features you have selected.
 - Press buttons 1, 2, 3 or 4 once within 3 seconds after making a selection and the OLED screen will change to the alternative display.
- Note: If 5 seconds of inactivity expires or if the button is pressed, the transceiver features program mode will exit.



Spin down the switch to page 1.



Spin down the switch to page 2.



Spin down the switch to page 3.



Spin down the switch to page 4.

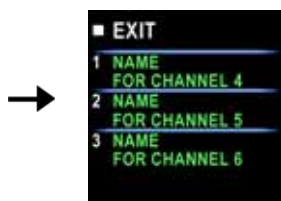

Spin down the switch to page 5.

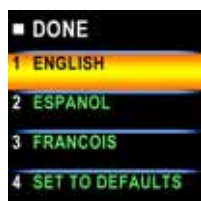

Spin down the switch to page 6.

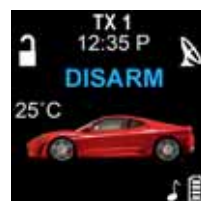

Spin down the switch to return to the main page.

E- P1- 1. “BUTTON BI” SETTING: Example: Set the “Button Bi Disable”.

The unit has a short “bi” sound while pressing the buttons of the remote transceiver



Spin down the  switch to page 1.

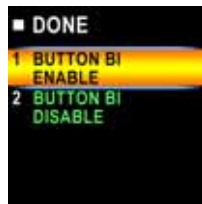

Press button 1 and it will display the previous setting.

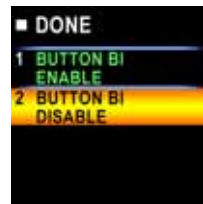

Press button 2 to change the setting.

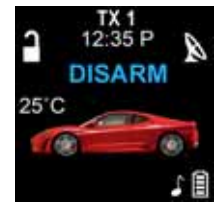

Press the  button and the setting is complete.

E- P1- 2. “BUTTON LOCK” SETTING: Example: Set the “Button Lock Enable”.



Spin down the  switch to page 1.

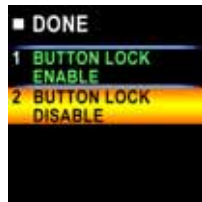

Press button 2 and it will display the previous setting.

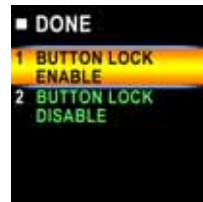

Press button 1 to change the setting.



Press the  button and the setting is complete.

D- P1- 3. “MELODY / VIBRATION MODE” SETTING: Example: set the Vibration mode.



Spin down the  switch to page 1.



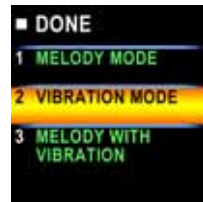

Press button 3 and it will display the previous setting.

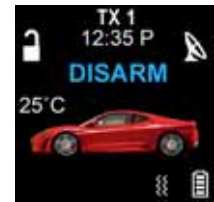

Press button 2 to change the setting.



Press the  button and the setting is complete and the  icon will display on the OLED screen.

E- P1- 4. “DEMO MODE”: To display the units demo mode

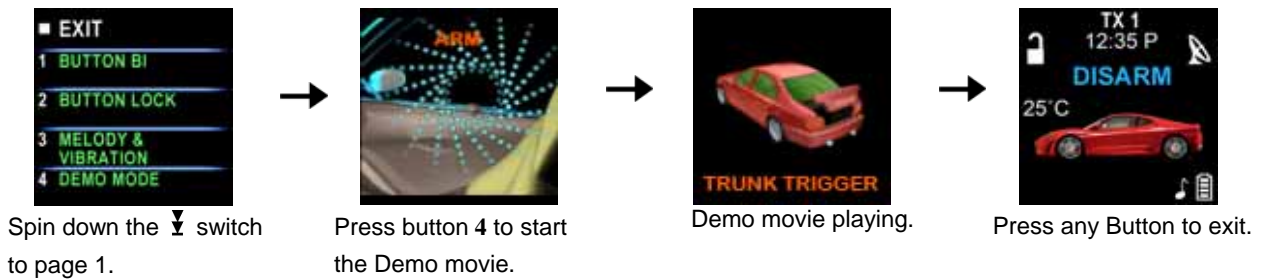

E- P2- 1. “POWER SAVE” SETTING: Example set the “Power Save Enable”.

While in the power save mode, the LCD remote transceiver uses “0” current to save the battery power.

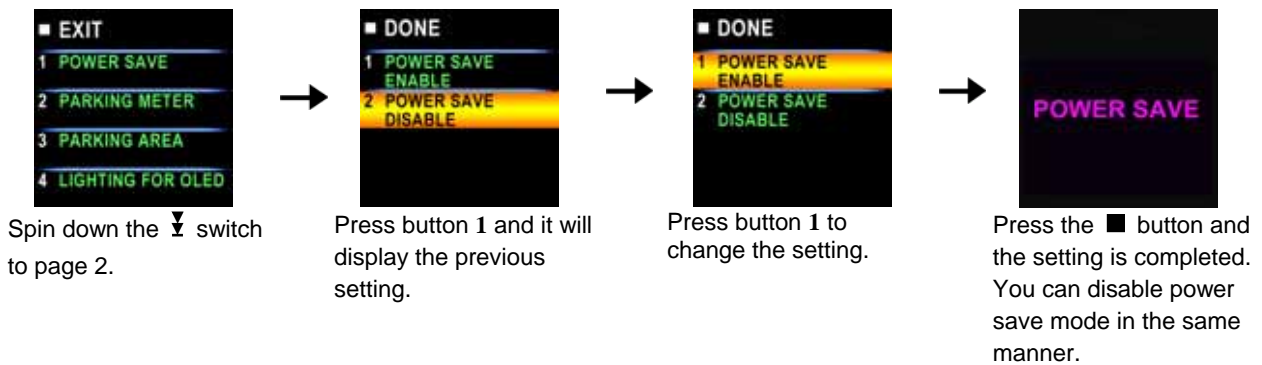

E- P2- 2. “PARKING METER” SETTING: Parking timer: Example set the “Parking Meter 30 min..

Note: When the “parking meter” expires, press any button to stop the beeper.

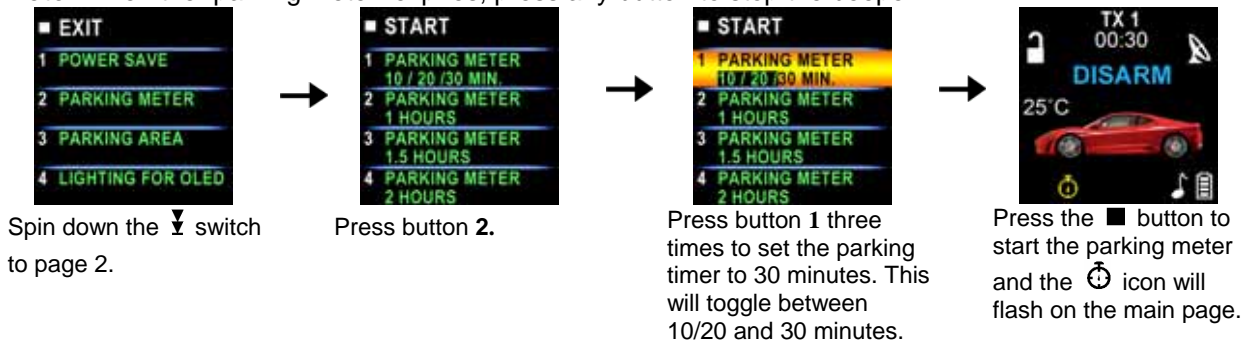

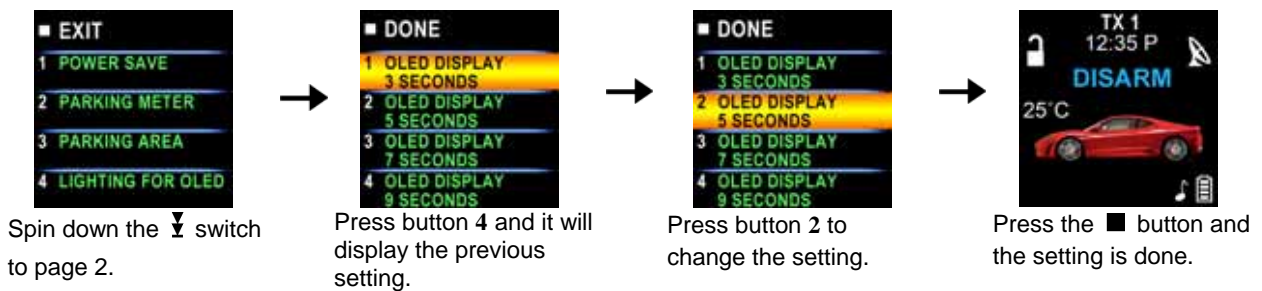

D- P2- 3. “LIGHTING FOR OLED” SETTINGS: Example: Set the ON time for the OLED display from 2 seconds to 3 seconds.



D- P3- 1. "TIMER / CLOCK" SETTINGS: Example: set the clock to **08:20PM**



Spin down the  switch to page 3.



Press button 1 and the "hours" digit flashes for adjusting.



Press button 2 to set the "hours" digit to "08". This can also be done with the jog shuttle.



Press button 1 and the "minutes" digit flashes for adjusting.



Press button 2 to set the "minutes" digit to "20". This can also be done with the jog shuttle.



Press button 1 and the "A" digit flashes for adjusting. AM or PM.



Press button 2 to set the "P".





Press button 3 and the setting is completed.

D- P3- 2. "ALERT ALARM TIMER" SETTING: Example set alert alarm timer to 06:30A

Note: When alert alarm timer trigger press any button to stop the beeper.



Spin down the  switch to page 3



Press button 2 and the "hours" digit flashes for adjusting.



Press button 2 to set the "hour" digit to "06". This can also be done with the jog shuttle.





Press the button 1 and the "minutes" digit flashes for adjusting.





Press button 2 to set the "minute" digit to "30". This can also be done with the jog shuttle.



Press button 3 to set the alert alarm timer and the  icon will flash on the main page.



Push the  button While the  icon is flashing or when alert alarm timer trigger, the screen will display the alert alarm timer.



Press button 2 to turn OFF the alert alarm timer or press any button to stop the alarm while alert alarm timer is triggered.

C- P3- 3. “COUNT DOWN TIMER” SETTING: Example: set the count down timer to **2:30**

Note: When count down timer is triggered, press any button to stop the beeper.

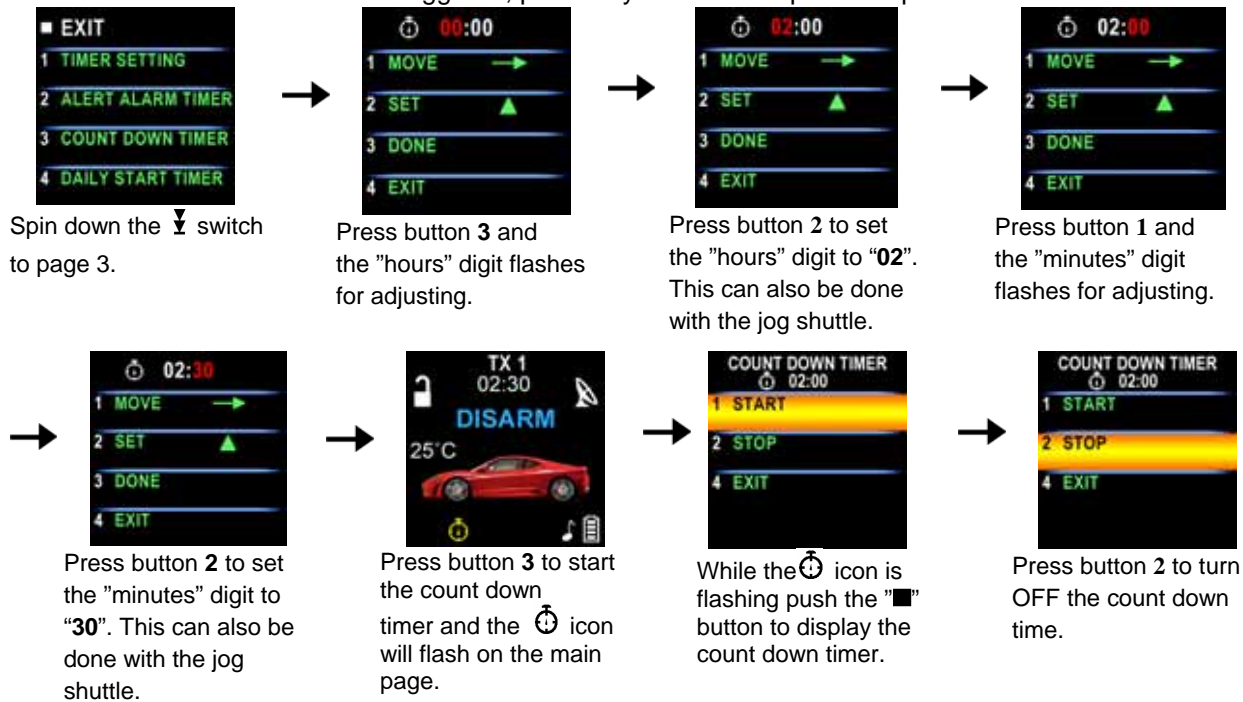

C- P3- 4. “DAILY START TIMER” SETTING: Example set the Daily Start Timer to **05:00A**. This is to set the start time. Please refer to daily start timer operations to use the daily timer start. (Page # 19)

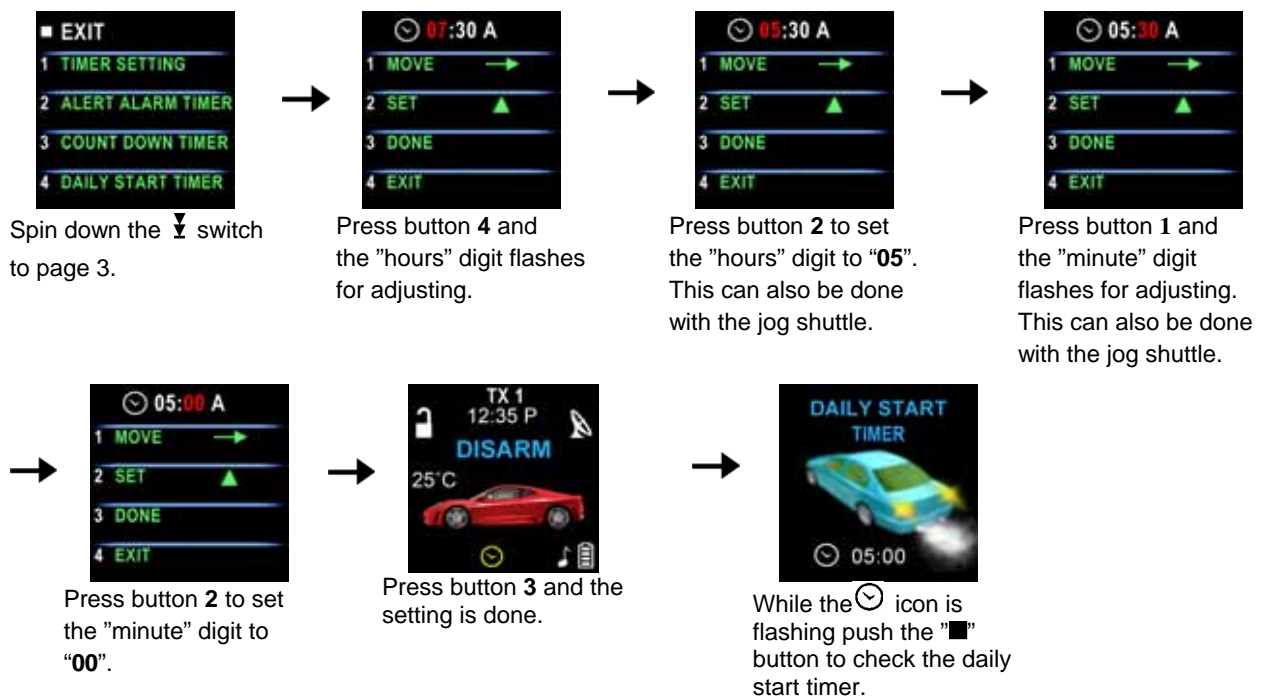

D- P4- 1. "NAME OF TX " SETTING: Example Set Name of Transceiver 1 to **MIKE**



Spin down the ∇ switch to page 4.



Press button 1 and the "-" flashes for setting.



Spin down the ∇ switch to set the "M".



Press button 1 and the "-" flashes for setting.



Spin up the \blacktriangle switch to set the "I".



Press button 1 and the "-" flashes for setting.



Spin down the ∇ switch to set the "K".



Press button 1 and the "-" flashes for setting.



Spin up the \blacktriangle switch to set the "E".



Press button 3 and the setting is done.

D- P5- 1. "NAME OF CHANNEL " SETTING: Example Set Name of channel 4 to **GARAGE DOOR**



Spin down the ∇ switch to page 5.



Press button 1 and the "-" flashes for setting.



Spin up the \blacktriangle switch to set the "G".



Press button 1 and the "-" flashes for setting.



Spin down the ∇ switch to setting the "A".

Following the above step to setting Alphabetical to **GARAGE DOOR**



Press button 1 and the "-" flashes for setting.



Spin down the ∇ switch to set the "R".



Press button 3 and the setting is done.

D- P6- 1. LANGUAGE SETTING: Example set the Language to **English**



Spin down the ∇ switch to page 6.



Press button 1 to set the Language to "ENGLISH".

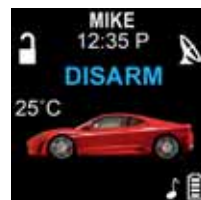

Press the \blacksquare button and the setting is done.

D- P6- 2. SET TO DEFAULTS:



Spin down the switch to page 6.



Press button 4.

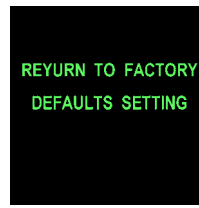

Press buttons 1 & 2 at same time to set the defaults.

OPERATION:

A. REMOTE TRANSMITTER OPERATION:

Transmitter Button	System Function	Remark
1	Lock Doors & Arm System / Button 1	
-	Arm and Bypass Zone 4. Shock Sensor	Press twice within 3 seconds
then	Arm System and Hidden, (Silent) Alarm Function	Press within 3 seconds
	Car Locator	Upon armed
(3-second)	Panic function	Press and Hold for 3 seconds. To cancel.
+	Silent Arming / Disarming	Ignition in "off" position.
+ (2-second)	Active Anti Car-Jacking Mode. Programming required	Ignition in "on" position press and hold for 2 seconds
2	Unlock Doors & Disarm System / Button 2	
-	Two Steps Door Unlock & Disarm System	Press twice within 3 seconds.
3 (3-second)	Trunk Release (Channel 3)	Press and Hold for 3 seconds
-	Passive Arming By-pass	While the system Disarmed.
* 4	Turn ON & Off The Remote Start / Button 4	.
* - *	Safety Start. Programming required	Press twice within 3 seconds.
+	Channel # 4 Timer Output	Programming required
+	Channel # 5 Timer Output	Programming required
+ *	Channel # 6 Timer Output	Programming required
	Switching code For 2nd Car Operation.	For regular remote transmitter
	Button Function Selection	For Two way Remote transceiver
	Confirm Button / Back to Main Page	For Two way Remote transceiver
	Feature Selection	For Two way Remote transceiver

B. LED display:

LED	Function
Off	Disarmed
Slow Flash	Armed
Fast Flash	Passive Arming
On (Solid)	Valet Mode
Pause On	Password Lock-Out

LED	Function
1 flashes... pause	Zone 1 / Trigger on Hood
2 flashes... pause	Zone 2 / Trigger on Trunk
3 flashes... pause	Zone 3 / Trigger on Door Switch
4 flashes... pause	Zone 4 / Trigger on Shock Sensor
5 flashes... pause	Zone 5 / Trigger on Ignition Switch

C. CHIRP INDICATORS:

Chirp	Function
1 chirp	Arm
2 chirps	Disarm
3 chirps	Ajar Warning
4 chirps	Disarm / Triggered
6 chirps	Car Locator

D. PARKING LIGHT:



Parking light	Function
1 flash	Arm
2 flashes	Disarm
3 flashes	Disarm / Triggered
12 flashes	Car Locator
Constant On	Under Remote Start

E. ACTIVE ARMING – LOCK & ARM:

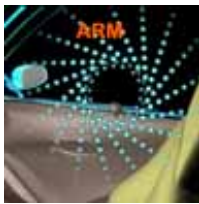

1. Press the  button on the transmitter.
2. The siren will chirp once and parking light will flash once indicating that the system is now armed. The vehicle door will lock upon arming when interfaced with the security system.



AJAR WARNING: If the siren sounds 3 chirps, then you have left a door, trunk, or hood lid ajar.



SILENT ARMING: Spin up the  switch to the page 1 and then press the “Silent Arm” button or press the transmitter  and  buttons at the same time to arm your security system, No chirp sound will be heard, arm confirmation will be through the vehicles parking lights only.

SENSOR BY-PASS:

Bypass The Zone 4: Spin up the  switch to the page 2 and then press the button 1 or press the  button on the transmitter two times within 3 seconds. This will arm the security system and by-pass the zone 4-shock sensor.



The system will chirp one additional time to confirm the sensor bypass mode was activated. The sensor bypass feature is programmed to activate for one arming cycle only. The security system will return to normal operation during the next arming cycle.

HIDDEN ALARM FUNCTION (Silent Alarm): Spin up the  switch to the page 1 and then press the “Hidden Alarm” button or press the  button first; within 3 seconds press the  button to activate the hidden alarm function. The security system will arm and with “Hidden Alarm Function” The siren / horn will be silenced even if the unit is triggered in the armed status. Notification will only be through the hand held two-way remote.





F. PASSIVE ARMING (Programming Required)

Active arming / disarming is controlling your security system via the remote transmitter. This security system is equipped with an optional Passive Arming feature which allows the security system to arm 30 seconds after the last door is closed. Operation is as follows.

1. Turn the ignition to the “OFF” position and exit the vehicle.
2. After all entrances are closed, the security system LED will flash fast for 30 seconds. If you reopen any door / hood / trunk, the security system LED will stop flashing. It will begin flashing again once the vehicle all entrances are closed.
3. After 30-second timer has elapsed, the security system will automatically “ARM”. The siren will chirp [1] time and the parking lights will flash [1] time.

PASSIVE ARMING WITH PASSIVE DOOR LOCKING:



The vehicle doors will automatically lock after passive arming cycle has been completed.

PASSIVE ARMING BY-PASS: While the system disarmed, Press the  button twice, the security will respond with [1] chirp and LED will turn “ON”. The security system will remain in this temporary state for as long as you wish. To exit passive by-pass, press the transmitter  or  button and the system will return to normal status.

G. ACTIVE DISARMING – UNLOCK & DISARM:

1. Press  button on the transmitter.
2. The siren will chirp twice and parking light flash twice to indicating that the security system is now disarmed. The vehicle’s door will unlock and dome light turns on for 30 seconds upon disarming when interfaced with the security system.



SILENT DISARMING: Spin up the  switch to the page 1 and then press the “Silent Disarm” button or press the transmitter  and  buttons at the same time to disarm your security system, No chirp sound will be heard, arm and disarm confirmation will be through the vehicles parking lights only.

TAMPER DISARMING: If alarm triggered, upon disarming the system, the siren will chirp 4 times and the parking light will flash 3 times.

PATHWAY ILLUMINATION: This feature turns the parking lights “ON” for 30 seconds upon an unlock signal and for 10 seconds upon the lock signal. (Programming required)

TWO STEPS DOOR UNLOCK: This feature will independently unlock the driver’s door only when disarming the security system. Pushing the  button a second time within 3 seconds will unlock the other doors. (Additional installation is required)

AUTOMATIC RE-ARM: If this feature is selected, the security system will automatically re-arm itself in 60 seconds after disarming with remote transmitter. Automatic rearm will cancel if the ignition is turned ON and will pause if any door is opened before the 60 seconds timer has elapsed.

H. DISARMING WITHOUT A TRANSMITTER

OVERRIDES THE ALARM WITHOUT PASSWORD PIN CODE: (Factory Default Setting)

The Override function may be used if the remote transmitter is lost or inoperative.

1. Enter the vehicle and turn the ignition switch to 'ON' position. (Alarm will sound.)
2. Within 10 seconds push and release the valet switch

The alarm will stop sounding and enter the disarmed mode. You can now start and operate the vehicle normally.

OVERRIDE THE ALARM WITH PASSWORD PIN CODE:

If the valet switch is located in a place that can be easily found, this security system allows the consumer to program a password pin code offering a higher level of security.

1. Enter the vehicle and turn the ignition switch to the 'ON' position. (Alarm will sound.)
2. Within 5 seconds, enter your chosen the first digit code by pressing and releasing the Valet Switch. (When you are finished with the above procedures, the system's siren stops alarming and the parking lights stop flashing, but the vehicle cannot be started and driven away.)
3. If you use one digit to be a password pin code, skip to Step 6. If you use two digits to be a password pin code, advance to Step 4.
4. Within 15 seconds of the last digit code enter (the 1st code), turn the Ignition Switch “Off” and then “On”.
5. Within 15 seconds, enter your chosen of the second digit code by press and release the Valet Switch.
6. Turn the ignition switch to the “OFF” position. [4] Chirps form siren/horn, [3] flash from parking light to indicate the system was disarmed.

Note: If someone keys-in the wrong password pin code, the system allows him to make 2 mistakes. If the third code is still wrong, it will automatically shut down for 5 minutes. During this period the system will not accept any code and the LED will “pause on” (the LED will turn on 1 second and turn off 0.1 second).

EXAMPLE: To Override The System With The Password Code 83, you would;

1. Enter the vehicle and turn the ignition switch to 'ON' position. (Alarm will sound.)
2. Within 5 seconds, Press and Release the Valet Switch 8 times (When finish the above procedure, the system's siren will stop alarming and the parking lights will stop flashing, but the vehicle cannot be started and driven away.)
3. Within 15 seconds of the last digit code enter (the 1st code), turn the Ignition Switch “Off” and then “ON”.
4. Within 15 seconds, Press and Release the Valet Switch 3 times
5. Turn the Ignition Switch to “Off” position. [4] Chirps form siren/horn and [3] flashes from the parking light will indicate the system has been disarmed.

I. VALET MODE: (System in Disarm or Valet mode)

The valet switch allows you to temporarily bypass all alarm function, eliminating the need to hand your

transmitter to a parking attendants or a garage mechanic. When the system is in valet mode, all alarm function and remote start functions are bypassed, however the remote panic feature and remote door locks will remain operational. To use the valet mode, the system must first be disarmed.



Enter Valet Mode:

1. From the disarmed condition, turn the ignition to the “ON” position.
2. Push and hold valet switch for 2 seconds until the LED turns on solid. The LED will remain on as long as the system is in 'valet mode'.



Exit Valet Mode:

1. To return to normal operation, turn the ignition 'ON'.
2. Push and hold valet switch for 2 seconds. The LED will turn off to indicate the system has exiting the valet mode.

J. CAR LOCATOR

While the system is armed, press the button to activate car locator function. The siren will chirp 6 times. The parking lights will flash 12 times, for you to easily locate your vehicle.



K. PANIC FUNCTION:

The transmitter can be used as a remote panic switch to manually trigger the alarm in case of an emergency.

1. Press and hold the button for 3 second. The alarm will immediately sound and the “Panic” icon will display on the OLED screen.
2. During panic mode, the normal function of this transmitter button will be suspended. The transmitter and buttons can be used to lock and unlock the door (if the option is installed), however once the button is pressed, the vehicle’s starter disable device, (where installed) will be enable allowing the vehicle to start.
3. To stop the alarm press the transmitters . The panic mode will be turned off immediately.
4. If the button is not pressed, the alarm will automatically stop after 30 seconds.



L. TRIGGERING THE SYSTEM

When armed, your vehicle is protected as follows:

1. Light impact will trigger the warn-away signal.
2. Heavy impacts / Doors open / Hood open / Trunk open / Turning on the ignition key will trigger the programmed sequence.

The starter disable relay (if installed) prevents the vehicle’s starter from cranking. The siren, horn, parking lights, and dome light will turn on to alert of an intrusion for 30 seconds. Then it will stop and automatically reset and re-arm. If the sensors or detectors are still active, the alarm system will sound a maximum of 6 times of 30 seconds cycles.



Stop The Melody Sound: While triggering the alarm the OLED screen will alert user through melody sound and flashing trigger icon, press any button on the OLED remote transceiver to stop melody sound.

NOISE ABATEMENT CIRCUIT: Your system has “Noise Abatement Circuit”. It can prevent annoying repetitive trigger sequences due to faulty door pin switches or environmental condition such as thunder, jackhammers, airport noise, etc.



Here's how the "Noise Abatement Circuit" works: If the alarm triggers five times, each time the same sensor (zone 4) is triggered the "Noise Abatement Circuit" will interpret this pattern of triggers as false alarms. After the fifth trigger, the "Noise Abatement Circuit" ignores, or bypasses that sensor until any other sensor or switch is triggered.

"Noise Abatement Circuit" covers doors (Hood/Trunk) differently: If the alarm is triggered by an open door for six full cycles, the doors will be bypassed until the trigger ceases.

M. ANTI CAR- JACKING (Programmable)

Warning: If you do not need the car jacking function in this alarm system, be sure to set the car jacking feature "OFF". This systems default setting is car-jacking feature "OFF".

ACTIVE ANTI CAR JACKING:

1. Spin up the  switch to the page 1 and then press and hold the "Car Jacking" button for 2 seconds or press and hold the transmitter  and  buttons at the same time for 2 seconds while the vehicle's ignition is ON. The parking lights will turn on for 1.5 seconds to indicate the system has entered the car-jacking mode.
2. Once the system is in car-jacking mode and you are forced from the vehicle, the system will be triggered when the door is opened and closed while the ignition is in the "ON" position.

PASSIVE ANTI CAR- JACKING: (Programmable)

1. Turn the ignition switch to the "ON" position. The system enters the car-jacking mode.
2. Once the system is in car-jacking mode and you are forced from the vehicle, the system will trigger when the door is opened and closed while the ignition is in the "ON" position.



TRIGGER SEQUENCE OF THE ANTI CAR - JACKING MODE:

- a). 50 seconds after the system has beer triggered. The siren will start chirping for 15 seconds.
- b). During this 15 second period of chirping, you will be alerted to push the valet switch once to turn off the car-jacking feature. If not, it will enter the second timer of the car jacking sequence.
- c). 65 seconds after the system has beer triggered the siren starts alarming and the parking lights will start flashing.
- d). 90 seconds after the system has beer triggered
 1. The siren will still be alarming and the parking lights will continue flashing.
 2. The starter disable will activate to prevent the vehicle from starting if stopped.
 3. It will remain active until the vehicle's battery power is exhausted.

OVERRIDE THE SYSTEM TO TURN OFF ANTI CAR- JACKING:

Turn the ignition switch from OFF to ON and within 10 seconds push valet switch, the siren will stop and the system will be disarmed

***Note:** If you use password pin code to double protect the vehicle security, you will need to use it to completely disarm the system.

N. SYSTEM'S TRIGGER CHECK

Spin up the  switch to the page 4 and then press the "Trigger Check" button. The remote will respond with one melody sound and all trigger records will immediately be displayed on the OLED screen.

Note: It will display the homepage if there were no system's triggered.

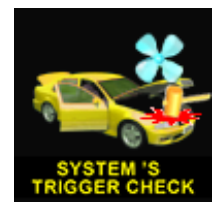

O. SYSTEM'S STATUS CHECK

Spin up the  switch to the page 4 and then press the "Status Check" button. The remote will respond with one melody sound and the vehicles status will immediately be displayed on the OLED screen.

Note: It will display the home page if the car's status is normal.

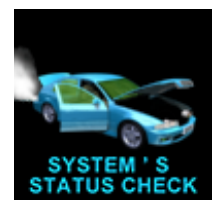

P. DRIVER PAGING / LOST & FOUND

This feature is useful in the event that someone wants to page the driver of the parked vehicle or you cannot find his OLED remote transceiver.



Indoor Driving Paging

If the ignition switch is in the "off" position, press and hold the valet switch for 2 seconds to page the driver. One chirp sound shall be emitted from the vehicle and the paging melody will sound from your Remote OLED transceiver. "DRIVER PAGING" indication will flash on the OLED screen.



Outdoor Driving Paging (optional)

If someone tries to page you by tapping the paging (knock) sensor, the paging melody will sound on your Remote OLED transceiver and "DRIVER PAGING" indication will flash on the OLED screen. The knock sensor is usually located on the driver's side of the front windshield.

1. Spin up the  switch to the page 4 and then press the "Driver Pager" button. It will respond with chirps from the vehicle. A melody sound and "DRIVER PAGING" indication flashes on the OLED screen to confirm the function has been turned ON.
2. When tapping the paging (knock) sensor on the vehicle, one chirp sound will be emitted and the paging melody will sound from you Remote OLED transceiver. The "DRIVER PAGING" indication will flash on the OLED screen.
3. Turning ON the ignition switch or pressing the  button or  button will exit the driver paging mode.

Q. DOME LIGHT CONVENIENCE DELAY & SUPERVISION

The alarm has a unique feature, which will turn on your vehicle's dome light as follows:

1. Upon disarming, the interior light will remain on for 30 seconds.
2. If the vehicle is intruded, the interior light will flash for the same duration as the siren.

Note: Turning ON the ignition switch or arming the alarm will turn off the dome light.

R. IGNITION CONTROL DOOR LOCK/UNLOCK.



If the vehicles power door locks have been interfaced to the security system, the system will automatically lock the vehicle's doors in 3 seconds when the ignition is turned "ON" and /or unlock the vehicle's doors when the ignition is turned "OFF". (Programmable)



S. TRUNK RELEASE (CHANNEL 3) OUTPUT.



Press and hold  button on the transmitter for three seconds to remotely control the trunk release or other electric devices.



T. CHANNEL 4/5/6 TIMER CONTROL OUTPUT

Activate The Channel 4: Spin up the  switch to the page 3 and then press the "Channel 4" button or press the transmitter  and  buttons at the same time to active Channel 4 function.

Activate The Channel 5: Spin up the  switch to the page 3 and then press the "Channel 5" button or press the transmitter  and  buttons at the same time to active Channel 5 function.

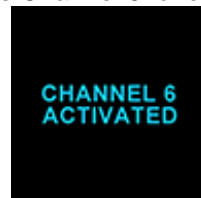
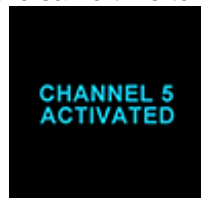
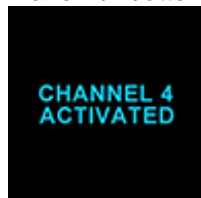

Activate The Channel 6: Spin up the  switch to the page 3 and then press the "Channel 6" button or press the transmitter  and  buttons at the same time to active Channel 6 function.



U. MULTI- VEHICLE SECURITY OPREATION:

Your remote transmitter can be utilized to control multi- vehicle security system, to program the remote control transmitter to a second vehicle, follow the instructions for Transmitter programming. All programming parameters will be the same except for the following:

For Regular Remote Control Transmitter:

1. Prior to pushing any button on the transmitter. Press the Select  button first on the transmitter.
2. Once  button is pressed the LED on the transmitter will illuminate for 3.5 seconds to indicate the second transmitter pin code is ON.
3. While the LED is illuminated, press any button on the remote control transmitter to control a second vehicle security system.

For 2-way OLED Remote Control Transceiver:

A maximum of four vehicle's security systems can be controlled by this transceiver.



TX1 Red Vehicle

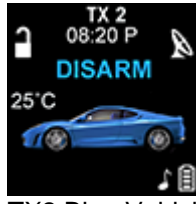

TX2 Blue Vehicle

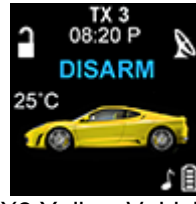

TX3 Yellow Vehicle



TX4 Green Vehicle



Spin up the switch
To page 6

→ The four transmitters will be display on the OLED screen, you can chose one of the four transmitters to control your vehicle security system.



→ Pressing button 3 will set the remote. . "TX 3" will be displayed on the OLED screen

→ Now you can press button to remote control The "TX 3" yellow vehicle's security system.

V. OUT OF RANGE AND TEMPERATURE INDICATION:

If this feature is selected, the system will automatically check the range and update the temperature every 33 minutes.

1. If the user is within the range, the icon will display on the OLED screen.
2. If the user is out of range, the remote will have five short "bi" sounds and the "Out Of Range" icon will appear on the OLED screen.

Note: Programming "Out Of Range and Temperature Indication" will decrease the life expectancy of battery.



W. POWER ON MEMONRY:

This security system is equipped with circuitry that will allow the unit to remember its alarm state if the power is lost and then reconnected.

REMOTE START OPERATION:

A. TO REMOTE START THE VEHICLE:

1. Press the * button on the transmitter. Twice if safety start has been programmed.
2. The parking light will activate to indicate the remote start received the signal. (A melody sound from your Remote OLED transceiver and "🌀" icon will flash on the OLED screen to confirm the remote start was activated.)
3. The engine will start in approximately 5 seconds.
4. Once the engine is running, after the parking lights will turn on again and your climate controls will activate and adjust the vehicles interior temperature to your Preset setting. (While the vehicle is running, the "Engine Running" icon and the "minutes" digit on the OLED screen will flash. It will indicate a count down timer based on the 5, 10, 20 or 30 minute run time set up by your installation center.)
5. The vehicle will run for a 5 to 30 minute cycle and automatically shut down. (When the unit shuts off the count down timer will turn off and the transmitter will play a melody.)



Note: The Remote Start Unit will not start the vehicle if any one of the following conditions exists:

1. The hood is opened.
2. The brake pedal is pressed.
3. Move the optional remote start enable toggle switch to OFF position. (If installed)
4. The gear selector is in any gear other then "PARK" or "NEUTRAL"

B. TO OPERATE THE VEHICLE WHILE RUNNING ON THE REMOTE START:

To operate the vehicle while engine running on the remote start.

1. Enter the vehicle and insert the ignition key. Turn it to "ON" not the start position.

2. Press the brake pedal.

Note: If the brake pedal is pressed before the key is in the ON position, the engine will shut down.

C. TEMPORARY STOP FEATURE:

This feature allows the vehicle to remain running after the key has been removed from the ignition. This feature is useful for occasions when you wish to exit and lock the vehicle for short periods of time, but would like to leave the motor running and the climate control on.

1. Before turning off the engine, press the * button on the transmitter. Twice if safety start has been programmed. The LED indicator will flash 3 times to confirm.
2. Turn the ignition key to OFF position. (The engine will stay running.)
3. The engine will run until the pre-programmed time elapsed or a shutdown input is received.

D. TURBO TIMER MODE:

Turbo timer mode keeps the engine running after arriving at your destination for a programmable period of 1, 3 or 5 minutes. This allows the system time to conveniently cool down the turbo after you have left the vehicle. To activate the turbo timer:

1. While engine is running, place the transmission gear in the park position and pull up the hand brake.
2. Before turning off the engine, Spin up the ▲ switch to the page 5 and then press the "Turbo Start" button or press and release 🗑 and * buttons at the same time.
-- The parking light will activate to indicate the remote start has entered turbo timer mode. --
3. Pull out the "Ignition Key" from the key cylinder.
-- The engine will continue to run. --
4. Exit and secure the vehicle.
-- Engine continues running until the pre-programmed time has elapsed. --

If you do not want the vehicle to continue running, simply step on the vehicle's brake, or activate the * button in succession. Any of these will cause the engine to turn off.



E. TIMER START:

Your system has the ability to automatically start the vehicle every 1, 2 or 3 hours and run for the pre-programmed time (5, 10, 20 or 30 minutes), and then shut off. This will continue for 6 cycles. This feature is especially useful in cold climates where the only means to keep the engine and engine fluids warm is to periodically start the engine.

If the system is set up to start in temperature mode, the system can be programmed to automatically start the vehicle's engine whenever the temperature inside the vehicle reaches or drops below the preprogrammed temperature level. The system will monitor the air temperature every 3 hours and will only start the engine during extreme cold temperatures.

WARNING! Be certain that the vehicle is outdoors before using this or any remote vehicle-starting device. A running engine produces dangerous carbon monoxide fumes, which can be harmful or fatal if prolonged exposure occurs. DO NOT remote start the vehicle if it is garaged.

Timer Start Operation:

1. Turn the ignition key on then off. Within 15 seconds
- 2-a. For 2-Way Transceiver: Spin up the ▲ switch to the page 5 and then press the "Timer Start" button. or
- 2-b. For Regular one-way Transmitter: Press the 🗑 button first, with 3 seconds press the * button.
3. The parking lights will flash and the siren will chirp 3 times indicating the timed start mode has been activated.



Daily Timer Start Operation: The feature is very useful for a driver who wants to run the vehicle at the same time the next day. **NOTE:** Before setting-up of the "Daily Timer Start", you should set your time

Engine start time (See the "Daily Start Timer" Setting on page 10)

1. Turn the ignition key ON then OFF. Within 15 seconds
2. Spin up the ▲ switch to the page 5 and then press the "Daily start" button.
3. The parking lights will flash and the siren will chirp 6 times indicating the daily timed start mode is activated.

Cancel the timer start: To cancel the timer start do one of the following:

1. Start the vehicle manually with the use of the ignition key.
2. Remote start the vehicle using your keychain RF transmitter.



F. TEMPERATURE CHECK

You can monitor the present indoor temperature of the passenger compartment through the OLED screen, before cooling or heating your vehicle.

Spin up the ▲ switch to the page 4 and then press the “Monitor TEMP.” button; the in-door temperature will be shown on the OLED screen. This reading may be higher than actual ambient temperature due to the greenhouse effect and is relative only to the inside vehicle temperature.



G. TO TURN OFF THE REMOTE START:

When the engine is running by remote start and you want to stop it,

1. Press * button on the remote transmitter while in remote start mode.
2. Move the optional remote start enable toggle switch to OFF position. (If installed)
3. Press the brake pedal.

The vehicle will shut down and turn off the parking light to indicate engine stopped.

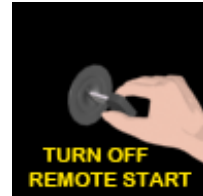

H. SHUT-DOWN INPUT FOR REMOTE STARTER:

If any of the following conditions exist while the system is operating, the engine will not start or will shut down immediately:

1. The hood is opened.
2. The brake pedal is pressed.
3. Engine is over-revved. {"Tachometer checking type" only}
4. The pre-programmed run time (5 /10 /20 / 30 minutes) has elapsed.
5. Press * button on the remote transmitter while in remote start mode.
6. Move the optional remote start enable toggle switch to OFF position. (If installed)
7. The vehicle refused to start running after {3} unsuccessful attempts.

I. DISABLING THE REMOTE START SYSTEM: (If installed)

This feature allows your system's remote start unit to be temporarily disabled to prevent the vehicle from being remote started accidentally. This feature is useful if the vehicle is being serviced or stored in an enclosed area. To disable the remote start, move the optional remote start enable toggle switch to the OFF position or place the unit in Valet Mode.

TEST MODE

In this test mode, the system can test the all of the trigger input. The installer can save time to test the sensitivity of the 2-stage shock sensor and optional sensor and without using the traditional arming/disarming procedures to test the sensors.

1. Press the 🗑️ button to disarm the system, within 10 seconds
2. Spin up the ▲ switch to the page 5
3. Press button 4



4. Press button 1 to test the Trigger and Safety Shutdown Input: One chirp to indicate your are in test mode

Trigger sensor	Siren short chirps
Zone 2 / Trunk trigger (H3/1 Dark Blue wire)	2
Zone 3 / Door trigger (H3/2 Dark Green or H3/3 Violet wire)	3

5. Press button 2 to test the Two Stage Shock Sensor: Two chirps to indicate your are in the two-stage shock sensor test mode.
 1. Activate the warn-away (first stage of the shock sensor); system will emit a short chirp.
 2. Activate the full alarm (second stage of the shock sensor); system will emit a long chirp.
 3. Continue to test the shock sensor until you reach the proper sensitivity.

LIMITED LIFETIME WARRANTY PROVISIONS

(U.S. ,Continental U.S. and Canada Only)

1. Auto Page, Inc. WARRANTS that this new unit has been thoroughly inspected and tested at the factory prior to delivery. Your Auto Page equipment is guaranteed for "life" to the original purchaser/user of the equipment and the original vehicle in which it was installed by an authorized installer under the following conditions: If the product proves defective (according to Auto Page's testing) within the first year, the defective unit may be exchanged or repaired free of charge. "Proof of Purchase" (dated sales receipt) must accompany all warranty returns; **otherwise, your return will be rejected and sent back.** After one (1) year, the purchaser should ship the unit prepaid to Auto Page with a money order in the amount of \$30.00 to cover shipping and handling charges. **Note:** The product needs to be registered online at time of installation. www.autopageusa.com
2. This WARRANTY will be considered void if the equipment has been misused, neglected, improperly serviced or installed, altered, dropped or damaged by water, contrary to the Auto Page OPERATIONS MANUAL. Or, if used with accessories not approved by Auto Page, which may have contributed to the defect. **See note below regarding product installation**.**
3. The purchaser's remedies under this WARRANTY shall be limited to the repair or replacement of electronic components only. **THE FOLLOWING IS NOT COVERED:** Damages or deterioration to cases, batteries, covers and cabinets; the cost of repairs, replacement and labor of which shall be borne by the purchaser even if occurring during the WARRANTY period.
4. Any equipment or parts which are claimed to be defective under this WARRANTY must be sent to the Auto Page Service center with "proof of purchase" at the purchaser's expense prior to such return, a Return Authorization Number should be obtained. Auto Page will return the equipment, charges prepaid. Warranty Service can be provided through the dealer where the equipment is originally purchased.
5. Any unexpired WARRANTY shall be applicable to equipment and parts in the possession of the original purchaser only.
6. THIS WARRANTY IS IN LIEU OF ANY AND ALL OTHER WARRANTIES, EXPRESSED OR IMPLIED, INCLUDING BUT NOT LIMITED TO ANY WARRANTY OF MERCHANTABILITY OR FITNESS FOR A PARTICULAR PURPOSE.
7. Auto Page shall not be liable, under the foregoing WARRANTIES or otherwise, for: Any personal injury of any kind to the purchaser, its employees or agents or anyone else whomsoever resulting directly or indirectly from the use or presence of the equipment or parts; Consequential damages of any kind; any inability of the purchaser to use the equipment.

****IMPORTANT NOTE:** Any damages to the alarm system resulting from an installation performed by anyone other than a professional installation technician authorized by a dealer of Auto Page will void the product's limited lifetime warranty.

Auto Page Warranty:

You must register your product online at <http://www.autopageusa.com> to receive any warranty service.

Please go to the *customer service* tab and select *product registration*.

It is the purchaser's responsibility to register this product for any future warranty service.

Warning: Some batteries may contain Perchlorate

What is Perchlorate? Perchlorate is both a naturally occurring and manmade contaminant increasingly found in groundwater, surface water and soil. Most perchlorate manufactured in the U.S. is used as an ingredient in solid fuel for rockets and missiles. In addition, perchlorate-based chemicals are also used in the construction of highway safety flares, fireworks, pyrotechnics, explosives, **common batteries**, and automobile restraint systems. Perchlorate contamination has been reported in at least 20 states. Perchlorate greatly impacts human health by interfering with iodide uptake into the thyroid gland. In adults, the thyroid gland helps regulate the metabolism by releasing hormones, while in children; the thyroid helps in proper development. Perchlorate is becoming a serious threat to human health and water resources.

“Perchlorate Material – Special handling may apply.”

For more information, go to <http://www.dtsc.ca.gov/hazardouswaste/perchlorate/>

[This page left blank intentionally]



960 Knox Street Unit B, Torrance, CA 90502
Tel: (310) 323-1800 or (800) 262-2527 www.autopageusa.com