

TACOMA

2009 Quick Reference Guide

2009 Tacoma

This *Quick Reference Guide* is a summary of basic vehicle operations. It contains brief descriptions of fundamental operations so you can locate and use the vehicle's main equipment quickly and easily.

The *Quick Reference Guide* is not intended as a substitute for the *Owner's Manual* located in your vehicle's glove box. We strongly encourage you to review the *Owner's Manual* and supplementary manuals so you will have a better understanding of your vehicle's capabilities and limitations.

Your dealership and the entire staff of Toyota Motor Sales, U.S.A., Inc. wish you many years of satisfied driving in your new Tacoma.

! A word about safe vehicle operations

This *Quick Reference Guide* is not a full description of Tacoma operations. Every Tacoma owner should review the *Owner's Manual* that accompanies this vehicle.

Pay special attention to the boxed information highlighted in color throughout the *Owner's Manual*. Each box contains safe operating instructions to help you avoid injury or equipment malfunction.

All information in this *Quick Reference Guide* is current at the time of printing. Toyota reserves the right to make changes at any time without notice.

INDEX

OVERVIEW

Engine maintenance	7
Fuel tank door and cap	6
Hood release	6
Indicator symbols	4-5
Instrument cluster	4
Instrument panel	2-3
Keyless entry	6

FEATURES/OPERATIONS

Accessory meter	15
Air Conditioning/Heating	16
Audio	14-15
Automatic Transmission	8
Clock	10
Cruise control	19
Door locks-Power	18
Four-wheel drive	9
Lights & turn signals	17
Light control-Instrument panel	8
Parking brake	13
Power outlets	13
Rear differential lock	16
Seat adjustments-Front	10
Seats-Folding rear	11
Seats-Head restraints	10
Telephone controls (Bluetooth®)	18
Tilt and telescopic steering wheel	9
“VSC OFF” button	19
Windows-Power	12
Windshield wipers & washers	12

SAFETY AND

EMERGENCY FEATURES

Doors-Child safety locks	21
Seat belts	20
Seat belts-Shoulder belt anchor	20
Spare tire & tools	21
Tire Pressure Monitoring (warning) System	20

Instrument panel

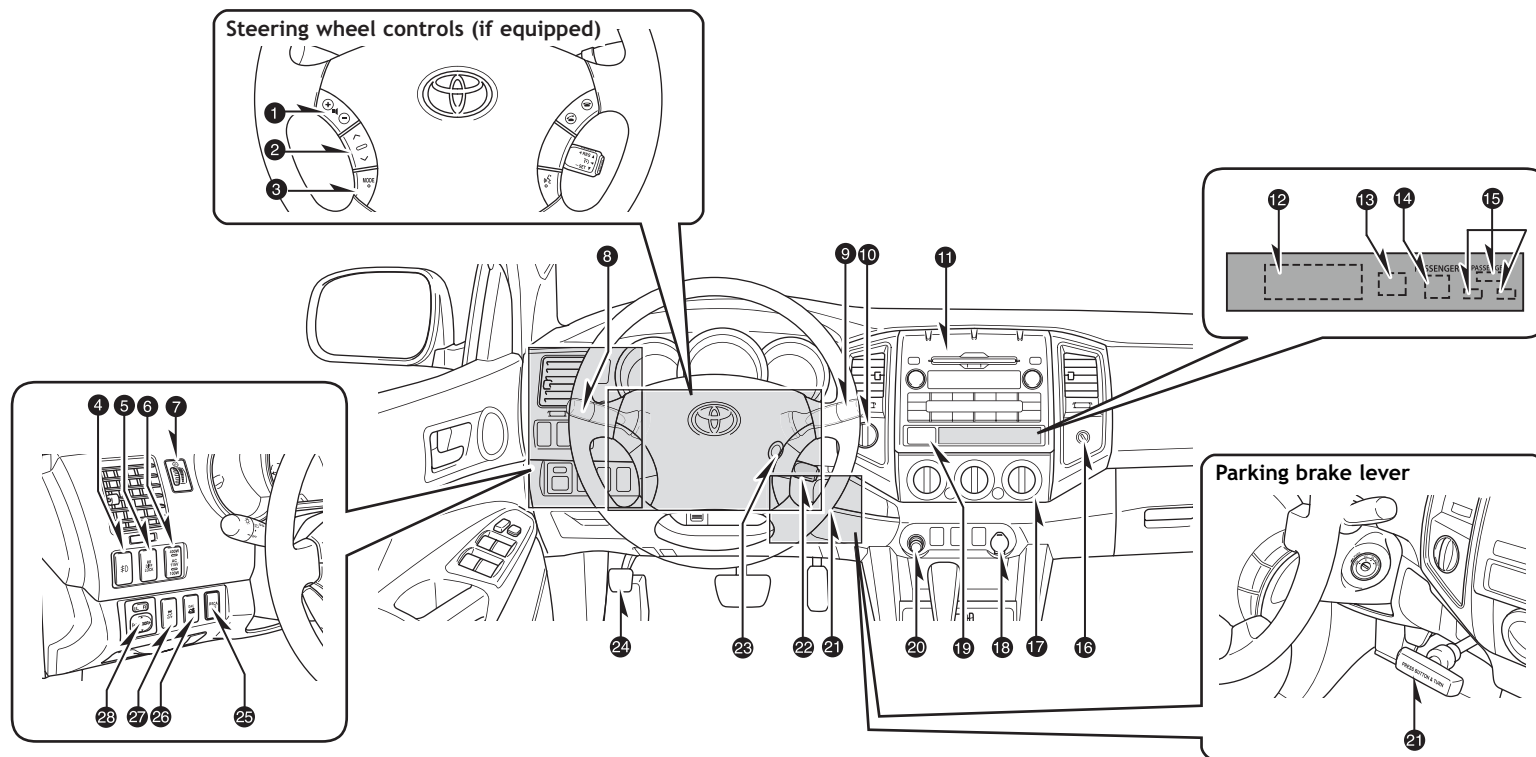

- ❶ Volume control buttons (for audio)
- ❷ “Λ V” buttons (for audio)
- ❸ “MODE” button (for audio)
- ❹ Front fog light switch¹
- ❺ Rear differential lock switch¹
- ❻ 115V AC Power outlet ON/OFF switch¹
- ❼ Instrument panel light control
- ❽ Headlight and turn signal controls
- ❾ Windshield wiper and washer controls
- ❿ Two-wheel/Four-wheel drive selector¹
- ⓫ Audio system
- ⓬ Clock
- ⓭ Theft deterrent system/Engine immobilizer indicator¹
- ⓮ Front passenger seat belt reminder
- ⓯ Front passenger occupant classification indicator¹ or front passenger airbag ON/OFF indicator¹

- ⓶ Front passenger airbag manual ON/OFF switch¹
- ⓷ Air Conditioning controls
- ⓸ 12V DC Power outlet
- ⓹ Emergency flasher button
- ⓺ 12V DC Power outlet/Cigarette lighter
- ⓻ Parking brake lever (stick type)²
- ⓼ Cruise control¹
- ⓽ Engine ignition switch
- ⓾ Parking brake pedal³
- ⓿ “RSCA OFF” (Roll Sensing Curtain shield Airbags OFF) switch
- ⓿ “DAC” (Downhill Assist Control) button¹ or clutch start cancel switch¹
- ⓿ “VSC OFF” (Vehicle Stability Control OFF) switch¹
- ⓿ Power rearview mirror control switches¹

¹ If equipped

² Manual Transmission only

³ Automatic Transmission only

Instrument cluster

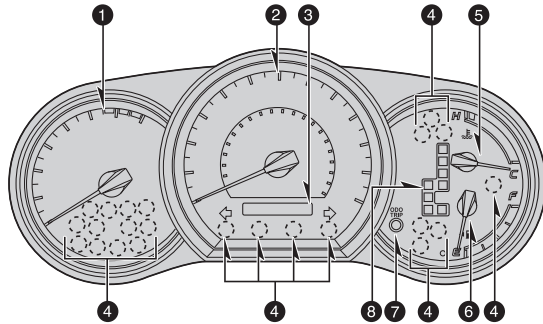

- 1 Tachometer
- 2 Speedometer
- 3 Odometer and two trip meters
- 4 Service indicator and reminder
- 5 Engine coolant temperature
- 6 Fuel gauge
- 7 Trip meter reset knob
- 8 Gear shift position indicator (if equipped)

Indicator symbols

- Brake system warning¹
- Driver/Front passenger seat belt reminder¹
- Charging system warning¹
- Front passenger occupant classification indicator/
Front passenger airbag ON/OFF indicator
- Low engine oil pressure warning¹
- Malfunction/Check Engine indicator¹
- Engine oil replacement reminder¹
- Open door warning¹

- Airbag SRS warning¹
- Automatic Transmission fluid temperature warning¹
- Low Tire Pressure Warning¹
- Theft deterrent/Engine immobilizer system indicator
- Roll Sensing Curtain shield Airbags OFF indicator²
- Headlight low beam indicator
- Headlight high beam indicator
- Turn signal indicator
- Automatic Transmission indicator (5-speed)/(4-speed)
- Four-wheel drive indicator³
- Low speed four-wheel drive indicator³
- Rear differential lock indicator⁴
- Slip indicator
- Vehicle Stability Control “OFF” indicator warning¹
- Downhill assist control system indicator
- AUTO Limited Slip Differential indicator
- Cruise control indicator⁵
- Anti-lock Brake System warning¹

¹ For details, refer to “Indicators and warning lights,” Section 2-2, 2009 Owner’s Manual.

² If this light flashes, refer to “SRS airbag,” Section 1-7-, 2009 Owner’s Manual.

³ If this light flashes, refer to “Four-wheel drive system,” Section 2-4, 2009 Owner’s Manual.

⁴ If this light flashes, refer to “Rear differential lock system,” Section 2-4, 2009 Owner’s Manual.

⁵ If this light flashes, refer to “Cruise control,” Section 2-4, 2009 Owner’s Manual.

Keyless entry (if equipped)

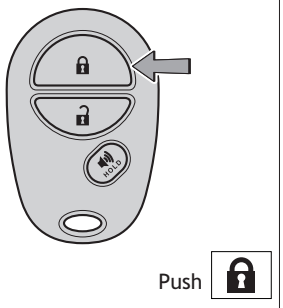
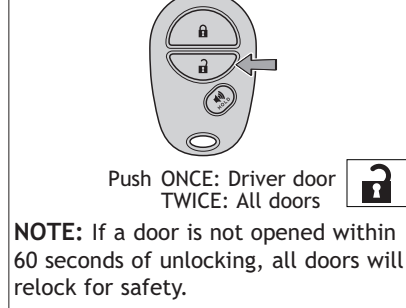
<p>Locking operation</p> 	<p>Unlocking operation</p> 
---	---

Panic button

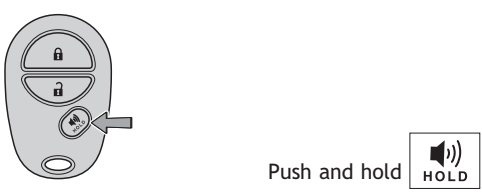

Fuel tank door and cap

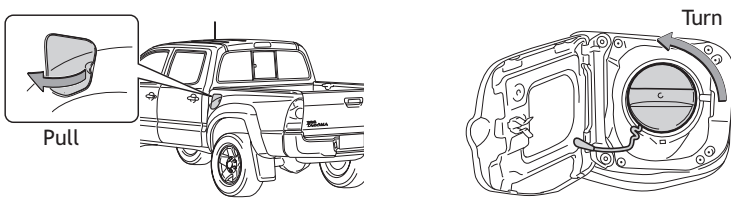

NOTE: Tighten until one click is heard. If the cap is not tightened enough, Check Engine “” indicator may illuminate.

Hood release

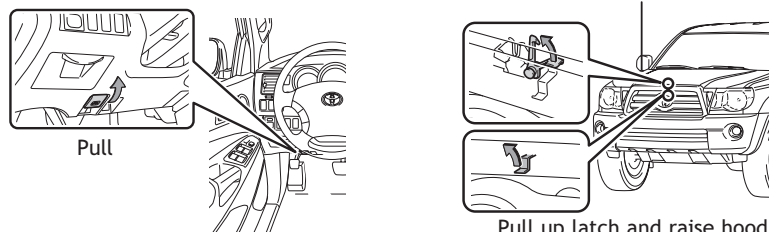

Engine maintenance

4 cylinder (2TR-FE) engine

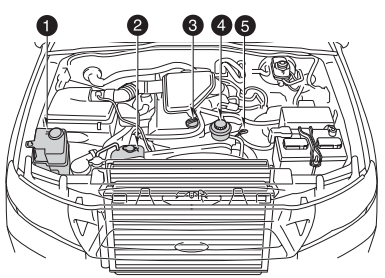

6 cylinder (1GR-FE) engine

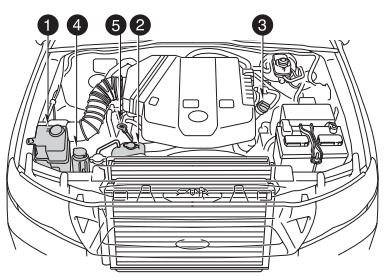

- ① Windshield washer fluid tank
- ② Engine coolant reservoir
- ③ Engine oil filler cap
- ④ Power steering fluid reservoir
- ⑤ Engine oil level dipstick

Note: Regularly scheduled maintenance, including oil changes, will help extend the life of your vehicle and maintain performance. Please refer to the “Owner’s Warranty Information Booklet,” “Scheduled Maintenance Guide” or “Owner’s Manual Supplement.”

FEATURES/OPERATIONS

Automatic Transmission (if equipped)

5-speed models

- P** Park*
- R** Reverse
- N** Neutral
- D** Drive
- 4** Fourth gear
- 3** Third gear
- 2** Second gear
- L** First gear

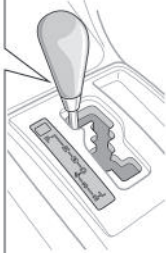

4-speed models

- P** Park*
- R** Reverse
- N** Neutral
- D** Drive
- 3** Third gear
- 2** Second gear
- L** First gear

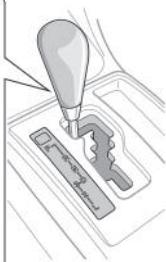

* The engine switch must be "ON" and the brake pedal depressed to shift from Park.

Downshifting increases power going uphill, or provides engine braking downhill. For best fuel economy during normal driving conditions, always drive with the shift lever in the "D" position.

Light control-Instrument panel

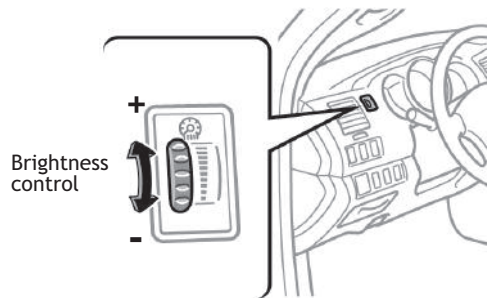

Four-wheel drive (if equipped)

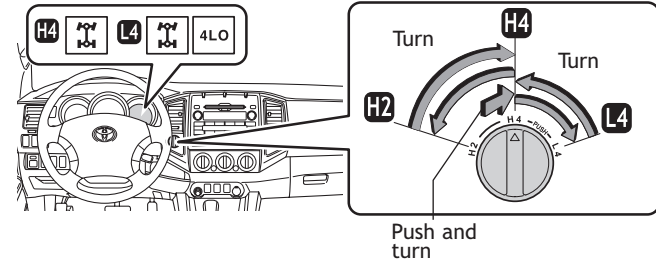

- H2** High speed (2WD)
- H4** High speed (4WD)
Shift when speed is below 62 mph.
- L4** Low speed (4WD)
Shift into neutral while stopped, or depress clutch pedal at speeds below 2 mph.

For best fuel economy and performance under normal driving conditions, keep in "H2" position.

Tilt and telescopic steering wheel

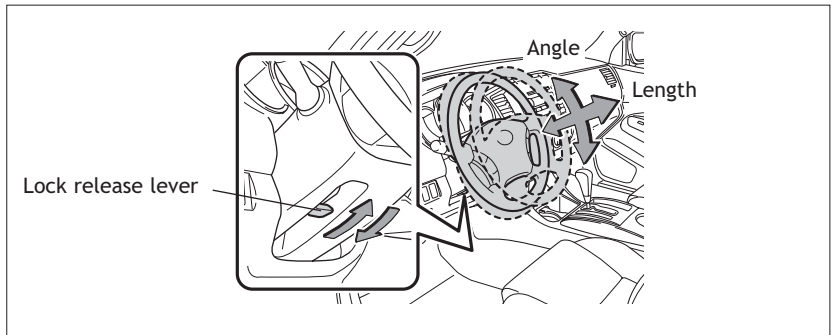

Hold wheel, push lever down, set angle and length, and return lever.

Note: Do not attempt to adjust while the vehicle is in motion.

Seat adjustments-Front

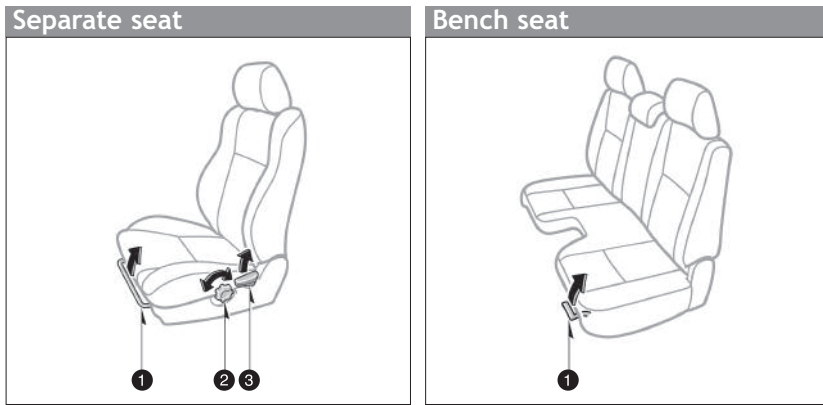

- ① Position
- ② Driver's seat lumbar support (if equipped)
- ③ Seatback angle

Seats-Head restraints

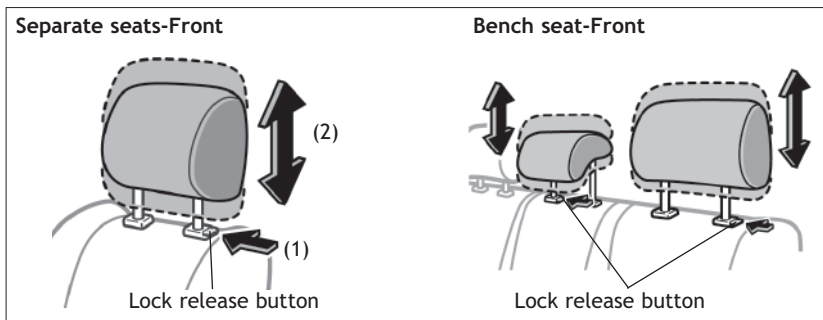

Clock

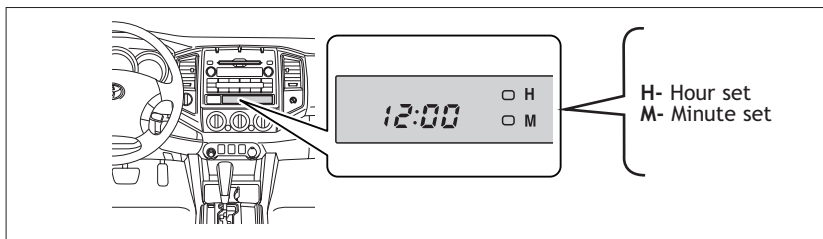

Seats-Folding rear

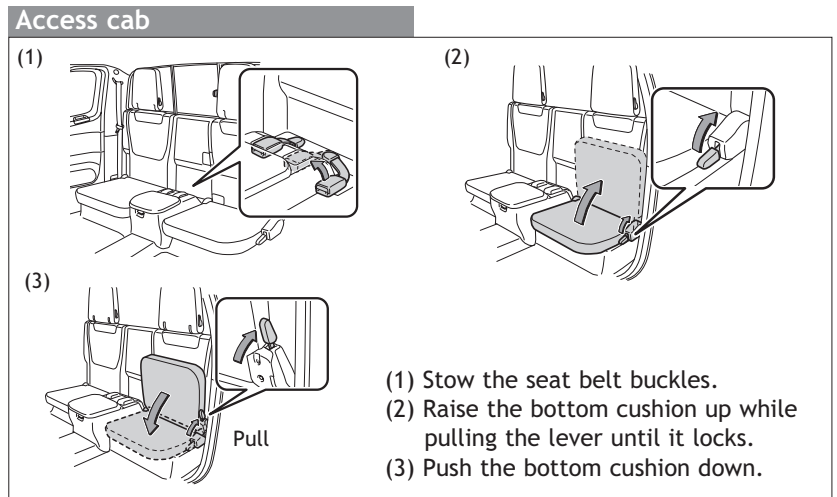

- (1) Stow the seat belt buckles.
- (2) Raise the bottom cushion up while pulling the lever until it locks.
- (3) Push the bottom cushion down.

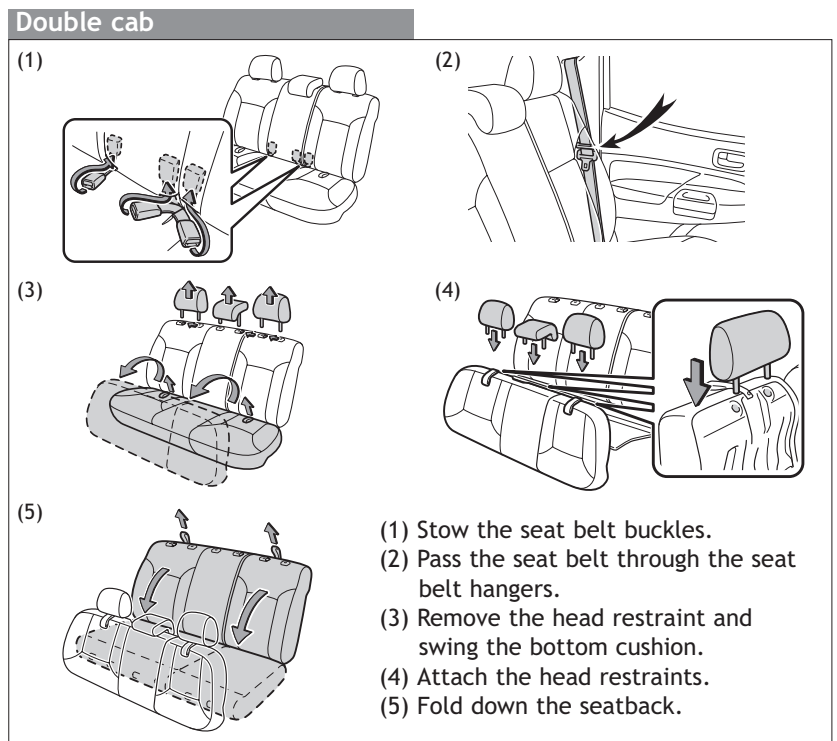

- (1) Stow the seat belt buckles.
- (2) Pass the seat belt through the seat belt hangers.
- (3) Remove the head restraint and swing the bottom cushion.
- (4) Attach the head restraints.
- (5) Fold down the seatback.

Windshield wipers & washers

With intermittent wiper

*** Intermittent windshield wiper interval adjustment**
Rotate up to increase interval, down to decrease interval.

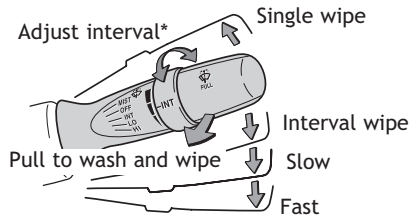

Without intermittent wiper

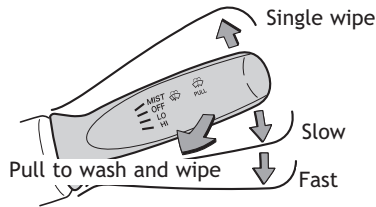

Windows-Power (if equipped)

Access cab models

Driver side



Double cab models

Driver side

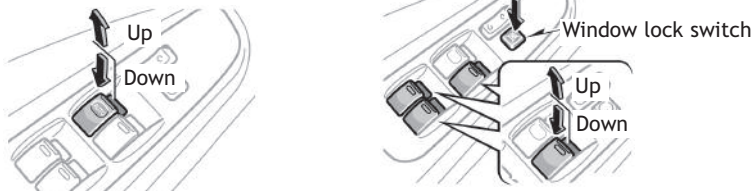

Automatic down operation (driver side only)

Push the switch completely down and release to fully open. To stop window midway, lightly pull up on the switch.

Window lock switch Deactivates all passenger windows. Driver's window remains operable.

Parking brake

Automatic Transmission



Manual Transmission

Set



Release

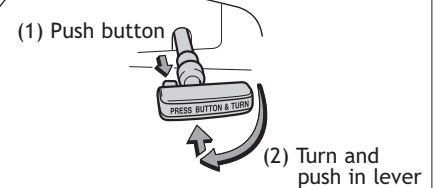

Power outlets

12V DC

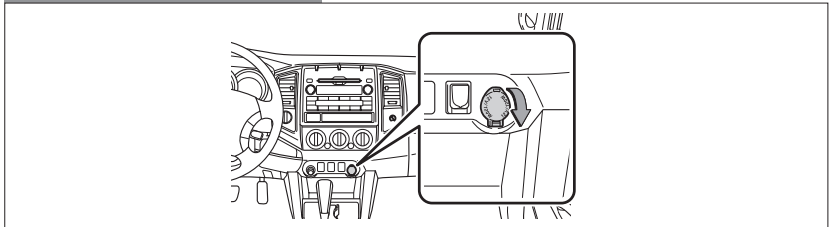

Key must be in the "ACC" or "ON" position to be used.

115V AC (if equipped)

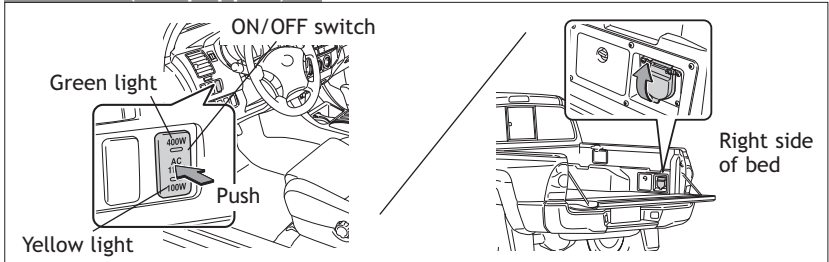

The engine must be running for use.

Yellow Light Only Max Capacity 115V AC/100W

Green & Yellow Lights Max Capacity 115V AC/400W

Refer to the *Owner's Manual* for more details.

Audio

Type 1

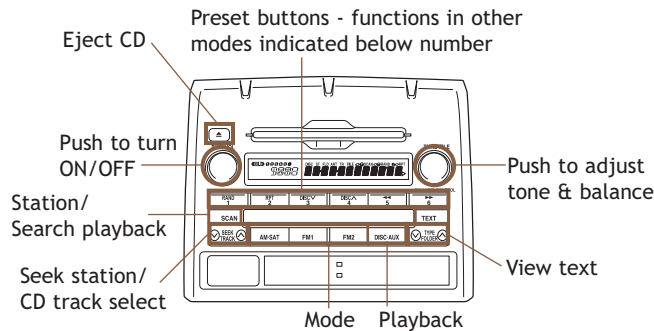

Type 2 additional functions

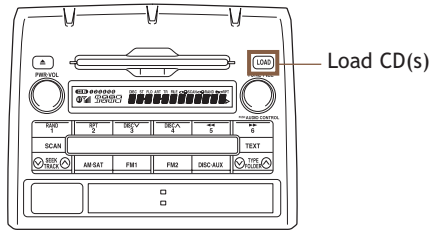

CD PLAYER

To scan tracks on a disc Push and hold "SCAN." Push again to hold selection.

CD changer (Type 2 only)

-To load one disc Push "LOAD" and insert one disc.
 -To load multiple discs Push and hold "LOAD" until you hear a beep. Insert one disc. Shutter will close and then re-open for next disc.

RADIO

To preset stations Tune in the desired station and hold down a preset button (1-6) until you hear a beep. Push desired preset button (1-6) to select.

To scan stations Push and hold "SCAN" to scan preset stations. Push again to hold selection.

Steering wheel switches (if equipped)

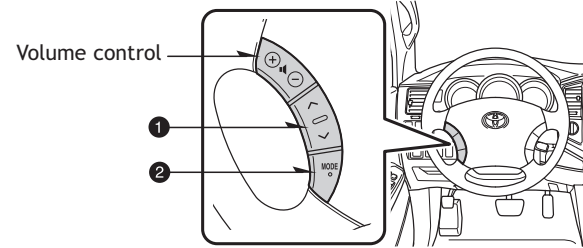

1 " ^ V "

-In radio mode

Push to select a preset station; push and hold to seek the next strong station.

-In CD mode

Push to skip up or down to the next/previous track.

2 "MODE"

Push to turn audio ON and select an audio mode. Push and hold to turn the audio system OFF.

AUX audio jack

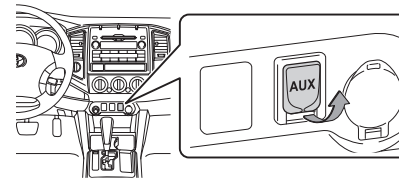

Push "DISK/AUX" button after inserting a mini plug into the AUX audio jack to listen to music from a portable audio device through the vehicle's speaker system.

Accessory meter (if equipped)

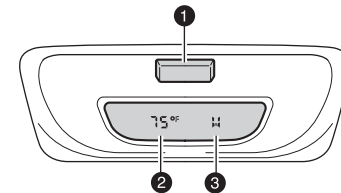

1 Display button

2 Outside temperature

3 Compass

Air Conditioning (if equipped)/Heating

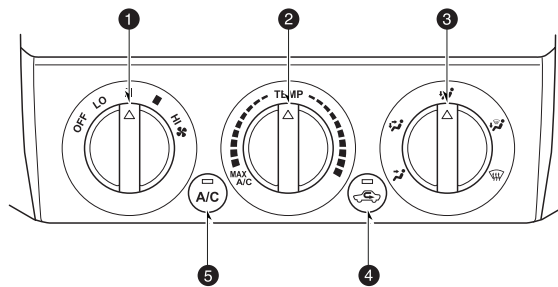

- ❶ Fan speed
- ❷ Temperature
- ❸ Airflow vent
In “” or “” mode, use fresh air (“” indicator OFF) to reduce window fogging.
- ❹ Fresh or recirculated cabin air
- ❺ Air Conditioning ON/OFF (if equipped)
Use fresh air to quickly cool interior, then change to recirculate for cooler air.

Rear differential lock (if equipped)

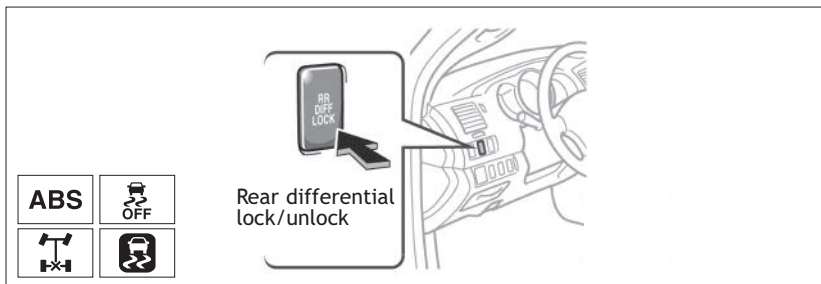

Use **ONLY** when wheel spinning occurs in a ditch, or on slippery or unpaved surfaces. **DO NOT USE THE REAR DIFFERENTIAL LOCK IN CONDITIONS OTHER THAN THOSE SPECIFIED IN THE OWNER'S MANUAL. UNLOCK THE DIFFERENTIAL ONCE THE VEHICLE MOVES OUT OF THE TROUBLE SPOT.**

Refer to your *Owner's Manual* for complete details on this system before attempting to use it.

Lights & turn signals

Headlights

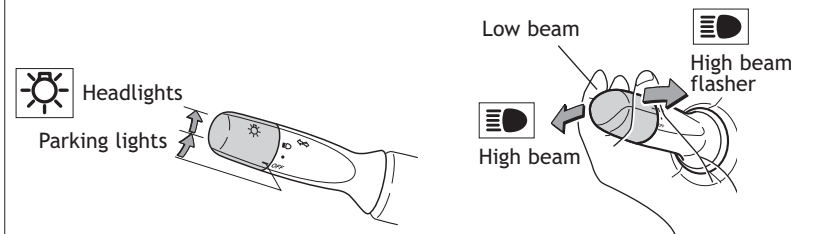

- Daytime Running Light system (if equipped)** Automatically turns on the turn signal lights at a reduced intensity.
- Automatic light cutoff system** Automatically turns lights off when driver's door is opened with the engine switch in the “ACC” or “LOCK” position.

Front fog lights (if equipped)

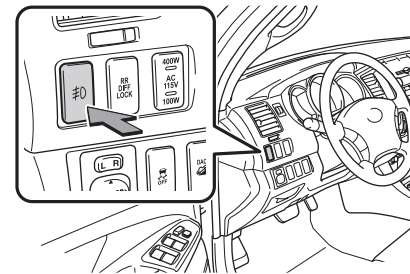

Front fog lights come on only when the headlights are on low beam.

Turn signals

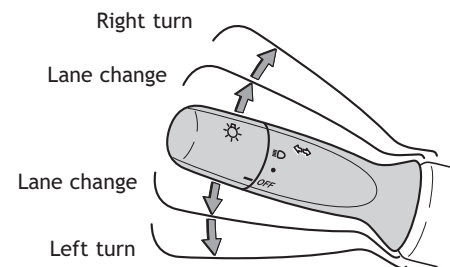

Telephone controls (Bluetooth®) (if equipped)

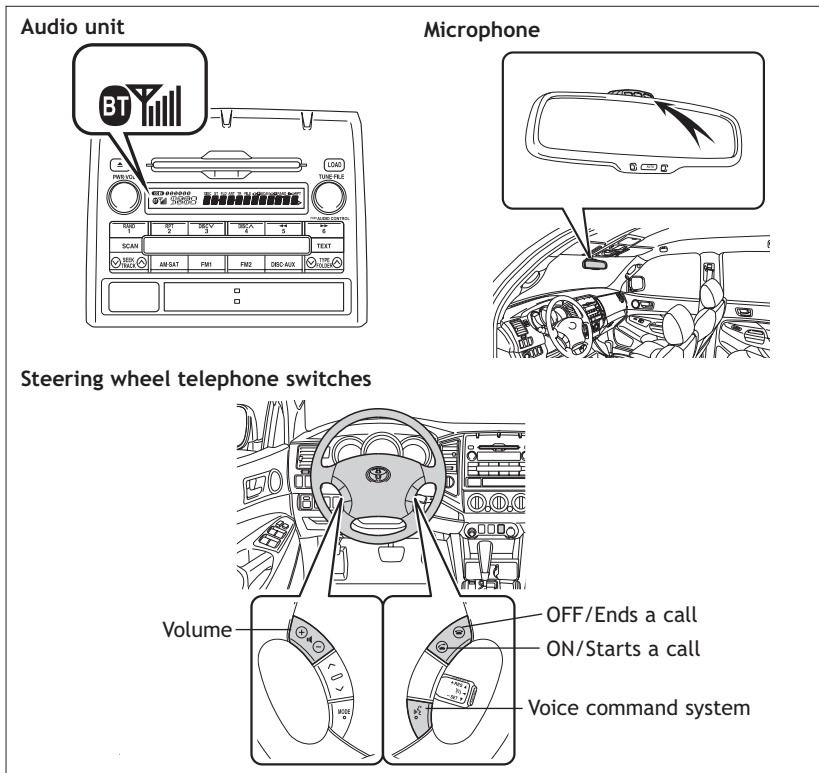

Bluetooth® technology allows you to place or receive calls without taking your hands from the steering wheel or using a cable to connect the telephone and the system.

Refer to “Using the hands-free phone system (for cellular phone),” Section 3-3 in the *Owner’s Manual* for more details.

Door locks-Power (if equipped)

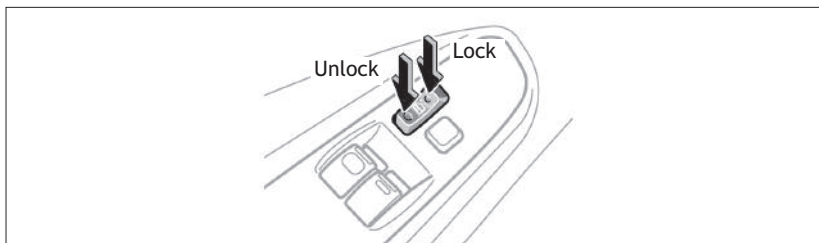

“VSC OFF” button

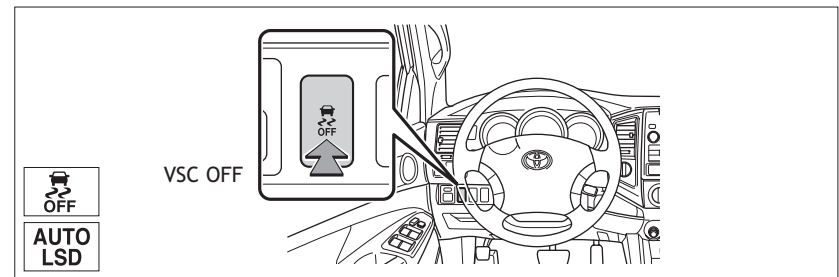

The “VSC OFF” button is used to switch between modes related to the TRAC, VSC and Auto LSD functions.

Refer to the *Owner’s Manual* for more information.

Cruise control (if equipped)

Turning system ON/OFF

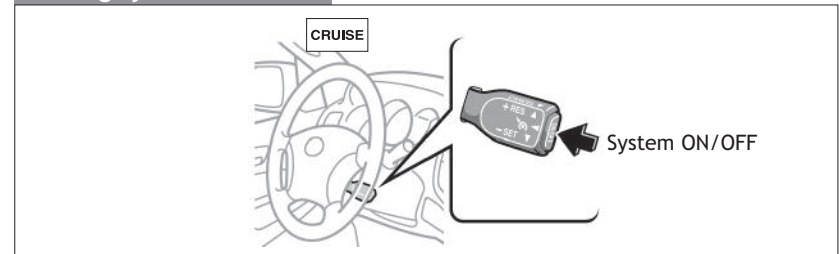

Functions

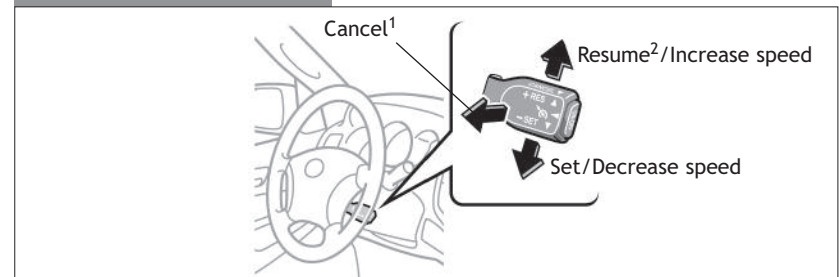

¹ The set speed may also be cancelled by depressing the brake pedal.

² The set speed may be resumed once vehicle speed exceeds 25 mph.

SAFETY AND EMERGENCY FEATURES

Seat belts

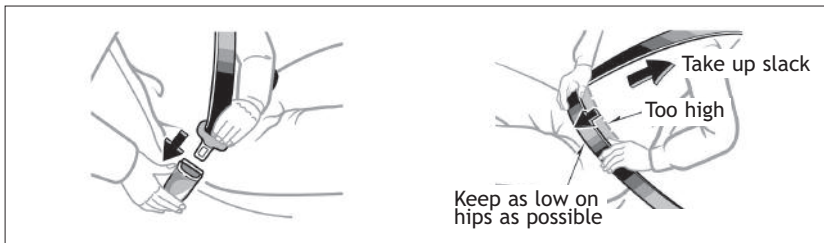

If belt is fully extended, then retracted even slightly, it cannot be re-extended beyond that point, unless fully retracted again. This feature is used to help hold child restraint systems securely.

To find more information about seat belts, and how to install a child restraint system, refer to the *Owner's Manual*.

Seat belts-Shoulder belt anchor

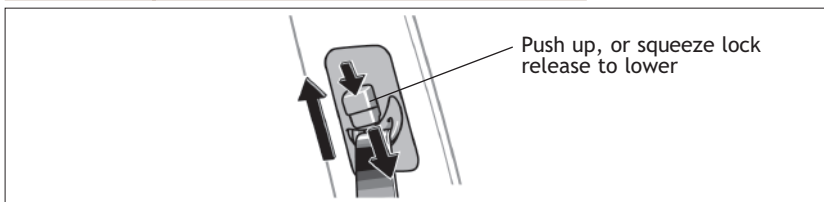

Tire Pressure Monitoring (warning) System

If tire pressure indicator light is on, check/adjust each tire.

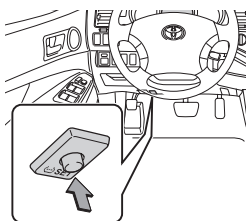

After adjusting tire pressures, or after tires have been rotated or replaced, turn the ignition switch to "ON" and press and hold the "SET" button until indicator blinks three times. Let the vehicle sit for a few minutes to allow initialization to complete.

Refer to the load label on the door jamb or the *Owner's Manual* for tire inflation specifications.

If the tire pressure indicator flashes for more than 60 seconds and then remains on, take the vehicle to your local Toyota dealer.

Doors-Child safety locks (double cab only)

Rear door

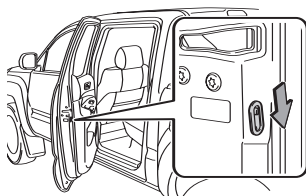

Moving the lever to “LOCK” will allow the door to be opened only from the outside.

Spare tire & tools

Tool location

Regular cab models
-behind the seatback

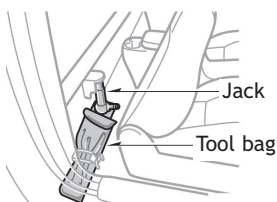

Double cab models
-under the rear seat

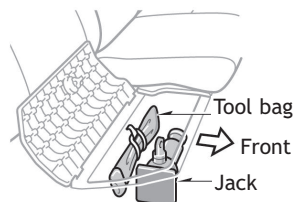

Access cab models
-under the rear seat

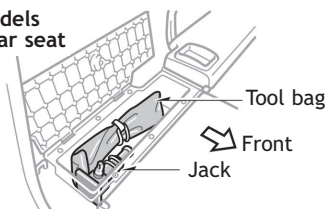

Removing the spare tire

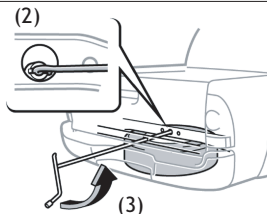
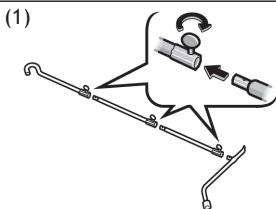

- (1) Assemble the jack handle.
- (2) Insert the jack handle end into the lowering screw.
- (3) Turn the jack handle counterclockwise.

Refer to the *Owner's Manual* for tire changing and jack positioning procedures.



Customer Experience Center
1-800-331-4331