



EN

FR

ES

## FM/AM CD Receiver

# CDA-9815 CDA-9813 CDA-9811

**MP3**



- **OWNER'S MANUAL**  
Please read before using this equipment.
- **MODE D'EMPLOI**  
Veuillez lire avant d'utiliser cet appareil.
- **MANUAL DE OPERACIÓN**  
Léalo antes de utilizar este equipo.

**ALPINE ELECTRONICS MARKETING, INC.**  
1-1-8 Nishi Gotanda,  
Shinagawa-ku,  
Tokyo 141-0031, Japan  
Phone 03-5496-8231

**ALPINE ELECTRONICS OF AMERICA, INC.**  
19145 Gramercy Place, Torrance,  
California 90501, U.S.A.  
Phone 1-800-ALPINE-1 (1-800-257-4631)

**ALPINE ELECTRONICS OF CANADA, INC.**  
7300 Warden Ave., Suite 203, Markham,  
Ontario L3R 9Z6, Canada  
Phone 1-800-ALPINE-1 (1-800-257-4631)

**ALPINE ELECTRONICS OF AUSTRALIA PTY. LTD.**  
6-8 Fiveways Boulevard Keysborough,  
Victoria 3173, Australia  
Phone 03-9769-0000

**ALPINE ELECTRONICS GmbH**  
Kreuzerkamp 7,  
40878 Ratingen, Germany  
Phone 02102-4550

**ALPINE ELECTRONICS OF U.K. LTD.**  
Alpine House  
Fletchamstead Highway, Coventry CV4 9TW, U.K.  
Phone 0870-33 33 763

**ALPINE ELECTRONICS FRANCE S.A.R.L.**  
(RCS PONTOISE B 338 101 280)  
98, Rue de la Belle Etoile, Z.I. Paris Nord II,  
B.P. 50016, 95945 Roissy Charles de Gaulle  
Cedex, France  
Phone 01-48638989

**ALPINE ITALIA S.p.A.**  
Viale C. Colombo 8, 20090 Trezzano Sul  
Naviglio (MI), Italy  
Phone 02-484781

**ALPINE ELECTRONICS DE ESPAÑA, S.A.**  
Portal de Gamarra 36, Pabellón, 32  
01013 Vitoria (Alava)-APDO 133, Spain  
Phone 945-283588

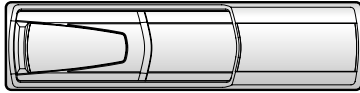

#### **CHA-S634**

- CD changer for CDA-9815/CDA-9813/CDA-9811.
- Changeur CD pour CDA-9815/CDA-9813/CDA-9811.
- Cambiador de CD para CDA-9815/CDA-9813/CDA-9811.

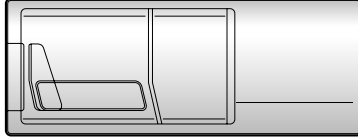

#### **CHA-1214**

- CD changer for CDA-9815/CDA-9813/CDA-9811.
- Changeur CD pour CDA-9815/CDA-9813/CDA-9811.
- Cambiador de CD para CDA-9815/CDA-9813/CDA-9811.

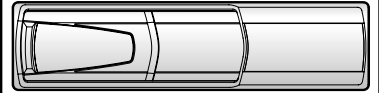

#### **CHM-S630**

## **Alpine CD Changers Give You More!**

***More musical selections, more versatility, more convenience.***

The CHA-S634 is a high-performance 6-disc changer with a new M DAC, CD-R/RW PLAY BACK, MP3 PLAY BACK and CD TEXT. The CHA-1214 Ai-NET model holds 12 discs, and the CHM-S630 M-Bus model is a super-compact 6-disc changer with a CD-R/RW PLAY BACK.

## **Changeurs de CD Alpine : vous avez le choix!**

***Plus de sélections musicales, plus de souplesse, plus de confort.***

Le modèle CHA-S634 est un changeur 6 disques ultra performant équipé des nouvelles fonctions M DAC, CD-R/RW PLAY BACK, MP3 PLAY BACK et CD TEXT. Le modèle CHA-1214 Ai-NET contient 12 disques. Le modèle CHM-S630 M-Bus est un changeur 6 disques super compact doté de la fonction CD-R/RW PLAY BACK.

## **¡Los cambiadores Alpine de CD le ofrecen más!**

***Más selecciones musicales, más versatilidad y más ventajas.***

CHA-S634 es un cambiador de seis discos de alto rendimiento con nuevo M DAC, CD-R/RW PLAY BACK, MP3 PLAY BACK y CD TEXT. El modelo CHA-1214 Ai-NET alberga 12 discos y el modelo CHM-S630 M-Bus es un cambiador de seis discos de tamaño reducido con un CD-R/RW PLAY BACK.

# Contents

## Operating Instructions



### WARNING

<b>WARNING</b> .....	<b>3</b>
<b>CAUTION</b> .....	<b>3</b>
<b>PRECAUTIONS</b> .....	<b>3</b>

## Getting Started

Turning Power On and Off .....	6
Initial System Start-Up .....	6
Setting Time .....	6
Opening and Closing the Movable Display .....	6
Display Tilt Adjustment .....	6
Adjusting Volume .....	7
Lowering Volume Quickly .....	7
Changing the Audio Level Display Pattern .....	7
Detaching and Attaching the Front Panel .....	7

## Radio

Changing the Radio Frequencies for each Country .....	8
Listening to Radio .....	8
Manual Storing of Station Presets .....	8
Automatic Memory of Station Presets .....	8
Tuning to Preset Stations .....	8
Station Title Search Function .....	9
Quick Search Function .....	9

## CD/MP3/WMA

Playback .....	9
Repeat Play .....	10
M.I.X. (Random Play) .....	10
Scanning Programs .....	11
File/Folder Search (concerning MP3/WMA) .....	11
Quick Search .....	11
About MP3/WMA .....	11

## Sound Setting

Adjusting Balance (Between Left and Right)/ Fader (Between Front and Rear)/Defeat .....	13
Setting the Bass Control (CDA-9811 only) ....	13
Setting the Treble Control (CDA-9811 only) ..	13
Setting the Bass Type (CDA-9811 only) .....	14
Adjusting the built-in Crossover (CDA-9811 only) .....	14
Equalizer Presets (CDA-9815/CDA-9813 only) .....	14
Adjusting and Storing the Equalizer Curve (CDA-9815/CDA-9813 only) .....	14
Recalling the Stored Equalizer Curve (CDA-9815/CDA-9813 only) .....	15
About the Crossover (CDA-9815/CDA-9813 only) .....	15
Adjusting and Storing the Crossover Settings (CDA-9815/CDA-9813 only) .....	16
Recalling the Stored Crossover Settings (CDA-9815/CDA-9813 only) .....	16
About Time Correction .....	17
Bass Focus .....	18
Adjusting and Storing the Time Correction (Storing available on CDA-9815 only) .....	19
Recalling the Stored Time Correction Settings (CDA-9815 only) .....	19
Setting the MX Mode .....	19

## Other Functions

Displaying the Title/Text .....	20
Titling Discs/Stations .....	21
Erasing Disc Title/Station Title .....	21
Displaying Time .....	21
Blackout Mode On and Off .....	21

*Windows Media, and the Windows logo are trademarks, or registered trademarks of Microsoft Corporation in the United States and/or other countries.*

## **i-Personalize™ Operation (CDA-9815 only)**

About i-Personalize™ .....	22
Data Downloading .....	22

## **SETUP**

### **Sound Customizing**

Switching the Tuner Mode .....	23
Subwoofer On and Off .....	23
Setting the Subwoofer Output (CDA-9815/ CDA-9813 only) .....	23
Sound (Beep) Guide Function .....	23

### **Visual Customizing**

Dimmer Control (CDA-9815/CDA-9813 only) .....	23
Scroll Setting .....	23
Scroll Type Setting (CDA-9815 only) .....	24
Switching the Character Font (CDA-9815 only) .....	24
Adjusting Display Contrast (CDA-9815 only) .....	24
Demonstration .....	24

### **MP3**

Playing MP3 Data .....	24
------------------------	----

### **External Device**

Turning Mute Mode On/Off .....	24
Setting the AUX Mode (V-Link) .....	24
Connecting to an External Amplifier .....	24
Setting Tone Defeat for External Devices .....	24

## **XM Radio (Optional)**

Receiving XM Channels with the XM Receiver (Optional) .....	25
Checking the XM Radio ID Number .....	25
Storing XM Channel Presets .....	25
Receiving Stored XM Channels .....	25
Channel/Category Search Function .....	26
Quick Search Function .....	26
Changing the Display .....	26
Setting the Tuning Method .....	26
Setting the Auxiliary Data Field Display .....	26

## **MobileHub™ Link Operation (Optional)**

About MobileHub™ Link .....	27
Telephone Mode ON/OFF .....	27
Incoming Calls .....	27
Calling .....	28
SMS (Short Message Service) Operation .....	28

## **Changer (Optional)**

Controlling CD Changer (Optional) .....	29
Playing MP3 Files with the CD Changer (Optional) .....	29
Multi-Changer Selection (Optional) .....	29

## **Remote Control**

Controls on Remote Control .....	30
Battery Replacement .....	31

## **Information**

In Case of Difficulty .....	31
Specifications .....	33

---

## **Installation and Connections**

Warning .....	34
Caution .....	34
Precautions .....	34
Installation .....	35
Connections for CDA-9811 .....	36
Connections for CDA-9815/CDA-9813 .....	38

## **LIMITED WARRANTY**

# Operating Instructions

## WARNING

### WARNING

This symbol means important instructions. Failure to heed them can result in serious injury or death.

#### **DO NOT OPERATE ANY FUNCTION THAT TAKES YOUR ATTENTION AWAY FROM SAFELY DRIVING YOUR VEHICLE.**

Any function that requires your prolonged attention should only be performed after coming to a complete stop. Always stop the vehicle in a safe location before performing these functions. Failure to do so may result in an accident.

#### **KEEP THE VOLUME AT A LEVEL WHERE YOU CAN STILL HEAR OUTSIDE NOISE WHILE DRIVING.**

Failure to do so may result in an accident.

#### **MINIMIZE DISPLAY VIEWING WHILE DRIVING.**

Viewing the display may distract the driver from looking ahead of the vehicle and cause an accident.

#### **DO NOT DISASSEMBLE OR ALTER.**

Doing so may result in an accident, fire or electric shock.

#### **USE ONLY IN CARS WITH A 12 VOLT NEGATIVE GROUND.**

(Check with your dealer if you are not sure.) Failure to do so may result in fire, etc.

#### **KEEP SMALL OBJECTS SUCH AS BATTERIES OUT OF THE REACH OF CHILDREN.**

Swallowing them may result in serious injury. If swallowed, consult a physician immediately.

#### **USE THE CORRECT AMPERE RATING WHEN REPLACING FUSES.**

Failure to do so may result in fire or electric shock.

#### **DO NOT BLOCK VENTS OR RADIATOR PANELS.**

Doing so may cause heat to build up inside and may result in fire.

#### **USE THIS PRODUCT FOR MOBILE 12V APPLICATIONS.**

Use for other than its designed application may result in fire, electric shock or other injury.

#### **DO NOT PLACE HANDS, FINGERS OR FOREIGN OBJECTS IN INSERTION SLOTS OR GAPS.**

Doing so may result in personal injury or damage to the product.

### CAUTION

This symbol means important instructions. Failure to heed them can result in injury or material property damage.

#### **HALT USE IMMEDIATELY IF A PROBLEM APPEARS.**

Failure to do so may cause personal injury or damage to the product. Return it to your authorized Alpine dealer or the nearest Alpine Service Center for repairing.

#### **DO NOT MIX NEW BATTERIES WITH OLD BATTERIES. INSERT WITH THE CORRECT BATTERY POLARITY.**

When inserting the batteries, be sure to observe proper polarity (+ and -) as instructed. Rupture or chemical leakage from the battery may cause fire or personal injury.

#### **KEEP FINGERS AWAY WHILE THE MOTORIZED FRONT PANEL OR MOVING MONITOR IS IN MOTION.**

Failure to do so may result in personal injury or damage to the product.

### PRECAUTIONS

#### **Temperature**

Be sure the temperature inside the vehicle is between +60°C (+140°F) and -10°C (+14°F) before turning your unit on.

#### **Moisture Condensation**

You may notice the CD playback sound wavering due to condensation. If this happens, remove the disc from the player and wait about an hour for the moisture to evaporate.

#### **Damaged Disc**

Do not attempt to play cracked, warped, or damaged discs. Playing a bad disc could severely damage the playback mechanism.

#### **Maintenance**

If you have problems, do not attempt to repair the unit yourself. Return it to your Alpine dealer or the nearest Alpine Service Station for servicing.

# PRECAUTIONS

## Never Attempt the Following

Do not grip or pull out the disc while it is being pulled back into the player by the automatic reloading mechanism.

Do not attempt to insert a disc into the unit when the unit power is off.

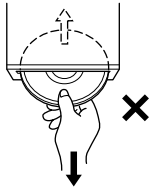

## Inserting Discs

Your player accepts only one disc at a time for playback. Do not attempt to load more than one disc.

Make sure the label side is facing up when you insert the disc. Your player will automatically eject any disc that is inserted incorrectly. If the player continues to eject a correctly inserted disc, push the RESET switch with a pointed object such as a ballpoint pen.

Playing a disc while driving on a very bumpy road may result in skips, but this will not scratch the disc or damage the player.

## New Discs

As a protective measure to prevent the CD from jamming, the CD player will automatically eject discs with irregular surfaces or inserted incorrectly. When a new disc is inserted into the player and ejected after initial loading, using your finger, feel around the inside of the centre hole and outside edge of the disc. If you feel any small bumps or irregularities, this could inhibit proper loading of the disc. To remove the bumps, rub the inside edge of the hole and outside edge of the disc with a ballpoint pen or other such instrument, then insert the disc again.

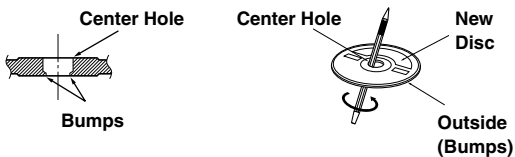

## Irregular Shaped Discs

Be sure to use round shape discs only for this unit and never use any special shape discs.

Use of special shape discs may cause damage to the mechanism.



## Installation Location

Make sure the CDA-9815/CDA-9813/CDA-9811 will not be installed in a location subjected to:

- Direct sun and heat
- High humidity and water
- Excessive dust
- Excessive vibrations

## Correct Handling

Do not drop the disc while handling. Hold the disc so you will not leave fingerprints on the surface. Do not affix tape, paper, or gummed labels to the disc. Do not write on the disc.



INCORRECT

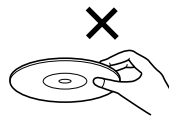

CORRECT



CORRECT



## Disc Cleaning

Fingerprints, dust, or soil on the surface of the disc could cause the CD player to skip. For routine cleaning, wipe the playing surface with a clean, soft cloth from the centre of the disc to the outer edge. If the surface is heavily soiled, dampen a clean, soft cloth in a solution of mild neutral detergent before cleaning the disc.



## Disc Accessories

There are various accessories available on the market for protecting the disc surface and improving sound quality. However, most of them will influence the thickness and/or diameter of the disc. Using such accessories can cause the disc to be out of standard specifications and may create operational problems. We recommend not using these accessories on discs played in Alpine CD players.

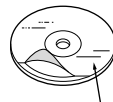

Transparent Sheet

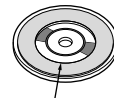

Disc Stabilizer

## On handling Compact Discs (CD/CD-R/CD-RW)

- Do not touch the surface.
- Do not expose the disc to direct sunlight.
- Do not affix stickers or labels and do not write on the surface.
- Clean the disc when it is dusty.
- Make sure that there are no bumps around the disc.
- Do not use commercially available disc accessories.

**Do not leave the disc in the car or the unit for a long time. Never expose the disc to direct sunlight.** Heat and humidity may damage the CD and you may not be able to play it again.

## To customers using CD-R/CD-RW

- If a CD-R/CD-RW cannot be played back, make sure the last recording session was closed (finalized).
- Finalize the CD-R/CD-RW if necessary, and attempt playback again.

## About discs that can be used.

Use only compact discs with the label side showing the CD logo marks below.



If you use unspecified compact discs, correct performance cannot be guaranteed.

You can play CD-Rs (CD-Recordable)/CD-RWs (CD-ReWritable) for audio use on this unit. You can also play CD-Rs/CD-RWs containing MP3/WMA formatted audio files.

- Some of the following CDs may not play on this unit: Flawed CDs, CDs with fingerprints, CDs exposed to extreme temperatures or sunlight (e.g., left in the car or this unit), CDs recorded under unstable conditions, CDs on which a recording failed or a re-recording was attempted, copy-protected CDs which do not conform to the audio CD industry standard.
- Use discs with MP3/WMA files written in a format compatible with this unit. For details, see page 11-12.

## About the alphanumeric display of CDA-9813/CDA-9811.

- All English lower case characters are displayed as upper case on this unit.
- The alphanumeric display in the following table shows alphanumeric characters/numbers that may be difficult to distinguish.

Alphanumeric	0	2	5	6	8	A	B	D
Display	0	2	5	6	8	A	B	D
Alphanumeric	G	H	K	M	Q	R	S	Z
Display	G	H	K	M	Q	R	S	Z

# Getting Started

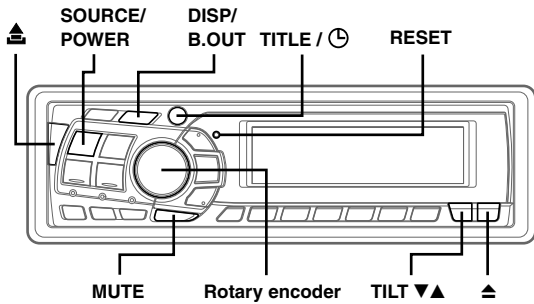

## Turning Power On and Off

Press **SOURCE/POWER** to turn on the unit.

- The unit can be turned on by pressing any other button except eject ▲ and **TITLE / ⏸**.

The volume level gradually increases to the previous level you were listening to before the unit was turned off.

Press and hold **SOURCE/POWER** for at least 3 seconds to turn off the unit.

- The first time power is turned on, the volume will start from level 12.

## Initial System Start-Up

Be sure to press the **RESET** switch when using the unit for the first time, after installing the CD changer, after changing the car battery, etc.

- 1 Turn off the unit power.
- 2 Press **RESET** with a ball-point pen or similar pointed object.

## Setting Time

- 1 Press **TITLE / ⏸** repeatedly until the time is displayed.  
For details, see "Displaying the Title/Text" (page 20).
  - 2 Press and hold **TITLE / ⏸** for at least 3 seconds while the time is displayed.  
The time indication will blink.
  - 3 Turn the **Rotary encoder** to adjust the hours.
  - 4 When the hour has been adjusted, press the **Rotary encoder**.
  - 5 Turn the **Rotary encoder** to adjust the minutes while the time indication is blinking.  
The time is automatically set 5 seconds after the minute adjustment. The time can also be manually set by pressing the **Rotary encoder**.
- To synchronize the clock to a time signal, press the **Rotary encoder** for at least 3 seconds after setting the "hour." Minutes will be indicated as 00. If you press the **Rotary encoder** for more than 3 seconds when the display shows over "30," hours will advance.

## Opening and Closing the Movable Display

Press ▲.

The movable display will open.

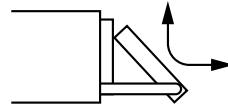

To close the movable display, press ▲ again.

The movable display will close.

- Do not apply shock to the movable display when it is open as it may result in malfunction of the unit.
- The display may be dim during low temperatures and immediately after turning on the power. The brightness will return to normal as time elapses.
- The display will stop at the set tilt angle when closing.

### Caution

Keep hands (or any other object) away from the display while it is opening or closing to avoid damage or injury. The back of the movable display will get very warm under normal operating conditions. This is not a malfunction. Do not touch.

## Display Tilt Adjustment

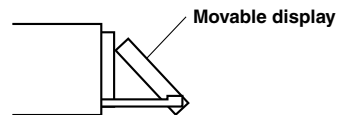

The movable display may be adjusted to 3 different tilt angles depending upon user preference.

Press **TILT ▼▲** to adjust the tilt angle of the movable display.

- The display will close a half minute after the ignition key is turned to the OFF position.
- The adjusted tilt angle of the display is stored in memory. There is no need to re-adjust the tilt angle when the power is turned back on.

### Caution

Keep hands (or any other object) away from the display while it is opening or closing to avoid damage or injury. The back of the movable display will get very warm under normal operating conditions. This is not a malfunction. Do not touch.



## Adjusting Volume

Turn the **Rotary encoder** until the desired sound is obtained.

## Lowering Volume Quickly

Activating the Audio Mute function will instantly lower the volume level by 20 dB.

Press **MUTE** to activate the **MUTE mode**.

The audio level will decrease by about 20 dB.

Pressing **MUTE** again will bring the audio back to its previous level.

## Changing the Audio Level Display Pattern

You can select the Audio Level display from three display patterns (For CDA-9811, only pattern 1 is displayed). You can also deactivate the display.

Press **DISP/B.OUT** to switch the display pattern.

**For CDA-9815/CDA-9813:**

AUDIO ADJUSTMENT → EQ ADJUSTMENT → X-OVER ADJUSTMENT → OFF → AUDIO ADJUSTMENT

The indicators show the value that is set in each mode as shown below.

	AUDIO ADJUSTMENT	EQ ADJUSTMENT	X-OVER ADJUSTMENT
Level Indicator	VOLUME	LEVEL	LEVEL
Width indicator	BALANCE	WIDTH	SLOPE
Frequency Indicator	FADER	FREQUENCY	FREQUENCY
Sub-W Indicator	SUB-W*	-	-

\*Only when SUB-W is set to ON

### AUDIO Adjustment Display

Example for CDA-9813

VOLUME : 18

BALANCE : L6

FADER : F6

SUB-W : 9dB

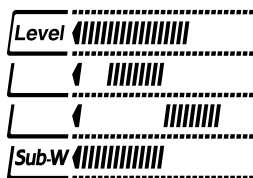

### EQ Adjustment Display

Example for CDA-9813

LEVEL : +2

WIDTH : 2

FREQUENCY: 200Hz

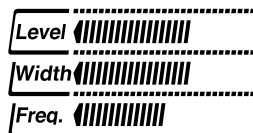

### X-OVER Adjustment Display

Example for CDA-9813

LEVEL : -7dB

SLOPE : 2 (-12dB/oct.)

FREQUENCY: 2k

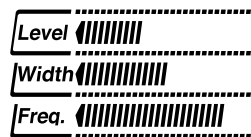

### For CDA-9811:

VOLUME SETTING → LEVEL INDICATOR → OFF → VOLUME SETTING

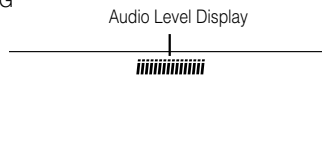

## Detaching and Attaching the Front Panel

### Detaching

- 1 Turn off the unit power.
- 2 Press  (Release) at the upper left side until the front panel pops out.
- 3 Grasp the left side of the front panel and pull it out.

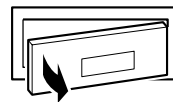

- The front panel may become hot in normal usage (especially the connector terminals on the back of the front panel.) This is not a malfunction.
- To protect the front panel, place it in the supplied carrying case.

### Attaching

- 1 Insert the right side of the front panel into the main unit. Align the groove on the front panel with the projections on the main unit.
- 2 Push the left side of the front panel until it locks firmly into the main unit.

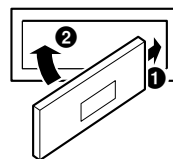

- Before attaching the front panel, make sure that there is no dirt or dust on the connector terminals and no foreign object between the front panel and the main unit.
- Attach the front panel carefully, holding the sides of the front panel to avoid pushing buttons by mistake.

# Radio

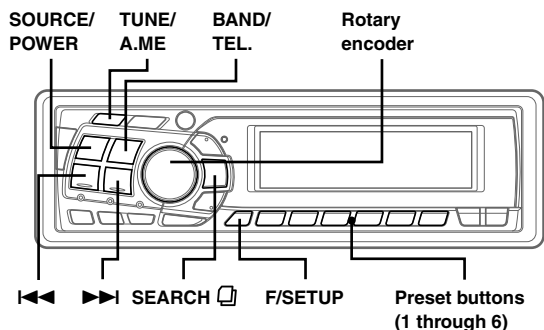

## Changing the Radio Frequencies for each Country

For customers not living in North America, change the radio frequencies as follows.

- 1 Press and hold **F/SETUP** for at least 3 seconds.
- 2 Select the "AREA" mode by pressing **◀◀** or **▶▶**.
- 3 Choose either AREA 1 or AREA 2 by pressing **BAND/TEL.**  
AREA 1: Radio frequencies for North America  
AREA 2: Other Radio frequencies
- 4 Press **F/SETUP** to return to normal mode.

• The stored radio stations will be cleared every time you change the setting.

## Listening to Radio

- 1 Press **SOURCE/POWER** until a radio frequency appears in the display.
- 2 Press **BAND/TEL.** repeatedly until the desired radio band is displayed.  
FM1 → FM2 → AM → FM1
- 3 Press **TUNE/A. ME** to select the tuning mode.

DX SEEK (Distance mode) → DX SEEK (Local mode) → DX SEEK (Manual mode) → DX SEEK

- Only portions underlined on the display may be lit.
- The initial mode is DX SEEK (Distance mode).

### Distance mode:

Both strong and weak stations will be automatically tuned in (Automatic Seek Tuning).

### Local mode:

Only strong stations will be automatically tuned in (Automatic Seek Tuning).

### Manual mode:

The frequency is manually tuned in steps (Manual tuning).

- 4 Press **◀◀** or **▶▶** to tune in the desired station.  
Holding down **◀◀** or **▶▶** will change the frequency continuously.

- The *ST* indicator appears on the display when a stereo FM station is tuned in.

## Manual Storing of Station Presets

- 1 Select the radio band and tune in a desired radio station you wish to store in the preset memory.
- 2 Press and hold any one of the **preset buttons (1 through 6)** that you want to store the station on for at least 2 seconds.  
The selected station is stored.  
The display shows the band, preset no. and station frequency memorized.

- A total of 18 stations can be stored in the preset memory (6 stations for each band; FM1, FM2 and AM).
- If you store a station in a preset memory which already has a station, the current station will be cleared and replaced with the new station.

## Automatic Memory of Station Presets



- 1 Press **BAND/TEL.** repeatedly until the desired radio band is displayed.
  - 2 Press and hold **TUNE/A. ME** for at least 2 seconds.  
The frequency on the display continues to change while the automatic memory is in progress. The tuner will automatically seek and store 6 strong stations in the selected band. They will be stored into buttons 1 to 6 in order of signal strength.  
When the automatic memory has been completed, the tuner goes to the station stored in preset location no. 1.
- If no stations are stored, the tuner will return to the original station you were listening to before the auto memory procedure began.

## Tuning to Preset Stations

- 1 Press **BAND/TEL.** repeatedly until the desired band is displayed.
- 2 Press any one of the station **preset buttons (1 through 6)** that has your desired radio station in memory.  
The display shows the band, preset number and frequency of the station selected.



## Station Title Search Function

If titles for radio stations are entered, you can search for a radio station from its title.

- 1 Press **SEARCH**  in Radio mode to switch to Title Search mode.  
The first title input blinks in the display.
  - 2 Select the desired title by turning the **Rotary encoder** within 10 seconds.
  - 3 Press the **Rotary encoder** to receive the frequency of the selected title.
- Search mode in Title Search mode is canceled by pressing and holding **SEARCH**  for at least 2 seconds.
  - If a station has no title, "NO TITLE" is displayed for 2 seconds.

## Quick Search Function

You can search for a radio station by its frequency.

- 1 Press and hold **SEARCH**  for at least 2 seconds in Radio mode to activate Quick Search mode.
  - 2 Turn the **Rotary encoder** within 10 seconds to select the desired frequency.
  - 3 Press the **Rotary encoder** to receive the selected frequency.
- Search mode in Quick Search mode is canceled by pressing and holding **SEARCH**  for at least 2 seconds.

## CD / MP3 / WMA

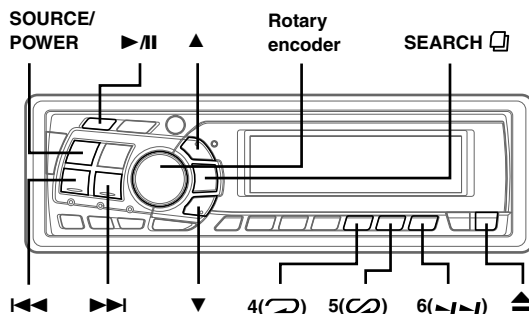

## Playback

- 1 Press .  
The movable display will open.
- 2 Insert a disc with the label side facing up.  
The disc will be pulled into the unit automatically.

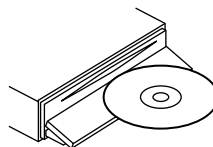

The movable display will close and playback will begin. When a disc is already inserted, press **SOURCE/POWER** to switch to the CD mode.

The mode will change every time the button is pressed.

TUNER → CD → CD CHANGER\* → TUNER

\* Only when the CD changer is connected

- 3 Press  or  to select the desired track (file).

**Returning to the beginning of the current track (file):**  
Press .



**Fast backward :**  
Press and hold .

**Advancing to the beginning of the next track (file) :**  
Press .

**Fast forward :**  
Press and hold .

- 4 To pause playback, press .  
Pressing  again will resume playback.

- 5 To eject the disc, press .

- Do not remove a CD during its eject cycle. Do not load more than one disc at a time. A malfunction may result from doing either.
- If the CD does not eject, press and hold  for at least 3 seconds with the movable display open.
- The CD-player can play discs containing audio data, MP3 data and WMA data.
- The MP3 indicator is lit during MP3 playback.
- The WMA indicator is lit during WMA playback.
- The track display for MP3/WMA data playback is the file numbers recorded on the disc.
- While playing back MP3/WMA, press  or  to move the folder up or down.

## Repeat Play

Press **4** (↻) to play back repeatedly the track being played.

The track (file) will be played repeatedly.

Press **4** (↻) again and select OFF to deactivate repeat play.

CD mode :

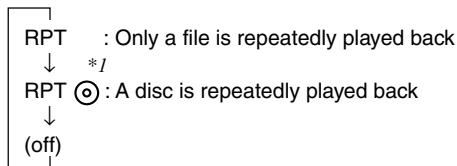

\*1 When a CD changer is connected

- If REPEAT is set to ON during M.I.X. play in CD changer mode, M.I.X. will apply to the current disc only.

MP3/WMA mode :

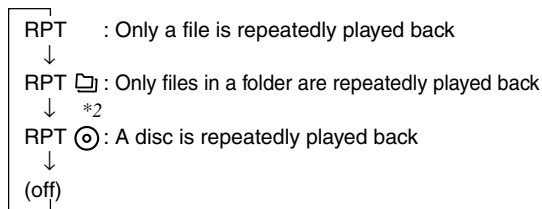

\*2 When an MP3 compatible CD changer is connected

- If a 6-disc CD changer or an MP3 compatible CD changer is connected:  
In CD changer mode, press **F/SETUP** to illuminate the "FUNC" indicator (only underlined portions of the "FUNC" indicator are illuminated for CDA-9811), and go to the step above within 5 seconds.
- If a 12-disc CD changer is connected:  
In CD changer mode, press **F/SETUP** twice to illuminate the "FUNC" indicator (only underlined portions of the "FUNC" indicator are illuminated for CDA-9811), and go to the step above within 5 seconds.

## M.I.X. (Random Play)

Press **5** (🎲) in the play or pause mode.

The tracks (files) on the disc will be played back in random sequence.

To cancel M.I.X. play, press **5** (🎲) again.

CD mode :

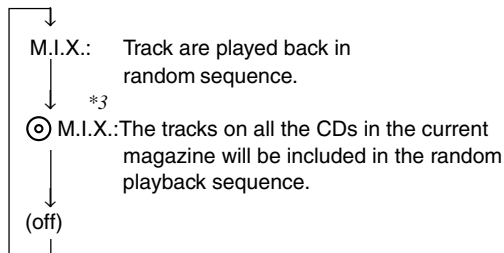

\*3 When a CD changer equipped with the All M.I.X. function is connected

- If M.I.X. is set to ON during RPT [M.I.X.] (REPEAT ALL) play in CD changer mode, M.I.X. will apply to the current disc only.

MP3/WMA mode :

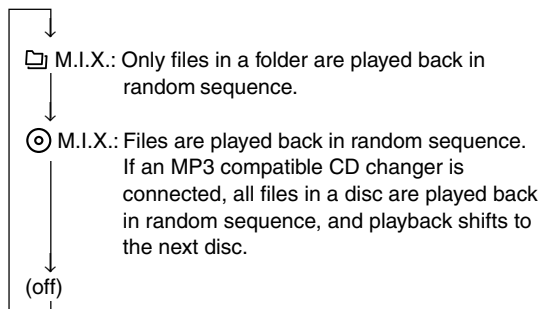

- If a 6-disc CD changer or an MP3 compatible CD changer is connected:  
In CD changer mode, press **F/SETUP** to illuminate the "FUNC" indicator (only underlined portions of the "FUNC" indicator are illuminated for CDA-9811), and go to the step above within 5 seconds.
- If a 12-disc CD changer is connected:  
In CD changer mode, press **F/SETUP** twice to illuminate the "FUNC" indicator (only underlined portions of the "FUNC" indicator are illuminated for CDA-9811), and go to the step above within 5 seconds.

## Scanning Programs

### Press 6 (▶|◀) to activate the Scan mode.

The first 10 seconds of each track (file) will be played back in succession.

To stop scanning, press 6 (▶|◀) and deactivate the Scan mode.



- If a 6-disc CD changer or an MP3 compatible CD changer is connected:  
In CD changer mode, press **F/SETUP** to illuminate the "FUNC" indicator (only underlined portions of the "FUNC" indicator are illuminated for CDA-9811), and go to the step above within 5 seconds.
- If a 12-disc CD changer is connected:  
In CD changer mode, press **F/SETUP** twice to illuminate the "FUNC" indicator (only underlined portions of the "FUNC" indicator are illuminated for CDA-9811), and go to the step above within 5 seconds.

## File/Folder Search (concerning MP3/WMA)

### 1 Press **SEARCH** to select File Search mode or Folder Search mode in MP3/WMA mode.



#### File Search mode

- 2 Press **▲** or **▼** to select another Folder.
- 3 Select the desired file by turning the **Rotary encoder** within 10 seconds.
- 4 Press the **Rotary encoder** to play back the selected file.

- File Search mode is canceled by pressing and holding **SEARCH**  for at least 2 seconds.
- While in File Search mode, press **SEARCH**  to switch to Folder Search mode.

#### Folder Search mode

- 2 Turn the **Rotary encoder** within 10 seconds to select the desired folder.
- 3 Press the **Rotary encoder** to play back the first file in the selected folder.

- Search mode is canceled by pressing and holding **SEARCH**  for at least 2 seconds in Folder Search mode.
- While in Folder Search mode, press **SEARCH**  to switch to File Search mode.
- "NO FILE" is displayed for 2 seconds if the folder that is selected by the Folder Search mode contains no files.
- "-----" is displayed for the root folder (display example: CDA-9811).

## Quick Search

You can search for tracks(files).

### 1 Press and hold **SEARCH** for at least 2 seconds in the CD/Changer/MP3/WMA mode to activate Quick Search mode.

### 2 Turn the **Rotary encoder** within 10 seconds to select a desired track(file).

The selected track is played back immediately.

- Search mode is canceled by pressing and holding **SEARCH**  for at least 2 seconds in Quick Search mode.

## About MP3/WMA

### CAUTION

Except for private use, duplicating audio data (including MP3/WMA data) or distributing, transferring, or copying it, whether for free or for a fee, without permission of the copyright holder is strictly prohibited by the Copyright Act and by international treaty.

### What is MP3?

MP3, whose official name is "MPEG Audio Layer 3," is a compression standard prescribed by the ISO, the International Standardization Organization and MPEG which is a joint activity institution of the IEC.

MP3 files contain compressed audio data. MP3 encoding is capable of compressing audio data at extremely high ratios, reducing the size of music files to as much as one-tenth their original size. This is achieved while still maintaining near CD quality. The MP3 format realizes such high compression ratios by eliminating the sounds that are either inaudible to the human ear or masked by other sounds.

### What is WMA?

WMA, or "Windows Media™ Audio," is compressed audio data.

WMA allows you to create music files and store them at higher ratios of compression than MP3 audio data (approx. half original size). This is achieved while still maintaining CD quality sound.

### Method for creating MP3/WMA files

Audio data is compressed by using MP3/WMA specified software. For details on creating MP3/WMA files, refer to the user's manual for that software.

MP3/WMA files that can be played back by this device have the file extension "mp3" / "wma". Files with no extension cannot be played back. (WMA ver. 7.1 and 8 are supported)

### Supported playback sampling rates and bit rates

#### MP3

Sampling rates: 48 kHz, 44.1 kHz, 32 kHz, 24 kHz, 22.05 kHz, 16 kHz, 12 kHz, 11.025 kHz, 8 kHz

Bit rates: 8 - 320 kbps

#### WMA

Sampling rates: 48 kHz, 44.1 kHz, 32 kHz, 24 kHz, 22.05 kHz

Bit rates: 32 - 192 kbps

Note that for sampling rates, this device's frame display (Page 20) may not display correctly.

This device may not play back correctly depending on sampling rates.

### ID3 tags/WMA tags

This device supports ID3 tag v1 and v2, and WMA tag. If tag data is in an MP3/WMA file, this device can display the title (track title), artist name, and album name ID3 tag/WMA tag data.

This device can only display single-byte alphanumeric characters (up to 30) and the underscore. For non-supported characters, "NO SUPPORT" ("NO SUPRT" for CDA-9811) is displayed.

### Producing MP3/WMA discs

MP3/WMA files are prepared, then written to a CD-R or CD-RW using CD-R writing software. A disc can hold up to 510 files/folders (including Root Folders).

### Media supported

The media that this device can play back are CD-ROMs, CD-Rs, and CD-RWs.

### Corresponding File Systems

This device supports discs formatted with ISO9660 Level 1 or Level 2.

Under the ISO9660 standard, there are some restrictions to remember.

The maximum nested folder depth is 8 (including the root directory). File/folder names are limited to 31 characters (including the extension), and are limited to 15 characters for WMA.

Valid characters for folder/file names are letters A-Z (all caps), numbers 0-9, and '\_' (underscore).

This device also can play back discs in Joliet, Romeo, etc., and other standards that conform to ISO9660. However, sometimes the file names, folder names, etc., are not displayed correctly.

### Formats supported

This device supports CD-ROM XA, Mixed Mode CD, Enhanced CD (CD-Extra) and Multi-Session.

This device cannot correctly play back discs recorded with Track At Once or packet writing.

### Order of tracks

The unit plays the files in the order that the writing software writes them. Therefore, the playing order may not be the same as the order you input. The playback order of the folders and files is as follows. However, the folder and file playback order differs from the folder no. and file no. indicated on the display.

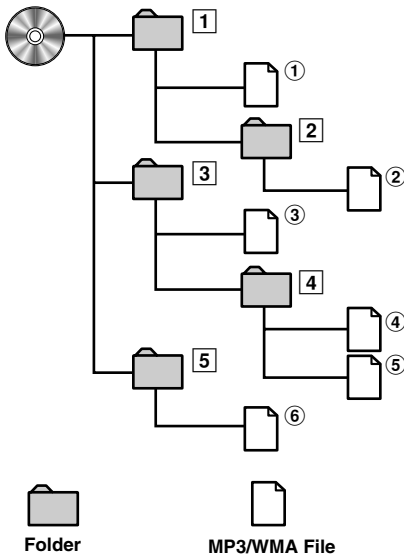

### Terminology

#### Bit rate

This is the "sound" compression rate specified for encoding. The higher the bit rate, the higher the sound quality, but also the larger the files.

#### Sampling rate

This value shows how many times per second the data is sampled (recorded). For example, music CDs use a sampling rate of 44.1 kHz, so the sound is sampled (recorded) 44,100 times per second. The higher the sampling rate, the higher the sound quality, but also the larger the volume of data.

#### Encoding

Converting music CDs, WAVE (AIFF) files, and other sound files into the specified audio compression format.

#### Tag

Song information such as track titles, artist names, album names, etc., written into MP3/WMA files.

MP3: ID3 tag

WMA: WMA tag

# Sound Setting

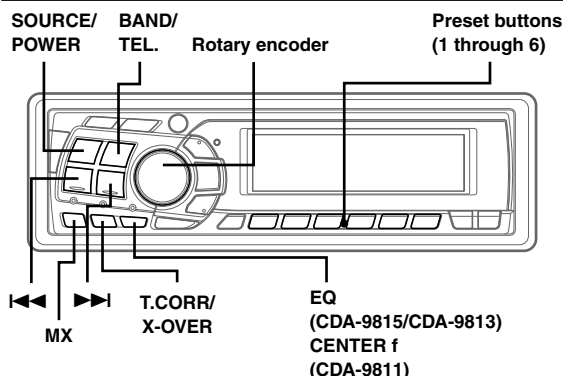

## Adjusting Balance (Between Left and Right)/ Fader (Between Front and Rear)/Defeat

### 1 Press Rotary encoder repeatedly to choose the desired mode.

Each press changes the modes as follows:

SUBWOOFER\*1 → BALANCE → FADER → DEFEAT → VOLUME → SUBWOOFER\*1

Subwoofer : 0 ~ +15  
 Balance : L15 ~ R15  
 Fader : R15 ~ F15  
 Defeat : ON/OFF  
 Volume : 0 ~ 35

Press ◀◀ or ▶▶ after selecting the Subwoofer mode, and the subwoofer output phase is toggled NORMAL (PHASE 0°) or REVERS (PHASE 180°).

- If the Rotary encoder is not pressed within 5 seconds after selecting the BALANCE, FADER, DEFEAT or SUBWOOFER mode, the unit automatically returns to normal mode.
- If you set the 2WAY/3WAY switch (page 38) to 3WAY, you cannot adjust the FADER mode on the CDA-9815/CDA-9813.

\*1 When the subwoofer mode is set to OFF, its level and phase cannot be adjusted.

### 2 Turn the Rotary encoder until the desired sound is obtained in each mode.

By setting Defeat ON, previously adjusted settings of BASS, TREBLE and EQ will return to the factory defaults and MX is turned off.

- Depending on the connected devices, some functions and display indications do not work.
- When you press DISP/B.OUT, you can switch the Level Indicator display to the AUDIO Adjustment display on the CDA-9815/CDA-9813 only. For details, see "Changing the Audio Level Display Pattern" (page 7).

## Setting the Bass Control (CDA-9811 only)

You can change the bass frequency emphasis to create your own tonal preference.

### 1 Press CENTER f to select the Bass (bass center frequency) Control mode.

BASS → TREBLE → normal mode → BASS

### 2-1\*2 Setting the bass center frequency:

Press ◀◀ or ▶▶ to select the desired bass center frequency.

60Hz ↔ 70Hz ↔ 80Hz ↔ 90Hz ↔ 100Hz ↔ 130Hz ↔ 150Hz ↔ 200Hz ↔ 60Hz

The displayed bass frequency is emphasized

### 2-2\*2 Setting the bass band width (Q-Factor):

Press BAND/TEL. to select the desired bass band width.

→ B. Width1 → B. Width2 → B. Width3 → B. Width4  
 (Narrow) ← ..... → (Wide)

Changes the boosted bass band width to wide or narrow. A wide setting will boost a wide range of frequencies above and below the center frequency. A narrower setting will boost only frequencies near the center frequency.

### 2-3 Setting the bass level:

Turn the Rotary encoder to select the desired bass level (-7~+7).

You can emphasize or weaken the bass frequency.

- If no buttons are pressed within 15 seconds, the bass control setting will be turned off automatically.
  - The bass level settings will be individually memorized for each source (FM, AM, XM, CD, etc.) until the setting is changed. The bass frequency and bass band width settings adjusted for one source are effective for all other sources (FM, AM, XM, CD etc.).
  - Depending on the connected devices, some functions and display indications do not work. However, bass level is still adjustable if an audio processor with the bass adjustment is connected.
  - This function is inoperable when DEFEAT is set to ON.
- \*2 Selecting any of the "Setting the Bass Type" (TYPE 1 through 3), temporarily replaces the custom settings you have made above.

## Setting the Treble Control (CDA-9811 only)

You can change the Treble Frequency emphasis to create your own tonal preference.

### 1 Press CENTER f to select the Treble (treble center frequency) Control mode.

BASS → TREBLE → normal mode → BASS

### 2-1 Setting the treble Center frequency:

Press ◀◀ or ▶▶ to select the desired treble center frequency.

10.0kHz ↔ 12.5kHz ↔ 15.0kHz ↔ 17.5kHz ↔ 10.0kHz

The displayed Treble frequency is emphasized.

### 2-2 Setting the treble level:

Turn the Rotary encoder to select the desired treble level (-7~+7).

You can emphasize the treble frequency.

- If no buttons are pressed within 15 seconds, the treble control setting will be turned off automatically.
- The treble level settings will be individually memorized for each source (FM, AM, XM, CD, etc.) until the setting is changed. The Treble frequency settings adjusted for one source are effective for all other sources (FM, AM, XM, CD, etc.).
- Depending on the connected devices, some functions and display indications do not work. However, treble level is still adjustable if an audio processor with the treble adjustment is connected.
- This function is inoperable when DEFEAT is set to ON.

## Setting the Bass Type (CDA-9811 only)

This function allows for 3 different bass type settings. Select the one that appeals to you the most.

- 1 Press and hold **CENTER f** for at least 2 seconds to set the bass type.
- 2 Press **◀◀** or **▶▶** within 15 seconds to select the desired type (1 through 3).  
TYPE 1 will sound best if you have a subwoofer in your system. Use TYPE 2 or 3 if you are using small diameter speakers.
- 3 Press and hold **CENTER f** for at least 2 seconds to return to normal mode.

- Bass center frequency and bass band width previously set are replaced when selecting TYPE 1 through 3. When bass type is set to OFF, your previous settings are restored.
- Bass type is not selectable when connected to an external audio processor.

## Adjusting the built-in Crossover (CDA-9811 only)

The High and Low Pass Filters on this unit can be adjusted to suit your personal taste.

- 1 Press and hold **T.CORR/X-OVER** for at least 2 seconds.  
HPF — <Press momentarily> → LPF\* — <Press momentarily> → normal mode — <Press and hold for 2 seconds> → HPF

\* When the subwoofer output of this unit is turned off, LPF and phase are deactivated.

- 2 Press **◀◀** or **▶▶** to select the desired setting.

### HPF (Setting the High Pass Filter):

FLAT (OFF) ↔ 80Hz ↔ 120Hz ↔ 160Hz

All frequencies above the selected cutoff are output.

### LPF (Setting the Low Pass Filter):

FLAT (OFF) ↔ 80Hz ↔ 120Hz ↔ 160Hz

All frequencies below the selected cutoff are output.  
(Only available when using the subwoofer output from this unit.)

- If no buttons are pressed within 15 seconds, the setup menu returns to normal mode.
- These functions are inoperative when an external, Ai-NET processor is connected.
- The Bass and Treble controls effectiveness in modifying the sound, depends on their settings and where the HPF and LPF are set.
- Except when the HPF and LPF is turned OFF, the subwoofer is in monaural mode.
- When the subwoofer is set to OFF, LPF mode and change of phase does not work.

## Equalizer Presets (CDA-9815/CDA-9813 only)

3 typical equalizer settings are preset at the factory for a variety of musical source material.

- 1 Press **EQ** and select the EQ mode.
- 2 Press either **◀◀** or **▶▶**.  
With each press of the button, the equalizer mode will display the selected equalizer characteristic.  
FLAT(OFF) → POPS → ROCK → NEWS → FLAT(OFF)  
FLAT : Flat frequency  
POPS : Emphasize midrange  
ROCK : Emphasize lows and highs  
NEWS : Boost midrange and suppress highs and lows

### Selecting directly

Select the desired button (1 through 4).

[1]: FLAT(OFF) [3]: ROCK  
[2]: POPS [4]: NEWS

- 3 Press **EQ** to return to normal mode.

- This function is inoperable when DEFEAT is set to ON (page 13).
- EQ mode is automatically canceled if no buttons are pressed within 15 seconds.
- When you press DISP/B.OUT, you can switch the Level Indicator display to the EQ Adjustment display. For details, see "Changing the Audio Level Display Pattern" (page 7).

## Adjusting and Storing the Equalizer Curve (CDA-9815/CDA-9813 only)

You can modify the Equalizer settings to create a response curve more appealing to your personal taste.

- 1 Press **EQ** to select the EQ mode.
  - 2 Press and hold **EQ** for at least 2 seconds.
  - 3 Press **BAND/TEL.** to select your desired frequency band.  
BAND1 → BAND2 → BAND3 → BAND4 → BAND5 → BAND1
  - 4 Press **◀◀** or **▶▶** to select your desired frequency.  
Adjustable frequency bands:  
20Hz to 20kHz (in 1/3 octave steps)
  - 5 Turn the **Rotary encoder** to adjust the level.
  - 6 Press **SOURCE/POWER** to select your desired band width (Q).  
Adjustable band width: 1, 2, 3.
- To store the adjusted curve**
- 1) Press and hold any one of the preset buttons (1 through 6) into which you wish to store the adjusted curve for at least 2 seconds.
- 7 To set another channel, repeat steps 3 to 6.
  - 8 After setting, press **EQ** to return to normal mode.

- The frequencies of adjacent bands cannot be adjusted within 4 steps.
- EQ mode is automatically canceled if no buttons are pressed within 15 seconds.
- This function is inoperable when DEFEAT is set to ON (page 13).



## Recalling the Stored Equalizer Curve (CDA-9815/CDA-9813 only)

- 1 Press **EQ** to select EQ mode.
- 2 Press and hold **EQ** for at least 2 seconds.
- 3 Press any one of the **preset buttons (1 through 6)** to activate your desired curve.
- 4 Press **EQ** to return to normal mode.

- EQ mode is automatically canceled if no operation is performed within 15 seconds.
- This function is inoperable when DEFEAT is set to ON (page 13).
- If you do not adjust the factory settings of (FLAT/POPS/ROCK/NEWS), the factory set display (FLAT/POPS/ROCK/NEWS) is shown preferentially.

## About the Crossover (CDA-9815/CDA-9813 only)

### Crossover:

This unit is equipped with an active crossover. The crossover limits the frequencies delivered to the outputs. Each channel is controlled independently. Thus, each speaker pair can be driven by the frequencies for which they have been optimally designed. The crossover adjusts the HPF (high pass filter) or LPF (low pass filter) of each band, and also the slope (how fast the filter rolls off the highs or lows).

Adjustments should be made according to the reproduction characteristics of the speakers. Depending on the speakers, a passive network may not be necessary. If you are unsure about this point, please consult your authorized Alpine dealer.

### 2 way mode

	Cut-off frequency (1/3 octave steps)		Slope		Level
	HPF	LPF	HPF	LPF	
<b>Low range speaker</b>	----	20 Hz - 200 Hz	----	FLAT, -6, -12, -18, -24 dB/oct	0 to -12 dB
<b>Rear high range speaker</b>	20 Hz - 200 Hz	----	FLAT, -6, -12, -18, -24 dB/oct	----	0 to -12 dB
<b>Front high range speaker</b>	20 Hz - 200 Hz	----	FLAT, -6, -12, -18, -24 dB/oct	----	0 to -12 dB

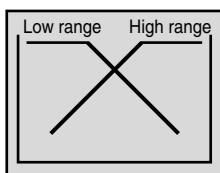

(Different from actual display)

### 3 way mode

	Cut-off frequency (1/3 octave steps)		Slope		Level
	HPF	LPF	HPF	LPF	
<b>Low range speaker</b>	----	20 Hz - 200 Hz	----	FLAT, -6, -12, -18, -24 dB/oct	0 to -12 dB
<b>Mid range speaker</b>	20 Hz - 200 Hz	20 Hz - 20 kHz	FLAT, -6, -12, -18, -24 dB/oct	FLAT, -6, -12, -18, -24 dB/oct	0 to -12 dB
<b>High range speaker</b>	1 kHz - 20 kHz	----	-6, -12, -18, -24 dB/oct	----	0 to -12 dB

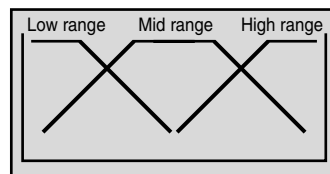

(Different from actual display)

### Level adjusting (0 to -12 dB)

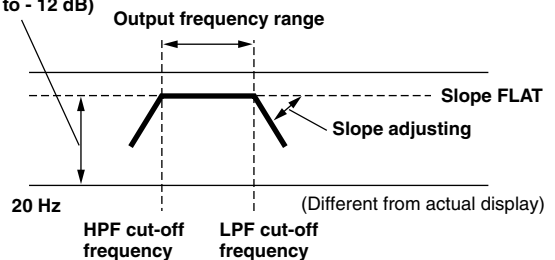

(Different from actual display)

- **HPF (high pass filter):** Cuts the lower frequencies and allows the higher frequencies to pass.
- **LPF (low pass filter):** Cuts the higher frequencies and allows the lower frequencies to pass.
- **Slope:** The level change (in dB) for a frequency change of one octave.
- The higher the slope value, the steeper the slope becomes.
- Adjust the slope to FLAT to bypass the HP or LP filters.
- Do not use a tweeter without the HPF on or set to a low frequency, as it may cause damage to the speaker due to the low frequency content.
- You cannot adjust the crossover frequency higher than the HPF or lower than the LPF.
- Adjustment should be made according to the recommended crossover frequency of the connected speakers. Determine the recommended crossover frequency of the speakers. Adjusting to a frequency range outside that recommended may cause damage to the speakers.  
For the recommended crossover frequencies of Alpine speakers, refer to the respective Owner's Manual.  
We are not responsible for damage or malfunction of speakers caused by using the crossover outside the recommended value.

## Adjusting and Storing the Crossover Settings (CDA-9815/CDA-9813 only)

Before performing the following procedures, refer to "About the Crossover"(page 15).

- 1 Press and hold **T.CORR/X-OVER** for at least 2 seconds.

### 2 WAY System

- 2 Press **BAND/TEL.** to select desired parameter.  
LOW (Subwoofer) → REAR → FRONT → LOW (Subwoofer)
- 3 Press **◀◀** or **▶▶** to select desired cut-off frequency point (cross over point).  
Adjustable frequency bands: 20Hz to 200Hz (in 1/3 octave steps)
- 4 Press **SOURCE/POWER** to select desired slope.  
Adjustable slope: 0 (FLAT (OFF)), 1 (-6 dB/oct.), 2 (-12 dB/oct.), 3 (-18 dB/oct.), 4 (-24 dB/oct.)

- 5 Turn the **Rotary encoder** to select the desired output level.  
Adjustable output level: -12 to 0 dB.

#### To store the adjusted contents

- 1 Press and hold any one of the preset buttons (1 through 6) for at least 2 seconds into which you wish to store the adjusted contents.
  - 6 For setting another channel, repeat the steps 2 to 5.
  - 7 After setting, press **T.CORR/X-OVER** to return to normal mode.
- Crossover mode is automatically canceled if no operation is performed within 15 seconds.

### 3 WAY System

- 2 Press **BAND/TEL.** to select desired parameter.  
LOW → MID-L → MID-H → HIGH (HI) → LOW
- 3 Press **◀◀** or **▶▶** to select desired cut-off frequency point (cross over point).  
Adjustable frequency bands:  
LOW : 20Hz to 200Hz (in 1/3 octave steps)  
MID-L : 20Hz to 200Hz (in 1/3 octave steps)  
MID-H : 20Hz to 20kHz (in 1/3 octave steps)  
HIGH : 1kHz to 20kHz (in 1/3 octave steps)
- 4 Press **SOURCE/POWER** to select the desired slope.  
Adjustable slope: 0 (FLAT (OFF))\* , 1 (-6 dB/oct.), 2 (-12 dB/oct.), 3 (-18 dB/oct.), 4 (-24 dB/oct.)  
\* FLAT cannot be set for the HIGH slope.

- 5 Turn the **Rotary encoder** to select the desired output level.

Adjustable output level: -12 to 0 dB.

#### To store the adjusted contents

- 1 Press and hold any one of the preset buttons (1 through 6) for at least 2 seconds into which you wish to store the adjusted contents.
- 6 For setting another channel, repeat the steps 2 to 5.
- 7 After setting, press **T.CORR/X-OVER** to return to normal mode.

- About the 2way/3way system

You can switch to 2way/3way system mode with the 2way/3way switch on the side of the unit (page 38).

When setting to "3 WAY" :

The unit can be operated in a 3 way system.

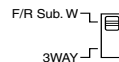

When setting to "F/R/Sub.W" :

The unit can be operated in a 2 way system.

- Crossover mode is automatically canceled if no operation is performed within 15 seconds.

## Recalling the Stored Crossover Settings (CDA-9815/CDA-9813 only)

- 1 Press and hold **T.CORR/X-OVER** for at least 2 seconds.
  - 2 Press any one of the **preset buttons (1 through 6)** that has your desired crossover settings in memory.
  - 3 Press **T.CORR/X-OVER** to return to normal mode.
- Crossover mode is automatically canceled if no operation is performed within 15 seconds.

## About Time Correction

The distance between the listener and the speakers in a car vary widely due to the complex speaker placement. This difference in the distances from the speakers to the listener creates a shift in the sounds image and frequency characteristics. This is caused by the time delay between the sound reaching the listener's right versus the left ear. To correct this, the CDA-9815/CDA-9813/CDA-9811 is able to delay the audio signal to the speakers closest to the listener. This effectively creates a perception of increased distance for those speakers. The listener can be placed at an equal distance between the left and right speakers for optimum staging. The adjustment will be made for each speaker in 0.1 ms steps.

### Example 1. Listening Position: Front Left Seat

**Adjust the time correction level of the front left speaker to a high value and the rear right to zero or a low value.**

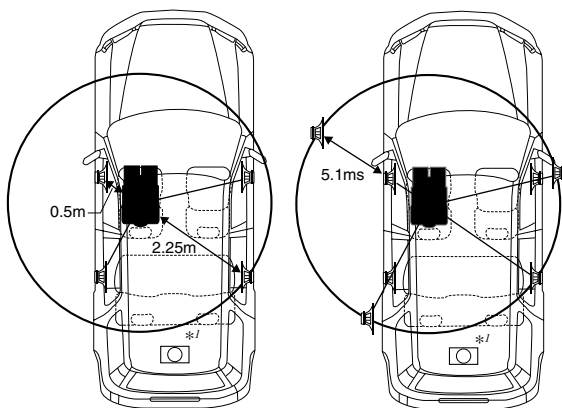

\*1 Subwoofer speaker.

CDA-9811 only

You cannot change the Time Correction value for the subwoofer, but you can set the subwoofer's apparent position to the front by adjusting the Time Correction value of the front and rear speakers. For details, refer to the “\*1” on page 18.

The sound is not balanced because the distance between the listening position and the various speakers is different.

The difference in distance between the front left speaker and the rear right speaker is 1.75 m (68-7/8”).

Here we calculate the time correction value for the front left speaker in the diagram on the above.

Conditions:

Farthest Speaker – listening position : 2.25 m (88-9/16”)

Front left speaker – listening position : 0.5 m (19-11/16”)

Calculation:  $L = 2.25 \text{ m} - 0.5 \text{ m} = 1.75 \text{ m} (68-7/8\text{'})$

Time correction =  $1.75 \div 343^{*2} \times 1000 = 5.1 \text{ (ms)}$

\*2 Speed of sound: 343 m/s (765 mph) at 20 °C

In other words, giving the front left speaker a time correction value of 5.1 ms makes it seem as if its distance from the listener is the same as the distance to the farthest speaker.

Time correction eliminates the differences in the time required for the sound to reach the listening position.

The time of the front left speaker is corrected by 5.1 ms so that its sound reaches the listening position at the same time as the sound of other speakers.

### Example 2. Listening Position: All Seats

Adjust the time correction level of each speaker to almost the same level.

- 1 Sit in the listening position (driver's seat, etc.) and measure the distance (in meters) between your head and the various speakers.**
- 2 Calculate the difference between the distance to the farthest speaker and the other speakers.**  
 $L = (\text{distance to farthest speaker}) - (\text{distance to other speakers})$
- 3 Divide the distances calculated for the speakers by the speed of sound (343 m/s (765 mph) at 20°C).**

These values are the time correction values for the different speakers.

## Bass Focus

The time difference between the front-rear/left-right speakers, can be adjusted at the same time. With an initial delay of 0.1 ms for each of the 0 to 99 steps, audible time correction can be done.

### 1 Press **T.CORR/X-OVER** to select the Bass Focus mode.

Bass Focus mode → Time correction mode → normal mode  
→ Bass Focus mode

### 2 Press **BAND/TEL.** to select the speakers to be adjusted (see below).

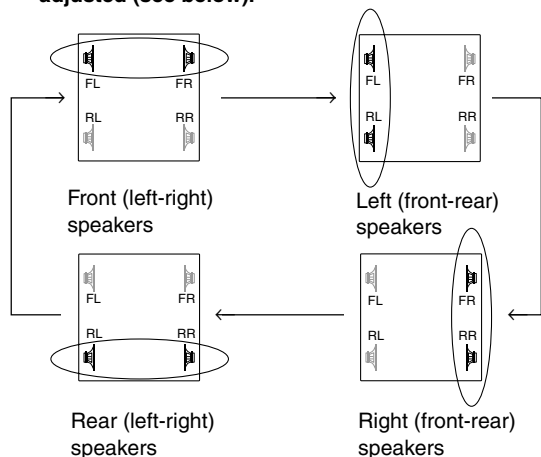

### 3 Turn the **Rotary encoder** to adjust the delay (see Time Difference Table).

### 4 To set another channel (speakers), repeat steps 2 and 3.

### 5 After setting, press and hold **T.CORR/X-OVER** for at least 2 seconds to return to normal mode.

- Any manual time correction adjustments will also affect corrections made in Bass Focus.
- Bass Focus mode is automatically canceled if no operation is performed within 15 seconds.

#### Example setting for steps 2 and 3

### (1) Press **BAND/TEL.** to select the front (left and right) speakers. Then turn the Rotary encoder to select 1.5 ms (Delay no. 15 in the table). The time difference is 1.5 ms for both front (left and right) speakers.

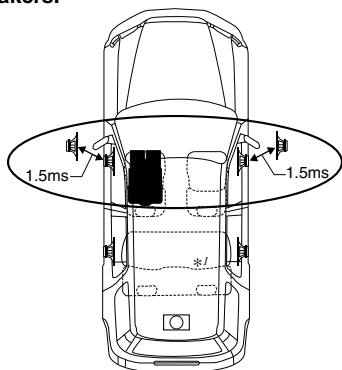

### (2) Press **BAND/TEL.** to select the left (front and rear) speakers. Then turn the Rotary encoder to select 1.5 ms (Delay no. 15 in the table). The time difference is 3.0 ms<sup>\*2</sup> for the front left speaker, and 1.5ms for the left rear speaker, creating the impression of an equal listening between the front left speaker and the other speakers.

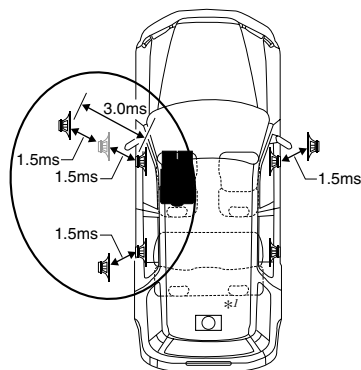

<sup>\*1</sup> Subwoofer speaker.  
CDA-9811 only

Delay (turn the **rotary encoder**) the audio signal to the front (left and right) speakers to make the apparent position of the subwoofer to be at the front. In doing this, the apparent position between the front (left and right) speakers and subwoofer will appear equal to the driver. After performing the above, you can change the positions of the left and right speakers by delaying the time.

<sup>\*2</sup> Because the time difference was already set to 1.5 ms for the front left speaker to begin with, the additional correction of 1.5 ms makes the total time difference of the front left speaker 3.0 ms.

Time Difference Table

Delay Number	Time Difference (ms)	Delay Number	Time Difference (ms)	Delay Number	Time Difference (ms)
0	0.0	14	1.4	28	2.8
1	0.1	15	1.5	29	2.9
2	0.2	16	1.6	30	3.0
3	0.3	17	1.7	31	3.1
4	0.4	18	1.8	32	3.2
5	0.5	19	1.9	33	3.3
6	0.6	20	2.0	34	3.4
7	0.7	21	2.1	35	3.5
8	0.8	22	2.2	36	3.6
9	0.9	23	2.3	37	3.7
10	1.0	24	2.4	38	3.8
11	1.1	25	2.5	39	3.9
12	1.2	26	2.6	40 - 98	4.0 - 9.8
13	1.3	27	2.7	99	9.9

---

## Adjusting and Storing the Time Correction (Storing available on CDA-9815 only)

---

Before performing the following procedures, refer to "About Time Correction" (page 17).

### 1 Press **T.CORR/X-OVER** to make time corrections.

Each press changes the mode as follows:

Bass Focus mode → Time Correction mode → normal mode  
→ Bass Focus mode

### 2 Press **BAND/TEL.** to select a speaker to be adjusted.

CDA-9815/CDA-9813

F-L → F-R → R-L → R-R → S-L → S-R → F-L

CDA-9811

F-L → F-R → R-L → R-R → F-L

### 3 Turn the **Rotary encoder** to adjust the desired time correction value.

*To store the adjusted contents (CDA-9815 only)*

1) Press and hold any one of the preset buttons (1 through 6) for at least 2 seconds into which you wish to store the adjusted contents.

### 4 Repeat step 2 and 3 to set another speaker.

### 5 After setting, press and hold **T.CORR/X-OVER** for at least 2 seconds to return to normal mode.

- If no operation is performed in 15 seconds, the unit returns to normal mode.

---

## Recalling the Stored Time Correction Settings (CDA-9815 only)

---

### 1 Press **T.CORR/X-OVER** to make time corrections.

Each press changes the mode as follows:

Bass Focus mode → Time Correction mode → Normal mode  
→ Bass Focus mode

### 2 Press the **preset button (1 through 6)** that has your desired time correction in memory.

### 3 Press and hold **T.CORR/X-OVER** for at least 2 seconds to return to normal mode.

- Time Correction mode is automatically canceled if no operation is performed within 15 seconds.

---

## Setting the MX Mode

---

MX (Media Xpander) makes vocals or instruments sound distinct regardless of the music source. The radio, CD, and MP3, will be able to reproduce the music clearly even in cars with a lot of road noise.

### 1 Press **MX** to select **MX ON**.

### 2 Press **SOURCE/POWER** to select the source to which you want to apply **MX (Media Xpander)**.

### 3 Press and hold **MX** for at least 2 seconds to activate the level setting mode.

### 4 Turn the **Rotary encoder** to select your preferred level or **OFF**.

#### **FM (MX level 1 to 3):**

The medium to high frequencies become clearer, and produces well balanced sound at all frequencies.

#### **CD (MX level 1 to 3):**

CD mode processes a large quantity of data. This data processing power takes advantage of CD quality sound sources.

#### **MP3/WMA/XM (MX level 1 to 3):**

This corrects information that was lost at the time of compression. This reproduces a well-balanced sound close to the original.

#### **DVD (Video CD)**

#### **(MOVIE MX level 1 to 2):**

The dialog portion of a video is reproduced more clearly.

#### **(MUSIC MX level 1):**

A DVD or Video CD contains a large quantity of data such as music clip. MX uses this data to reproduce the sound accurately.

#### **AUX (MX level 1):**

Choose the MX mode (MP3, MUSIC, or MOVIE) that corresponds to the media connected.

If two external devices are connected, a different MX mode for each media can be selected.

### 5 Press **Rotary encoder** to return to normal mode.

- To cancel MX mode for all music sources, press **MX** to turn **MX off**.
- **MX mode** is automatically canceled if no buttons are pressed within 15 seconds.
- Each music source, such as radio, CD, and MP3 can have its own **MX setting**.
- On disks with both **MP3/WMA** and **CD-DA**, when the source changes from "MP3/WMA to CD-DA" or "CD-DA to MP3/WMA," **MX-mode switching** may delay playback slightly.
- Setting to **MX OFF** sets **MX mode** of each music source to **OFF**.
- This function is inoperable when **DEFEAT** is set to **ON**.
- **MX mode** does not function when **MX** is set to **ON** for **AM radio**.
- If the unit is connected to an audio processor with the **MX function**, such as **PXA-H700**, etc., the **MX processing** can be applied to the audio processor. In this case the audio processor needs to be adjusted. For details, refer to the Owner's Manual of the audio processor.

# Other Functions

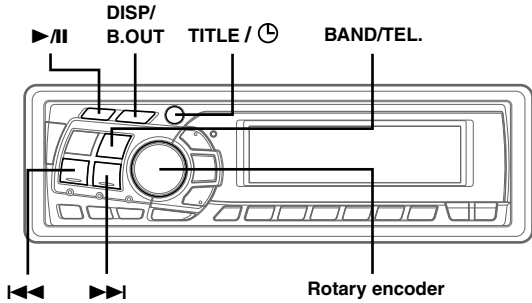

## Displaying the Title/Text

It is possible to display the CD/Station title if the title has been previously inputted ("Titrating Disc/Stations" page 21). Text information, such as the disc name and the track name, will be displayed if playing a CD text compatible disc. It is also possible to display the folder name, the file name, and the tag, etc., while playing MP3/WMA files.

### Press **TITLE** / ⌚.

The display will change every time the button is pressed.

#### The display in Radio mode:

CDA-9815

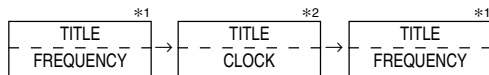

#### CDA-9813/CDA-9811

FREQUENCY → CLOCK → TITLE → FREQUENCY

#### The display in CD mode:

CDA-9815

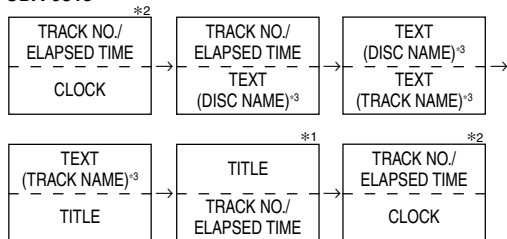

#### CDA-9813/CDA-9811

TRACK NO./ELAPSED TIME → TRACK NO./CLOCK → TEXT (DISC NAME)\*3 → TEXT (TRACK NAME)\*3 → TITLE → TRACK NO./ELAPSED TIME

#### The display in MP3/WMA mode:

CDA-9815

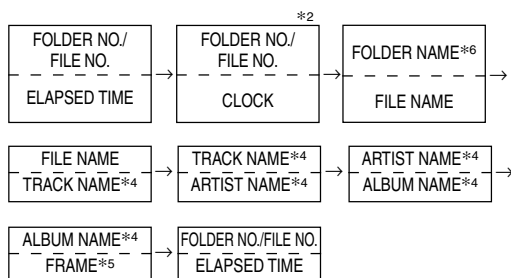

### CDA-9813/CDA-9811

FILE NO./ELAPSED TIME → FOLDER NO./FILE NO. → FILE NO./CLOCK → FOLDER NAME\*6 → FILE NAME → TRACK NAME\*4 → ARTIST NAME\*4 → ALBUM NAME\*4 → FRAME\*5 → FILE NO./ELAPSED TIME

\*1 TITLE can be input or erased.

\*2 CLOCK can be adjusted.

\*3 Displayed during playback of a disc with CD Text.

"NO TEXT" will be displayed when the CD contains no Text data.

\*4 ID3 tag/WMA tag

If an MP3/WMA file contains ID3 tag/WMA tag information, all the ID3 tag/WMA tag information is displayed (e.g., track name, artist name, and album name). All other tag data is ignored.

"NO DATA" will be displayed when an MP3/WMA file contains no ID3 tag/WMA tag information.

\*5 The recording sampling rate and bit rate of the MP3/WMA file are displayed.

\*6 "-----" is displayed for the folder name of the root folder (display example: CDA-9811).

## About "Title" and "Text"

### Title:

With this device, it is possible to input the CD/Station name (page 21). This inputted name is referred to as a "title." You cannot input or display titles on MP3/WMA discs.

### Text:

Text compatible CDs contain text information such as the disc name and track name. Such text information is referred to as "text."

- Some characters may not be displayed correctly with this device, depending on the character type.
- The CD changer must also be CD Text compatible for the Text information to be displayed.
- When the Scroll Setting (page 23) is set to "SCROLL MANUAL," press and hold **TITLE** / ⌚ for at least 3 seconds to scroll the Text information only once (TEXT DISPLAY, FOLDER NAME DISPLAY, FILE NAME DISPLAY or TAG DISPLAY mode).
- "NO SUPPORT" ("NO SUPRT" for CDA-9811) is displayed when the desired text information cannot be displayed on this unit.
- If the title was not previously input, "NO TITLE" is displayed.

---

## Titling Discs/Stations

---

It is possible to title your favorite CD's or radio stations.  
You cannot input titles on MP3/WMA discs.

**1 Press TITLE /  and select the Title Display.**  
For details, see "Displaying the Title/Text" (page 20). For CDA-9815, see asterisk 1 of "Displaying the Title/Text" (page 20).

**2 Press and hold TITLE /  for at least 3 seconds. The first character will blink.**  
*CDA-9815 only*  
**Press BAND/TEL. to select the characters/symbols.**

Upper case → Lower case → Numeral/Symbol  
→ Upper case



**3 Turn the Rotary encoder to select the desired letter/numeral/symbol available for naming.**

**4 Press Rotary encoder to store the first character.**  
The first character will stop blinking and the display will automatically advance to the next character. When that character begins to blink, you may choose the next letter or symbol of your title.

**5 Repeat steps 3 and 4 above to complete the titling.**  
Pressing the Rotary encoder after entering the 8th character automatically stores the title into memory.

When entering a title of less than 8 characters (for example, 3 character title):  
After entering 3 characters, the 4th character space will be blinking. Go to step 6 to complete the title.

**6 Press TITLE /  to record the title.**

- If you cancel while entering a title, selected characters are not written.
- You can enter 24 radio station titles and 18 CD titles on this unit. If you try to store beyond the limit, the display will show "FULL DATA." At this point, no more titles can be stored. To input a new title, one of the previously inputted titles must first be deleted.
- The CD Changer title length or memory capacity varies depending upon the model being used.
- When you want to erase a title, enter the "" ("" for CDA-9815) symbol into all spaces.
- The operations described in steps 3 to 5 must be made within 10 seconds. The input mode will be canceled if no action is taken for over 10 seconds.

---

## Erasing Disc Title/Station Title

---

**1 Press TITLE /  to select the Title Display. Then, press again and hold for at least 3 seconds.**

- For CDA-9815, see asterisk 1 of "Displaying the Title/Text" (page 20).

**2 Press and hold /II for at least 2 seconds.**  
The title in the display will blink.

**3 Press  or  repeatedly until the title you want to erase is displayed.**

**4 Press and hold /II for at least 2 seconds to erase the title displayed.**

**5 Press TITLE /  to cancel the title erasing mode.**

- You cannot erase CD-TEXT.
- "NO DATA" is displayed for 2 seconds if the title is not input in step 2, or if the title is erased in step 4.

---

## Displaying Time

---

**Press TITLE /  repeatedly until the time is displayed.**

Each press changes the display.  
For details, see "Displaying the Title/Text" (page 20).

- Selecting any tuner or CD function while in the clock priority mode will interrupt the time display momentarily. The function selected will be displayed for about 5 seconds before the time returns to the display.
- When the power is off but the ignition key is on, press TITLE /  to display the time.

---

## Blackout Mode On and Off

---

When Blackout mode is turned on, the display will turn off to reduce power consumption.

This additional power enhances the sound quality.

**Press and hold DISP/B.OUT for at least 3 seconds to activate the blackout mode.**

The display will turn off.

- If any button on the unit is pressed during the blackout mode, the function will be displayed for 5 seconds to show the operation before returning to Blackout mode.

To cancel Blackout mode, press and hold **DISP/B.OUT** for at least 3 seconds.

# i-Personalize™

## Operation (CDA-9815 only)

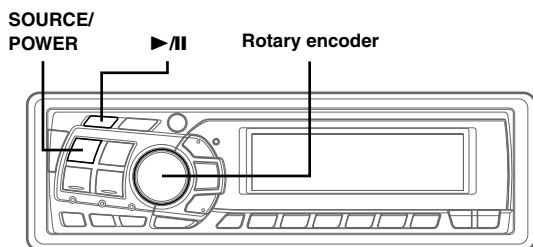

### About i-Personalize™

You can download data (from Alpine's website) to a CD-R, and download and store the data to the CDA-9815. To start i-Personalize, access the URL below and follow the on-screen instructions.

<http://www.alpine.com> or <http://www.alpine-usa.com>

Downloadable data

Parametric equalizer	Data is memorized in Preset 6 of the Parametric EQ Mode.
Time correction	Data is memorized in Preset 6 of the Time Correction Mode.
Crossover	Data is memorized in Preset 6 of the crossover mode.

The file name of download data shall be "A\_U\*\*\*\*\*.MP3."

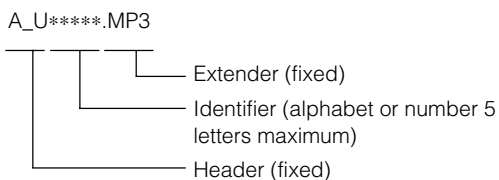

You can create a file name via the website. Do not change a file name once it has been created. Malfunction may result.

- For details about procedures of download, see ALPINE's Web site.
- If a external audio processor is connected, data that is downloaded cannot be used.

### Data Downloading

- 1 Insert the CD-R disc containing the data. If the source is not the CD mode, press SOURCE/POWER to change to CD mode.**
- 2 Press and hold ▶/II for at least 2 seconds.**  
The mode switches to the download mode to show the download confirmation screen.
- 3 Turn the Rotary encoder to select "OK," then press the Rotary encoder.**  
Data search of the disc starts and the first file name is displayed.
  - Selecting "NG" will halt the download mode.
  - If a file is not found by the data search, "NO FILE" is indicated.
  - The "NO FILE" display will automatically disappear if no operation is performed for 5 seconds.
- 4 Turn the Rotary encoder to select "DOWNLOAD," and then press the Rotary encoder to start.**

Data downloading starts.

The file currently shown in the display is downloaded. If you want to download other files, select NEXT FILE to call up file names.

CANCEL : Halts the download  
 DOWNLOAD : Starts the download  
 NEXT FILE : Searches the next file

- 5 When data download is finished successfully, the confirmation screen is displayed for 5 seconds and the download mode closes.**

Successfully downloaded items are indicated as checked boxes on the confirmation screen.

#### PARAMETRIC EQ data

The data is memorized in Preset 6 of Parametric EQ mode. The memorized data settings in Preset 6 (Parametric EQ mode) are automatically applied.

#### X-OVER (Cross over) data

The data is memorized in Preset 6 of X-OVER mode. The memorized data settings in Preset 6 (X-OVER mode) are automatically applied. You cannot download the data if the setting of the 2WAY/3WAY switch is not suitable for the data.

#### TIME CORRECTION data

The data is memorized in Preset 6 of the Time correction mode. The memorized data settings in Preset 6 (Time Correction mode) are automatically applied.

- When you download the data again, the data is overwritten in Preset 6.



# SETUP

You can flexibly customize the unit to suit your own preferences and usage. Choose the SETUP menu from Sound Customizing, Visual Customizing, etc., to select your desired setting.

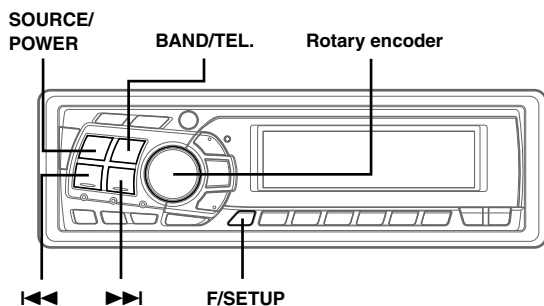

The common operation for SETUP is step 1 to 4 as follows. See down below for further information about each SETUP menu.

- 1 Press and hold F/SETUP for at least 3 seconds.**  
SETUP mode is activated.
- 2 Press ◀◀ or ▶▶ to select the desired SETUP menu.**  
(e.g. Select BEEP)

Here is the explanation for CDA-9815 display example.

NORMAL/Hi-Fi/STABLE → DIMMER\*<sup>2</sup> → SUB-W →  
SUB-W STEREO/SUB-W MONO\*<sup>2</sup> → CD-DA / CD-DA/MP3 →  
BEEP → SCROLL → SCROLL TYPE\*<sup>1</sup> → MUTE → INTERRUPT  
→ AUX → (AUX name)\*<sup>3</sup> → PWR-IC → CONTRAST\*<sup>1</sup> →  
FONT\*<sup>1</sup> → AREA \*<sup>4</sup> → DEMO → NORMAL/Hi-Fi/STABLE

\*<sup>1</sup> CDA-9815 only.

\*<sup>2</sup> CDA-9815/CDA-9813 only.

\*<sup>3</sup> Displayed only when AUX is ON.

\*<sup>4</sup> "Radio" (page 8)

- 3 Press BAND/TEL. to change the setting.**  
(e.g. Select BEEP ON or BEEP OFF.)
- 4 Press F/SETUP again.**  
The display returns to normal mode.

## Sound Customizing

### Switching the Tuner Mode

**NORMAL (Initial setting) / HI-FI / STABLE**

This unit incorporates the MAX TUNE SQ for the highest quality tuner audio. Moreover, you can choose between three settings to suit your own personal sound preferences and usage.

NORMAL: Standard setting

HI-FI: Sound quality priority setting

STABLE: Noiseless priority setting

- If you find the sound is very noisy while listening to the tuner in Hi-Fi mode, we recommend you change to Normal mode.

### Subwoofer On and Off

**SUB-W ON (Initial setting) / SUB-W OFF**

When the subwoofer is on, perform the steps below to adjust the subwoofer output phase and level.

- Press the **Rotary encoder** repeatedly to select the SUB-W mode.

SUB-W → BALANCE → FADER → DEFEAT → VOLUME → SUB-W

- Press **◀◀** or **▶▶**.

The subwoofer output phase is toggled SUB-W NORMAL (0°) or SUB-W REVERS (180°).  
To adjust the level, turn the Rotary encoder.

### Setting the Subwoofer Output (CDA-9815/CDA-9813 only)

**STEREO (Initial setting) / MONO**

You can set the subwoofer output to stereo or monoaural. Make sure to set the correct output for your subwoofer type.

STEREO: Subwoofer stereo (L/R) output

MONO: Subwoofer monoaural output

### Sound (Beep) Guide Function

**BEEP ON (Initial setting) / BEEP OFF**

This function will give audible feedback with varying tones depending upon the button pressed.

## Visual Customizing

### Dimmer Control (CDA-9815/CDA-9813 only)

**DIMMER AUTO (Initial setting) / DIMMER MANUAL**

Set the DIMMER control to AUTO to decrease the illumination brightness of the unit with the head lights of the vehicle ON. This mode is useful if you feel the unit's backlighting is too bright at night.

### Scroll Setting

**SCROLL AUTO / SCROLL MANUAL (Initial setting)**

This CD player can scroll the disc and track names recorded on CD-TEXT discs, as well as the text information of MP3/WMA files, folder names, and tags.

SCROLL AUTO : The CD text information, the text information of folder and file names, and the tags are scrolled automatically.

SCROLL MANUAL : The display is scrolled only when a disc is loaded or when a track is changed, etc.

- The unit scrolls CD text names, folder names, file names or tag display. The disc titles input manually (page 21) cannot be scrolled.

## Scroll Type Setting (CDA-9815 only)

### TYPE1 (Initial setting)/TYPE2

Two types of scroll can be selected.

- TYPE1: The upper line and lower line scroll alternately.
- TYPE2: The upper line and lower line scroll at the same time, but at different speeds, when the "Scroll Setting" (page 23) is set to "SCROLL AUTO."

## Switching the Character Font (CDA-9815 only)

### TYPE-1 (Initial setting)/TYPE-2

Two types of font can be selected.

You can select the font type you like.

## Adjusting Display Contrast (CDA-9815 only)

### CONTRAST

You can adjust the display contrast for better visibility.

You can adjust in a range of - 6 and + 6.

- The initial setting at the factory is "0."

## Demonstration

### DEMO ON/DEMO OFF (Initial setting)

This unit has a Demonstration feature which simulates the display functions.

- To quit Demo mode, set to DEMO OFF.

## MP3

### Playing MP3 Data

#### CD-DA (Initial setting)/CD-DA/MP3

This product can playback CDs containing both CD and MP3 data. However, in some situations (some enhanced CDs), playback may be difficult. For these special cases, you can select playback of CD data only. When a disc contains both CD or the MP3 data, playback starts from the CD data portion of the disc.

- CD-DA : Only CD data can be played back.
- CD-DA/MP3 : Both CD data and MP3/WMA file tracks can be played back.

- Perform this setting before inserting a disc. If a disc has already been inserted, perform the setting after you remove the disc. (If you use an MP3 changer, you have to change discs.)

## External Device

### Turning Mute Mode On/Off

#### MUTE ON (Initial setting)/ MUTE OFF

If a device having the interrupt feature is connected, audio will be automatically muted whenever the interrupt signal is received from the device.

### Setting the AUX Mode (V-Link)

#### AUX ON / AUX OFF (Initial setting)

You can input TV/video sound by connecting an optional Ai-NET/ RCA Interface cable (KCA-121B) or Versatile Link Terminal (KCA-410C) to this component.

You can change the AUX name display when AUX ON is set. Select the AUX name by pressing **◀◀** or **▶▶**. Then press **BAND/TEL**.

If the KCA-410C is connected, it is possible to select two AUX names.

- Via KCA-410C, up to 2 external devices with RCA output can be connected. In this case, press **SOURCE/POWER** to select AUX mode and then press **BAND/TEL**, to select your desired device.

## Connecting to an External Amplifier

### PWR-IC ON (Initial setting) / PWR-IC OFF

When an external amplifier is connected, sound quality can be improved by stopping the power supply of the built-in amplifier.

**PWR-IC OFF** : Use this mode when the front and rear pre-amplifier of the unit are used to drive an external amplifier connected to the speakers. In this setting, the head unit's internal amplifier has no output to drive speakers.

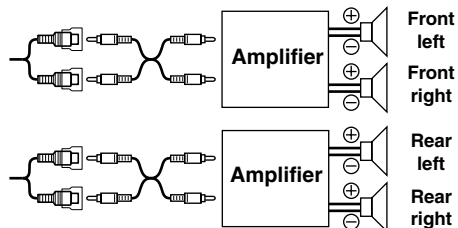

(Connecting example for CDA-9815)

**PWR-IC ON** : The speakers are driven by the built-in amplifier.

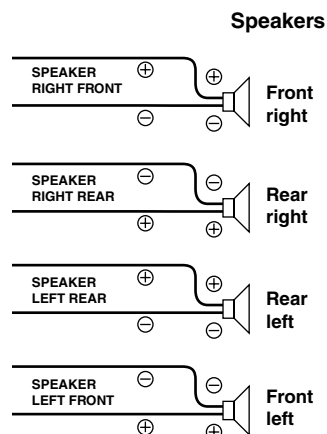

- No sound is produced by the system when the power output is set to OFF.

## Setting Tone Defeat for External Devices

### INTERRUPT ON / INTERRUPT OFF (Initial setting)

When inputting external devices to this unit, turning tone defeat on will bypass BASS, TREBLE, EQ and MX, i.e., sound for external devices is output at the default setting.

# XM Radio (Optional)

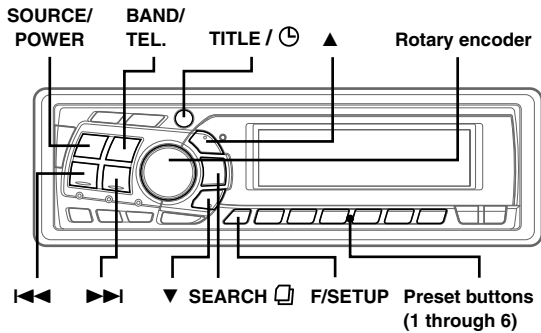

## Receiving XM Channels with the XM Receiver (Optional)

XM Satellite Radio\* is the next generation of audio entertainment, with up to 100 brand-new digital channels. For a small monthly fee, subscribers can hear crystal-clear music, sports, news and talk, coast-to-coast via satellite. For more information, visit XM's website at [www.xmradio.com](http://www.xmradio.com) or call 1-800-852-9696.

An optional XM Satellite Radio Receiver (TUA-T021XM) and an optional XM antenna may be connected to the CDA-9815/CDA-9813/CDA-9811. With an XM Receiver connected to the Ai-NET input of the CDA-9815/CDA-9813/CDA-9811, the XM Receiver will be controllable from the CDA-9815/CDA-9813/CDA-9811.

\* XM and its corresponding logos are trademarks of XM Satellite Radio Inc.

- The controls on the CDA-9815/CDA-9813/CDA-9811 for XM Receiver operation are operative only when an XM Receiver is connected.
- The XM1, XM2 or XM3 band illuminates when in XM mode.

**1 Press SOURCE/POWER to select XM mode.**

**2 Press BAND/TEL. to select XM1, XM2 or XM3.**

Each press changes the band:

XM1 → XM2 → XM3 → XM1

**3 Press ◀◀ or ▶▶ to select the desired channel.**

Holding the ◀◀ or ▶▶ will change channels continuously.

## Checking the XM Radio ID Number

You need to provide XM with the unique XM Radio ID number for your XM Radio Receiver in order to subscribe to XM's programming.

This number is an 8 character alphanumeric number that is printed on a label directly on the XM Receiver.

It can also be displayed on the screen of the CDA-9815/CDA-9813/CDA-9811 in the following way.

**1 While receiving XM1, XM2 or XM3, press ◀◀ or ▶▶ to select channel "0."**

The unit alternately displays "RADIO ID" for 2 seconds, then the ID number for 10 seconds.

While displaying "RADIO ID" as shown above, Blackout (page 21) and Demonstration (page 24) become nonfunctional.

**2 To cancel the ID number display, set the channel to other than "0."**

- There is another way to display your ID number.

1. Press and hold F/SETUP for at least 3 seconds.

2. Press ◀◀ or ▶▶ repeatedly to select "ID."

3. Press BAND/TEL. to display your ID number.

4. After checking your ID number, press F/SETUP to return to the normal display.

- You cannot use "O," "S," "I," or "F" for the ID Number.
- You can check your ID number printed on the label on the package of your XM Satellite Radio Receiver (TUA-T021XM).

## Storing XM Channel Presets

**1 Press BAND/TEL. to select the desired band (XM1, XM2 or XM3) you want to store.**

**2 After tuning in the desired channel, press and hold any one of the preset buttons (1 through 6) that you want to store the station on for at least 2 seconds.**

The selected station is stored.

**3 Repeat the procedure to store up to 5 other channels onto the same band.**

- To use this procedure for other bands, simply select the band desired and repeat the procedure.
- A total of 18 channels can be stored in the preset memory (6 channels for each band; XM1, XM2 and XM3).
- If you store a channel in a preset memory which already has a station, the current channel will be cleared and replaced with the new one.

## Receiving Stored XM Channels

**1 Press BAND/TEL. to select the desired band (XM1, XM2 or XM3).**

XM1 → XM2 → XM3 → XM1

**2 Press the channel preset button that has your desired satellite channel in memory.**

## Channel/Category Search Function

You can search for programs by Channel No. or Category.



- 1 Press **SEARCH**  in the XM mode to select Channel Search mode or Category Search mode.

### Channel Search mode:

- 2 Turn the **Rotary encoder** to select the desired Channel No.\* within 10 seconds.

\* The Channel No. is selected within the selected Category.



- 3 Press **Rotary encoder** to receive the selected Channel No.

- Search mode is canceled by pressing and holding **SEARCH**  for at least 2 seconds in Channel Search mode.
- While in Channel Search mode, press **SEARCH**  to switch to the Category display. Press **▲** or **▼** to select the another Category.

### Category Search mode:

- 2 Turn the **Rotary encoder** to select the desired Category within 10 seconds.

- 3 Press **Rotary encoder** to receive the selected Category.

- Search mode is canceled by pressing and holding **SEARCH**  for at least 2 seconds in Category Search mode.
- While in Category Search mode, press **SEARCH**  to switch to Channel Search mode.

## Quick Search Function

You can search for all Channels.

- 1 Press and hold **SEARCH**  for at least 2 seconds in XM mode to activate Quick Search mode.

- 2 Turn the **Rotary encoder** to select the desired Channel within 10 seconds.

The selected Channel is received.

## Changing the Display

Text information, such as the channel name, artist name/feature, and song/program title, is available with each XM channel. The unit can display this text information as explained below.

In XM mode, press **TITLE** / .

Each time you press this button, the display changes as shown below.

CDA-9815

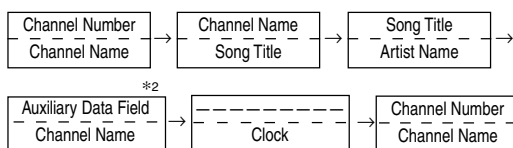

CDA-9813/CDA-9811

Channel Number\*1 → Channel Name → Song Title → Artist Name → Auxiliary Data Field\*2 → Clock → Channel Number\*1

\*1 The Channel Name display automatically changes after 5 seconds.

\*2 When ADF is turned OFF, this information is not displayed (see "Setting the Auxiliary Data Field Display" on this page).

- When the "Scroll Setting" (page 23) is set to "SCROLL AUTO," the display scrolls continuously. When the Scroll Setting is set to "SCROLL MANUAL," the display scrolls only once after any function is performed (PRESET, BAND, SEARCH, etc.). Press and hold **TITLE** /  for more than 3 seconds to scroll the display manually.
- "Channel Number" and "Clock" displays do not scroll.
- Depending on the model, the display may differ from the one shown above.

## Setting the tuning method

You can set the tuning method. You can select the received stations in channel no. order or in channel name order (alphabetic order).

- 1 Press and hold **F/SETUP** for at least 3 seconds.

- 2 Press **◀◀** or **▶▶** to select "CH NO" or "ALPHABET."

- 3 Press **BAND/TEL.** to set the tuning method.

CH NO : Set in order of channel no.

ALPHABET : Set in alphabetic order.

- 4 Press **F/SETUP** to return to normal mode.

- When the setting is completed, switch the channel DOWN/UP by pressing the **◀◀** or **▶▶**.

## Setting the Auxiliary Data Field Display

The XM Auxiliary Data Field display can be switched on or off.

- 1 Press and hold **F/SETUP** for at least 3 seconds.

- 2 Select "ADF" (Auxiliary Data Field) by pressing **◀◀** or **▶▶**.

- 3 Select ON/OFF by pressing **BAND/TEL.**

When setting to ON, Auxiliary Data Field is displayed by pressing **TITLE** / . (Refer to the "Changing the Display" section on this page.)

- 4 Press **F/SETUP** to return to normal mode.

# MobileHub™ Link Operation(Optional)

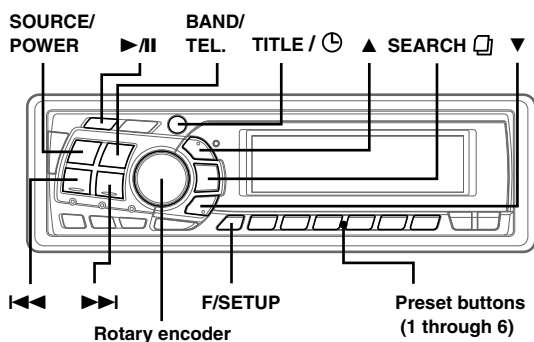

## About MobileHub™ Link

Connect a separately sold junction box and a portable telephone (available from Nokia) to control the incoming and outgoing calls of the portable telephone.

### Caution

Even with hands-free operation, a driver can be distracted during telephone operation or receiving a call. For the sake of safety, drivers are requested to refrain from operating the telephone while driving.

For the sake of safety, only incoming calls and Speed-Dial outgoing calls can be operated.

- If a portable telephone is connected, its address book, incoming and outgoing history are downloaded to the junction box.
- Please refer to the instruction manual of the junction box.

## Telephone Mode ON/OFF

### 1 Press and hold **BAND/TEL.** for at least 2 seconds to turn on the Telephone mode.

To turn off, press **BAND/TEL.**  
See relevant pages for each item.

- When a portable telephone is not connected, press and hold **BAND/TEL.** for at least 2 seconds. "NO PHONE" is displayed for about 2 seconds, then the mode returns to the original source mode
- When the portable telephone is taken off the junction box during an incoming or outgoing call, or during a hands-free call, the call will be treated as an ordinary one by the portable telephone.
- When there is an incoming call while the power of CDA-9815/CDA-9813/CDA-9811 is off, the power of CDA-9815/CDA-9813/CDA-9811 will turn on automatically for a hands-free call.
- Even if the power of the portable telephone is off, when CDA-9815/CDA-9813/CDA-9811 is set to Telephone mode, the power of the portable telephone will be turned on.
- Even if the ACC power of the vehicle is turned off (even if the engine is stopped) during a hands-free call, the call is not disconnected, and an ordinary call by the portable telephone is possible.
- If there is an incoming call during operation (except an outgoing call or talking), operation mode will end and switch to the incoming or talking mode.
- An outgoing call from a portable telephone is also possible.

However, you cannot perform different operations at the same time from a portable telephone and CDA-9815/CDA-9813/CDA-9811 as malfunction can result.

- With a junction box connected outgoing, incoming, and sending history will also be recorded in the portable telephone.
- While telephoning, defeat is set to ON. When the call has finished, the unit returns to your previous setting.
- The telephone volume can be adjusted on the CDA-9815/CDA-9813/CDA-9811. The volume you set during the call is memorized, and is automatically applied again on the next call.
- While telephoning or receiving incoming calls, press **TITLE /** to show the Network Operator display for 5 seconds.

## Incoming Calls

### 1 Press **▶/||** to receive an incoming call.

### 2 Press **BAND/TEL.** to finish a call.

Telephone mode will end and return to the original source mode.

- When the Automatic Calling mode is on, you can talk after 3 seconds of receiving the incoming call.
- The incoming call can be switched to Automatic Calling or Manual Calling.

1 Press and hold **F/SETUP** for at least 3 seconds.

2 Select the Telephone mode by pressing **◀** or **▶**.

3 Press **BAND/TEL.** to change to AUTO or MANUAL (MANU).

4 Press **F/SETUP** to return to normal mode.

- Press **BAND/TEL.** during an incoming call to disconnect it.

## Calling

### Calling by the address book

You can call up the address book registered in the portable telephone to call from.

- 1 Press and hold **BAND/TEL.** for at least 2 seconds.
- 2 Press **SEARCH**  to select Phone Book mode.  
A list in alphabetic order is displayed.

### Retrieving an addressee by Alphabetic Sort List

- 3 When displaying the Alphabetic Sort List, turn the **Rotary encoder** or press **◀◀** or **▶▶** to select the addressee.
- 4 Press **▶/II** or **Rotary encoder** to place a call.
- 5 Press **BAND/TEL.** to end the call.  
Telephone mode will end and return to the original source mode.

### Retrieving an addressee by Selecting Search (A-Z search)

- 3 Press **▲** or **▼** to select an initial letter (A to Z) of the addressee.
- 4 Turn the **Rotary encoder** to select the addressee.
- 5 Press the **Rotary encoder** to place a call.
- 6 Press **BAND/TEL.** to end the call.  
Telephone mode will end and return to the original source mode.

- If all telephone numbers and registered names cannot be displayed at once, press **TITLE** /  to show undisplayed numbers and names.
- “NO MEMORY” (“NO MEM” for CDA-9811) is displayed if nothing is registered in the Phone Book.



### Calling by using the Speed Dial

You can place a call by retrieving one of the telephone numbers registered in No. 1 to 9 of the address book.

- 1 Press and hold **BAND/TEL.** for at least 2 seconds.
- 2 Within 5 seconds, press and hold (for at least 2 seconds) a **preset button (1 through 6)** to place a call.  
By pressing **F/SETUP**, and then pressing a **preset button (1 through 3)** for at least 2 seconds, you can place a call to the number registered in 7 to 9.
  - You can place a call by pressing **▶/II** after momentarily pressing the **preset button (1 through 6)** of the number you wish to call.
  - You can place a call by pressing the **Rotary encoder**, after selecting a number which you wish to call, by pressing **◀◀** or **▶▶**, or by turning the **Rotary encoder**.
- 3 Press **BAND/TEL.** to end the call.  
Telephone mode will end and return to the original source mode.
  - If there is no telephone number registered to a preset button, “NO PRESET” (“NO P-SET” for the CDA-9811) is displayed when you try to place a call.

### Calling by the outgoing/incoming/absent incoming history

You can place a call to any of the last 999 calls by the outgoing/incoming/absent incoming history.

- 1 Press **SEARCH**  in Phone Book mode to select the History mode.
- 2 Press **▲** or **▼** to select outgoing history (display example: “DIALED”), incoming history (display example: “RECEIVED”), absent incoming history (display example: “MISSED”).
- 3 Turn the **Rotary encoder**, or press **◀◀** or **▶▶** to select the addressee from the outgoing or incoming history.
- 4 Press **▶/II** or the **Rotary encoder** to place a call.
- 5 Press **BAND/TEL.** to end the call.  
Telephone mode will end and return to the original source mode.
  - If all telephone numbers and registered names cannot be displayed at once, press **TITLE** /  to show undisplayed numbers and names.
  - “NO MEMORY” (“NO MEM” for CDA-9811) is displayed if there is no incoming history.

## SMS (Short Message Service) Operation

You can be informed when you receive a short message.

### Receiving a short message

- 1 When a text message is received, “NEW MESSAGE” for CDA-9815, “NEW MESSAG” for CDA-9813 or “NEW MSG” for CDA-9811 is indicated on the display.  
The contents of the received message can only be read from the portable phone’s display.
- 2 Press any one of the buttons on the unit to cancel the display. The buttons that are pressed will enter the mode or will be activated.

# Changer (Optional)

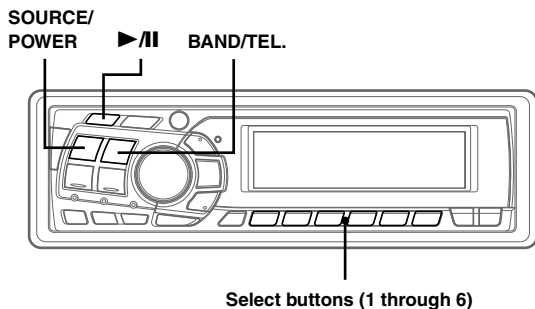

## Controlling CD Changer (Optional)

An optional 6-disc or 12-disc CD Changer may be connected to this unit if it is Ai-NET compatible. With a CD Changer connected to the Ai-NET input of this unit, the CD Changer will be controllable from this unit.

Using the KCA-400C (Multi-Changer Switching device) or the KCA-410C (Versatile Link Terminal) multiple changers can be controlled by this unit.

See "Multi-Changer Selection" on this page for selecting the CD Changers.

- The controls on this unit for CD Changer operation are operative only when a CD Changer is connected.
- The DVD changer (optional) is controllable from this unit as well as the CD changer.

### 1 Press **SOURCE/POWER** to activate the CHANGER mode.

The display shows the disc number and track number.

- The source indicator varies depending on the connected source.
- Press **BAND/TEL.** to switch the Disc mode in the CD/Changer mode.

### 2 Press the disc select buttons (1 through 6) corresponding to one of the discs loaded in the CD Changer.

The selected disc number appears in the display and CD playback starts.

- After selecting the desired disc, you can operate in the same way as for the CD player of this unit.  
For details, please see the CD/MP3/WMA section.
- If the "FUNC" indicator (the underlined portion of the "FUNC" indicator for CDA-9811) is illuminated, the disc select buttons become nonfunctional.

#### When a 12-disc CD Changer is connected:

To select discs numbered from 1 to 6, the procedure is the same as for the 6-disc CD Changer. To select discs numbered from 7 to 12, first press F/SETUP. This changes the "D" indicator to "d." Then press the desired preset button. With F/SETUP activated, the preset buttons 1 to 6 will represent discs 7 to 12 respectively.

## Playing MP3 Files with the CD Changer (Optional)

If you connect a changer compatible with MP3, you can play CD-ROMs, CD-Rs, and CD-RWs containing MP3 files on this unit.

### 1 Press **SOURCE/POWER** to switch to the MP3 Changer mode.

### 2 Press any one of the disc select buttons (1 through 6) corresponding to one of the discs loaded in the CD Changer.

### 3 To pause playback, press **▶/II**. Pressing **▶/II** again will resume playback.

- The unit can play discs containing both audio data and MP3 data.

## Multi-Changer Selection (Optional)

Alpine's Ai-NET system will support up to 6 CD Changers. When operating two or more changers, the KCA-400C (Multi-Changer Switching device) must be used. If you use 1 Switching device, you can connect up to 4 CD Changers. If you use 2 Switching devices, you can connect up to 6 CD Changers. When using KCA-410C (Versatile Link Terminal), you can connect two changers and two external outputs (AUX).

### 1 Press **SOURCE/POWER** on this unit to activate the CD Changer mode.

Alternatively, press SOURCE on the remote control (RUE-4187) to activate the CD Changer mode.

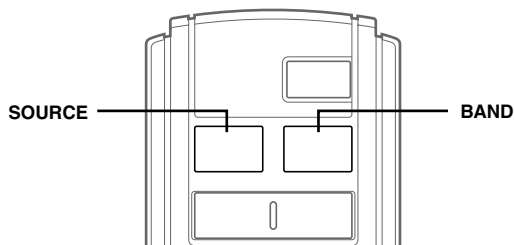

### 2 Press **BAND/TEL.** on this unit or the RUE-4187 to activate the CD Changer Selection mode.

The CD Changer Selection mode remains active for 8 seconds.

### 3 Press **BAND/TEL.** until the desired CD Changer indicator appears on the display.

Alternatively press BAND/TEL. on the Remote Control until the desired changer indicator appears on the display.

- If the selected CD Changer is not connected, the display will show "NO CHGR" ("NO CHANGER" for CDA-9815).
- To operate the selected changer, see "CD/MP3/WMA" (page 9).
- For further details about the external input (AUX) when using KCA-410C, see "Setting the AUX Mode (V-Link)" on page 24.

# Remote Control

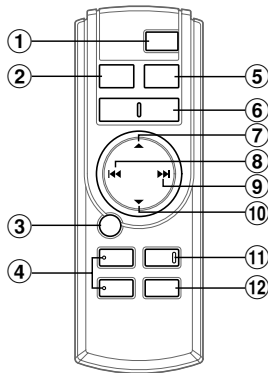

## Controls on Remote Control

- ① **Power Button**  
Press this button to turn the power on/off.
- ② **Source Button**  
Press this button to select the audio source.
- ③ **▶/|| Button**  
Press this button to switch between the Play and Pause modes for CD.
- ④ **TILT ▼▲ Buttons**  
Press this button to adjust the angle of the movable display.
- ⑤ **Band/Program Button**  
Radio mode: BAND Button  
Press this button and the band will change.  
CD/Changer mode: To switch the disc mode.
- ⑥ **Volume Adjustment Buttons**  
To increase the volume level:  
Press the [▲] button  
  
To decrease the volume level:  
Press the [▼] button
- ⑦ **▲ Button**  
Radio mode: Pressing this button will select, in ascending order, stations programmed into the radio's presets as shown below.  
[1] → [2] ... [6] → [1]  
CD Changer mode: DISC Select (UP) button  
Press this button to select a disc in ascending order.  
MP3/WMA mode: Press the Folder Select (UP) button to select the folder.
- ⑧ **◀◀ DN Button**  
Radio mode: SEEK (DN) Button  
CD mode: Press this button to go back to the beginning of the current track.

- ⑨ **▶▶ UP Button**  
Radio mode: SEEK (UP) button  
CD mode: Press this button to advance to the beginning of the next track.
  - ⑩ **▼ Button**  
Radio mode: Pressing this button will select, in descending order, stations programmed into the radio's presets as shown below.  
[6] → [5] ... [1] → [6]  
CD Changer mode: DISC Select (DN) button  
Press this button to select a disc in descending order.  
MP3/WMA mode: Press the Folder Select (DN) button to select the folder.
  - ⑪ **Mute Button**  
Press this button to lower the volume by 20 dB instantly. Press this button again to cancel.
  - ⑫ **Audio Processor Button\*<sup>1</sup>**  
CDA-9815/CDA-9813 only  
Each press the button to switch the audio processor mode.  
For details, refer to "Operating the Audio Processor" as shown below.  
CDA-9815/CDA-9813/CDA-9811  
Press the button to call the external audio processor mode when the external audio processor is connected.\*<sup>2</sup>
- \*<sup>1</sup> This button is used for CDA-9811 in conjunction with an optional Ai-NET processor.*
- \*<sup>2</sup> For the operation of external audio processor, refer to the Owner's Manual of the external audio processor you purchased.*

## Operating the Audio Processor

### 1 Press A.PROC to select the mode.

Normal mode → EQ mode (Equalizer Presets) → Private mode (Recalling the Stored Equalizer Curve) → Time Correction mode (Recalling the Stored Time Correction) → Crossover mode (Recalling the Stored Crossover) → Normal mode

### 2 Press ▲ or ▼ to select the mode.

EQ mode  
Select from FLAT, POPS, ROCK and NEWS.  
Private mode/Time Correction mode/Crossover mode  
Select from MEMORY 1 through 6.



## Battery Replacement

Applicable battery: Use two "AAA" sized dry batteries or equivalent.

### 1 Opening the battery cover

Slide out the battery cover while firmly pressing in the direction of the arrow.

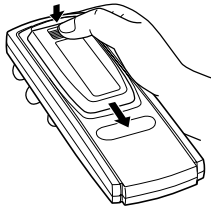

### 2 Replacing the battery

Insert the batteries, observing the polarities as illustrated.

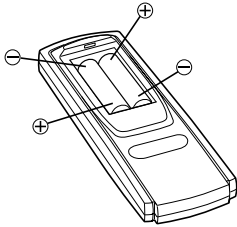

### 3 Closing the cover

Slide the cover as illustrated until a click is heard.

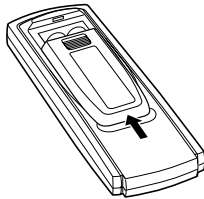

Point the remote control transmitter at the remote control sensor.

Remote control sensor

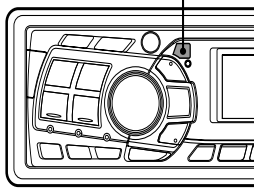

## Information

### In Case of Difficulty

If you encounter a problem, please turn the power off, then on again. If the unit is still not functioning normally, please review the items in the following checklist. This guide will help you isolate the problem if the unit is at fault. Otherwise, make sure the rest of your system is properly connected or consult your authorized Alpine dealer.

#### Basic

##### No function or display.

- Vehicle's ignition is off.
  - If connected following instructions, the unit will not operate with the vehicle's ignition off.
- Improper power lead connections.
  - Check power lead connections.
- Blown fuse.
  - Check the fuse on the battery lead of the unit; replace with the proper value if necessary.
- Internal micro-computer malfunctioned due to interference noise etc.
  - Press the RESET switch with a ballpoint pen or other pointed article.

#### Radio

##### Unable to receive stations.

- No antenna or open connection in cable.
  - Make sure the antenna is properly connected; replace the antenna or cable if necessary.

##### Unable to tune stations in the seek mode.

- You are in a weak signal area.
  - Make sure the tuner is in the DX mode.
- If the area you are in is a primary signal area, the antenna may not be grounded and connected properly.
  - Check your antenna connections; make sure the antenna is properly grounded at its mounting location.
- The antenna may not be the proper length.
  - Make sure the antenna is fully extended; if broken, replace the antenna with a new one.

##### Broadcast is noisy.

- The antenna is not the proper length.
  - Extend the antenna fully; replace it if it is broken.
- The antenna is poorly grounded.
  - Make sure the antenna is grounded properly at its mounting location.

#### CD

##### CD Player/Changer not functioning.

- Out of operating temperature range +50°C (+120°F) for CD.
  - Allow the vehicle's interior (or trunk) temperature to cool.

##### CD playback sound is wavering.

- Moisture condensation in the CD Module.
  - Allow enough time for the condensation to evaporate (about 1 hour).

### CD insertion not possible.

- A CD is already in the CD player.
  - Eject the CD and remove it.
- The CD is being improperly inserted.
  - Make sure the CD is being inserted following instructions in the CD Player Operation section.

### Unable to fast forward or backward the CD.

- The CD has been damaged.
  - Eject the CD and discard it; using a damaged CD in your unit can cause damage to the mechanism.

### CD playback sound skips due to vibration.

- Improper mounting of the unit.
  - Securely re-mount the unit.
- The disc is very dirty.
  - Clean the disc.
- The disc has scratches.
  - Change the disc.
- The pick-up lens is dirty.
  - Do not use a commercial available lens cleaner disc. Consult your nearest ALPINE dealer.

### CD playback sound skips without vibration.

- The disc is dirty or scratched.
  - Clean the disc; damaged disc should be replaced.

### Error displays (built-in CD player only)

- Mechanical error
  - Press **▲**. After the error indication disappears, insert the disc again. If the above-mentioned solution does not solve the problem, consult your nearest ALPINE dealer.

### CD-R/CD-RW playback not possible

- Close session (finalization) has not been performed.
  - Perform finalization and attempt playback again.

## MP3/WMA

### MP3 or WMA is not played back.

- Writing error occurred. The CD format is not compatible.
  - Make sure the CD has been written in a supported format. Refer to "About MP3/WMA" (page 11-12), then rewrite in the format supported by this device.

## Indication for CD Player

### HIGH TEMP

(CDA-9815)

### HI TEMP

(CDA-9813/CDA-9811)

- Protective circuit is activated due to high temperature.
  - The indicator will disappear when the temperature returns to within operation range.

### NO DISC

- No CD is inserted.
  - Insert a CD.
- Although a disc is inserted, "NO DISC" is displayed and the unit does not start to play or eject the disc.
  - Remove the disc by following these steps:
    - 1) Press the **▲** button.  
The movable display will open.
    - 2) Press the **▲** button again for at least 3 seconds while the movable display is open.

### ERROR

- Mechanism error.
  - 1) Press the **▲** button and eject the CD.  
If not ejecting, consult your Alpine dealer.
  - 2) When the error indication remains after ejecting, press the **▲** button again.  
If the error indication still does not turn off after pressing the **▲** button for a few times, consult your Alpine dealer.
- When "ERROR" is displayed:  
*If that the disc cannot be ejected by pressing **▲**, press the RESET switch (refer to page 6) and press **▲** again.  
If the disc still cannot be ejected, consult your Alpine dealer.*

### PROTECT

- A copy-protected WMA file was played back.
  - You can only play back non-copy-protected files.

### UNSUPPORT

(CDA-9815/CDA-9813)

### UNSUPPORT

(CDA-9811)

- The disc is not written in a MP3/WMA supported format.
  - Use a disc written at the MP3/WMA supported format.

## Indication for CD Changer

### HIGH TEMP

(CDA-9815)

### HI TEMP

(CDA-9813/CDA-9811)

- Protective circuit is activated due to high temperature.
  - The indicator will disappear when the temperature returns to within operation range.

### ERROR - 01

- Malfunction in the CD Changer.
  - Consult your Alpine dealer. Press the magazine eject button and pull out the magazine. Check the indication. Insert the magazine again. If the magazine cannot be pulled out, consult your Alpine dealer.
- Magazine ejection not possible.
  - Press the magazine eject button. If the magazine does not eject, consult your Alpine dealer.

### ERROR - 02

- A disc is left inside the CD Changer.
  - Press the eject button to activate the eject function. When the CD Changer finishes the eject function, insert an empty CD magazine into the CD Changer to receive the disc left inside the CD Changer.

### NO MAGAZINE

(CDA-9815)

### NO MAGZINE

(CDA-9813)

### NO MAGZN

(CDA-9811)

- No magazine is loaded into the CD Changer.
  - Insert a magazine.

## NO DISC

- No indicated disc.
  - Choose another disc.

## Indication for XM Radio Mode

## ANTENNA

- The XM antenna is not connected to the XM radio module.
  - Check whether the XM antenna cable is attached securely to the XM radio module.

## UPDATING

- Radio is being updated with latest encryption code.
  - Wait until encryption code is being updated. Channels 0 and 1 should function normally.

## NO SIGNAL

(CDA-9815/CDA-9813)

## NO SIGNAL

(CDA-9811)

- XM signal is too weak at the current location.
  - Wait until the car reaches a location with a stronger signal.

## LOADING

- Radio is acquiring audio or program information.
  - Wait until the radio has received the information.

## OFF AIR

- The channel currently selected has stopped broadcasting.
  - Select another channel.



(CDA-9815)

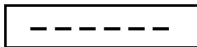

(CDA-9813)

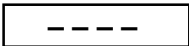

(CDA-9811)

- The user has selected a channel number that does not exist or is not subscribed to.
  - The unit will revert back to the previously selected channel.
- There is no artist name/feature, song/program title, or additional information associated with the channel at that time.
  - No action needed.

## Specifications

### FM TUNER SECTION

Tuning Range	87.7 – 107.9 MHz
Mono Usable Sensitivity	9.3 dBf (0.8 $\mu$ V/75 ohms)
50 dB Quieting Sensitivity	13.5 dBf (1.3 $\mu$ V/75 ohms)
Alternate Channel Selectivity	80 dB
Signal-to-Noise Ratio	80 dB
Stereo Separation	45 dB
Capture Ratio	2.0 dB

### AM TUNER SECTION

Tuning Range	530 – 1,710 kHz
Sensitivity (IEC Standard)	22.5 $\mu$ V/27 dB

### CD PLAYER SECTION

Frequency Response	5 – 20,000 Hz ( $\pm$ 1 dB)
Wow & Flutter (% WRMS)	Below measurable limits
Total Harmonic Distortion	0.008% (at 1 kHz)
Dynamic Range	95 dB (at 1 kHz)
Signal-to-Noise Ratio	105 dB
Channel Separation	85 dB (at 1 kHz)

### PICKUP

Wave length	795 nm
Laser power	CLASS I

### REMOTE CONTROL

Battery Type	AAA batteries (2 pcs.)
Width	42 mm (1-21/32")
Height	121 mm (4-25/32")
Depth	23 mm (29/32")
Weight	50 g (1.8 oz)

### GENERAL

Power Requirement	14.4 V DC (11–16 V allowable)
Maximum Power Output	60 W $\times$ 4 (CDA-9815/ CDA-9813) 50W $\times$ 4 (CDA-9811)
Maximum Pre-Output Voltage	4 V/10 k ohms
Bass (CDA-9811 only)	$\pm$ 14 dB at 60 Hz
Treble (CDA-9811 only)	$\pm$ 14 dB at 10 kHz
Weight	CDA-9815/CDA-9813 1.7 kg (3 lbs. 12 oz) CDA-9811 1.5 kg (3 lbs. 5 oz)

### CHASSIS SIZE

Width	178 mm (7")
Height	50 mm (2")
Depth	CDA-9815/CDA-9813 155 mm (6-1/8") CDA-9811 160 mm (6-1/4")

### NOSEPIECE SIZE

Width	170 mm (6-11/16")
Height	46 mm (1-13/16")
Depth	20 mm (25/32")

- Due to continuous product improvement, specifications and design are subject to change without notice.

---

# Installation and Connections

---

Before installing or connecting the unit, please read the following and pages 3 to 5 of this manual thoroughly for proper use.

## Warning

---

### **MAKE THE CORRECT CONNECTIONS.**

Failure to make the proper connections may result in fire or product damage.

### **USE ONLY IN CARS WITH A 12 VOLT NEGATIVE GROUND.**

(Check with your dealer if you are not sure.) Failure to do so may result in fire, etc.

### **BEFORE WIRING, DISCONNECT THE CABLE FROM THE NEGATIVE BATTERY TERMINAL.**

Failure to do so may result in electric shock or injury due to electrical shorts.

### **DO NOT ALLOW CABLES TO BECOME ENTANGLED IN SURROUNDING OBJECTS.**

Arrange wiring and cables in compliance with the manual to prevent obstructions when driving. Cables or wiring that obstruct or hang up on places such as the steering wheel, gear lever, brake pedals, etc. can be extremely hazardous.

### **DO NOT SPLICE INTO ELECTRICAL CABLES.**

Never cut away cable insulation to supply power to other equipment. Doing so will exceed the current carrying capacity of the wire and result in fire or electric shock.

### **DO NOT DAMAGE PIPE OR WIRING WHEN DRILLING HOLES.**

When drilling holes in the chassis for installation, take precautions so as not to contact, damage or obstruct pipes, fuel lines, tanks or electrical wiring. Failure to take such precautions may result in fire.

### **DO NOT USE BOLTS OR NUTS IN THE BRAKE OR STEERING SYSTEMS TO MAKE GROUND CONNECTIONS.**

Bolts or nuts used for the brake or steering systems (or any other safety-related system), or tanks should NEVER be used for installations or ground connections. Using such parts could disable control of the vehicle and cause fire etc.

### **KEEP SMALL OBJECTS SUCH AS BATTERIES OUT OF THE REACH OF CHILDREN.**

Swallowing them may result in serious injury. If swallowed, consult a physician immediately.

### **DO NOT INSTALL IN LOCATIONS WHICH MIGHT HINDER VEHICLE OPERATION, SUCH AS THE STEERING WHEEL OR GEARSHIFT.**

Doing so may obstruct forward vision or hamper movement etc. and results in serious accident.

## Caution

---

### **HAVE THE WIRING AND INSTALLATION DONE BY EXPERTS.**

The wiring and installation of this unit requires special technical skill and experience. To ensure safety, always contact the dealer where you purchased this product to have the work done.

### **USE SPECIFIED ACCESSORY PARTS AND INSTALL THEM SECURELY.**

Be sure to use only the specified accessory parts. Use of other than designated parts may damage this unit internally or may not securely install the unit in place. This may cause parts to become loose resulting in hazards or product failure.

### **ARRANGE THE WIRING SO IT IS NOT CRIMPED OR PINCHED BY A SHARP METAL EDGE.**

Route the cables and wiring away from moving parts (like the seat rails) or sharp or pointed edges. This will prevent crimping and damage to the wiring. If wiring passes through a hole in metal, use a rubber grommet to prevent the wire's insulation from being cut by the metal edge of the hole.

### **DO NOT INSTALL IN LOCATIONS WITH HIGH MOISTURE OR DUST.**

Avoid installing the unit in locations with high incidence of moisture or dust. Moisture or dust that penetrates into this unit may result in product failure.

## Precautions

---

- Be sure to disconnect the cable from the (-) battery post before installing your CDA-9815/CDA-9813/CDA-9811. This will reduce any chance of damage to the unit in case of a short-circuit.
- Be sure to connect the color coded leads according to the diagram. Incorrect connections may cause the unit to malfunction or damage to the vehicle's electrical system.
- When making connections to the vehicle's electrical system, be aware of the factory installed components (e.g. on-board computer). Do not tap into these leads to provide power for this unit. When connecting the CDA-9815/CDA-9813/CDA-9811 to the fuse box, make sure the fuse for the intended circuit of the CDA-9815/CDA-9813/CDA-9811 has the appropriate amperage. Failure to do so may result in damage to the unit and/or the vehicle. When in doubt, consult your ALPINE dealer.
- The CDA-9815/CDA-9813/CDA-9811 uses female RCA-type jacks for connection to other units (e.g. amplifier) having RCA connectors. You may need an adaptor to connect other units. If so, please contact your authorized ALPINE dealer for assistance.
- Be sure to connect the speaker (-) leads to the speaker (-) terminal. Never connect left and right channel speaker cables to each other or to the vehicle body.

## IMPORTANT

Please record the serial number of your unit in the space provided below and keep it as a permanent record. The serial number plate is located on the bottom of the unit.

SERIAL NUMBER: \_\_\_\_\_  
INSTALLATION DATE: \_\_\_\_\_  
INSTALLATION TECHNICIAN: \_\_\_\_\_  
PLACE OF PURCHASE: \_\_\_\_\_

# Installation

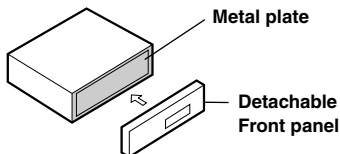

**Caution**

When you install this unit in your car, do not remove the detachable front panel. If the detachable front panel is removed during installation, you might press too hard and warp the metal plate that holds it in place.

**Caution**

Do not block the unit's fan or heat sink, thus preventing air circulation. If blocked, heat will accumulate inside the unit and may cause a fire.

Air ventilation hole

Air ventilation hole

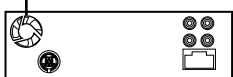

(Rear of CDA-9811)

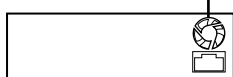

(Rear of CDA-9813/CDA-9815)

1

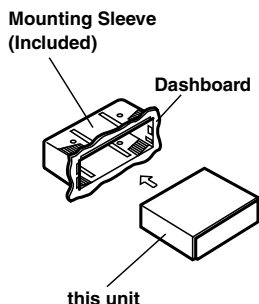

Slide the mounting sleeve into the dashboard.

2

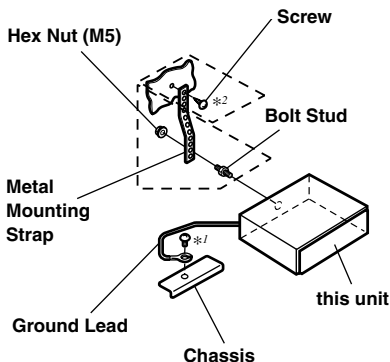

Reinforce the head unit with the metal mounting strap (not supplied). Secure the ground lead of the unit to a clean metal spot using a screw (\*1) already attached to the vehicle's chassis.

• For the screw marked “\*2”, use an appropriate screw for the chosen mounting location.

Connect each input lead coming from an amplifier or equalizer to the corresponding output lead coming from the left rear of the CDA-9815/CDA-9813/CDA-9811. Connect all other leads of the CDA-9815/CDA-9813/CDA-9811 according to details described in the CONNECTIONS section.

3

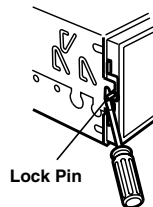

Slide the CDA-9815/CDA-9813/CDA-9811 into the dashboard. When the unit is in place, make sure the locking pins are fully seated in the down position. This can be done by pressing firmly in on the unit while pushing the locking pin down with a small screwdriver. This ensures that the unit is properly locked and will not accidentally come out from the dashboard. Install the detachable front panel.

**Removal**

- 1 Remove the detachable front panel.
- 2 Use a small screwdriver (or similar tool) to push the locking pins to the “up” position (see above drawing). As each pin is unlocked, gently pull out on the unit to make sure it does not re-lock before unlocking the second pin.
- 3 Pull the unit out, keeping it unlocked as you do so.

**<JAPANESE CAR>**

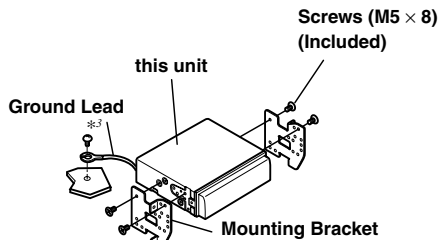
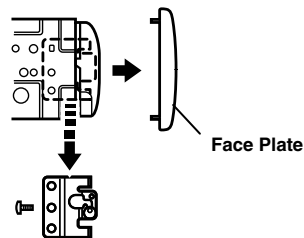

• Secure the ground lead of the unit to a clean metal spot using a screw (\*2) already attached to the vehicle's chassis.

# Connections for CDA-9811

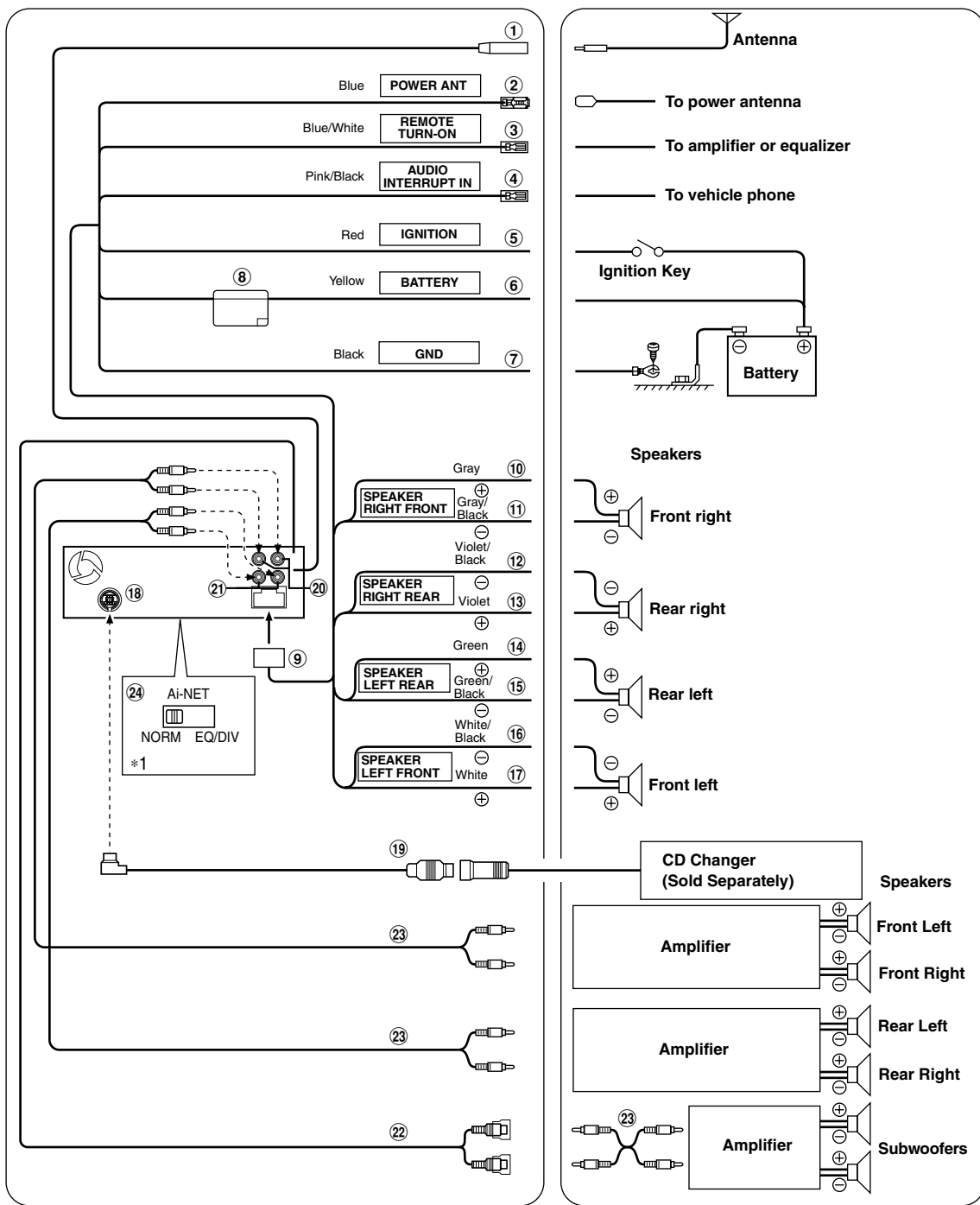

\* 1 The label is attached on the bottom of the unit.

- ① Antenna Receptacle
- ② Power Antenna Lead (Blue)  
Connect this lead to the +B terminal of your power antenna, if applicable.  
*This lead should be used only for controlling the vehicle's power antenna. Do not use this lead to turn on an amplifier, or a signal processor, etc.*
- ③ Remote Turn-On Lead (Blue/White)  
Connect this lead to the remote turn-on lead of your amplifier or signal processor.
- ④ Audio Interrupt In Lead (Pink/Black)
- ⑤ Switched Power Lead (Ignition) (Red)  
Connect this lead to an open terminal on the vehicle's fuse box or another unused power source which provides (+)12V only when the ignition is turned on or in the accessory position.
- ⑥ Battery Lead (Yellow)  
Connect this lead to the positive (+) post of the vehicle's battery.
- ⑦ Ground Lead (Black)  
Connect this lead to a good chassis ground on the vehicle. Make sure the connection is made to bare metal and is securely fastened using the sheet metal screw provided.
- ⑧ Choke Coil with Fuse Holder (15A)
- ⑨ Power Supply Connector
- ⑩ Right Front (+) Speaker Output Lead (Gray)
- ⑪ Right Front (-) Speaker Output Lead (Gray/Black)
- ⑫ Right Rear (-) Speaker Output Lead (Violet/Black)
- ⑬ Right Rear (+) Speaker Output Lead (Violet)
- ⑭ Left Rear (+) Speaker Output Lead (Green)
- ⑮ Left Rear (-) Speaker Output Lead (Green/Black)
- ⑯ Left Front (-) Speaker Output Lead (White/Black)
- ⑰ Left Front (+) Speaker Output Lead (White)
- ⑱ Ai-NET Connector  
Connect this to the output or input connector of another device (CD Changer, Equalizer, etc.) equipped with Ai-NET.  
*You can input TV/video sound by connecting an optional Ai-NET/RCA Interface cable (KCA-121B) to this component.*
- ⑲ Ai-NET Cable (Included with CD Changer)
- ⑳ Front Output RCA Connectors  
RED is right and WHITE is left.
- ㉑ Rear Output RCA Connectors  
RED is right and WHITE is left.
- ㉒ Subwoofer RCA Connectors  
RED is right and WHITE is left.
- ㉓ RCA Extension Cable (sold separately)
- ㉔ System Switch  
When connecting a processor or divider using Ai-NET, place this switch in the EQ/DIV position. When no device is connected, leave the switch in the NORM position.  
*Be sure to turn the power off to the unit before changing the switch position.*

**To prevent noise/interference in the audio system.**

- Locate the unit and route the leads at least 10 cm away from the car harness.
- Keep the battery power leads as far away from other leads as possible.
- Connect the ground lead securely to a bare metal spot (remove any paint, dirt or grease if necessary) of the car chassis.
- If you add an optional noise suppressor, connect it as far away from the unit as possible. Your Alpine dealer carries various noise suppressors, contact them for further information.
- Your Alpine dealer knows best about noise prevention measures so consult your dealer for further information.

# Connections for CDA-9815/CDA-9813

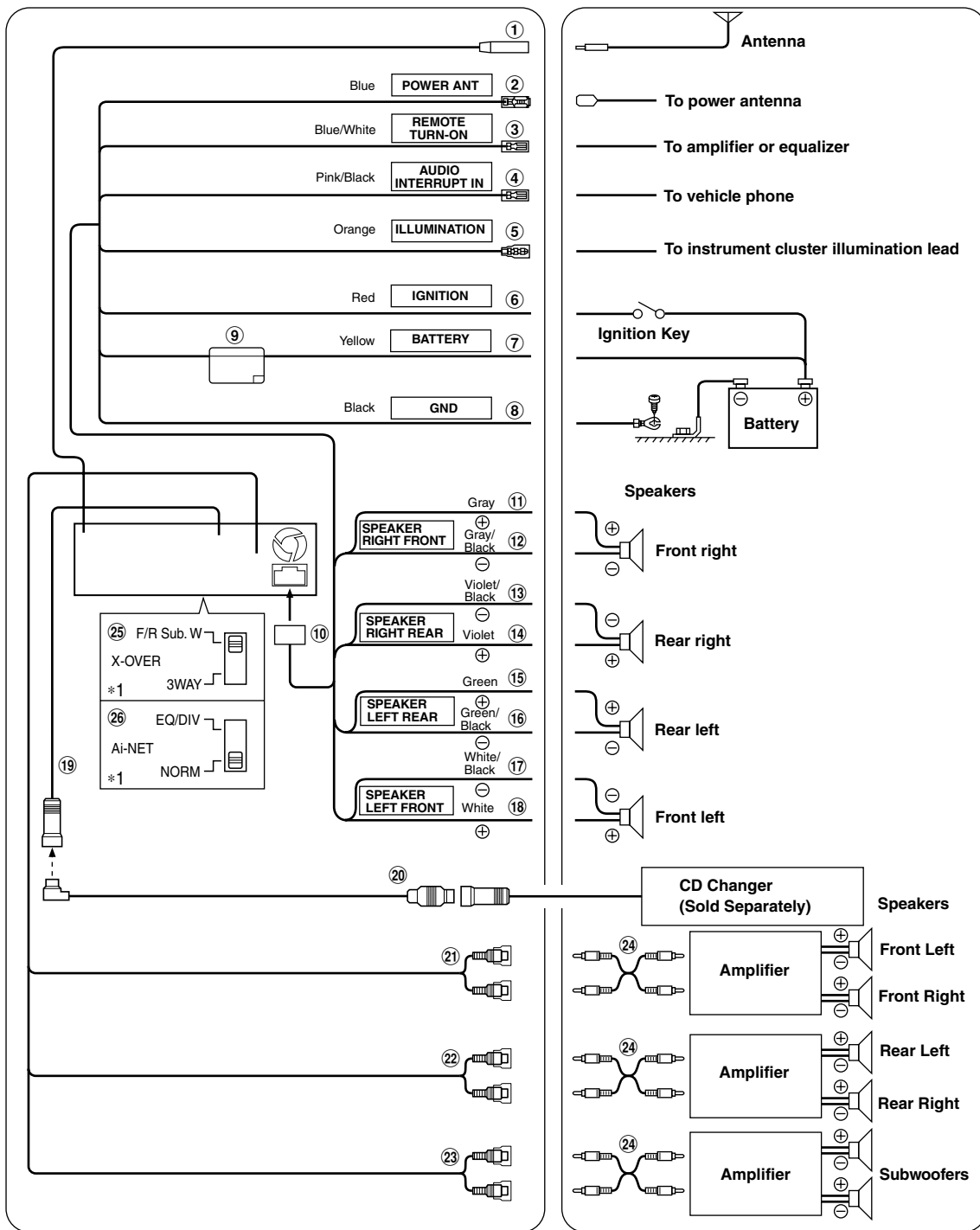

\* 1 The label is attached on the bottom of the unit.



- ① Antenna Receptacle
- ② Power Antenna Lead (Blue)  
Connect this lead to the +B terminal of your power antenna, if applicable.  
*This lead should be used only for controlling the vehicle's power antenna. Do not use this lead to turn on an amplifier, or a signal processor, etc.*
- ③ Remote Turn-On Lead (Blue/White)  
Connect this lead to the remote turn-on lead of your amplifier or signal processor.
- ④ Audio Interrupt In Lead (Pink/Black)
- ⑤ Illumination Lead (Orange)  
This lead may be connected to the vehicle's instrument cluster illumination lead. This will allow the backlighting of the unit to dim whenever the vehicle's lights are turned on.
- ⑥ Switched Power Lead (Ignition) (Red)  
Connect this lead to an open terminal on the vehicle's fuse box or another unused power source which provides (+)12V only when the ignition is turned on or in the accessory position.
- ⑦ Battery Lead (Yellow)  
Connect this lead to the positive (+) post of the vehicle's battery.
- ⑧ Ground Lead (Black)  
Connect this lead to a good chassis ground on the vehicle. Make sure the connection is made to bare metal and is securely fastened using the sheet metal screw provided.
- ⑨ Choke Coil with Fuse Holder (20A)
- ⑩ Power Supply Connector
- ⑪ Right Front (+) Speaker Output Lead (Gray)
- ⑫ Right Front (-) Speaker Output Lead (Gray/Black)
- ⑬ Right Rear (-) Speaker Output Lead (Violet/Black)
- ⑭ Right Rear (+) Speaker Output Lead (Violet)
- ⑮ Left Rear (+) Speaker Output Lead (Green)
- ⑯ Left Rear (-) Speaker Output Lead (Green/Black)
- ⑰ Left Front (-) Speaker Output Lead (White/Black)
- ⑱ Left Front (+) Speaker Output Lead (White)
- ⑲ Ai-NET Connector  
Connect this to the output or input connector of other product (CD Changer, Equalizer, etc.) equipped with Ai-NET.  
*You can input TV/video sound by connecting an optional Ai-NET/RCA Interface cable (KCA-121B) to this component.*
- ⑳ Ai-NET Cable (Included with CD Changer)
- ㉑ Front Output RCA Connectors  
RED is right and WHITE is left.
- ㉒ Rear Output RCA Connectors  
RED is right and WHITE is left.
- ㉓ Subwoofer RCA Connectors  
RED is right and WHITE is left.
- ㉔ RCA Extension Cable (Sold Separately)
- ㉕ Setting the 3WAY/2 WAY switch  
Set the 3way/2way switch according to your audio system.
- ㉖ System Switch  
When connecting a processor or divider using Ai-NET, place this switch in the EQ/DIV position. When no device is connected, leave the switch in the NORM position.  
*Be sure to turn the power off to the unit before changing the switch position.*

The X-Over Switch position for a two-way system (frequency range is divided between highs for front/rear and lows for the Subwoofer).

**The position of the X-Over switch : F/R/Sub-W**

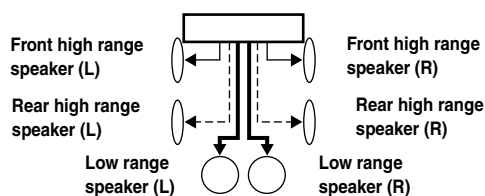

The X-Over Switch position for a three-way system whose frequency range is divided among the highs (Front), mids (Rear), and lows (Subwoofer).

**The position of the X-Over switch: 3WAY**

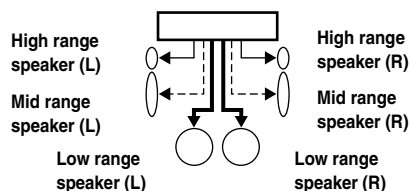

**Output of this unit :**

————— Front output      - - - - - Rear output      ——— SUB-W output

- Use the SUB-W output cord to connect the unit to the low range speaker.
- You can use the built-in amplifier to output the front output/rear output.
- You cannot adjust the fader when set to 3WAY.

**To prevent noise/interference in the audio system.**

- Locate the unit and route the leads at least 10 cm away from the car harness.
- Keep the battery power leads as far away from other leads as possible.
- Connect the ground lead securely to a bare metal spot (remove any paint, dirt or grease if necessary) of the car chassis.
- If you add an optional noise suppressor, connect it as far away from the unit as possible. Your Alpine dealer carries various noise suppressors, contact them for further information.
- Your Alpine dealer knows best about noise prevention measures so consult your dealer for further information.



# LIMITED WARRANTY

ALPINE ELECTRONICS OF AMERICA, INC. AND ALPINE OF CANADA INC. ("Alpine"), are dedicated to quality craftsmanship and are pleased to offer this Warranty. We suggest that you read it thoroughly. Should you have any questions, please contact your Dealer or Alpine at one of the telephone numbers listed below.

## ●PRODUCTS COVERED:

This Warranty covers Car Audio/Visual Products and Related Accessories ("the product"). Products purchased in the Canada are covered only in the Canada. Products purchased in the U.S.A. are covered only in the U.S.A.

## ●LENGTH OF WARRANTY:

This Warranty is in effect for one year from the date of the first consumer purchase.

## ●LIFETIME TAPE HEAD WARRANTY:

All Alpine Car Audio analog tape heads excluding Video tape heads are warranted for life against manufacturing defects causing failure.

## ●WHO IS COVERED:

This Warranty only covers the original purchaser of the product, who must reside in the United States, Puerto Rico or Canada.

## ●WHAT IS COVERED:

This Warranty covers defects in materials or workmanship (parts and labor) in the product.

## ●WHAT IS NOT COVERED:

This Warranty does not cover the following:

- ① Damage occurring during shipment of the product to Alpine for repair (claims must be presented to the carrier).
- ② Damage caused by accident, abuse, negligence, misuse, improper connections, improper operation or failure to follow instructions contained in the Owner's manual.
- ③ Damage caused by act of God, including without limitation, earthquake, fire, flood, storms or other acts of nature.
- ④ Any cost or expense related to the removal or reinstallation of the product.
- ⑤ Service performed by an unauthorized person, company or association.
- ⑥ Any product which has the serial number defaced, altered or removed.
- ⑦ Any product which has been adjusted, altered or modified without Alpine's consent.
- ⑧ Any product not distributed by Alpine within the United States, Puerto Rico or Canada.
- ⑨ Any product not purchased from an Authorized Alpine Dealer.
- ⑩ Any product that has been determined to contain an excessive amount of dust or dirt and any product that contains other contaminants including liquid or foreign objects.

## ●HOW TO OBTAIN WARRANTY SERVICE:

- ① You are responsible for delivery of the product to an Authorized Alpine Service Center or Alpine for repair and for payment of any initial shipping charges. Alpine will, at its option, repair or replace the product with a new or reconditioned product without charge. If the repairs are covered by the warranty, and if the product was shipped to an Authorized Alpine Service Center or Alpine, Alpine will pay the return shipping charges.

- ② You should provide a detailed description of the problem(s) for which service is required.

- ③ You must supply proof of your purchase of the product.

- ④ You must package the product securely to avoid damage during shipment.

## ●HOW WE LIMIT IMPLIED WARRANTIES:

ANY IMPLIED WARRANTIES INCLUDING FITNESS FOR USE AND MERCHANTABILITY ARE LIMITED IN DURATION TO THE PERIOD OF THE EXPRESS WARRANTY SET FORTH ABOVE AND NO PERSON IS AUTHORIZED TO ASSUME FOR ALPINE ANY OTHER LIABILITY IN CONNECTION WITH THE SALE OF THE PRODUCT.

## ●HOW WE EXCLUDE CERTAIN DAMAGES:

ALPINE EXPRESSLY DISCLAIMS LIABILITY FOR INCIDENTAL AND CONSEQUENTIAL DAMAGES CAUSED BY THE PRODUCT. THE TERM "INCIDENTAL DAMAGES" REFERS TO EXPENSES OF TRANSPORTING THE PRODUCT TO THE ALPINE SERVICE CENTER, LOSS OF THE ORIGINAL PURCHASER'S TIME, LOSS OF THE USE OF THE PRODUCT, BUS FARES, CAR RENTALS OR OTHERS COSTS RELATING TO THE CARE AND CUSTODY OF THE PRODUCT. THE TERM "CONSEQUENTIAL DAMAGES" REFERS TO THE COST OF REPAIRING OR REPLACING OTHER PROPERTY WHICH IS DAMAGED WHEN THIS PRODUCT DOES NOT WORK PROPERLY. THE REMEDIES PROVIDED UNDER THIS WARRANTY ARE EXCLUSIVE AND IN LIEU OF ALL OTHERS.

## ●HOW STATE/PROVINCIAL LAW RELATES TO THE WARRANTY:

This Warranty gives you specific legal rights, and you may also have other rights which vary from state to state and province to province. In addition, some states/provinces do not allow limitations on how long an implied warranty lasts, and some do not allow the exclusion or limitation of incidental or consequential damages. Accordingly, limitations as to these matters contained herein may not apply to you.

## ●IN CANADA ONLY:

This Warranty is not valid unless your Alpine car audio product has been installed in your vehicle by an Authorized Installation Center, and this warranty stamped upon installation by the installation center.

## ●HOW TO CONTACT CUSTOMER SERVICE:

Should the product require service, please call the following number for your nearest Authorized Alpine Service Center.

U.S.A.	1-800-ALPINE-1 (1-800-257-4631)
CANADA	1-800-ALPINE-1 (1-800-257-4631)

Alpine Electronics of America, Inc., 19145 Gramercy Place, Torrance, California 90501, U.S.A.

Alpine Electronics of Canada, Inc., Suite 203, 7300 Warden Ave. Markham, Ontario, L3R 9Z6, Canada