

aiwa

XP-SR311

COMPACT DISC PLAYER

OPERATING INSTRUCTIONS

AIWA CO.,LTD.

8A-HCD-901-01
000317AYO-OX
Printed in China

NOTE FOR USE IN THE U.S.A.

This equipment has been tested and found to comply with the limits for a Class B digital device, pursuant to Part 15 of the FCC Rules. These limits are designed to provide reasonable protection against harmful interference in a residential installation.

This equipment generates, uses, and can radiate radio frequency energy and, if not installed and used in accordance with the instructions, may cause harmful interference to radio communications. However, there is no guarantee that interference will not occur in a particular installation. If this equipment does cause harmful interference to radio or television reception, which can be determined by turning the equipment off and on, the user is encouraged to try to correct the interference by one or more of the following measures:

- Reorient or relocate the receiving antenna.
- Increase the separation between the equipment and receiver.
- Connect the equipment into an outlet on circuit different from that to which the receiver is connected.
- Consult the dealer or an experienced radio/TV technician for help.

CAUTION

Modifications or adjustments to this product, which are not expressly approved by the manufacturer, may void the user's right or authority to operate this product.

OWNER'S RECORD

For your convenience, record the model number and the serial number (you will find it on the bottom of your set) in the space provided below. Please refer to them when you contact your Aiwa dealer in case of difficulty.

Model No. XP-SR311

Serial No.

Highlighted letters in the text of this manual correspond to the illustrations.

PRECAUTIONS

To maintain good performance

- Do not use the unit in places which are extremely hot, cold, dusty or humid. In particular, do not use or keep the unit in following places.
 - in a high humidity area such as a bathroom
 - near a heater
 - in an area exposed to direct sunlight (e.g., inside a parked car, where it can become extremely hot)
 - near sources of strong magnetism, such as televisions, speakers, or magnets
 - where there is a lot of movement or vibration, such as on a car dashboard or an unstable shelf
- Do not open the battery compartment with wet hands.
- Wipe the unit thoroughly before inserting batteries and after use.
- Do not soak the unit in water.

For safety

- Do not attempt to disassemble the unit. Laser rays from the optical pickup are dangerous to the eyes.
- Make sure that pins or other foreign object do not get inside the player.
- Take care not to drop the unit or subject it to strong shocks.
- To keep dust from the pickup lens, keep the disc compartment lid closed after use. Never touch the lens.
- If you hear no sound when playing a disc, DO NOT turn the volume up high because music could suddenly start at high volume. Turn the volume control to the lowest level before starting playback and slowly turn it up to the desired level.

Note on listening with the headphones

- Listen at moderate volumes to avoid hearing damage.
- Do not wear the headphones while driving or cycling. It may create a traffic hazard.
- You should use extreme caution or temporarily discontinue use in potentially hazardous situations, such as walking, jogging, etc.
- Wear them properly; L is left, R is right.

Note on condensation

If the unit is suddenly moved from a cold place to a warm one, it may result in condensation on the pickup lens and malfunction or playback difficulties. Should this occur, leave the unit for a few hours, then try to playback again.

If an erroneous operation occurs

Press ■STOP/OFF/CHARGE twice to turn off the power. Then turn the power back on to reset the unit.

USING ON DRY CELL BATTERIES → **A**

- 1** Set the dial to the OPEN position to open the disc compartment, then open the battery compartment.
- 2** Insert two size AA (LR6) alkaline batteries with the ⊕ and ⊖ marks correctly aligned. After battery insertion, close the battery compartment firmly.
- 3** Close the disc compartment tightly and set the dial to the LOCK position.

Battery replacement

The battery indicator in the display changes from to to according to the remaining power of the batteries. Replace the batteries when lights. If the unit remains in use after lights, "Lo-bAtt" is displayed and the operation will stop.

Battery life (using alkaline batteries LR6)

The mode of the E•A•S•S	Battery life
48	Approx. 20 hours
12 or OFF	Approx. 15 hours

Battery life may vary depending on conditions of use.

If the cover of the battery compartment comes off → **B**

Note

Close the battery compartment firmly, or the compact disc may be damaged.

Note on dry cell batteries

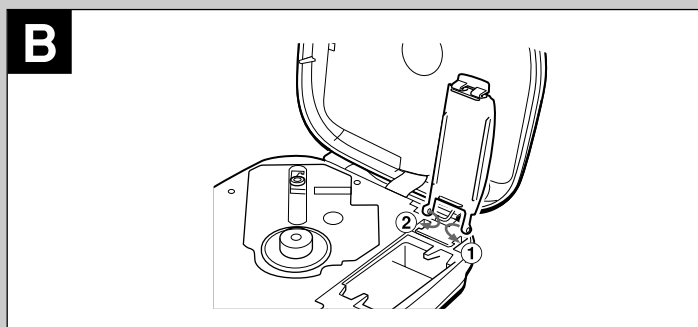
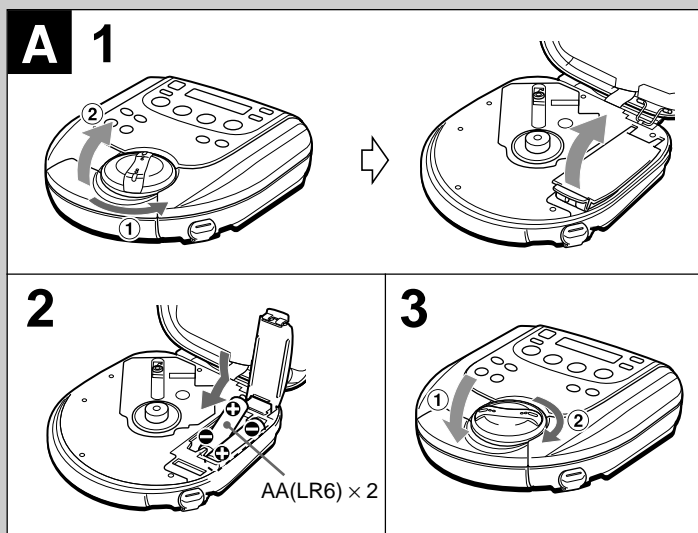

Note

Close the battery compartment firmly, or the compact disc may be damaged.

Note on dry cell batteries

- Make sure that the \oplus and \ominus marks are correctly aligned.
- Do not mix the different types of batteries, or an old battery with a new one.
- To prevent the risk of electrolyte leakage or explosions, never recharge the batteries, apply heat to them, or take them apart.
- When not using the batteries, remove them to prevent needless battery wear.
- If liquid leaks from the batteries, wipe thoroughly to remove.

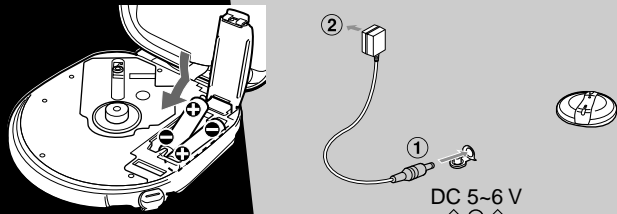

DC 5~6 V
⬡-C-⬡

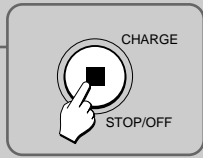
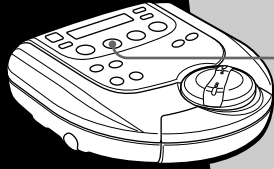

USI

- Be su...
- Be su...
- Be su...
- When...
- the bat...
- Before...
- charge...

1 Insert

2 Connect

3 Keep

start charge

After charging

Time to recharge

Recharge the battery

When

of the

AC adaptor.

to DC

to wall

used for about 1

“C-on” is dis

After charging

AC adaptor.

Recharge the battery

when

of the

D

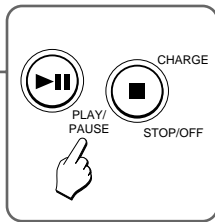
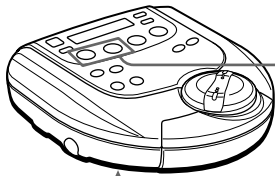
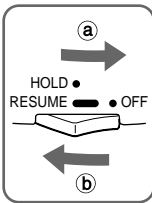

E

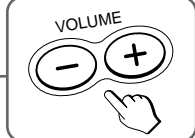
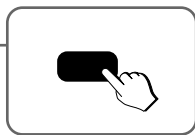
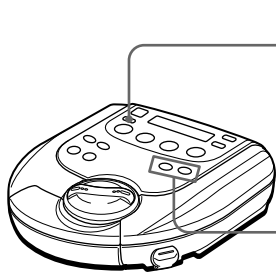

F

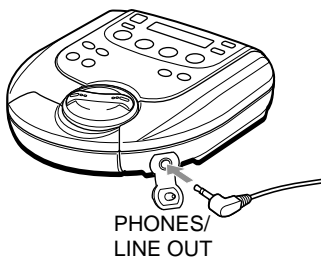

G

1

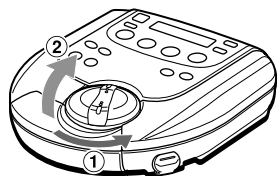

2

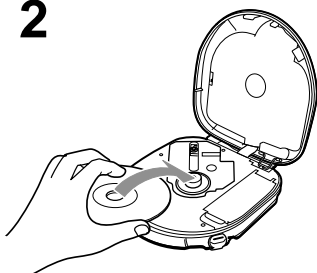

3





H

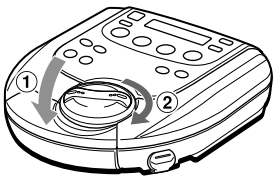
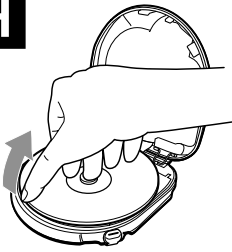

3**H****DSL**

Press DSL for more powerful sound and deeper bass.

DSL  : Deep bass is emphasized.

DSL  : Deep bass is strongly emphasized.

DSL  : Normal sound

Connecting the headphones → F

Pull out the rubber cap and connect the supplied headphones to the PHONES/LINE OUT jack.

Inserting a disc → G

1 Set the dial to the OPEN position to open the disc compartment.

2 Place a disc in the center with the label side facing up.

3 Close the disc compartment tightly and set the dial to the LOCK position.

To remove the disc → I

Pick up the disc, holding its edge, while pressing the pivot gently.

Note

- The unit may not play a CD-R/RW disc that is recorded on personal computers or some kinds of CD-R/RW recorders because of differences in recording platforms.
- Do not attach any seal or label to either side (the recordable side or the labeled side) of a CD-R/RW disc. It may cause malfunction.

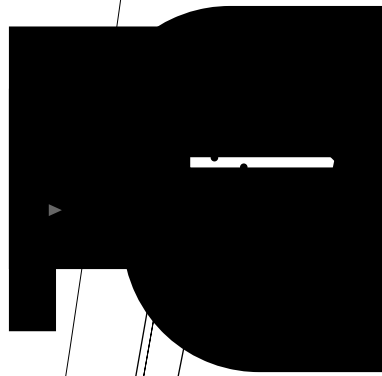

■ STOP/OFF/
CHARGE



PHONES/
LINE OUT

HOLD
RESUME ● OFF

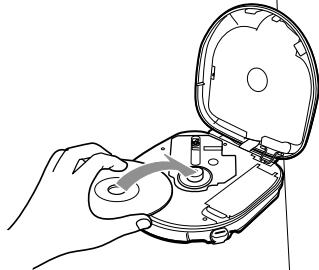

PLAY/
PAUSE

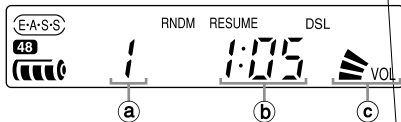

a

b

c

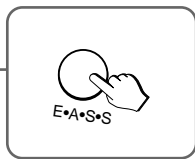
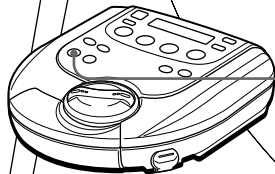

E•A•S•S

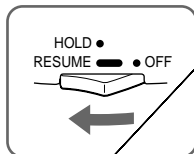

HOLD
RESUME ● OFF

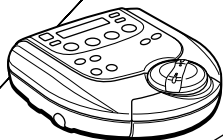

display changes to RNDM. PLAY MODE in standby mode.

Note

- You cannot back to previous track by pressing **⏮** during random play.
- You cannot select one-track repeat during random play.

Repeat play → **L**

Press PLAY MODE during playback to select repeat play as follows.

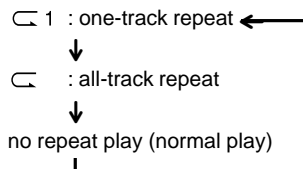

Note

When the unit is set to E•A•S•S-12 or -48 second mode, if PLAY MODE is pressed at the end of the track to select the other play mode, the unit may not change to the other mode properly.

L

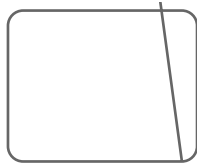
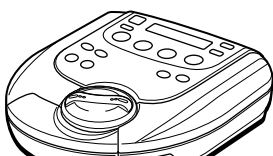

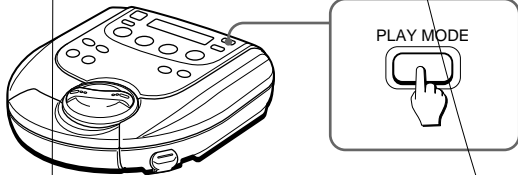

Note

When the unit is set to E•A•S•S-12 or -48 second mode, if PLAY MODE is pressed at the end of the track to select the other play mode, the unit may not change to the other mode properly.

RADIO RECEPTION

Tuning in to a station → M

- 1 Press TUNER ON/BAND repeatedly to select AM or FM.
- 2 Press TUNING + (▶▶) or - (◀◀) to tune in to a station.

After listening, press ■ STOP/OFF/CHARGE to turn off the radio.

For quick tuning

Keep either TUNING + (▶▶) or - (◀◀) pressed for about 1 second. When a station is tuned in to, the frequency stops automatically. However, it does not stop if the broadcast signal is weak.

For better reception → N

FM: The headphone cord functions as the FM antenna. Keep it extended.
 AM: Turn the unit to find the position which gives the best reception.

To listen to an FM stereo broadcasting

When a tuned in station is in stereo, ST changes to (ST). When the FM stereo signal is weak and distorted, press MONO/ST. ST goes out and the sound will be heard in monaural but distortion will be reduced.

Note

- Do not open the disc compartment during radio reception. The buttons will be deactivated.
- The power is turned off automatically if no operation is made after 180 minutes from the last operation during radio reception.

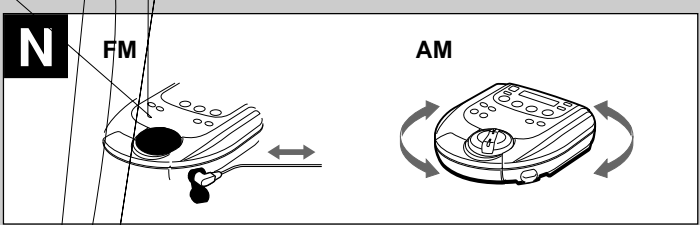
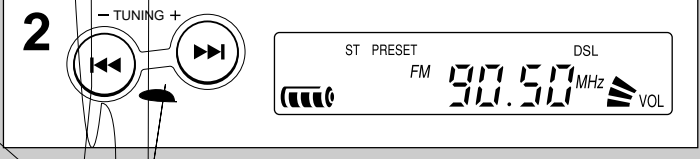
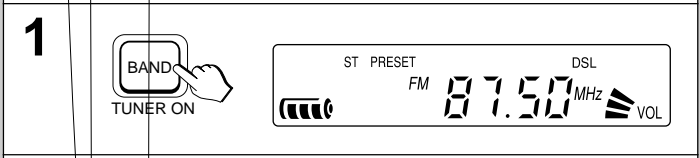
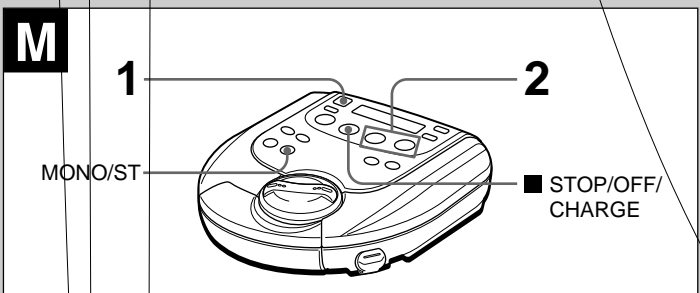

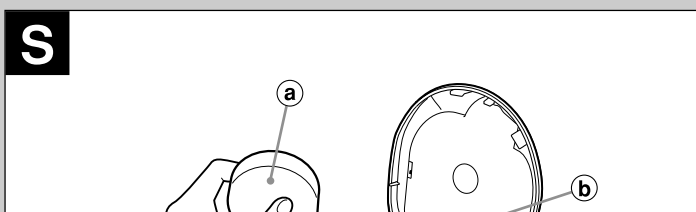
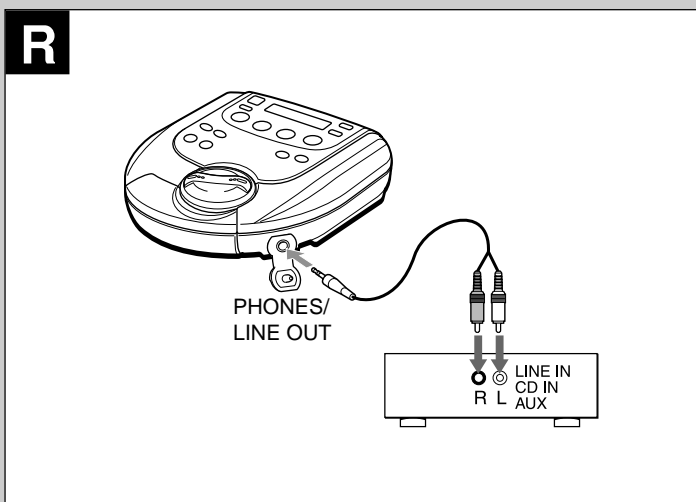
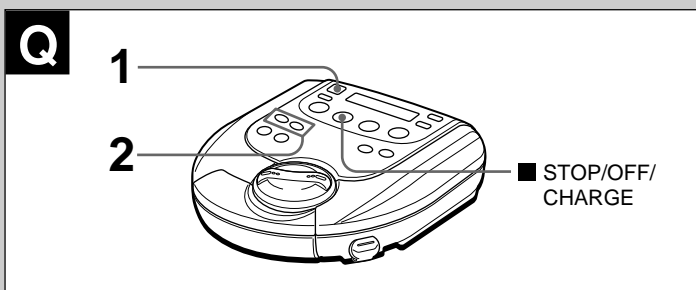
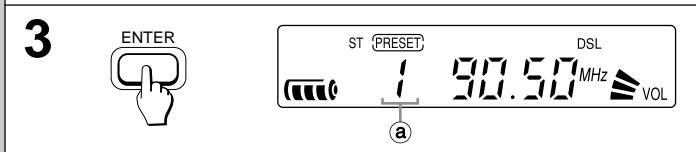
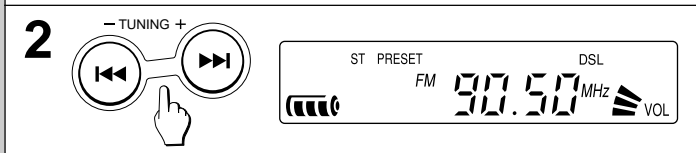
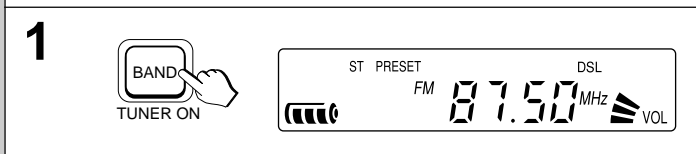
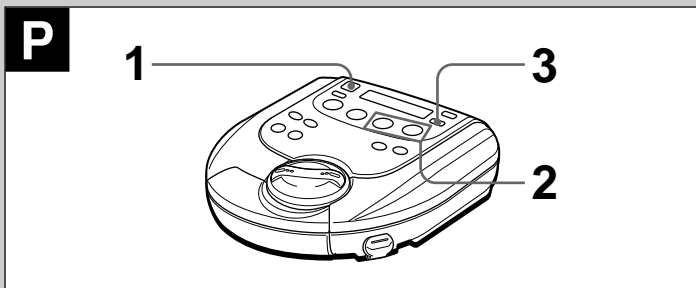
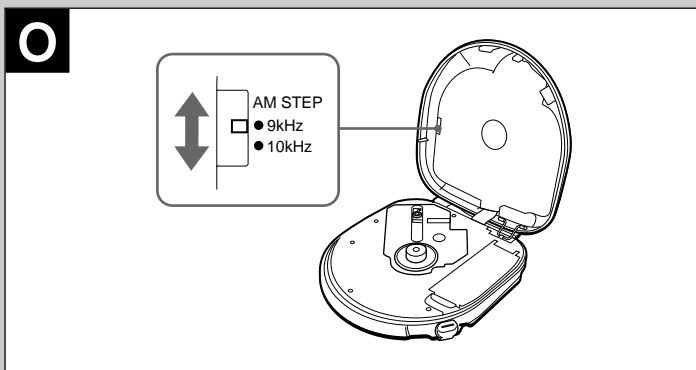

AM steps → O

Radio broadcasts have different frequency ranges and changes in different steps in different countries.

This unit is factory-set to 10 kHz steps on AM. When using the unit where the AM step changes to 9 kHz, set the AM STEP switch on the inner side of the disc compartment to 9 kHz.

- When the AM step is changed, stations that you preset are erased.

Presetting stations → P

You can preset up to total of 30 stations on AM and FM.

- 1 Press TUNER ON/BAND repeatedly to select AM or FM.
- 2 Press TUNING + (▶▶) or - (◀◀) to tune in to a station.
- 3 Press ENTER to preset the station.

Ⓐ Preset number

To preset more stations, repeat steps 2 and 3.

Listening to preset stations → Q

- 1 Press TUNER ON/BAND repeatedly to select AM or FM.
- 2 Press PRESET CALL ^/∨ repeatedly to select the preset number.

After listening, press ■ STOP/OFF/CHARGE to turn off the radio.

Changing the presetting

- 1 Press PRESET CALL ^/∨ repeatedly to select the preset number you wish to change.
- 2 Keep ENTER pressed for 1 or more seconds until the preset number and the frequency flash.
- 3 While the preset number is flashing, press TUNING + (▶▶) or - (◀◀) to tune in to a station.
- 4 Press ENTER to preset the station on the selected preset number.

If the flashing stops, repeat the procedure from step 2.

Erasing the presettings one by one

Press ■ STOP/OFF/CHARGE after step 2 in "Changing the presetting" above. Each preset station is erased. All the settings move up by one and the preset numbers are refreshed.

Erasing all of the presetting

Keep ENTER pressed, then press TUNER ON/BAND when the frequency and preset number starts flashing.

CONNECTING TO AN EXTERNAL UNIT → R

Use a commercially available connection cord which has a 3.5ø stereo mini-plug at one end and two phono plugs at the other end.

Connect the stereo mini-plug to the PHONES/LINE OUT jack of the unit and connect the phono plugs to the analog input terminals of the external unit.

Note

- Turn off the power of both units before connection.
- DO NOT connect to the PHONO inputs of an amplifier (with a built-in phonoequalizer-amplifier).
- Adjust the volume and DSL on this unit.

MAINTENANCE

To clean the lens → S

If the lens becomes dirty, the player will skip or not play. If this occurs, clean the lens in the following manner.

To remove dust or dry particles, first use a camera lens blower/brush Ⓐ to blow a few times to loosen particles, then gently brush the lens Ⓑ clean. Finish by blowing the lens again.

To remove fingerprints, use a cotton swab dipped in lens cleaning solution. Wipe gently from the center to the edge. Lens cleaning solution is commercially available.

Note

Take care not to get too much solution on the swab, which could flow into the unit and cause damage. Pressing too strongly with the swab could scratch or break the lens.

To clean the discs → T

Before playing, wipe the disc from the center outward with a cleaning cloth. After playing, store the disc in its case.

SPECIFICATIONS

Tracking system	3-beam laser
Laser pickup	Semiconductor laser

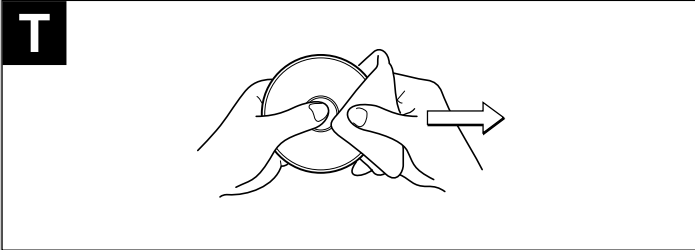
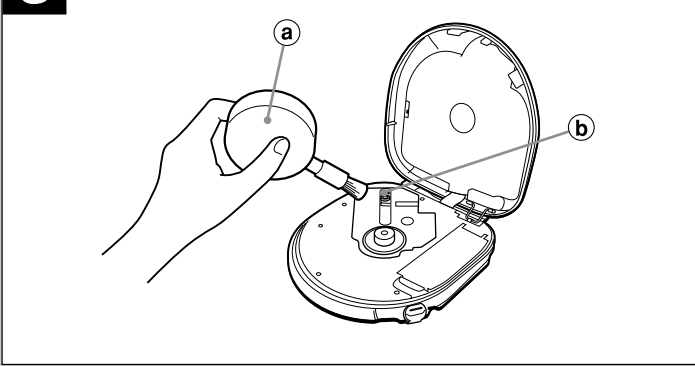

SPECIFICATIONS

Tracking system	3-beam laser
Laser pickup	Semiconductor laser
D/A conversion	4-times oversampling digital filter + 1-bit DAC
Frequency response	20 – 20,000 Hz (47 k ohms)
Output	PHONES/LINE OUT jack (stereo mini-jack)
Frequency range	AM: 530/531 kHz – 1,710/1,602 kHz (10 kHz/9 kHz steps) FM: 87.5 – 108 MHz
Maximum output	12 mW + 12 mW (16 ohms at 1 kHz) 500 mV (47 k ohms at 1 kHz)
Power supply	DC 3 V using two size AA (LR6) alkaline batteries DC 2.4 V using commercially available rechargeable batteries AC house current using the supplied AC adaptor
Maximum outside dimensions	132 (W) × 32.5 (H) × 141 (D) mm, 5 1/4 × 1 5/16 × 5 5/8 in. (excluding projecting parts and controls)
Weight	Approx. 280 g (9.8 oz.) excluding batteries
Accessories	AC adaptor AC-D603 (1) Stereo headphones (1) Carrying case (1)
AC adaptor AC-D603	Rated input: AC 120 V, 60 Hz

The specifications and external appearance of this unit are subject to change without notice.