



**Installing and Configuring the
Avaya S8500 Media Server
Release 4.0**

03-300143
Release 4.0
February 2007
Issue 5

© 2007 Avaya Inc.
All Rights Reserved.

Notice

While reasonable efforts were made to ensure that the information in this document was complete and accurate at the time of printing, Avaya Inc. can assume no liability for any errors. Changes and corrections to the information in this document may be incorporated in future releases.

For full legal page information, please see the documents, *Avaya Support Notices for Software Documentation*, 03-600758, and *Avaya Support Notices for Hardware Documentation*, 03-600759.

These documents can be accessed on the documentation CD and on the Web site, <http://www.avaya.com/support>. On the Web site, search for the document number in the Search box.

Documentation disclaimer

Avaya Inc. is not responsible for any modifications, additions, or deletions to the original published version of this documentation unless such modifications, additions, or deletions were performed by Avaya. Customer and/or End User agree to indemnify and hold harmless Avaya, Avaya's agents, servants and employees against all claims, lawsuits, demands and judgments arising out of, or in connection with, subsequent modifications, additions or deletions to this documentation to the extent made by the Customer or End User.

Link disclaimer

Avaya Inc. is not responsible for the contents or reliability of any linked Web sites referenced elsewhere within this documentation, and Avaya does not necessarily endorse the products, services, or information described or offered within them. We cannot guarantee that these links will work all of the time and we have no control over the availability of the linked pages.

Warranty

Avaya Inc. provides a limited warranty on this product. Refer to your sales agreement to establish the terms of the limited warranty. In addition, Avaya's standard warranty language, as well as information regarding support for this product, while under warranty, is available through the following Web site: <http://www.avaya.com/support>.

Copyright

Except where expressly stated otherwise, the Product is protected by copyright and other laws respecting proprietary rights. Unauthorized reproduction, transfer, and or use can be a criminal, as well as a civil, offense under the applicable law.

Avaya support

Avaya provides a telephone number for you to use to report problems or to ask questions about your product. The support telephone number is 1-800-242-2121 in the United States. For additional support telephone numbers, see the Avaya Web site: <http://www.avaya.com/support>.

Contents

Chapter 1: Introduction	7
Audience	7
How to use Avaya installation documents	8
Pre-installation requirements	9
Preinstallation tasks to complete at the customer site	9
Verifying that all the required equipment is on site	9
Ensuring that the preinstallation tasks are complete	10
S8500 hardware	10
Equipment specifications	13
About the Server Availability Management Processor	16
About SAMP functionality	16
About SAMP connections	16
About SAMP software	18
About media server port connections	19
S8500 port connections	19
About modem connections	21
Modem options	22
About media gateways	22
About Processor Ethernet	22
About S8500 LSP mode	24
S8500 LSP license file	25
About SSH	25
Chapter 2: SNMP Configuration	27
Configuring the SNMP modules in the UPS	27
Default IP addresses for the UPS	28
Prerequisites for configuring the SNMP module	28
Administering the SNMP module	29
Setting selected traps (alarming)	30
Configuring the SNMP subagent in the Avaya Ethernet switch (if used)	30
Default IP addresses for the Ethernet switch	31
Preparing to configure the Ethernet switch	31
Configuring the Ethernet switch	32
Chapter 3: Communication Manager installation	35
Clearing the ARP cache on the laptop	35
Applying power to the media server	36
Accessing the media server	36

Contents

Configuring Telnet for Windows 2000 and Windows XP	36
Installing Avaya Communication Manager	37
Chapter 4: Media server configuration.	39
Opening the Maintenance Web Interface.	40
Copying files to the media server	40
Creating a super-user login	40
About the Avaya Installation Wizard	41
Running the Avaya Installation Wizard.	42
Verifying the RMB IP information.	42
Installing SAMP firmware	42
Verifying the media server connection to the customer LAN (if provided)	43
Configuring the modem	43
Enabling firewall settings	44
Enabling network time servers	44
Checking LED activity on the dual NIC.	46
Configuring the NIC	46
Disconnecting from the media server	48
Chapter 5: IP interface translations	49
Inputting initial system translations	49
Adding media gateways	50
Enabling the IPSI.	51
Adding the IPSI to the system	52
Setting the alarm activation level	52
Saving translations	52
Chapter 6: IP interface configuration	53
Connecting to the IPSIs	53
IPSI address configuration	54
Programming the IPSI for static addressing	54
Setting the VLAN and diffserv parameters	57
Programming the IPSI for DHCP addressing	59
Verifying connectivity to the media server	61
Verifying that the IPSIs are translated	62
Upgrading the IPSI firmware version (if necessary)	62

Enabling control of the IPSIs	62
Verifying the license status	62
Chapter 7: Install an S8500 Media Server as an LSP	63
Configuring the media server as an LSP	63
Administering the primary controller	65
Enabling license server capability on a media gateway	65
Installing and verifying the license on the new LSP	66
Opening the TCP ports on the S8500 LSP	67
Resetting the S8500 LSP	67
Verifying that the primary controller identifies the new LSP	68
Readministering media gateways to point to the LSP	68
Chapter 8: Postinstallation administration	69
Verifying translations	69
Setting rules for daylight savings time	70
Setting locations (if necessary)	71
Verifying the date and the time	72
Clearing and resolving alarms	72
Enabling and disabling the Ethernet switch ports	73
Backing up files to the compact flash media	75
Enabling alarms to INADS by way of a modem	75
Enabling alarms to INADS by way of the SNMP module	76
Before leaving the site	76
Chapter 9: Installation verification	77
Testing the IPSI circuit pack	77
Testing the license file	77
S8500 LEDs	78
Additional media server LED information	80
Avaya C360 Ethernet switch LEDs	81
UPS LEDs	82
TN2312BP IPSI LEDs	83

Contents

Appendix A: Media server access	87
Accessing the command line interface of the server with SSH	87
Connecting to the media server directly	89
Connecting to the media server remotely over the network	91
Connecting to the media server remotely over a modem	91
Accessing the Maintenance Web Interface	92
Using the SAT command line prompt	93
Logins for Avaya technicians and BusinessPartners	93
Configuring the network for Windows 2000 and XP	94
Setting the browser options for Internet Explorer 6.0	95
Appendix B: Installation troubleshooting	97
Troubleshooting the installation of the media server hardware	97
Troubleshooting the configuration of the media server hardware	98
Troubleshooting the installation of the license file and the Avaya authentication file	100
Index	101

Chapter 1: Introduction

Use these procedures to install Avaya Communication Manager and configure a new Avaya S8500 Media Server and the associated components in an IP-connected port network (IP-PNC) configuration.

To configure the media server, use the Avaya Installation Wizard. To configure gateways and other hardware components, use the following two administration interfaces:

- The Maintenance Web Interface
- The command line interface, either directly or through Secure Shell (SSH), Telnet, or a terminal emulation program such as Avaya Native Configuration Manager.

This installation document includes the following information:

- [Pre-installation requirements](#) on page 9
- [Configuring the SNMP modules in the UPS](#) on page 27
- [Configuring the SNMP subagent in the Avaya Ethernet switch \(if used\)](#) on page 30
- [Media server configuration](#) on page 39
- [Configuring the NIC](#) on page 46
- [IP interface translations](#) on page 49
- [IP interface configuration](#) on page 53
- [Postinstallation administration](#) on page 69
- [Installation verification](#) on page 77
- [Media server access](#) on page 87
- [Installation troubleshooting](#) on page 97

Audience

This documentation is for the following people who install and configure the media server components:

- Trained field installation and maintenance personnel
- Technical support personnel
- Authorized business partners

How to use Avaya installation documents

Use this document as a guide to install and configure Avaya media servers. For information about a particular task, use the index or the table of contents to locate the page on which the information is described. You also need information from other Avaya documents. This section lists those documents and tells you when to use them.

To complete this installation:

- In this document, see:
 - [Pre-installation requirements](#) on page 9 first. This section describes the tasks that you must complete at the site before you start the installation.
 - [Equipment specifications](#) on page 13 for the technical specifications for the hardware.
- For how to install and connect the hardware, see *Quick Start for Hardware Installation: Avaya S8500 Media Server (555-245-701)*.
- For how to install an updated version of the Avaya Server Availability Management Processor (SAMP) and configure the SAMP, see *Using the Avaya Server Availability Management Processor (03-300322)*.
- Return to this document and see the remaining sections in the following sequence to install the components of the media server. If you are not to install certain components, skip the procedures for those components.
 - [Configuring the SNMP modules in the UPS](#) on page 27
 - [Configuring the SNMP subagent in the Avaya Ethernet switch \(if used\)](#) on page 30
 - [Media server configuration](#) on page 39
 - [Configuring the NIC](#) on page 46
 - [IP interface translations](#) on page 49

 **Important:**

If the S8500 Media Server is configured as an LSP, skip the following section.

- See the appropriate sections in the following documents to install the port networks and the media gateways:
 - *Installing the Avaya G650 Media Gateway (03-300144)*
 - *Installation and Configuration for the Avaya G150 Media Gateway (03-300395)*
 - *Quick Start for Hardware Installation: Avaya G250 Media Gateway (03-300433)*
 - *Quick Start for Hardware Installation: Avaya G350 Media Gateway (03-300148)*
 - *Installation of the Avaya G350 Media Gateway (555-245-104)*
 - *Quick Start for Hardware Installation: Avaya S8300 Media Server and Avaya G700 Media Gateway (555-233-150)*

- *Installation and Upgrades for the Avaya G700 Media Gateway and Avaya S8300 Media Server (555-234-100)*
- *Avaya IA 770 INTUITY AUDIX Messaging Application Administering the S8300 and S8400 Media Servers to work with IA 770*
- Return to this document and see:



Important:

If the S8500 Media Server is configured as an LSP, skip the following section.

- [IP interface configuration](#) on page 53 to program the IP interface.
- [Install an S8500 Media Server as an LSP](#) on page 63 if the S8500 Media Server is configured as an LSP.
- [Postinstallation administration](#) on page 69
- [Installation verification](#) on page 77
- [Media server access](#) on page 87
- [Installation troubleshooting](#) on page 97 if problems occur during the installation.

Pre-installation requirements

This section describes the tasks that you must complete before you start the installation. You complete certain tasks before you go on site and other tasks at the site.

Preinstallation tasks to complete at the customer site

Before you start the installation, you must:

- Verify that all the required equipment is on site
- Ensure that the preinstallation team completed the preinstallation tasks

Verifying that all the required equipment is on site

Compare the list of items that were ordered to the contents of the boxes to verify that you have all the equipment. Your project manager can give you an inventory list. Do not rely on the packing slips inside the boxes for the correct information.

Ensuring that the preinstallation tasks are complete

The preinstallation team completes the following tasks. If these tasks are not complete, do not continue with the installation.

- Verify that the required number of open, customer-supplied, EIA-310D (or equivalent) standard 19-in. (48-cm) 4-post equipment rack(s) is(are) properly installed and solidly secured. Ensure that the screws that come with the racks are present. If you use a rack cabinet, ensure that the cabinet has adequate ventilation.
- Verify that the rail kit to support the media server is available to install.
- Verify that the rail kit that is required to support the UPS is installed on the rack or available to install. For how to install the rails, see the documentation that comes with the rail kit.
- Verify that the equipment racks are grounded per local code. See *Job Aid: Approved Grounds* (555-245-772).
- Verify that the customer-provided AC power to the rack is from a nonswitched outlet.
- Verify that cables for the TN2312BP (IPSI) circuit packs are labeled and run from the control hardware rack to the port networks or that appropriate connectivity is provided.

S8500 hardware

The hardware components for the S8500C and 8500B versions of the S8500 Media Server are very similar but the layout of the components on the front and back panels are different. The following four diagrams show the hardware components on the front and back panels of the S8500C and S8500B with the default port assignments.

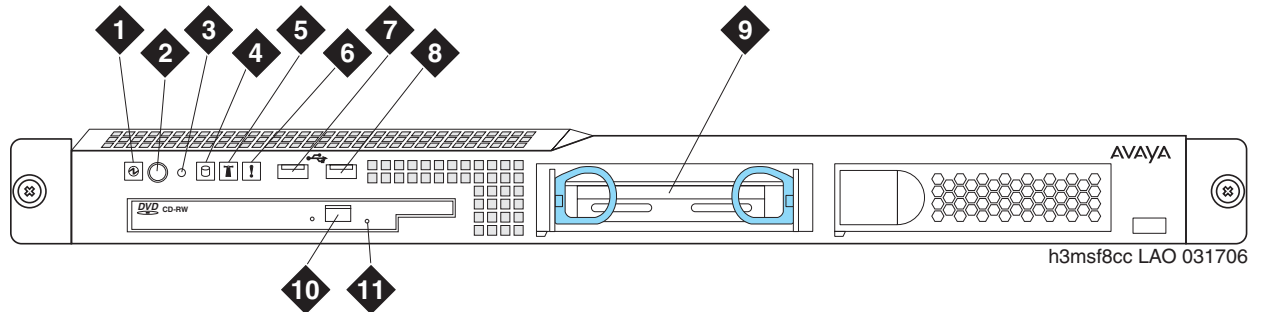
Figure 1: S8500C front panel**Figure notes:**

- | | |
|---------------------------------|-------------------------------|
| 1. Power-on LED | 7. USB port |
| 2. Power button | 8. USB port |
| 3. Reset button | 9. Hard disk drive |
| 4. Hard disk drive activity LED | 10. CD eject button |
| 5. Locator LED | 11. CD-ROM drive activity LED |
| 6. System error LED | |

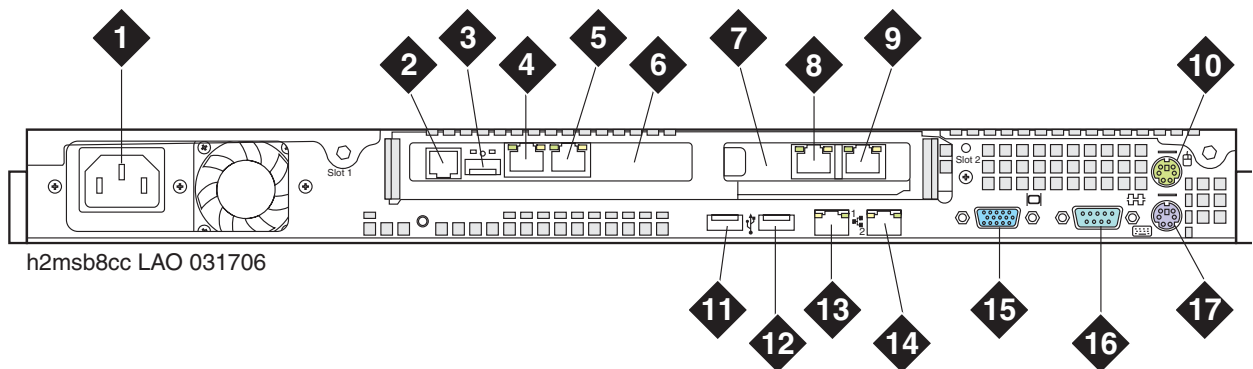
Figure 2: S8500C back panel**Figure notes:**

- | | |
|------------------------------------|------------------------|
| 1. Power cord connector | 10. Mouse connector |
| 2. SAMP power | 11. USB port |
| 3. USB connection to USB modem | 12. USB port |
| 4. Ethernet port (SAMP Eth 1) | 13. Ethernet 0 |
| 5. SAMP Services port (SAMP Eth 2) | 14. Ethernet 1 |
| 6. SAMP card | 15. Video connector |
| 7. Dual NIC | 16. Serial connector |
| 8. Ethernet 4 | 17. Keyboard connector |
| 9. Ethernet 3 | |

Figure 3: S8500B front panel

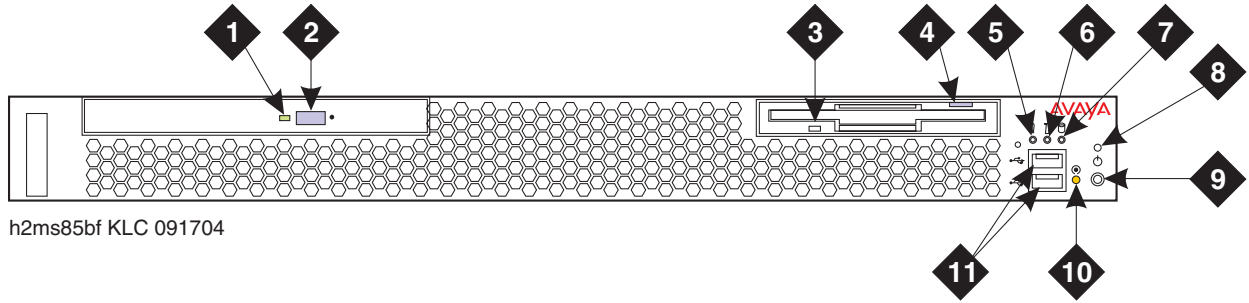

Figure notes:

- | | |
|---------------------------------|---|
| 1. CD-ROM drive activity LED | 8. Power on LED |
| 2. CD-ROM eject button | 9. Power control button |
| 3. Diskette drive activity LED | 10. Reset button — Press to reset the media server and run the power-on self-test (POST). |
| 4. Diskette eject button | 11. USB connections for the compact flash drive. |
| 5. System error LED | |
| 6. System locator LED. | |
| 7. Hard disk drive activity LED | |

Figure 4: S8500B back panel

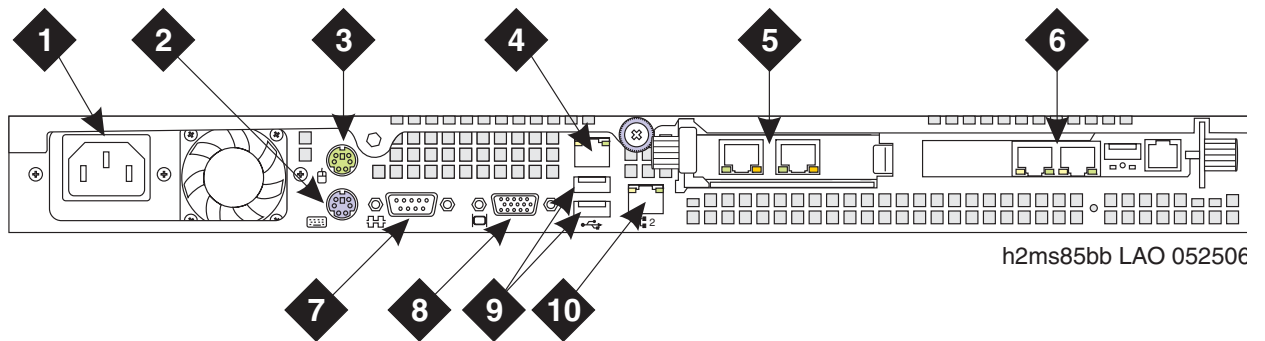

Figure notes:

- | | |
|---|---------------------------|
| 1. Power cord connector | 6. SAMP card |
| 2. Keyboard connector | 7. Video connector |
| 3. Mouse connector | 8. Serial connector |
| 4. Ethernet port (Eth 0) | 9. USB ports |
| 5. Dual NIC with Ethernet ports Eth 2 and Eth 3 | 10. Ethernet port (Eth 1) |

Equipment specifications

The S8500 Media Server control network components consist of the media server, one UPS, and an Avaya-provided Ethernet switch (optional). The physical specifications for the control network components are shown in [Table 1](#).

Table 1: S8500 control network components specifications

Component	Dimensions English (height x width x depth in inches)	Dimensions Metric (height x width x depth in centimeters)	Height (u)	Weight (lb/kg)
Media Server: S8500B S8500C	1.75 x 17 x 20 1.75 x 17 x 22	4 x 43 x 51 4 x 43 x 56	1 1	28/13
Ethernet Switch: C363T C364T	1.75 x 17 x 14.4 1.75 x 17 x 14.4	4 x 43 x 37 4 x 43 x 37	1 1	11/5 11/5
UPS: 700 VA 1500 VA	3.5 x 17 x 19 3.5 x 17 x 24	9 x 43 x 48 9 x 43 x 61	2 2	34/15 50/23

[Table 2](#) outlines the features and specifications of the Avaya S8500 Media Server. The differences between the S8500B and S8500C versions are noted.

Table 2: S8500 Media Server specifications

Feature	S8500B	S8500C
Micro-processors	CPU: 3.0 GHz Pentium (P4) FSB: 800 MHz front-side bus	CPU: 3.2 GHz Pentium (P4) FSB: 800 MHz front-side bus
Memory	One 512 MB PC2100 CL2.5 ECC DDR SDRAM RDIMM	Two 512 MB PC2-4200 CL4 ECC DDR2 SDRAM DIMM
Drives	One 80 GB SATA hard disk drive CD-ROM/DVD-ROM: IDE	One 80 GB SATA hard disk drive CD-ROM/DVD-ROM: IDE
Dual NIC	Optional	One dual NIC card
Slots	Two PCI-X slots - 64 bit/66 MHz Accommodates the SAMP and dual NIC	Two PCI-X slots - 64 bit/66 MHz Accommodates the SAMP and dual NIC
Power supply	300 W (110 VAC or 220 VAC autosensing)	350 W (110 VAC or 220 VAC autosensing)
Integrated functions	Ethernet ports: two 10/1000/100BaseT Ethernet controllers One serial port (not used) Four USB ports (3 not used) Keyboard port (not used) Mouse port (not used) Dual-channel bus mastering IDE controller	Same as the S8500B.

Environmental specifications for the S8500 Media Servers are shown in [Table 3](#).

Table 3: S8500 Media Server environmental specifications

Parameter	S8500B Specifications	S8500C Specifications
Acoustical Noise Emissions	Sound power, idling: 65 decibel maximum Sound power, operating: 65 decibel maximum	Same as S8500B Same as S8500B
Environment: Air Temperature	Media server on: 50.0°F to 95.0°F (10°C to 35°C) Altitude: 0 ft to 2999 ft (0 m to 914 m) Media server off: -40°F to 140°F (-40° to 60° C) Maximum altitude: 6998 ft (2133 m)	Same as S8500B Same as S8500B Same as S8500B Same as S8500B
Environment: Humidity	Media Server on: 8% to 80% Media Server off: 8% to 80%	Same as S8500B Same as S8500B
Heat Output	Minimum configuration: 297 BTU (87 W) Maximum configuration: 512 BTU (150 W)	Minimum configuration: 341 BTU (100 W) Maximum configuration: 1024 BTU (300 W)
Electrical Input	Receptacle U.S.: NEMA 5-15 A Circuit Breaker: 15 A Sine-wave input (47 Hz to 63 Hz) required Input voltage low range: 100 – 127 VAC Input voltage high range: 200 – 240 VAC Input kilovolt-amperes (approximate): 0.09 – 0.15 kVA Amp draw: 100 to 127 V ~ 4.6 A 200 to 240 V ~ 2.3 A	Same as S8500B Same as S8500B Same as S8500B Same as S8500B Same as S8500B Input kilovolt-amperes (approximate): 0.10 – 0.55 kVA Amp draw: 100 to 127 V ~ 6.0 A 200 to 240 V ~ 3.0A

About the Server Availability Management Processor

The Server Availability Management Processor (SAMP) remote maintenance circuit card is preinstalled in the S8500 Media Server. The SAMP monitors and reports alerts from the S8500 components to provide remote maintenance and serviceability for the media server. The SAMP also provides controls to turn on and turn off the power to the media server.

About SAMP functionality

The SAMP circuit card:

- Monitors the fans, the voltages, and the temperature.
- Reports media-server-failure alarms and other alarms to INADS by way of a modem.

Note:

Modem contention is resolved on a first-come first-serve basis. For example, Services dials into the SAMP, and the media server must send out an alarm through the modem interface. Although the modem is busy, the media server continues to try to send the alarm.

- Provides the capability to turn on power and to reset the media server remotely.
- Provides a secure dial-in connection to the SAMP and the host.
- Provides access to the SAMP and subsequently access to the host by way of the Services laptop.

The SAMP presents a virtual TTY that the media server uses when the media server must send out alarms through the modem interface (). The system uses the modem that is connected to the USB port on the SAMP card to report alarms on the:

- Media server by the media server
- Media server by the SAMP, such as server reboots.
- SAMP by the SAMP

About SAMP connections

The SAMP card is installed in PCI-X slot 1 of the Avaya S8500 Media Server. Slot 1 is a full-height, three-quarters length slot.

The SAMP comes in a half-card PCI form factor and is powered externally. The SAMP supports one USB interface and two 10/100 Ethernet ports that are located on the rear of the media server.

- SAMP Ethernet 1 is not used.
- SAMP Ethernet 2 is for local access. This port is for on-site services personnel to access the SAMP with the craft login.
- The USB interface is used to connect a USB modem for remote dial-in and dial-out access. The media server and the SAMP share this modem connection for remote maintenance, administration, and alarming. For remote dial-in, the user first establishes a Point-to-Point Protocol (PPP) session that terminates at the SAMP. The user can then use the craft login to establish an SSH (Secure Shell) or an HTTPS (Secure Web) session to the SAMP or the host.

The SAMP also communicates with the host in-band by way of an on-board industry-standard Ethernet controller on the PCI bus of the host with an internal link to the SAMP.

[Figure 5: SAMP connections for S8500B](#) shows the locations of the connections on the SAMP for the S8500B. [Figure 5: SAMP connections for S8500B](#) on page 17 shows the locations of the connections on the SAMP for the S8500C.

Figure 5: SAMP connections for S8500B

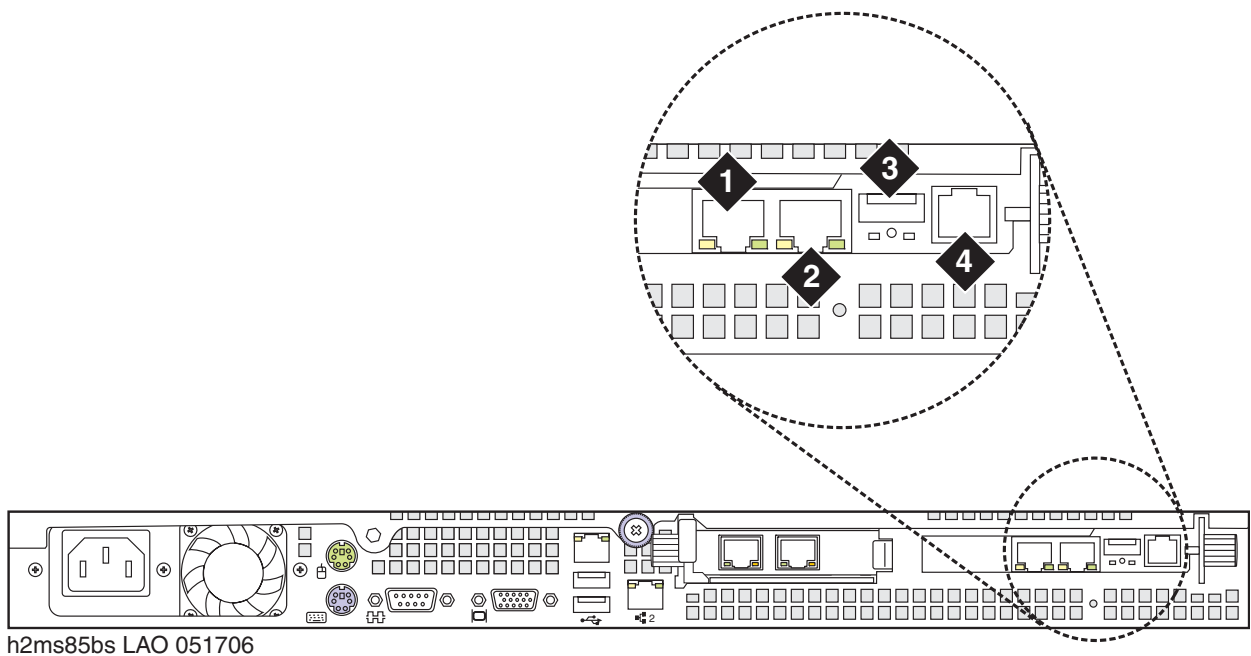

Figure notes:

1. SAMP Eth2—to the services laptop computer (cross-connect CAT5 cable)
 2. SAMP Eth1 (not used)
 3. USB connection for the modem
 4. External power to the SAMP
-

Figure 6: SAMP connections for S8500C

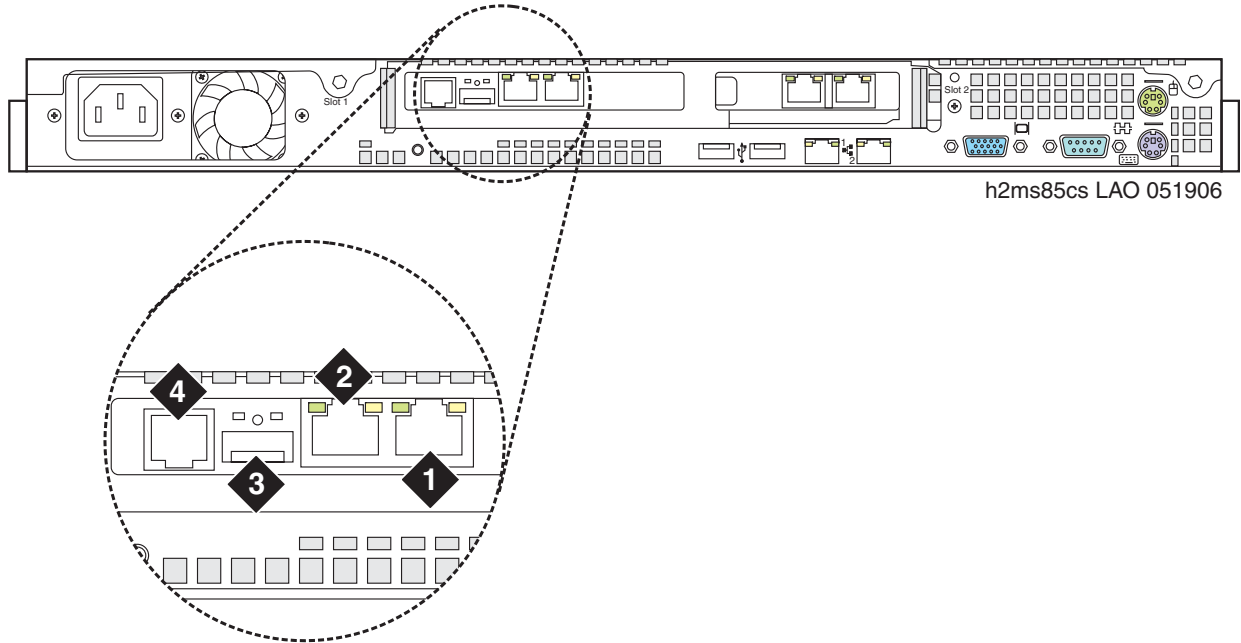

Figure notes:

1. SAMP Eth2—to the services laptop computer (cross-connect CAT5 cable)
2. SAMP Eth1 (not used)
3. USB connection for the modem
4. External power to the SAMP

About SAMP software

The SAMP is shipped from the factory with the software installed and with some default settings. However, you might need to install an updated version of the software, and you must configure the SAMP before you can use it.

If a SAMP software update file is available on the Avaya Support website, one of the preinstallation tasks required that you load the file on your laptop: see *Using the Avaya Server Availability Management Processor (SAMP)* (03-300322) for how to install software on the SAMP and change the default settings.

About media server port connections

The following section explains how to connect the Ethernet ports on the back of the media server.

S8500 port connections

Use standard CAT5 cables with RJ45 connectors on each end to connect to the various ports. If the S8500 Media Server has only one port network, connect that port network through the dual NIC. [Figure 7: S8500B Media Server connectivity guide](#) shows typical connectivity for the S8500B Media Server. [Figure 8: S8500C Media Server connectivity guide](#) on page 20 shows typical connectivity for the S8500C Media Server.

Figure 7: S8500B Media Server connectivity guide

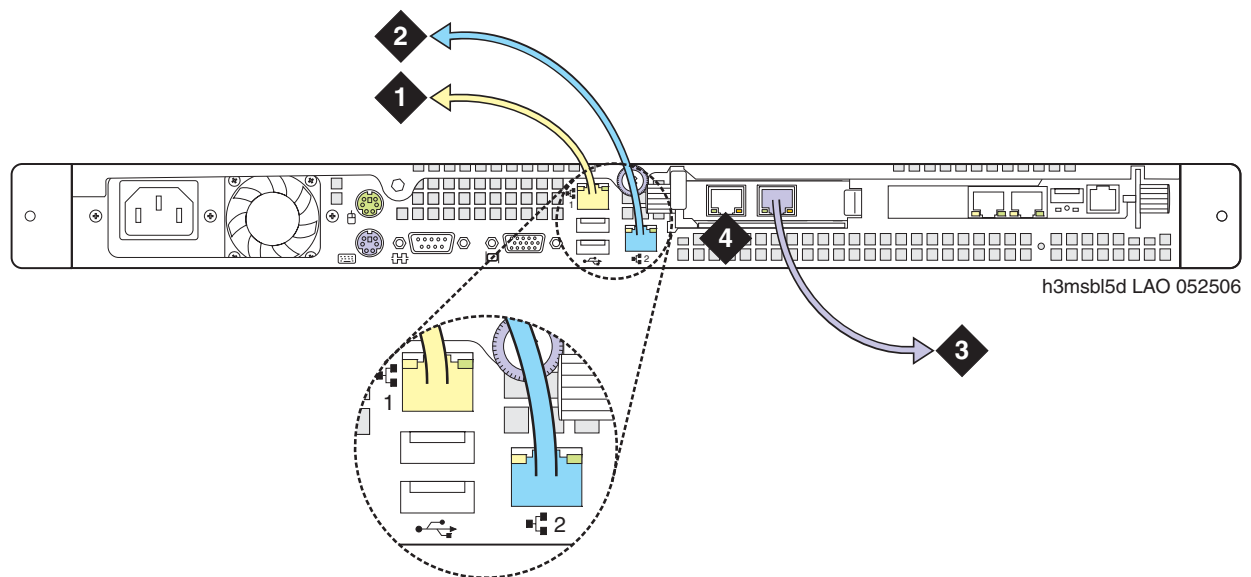

Figure notes:

- | | |
|---|---|
| <ol style="list-style-type: none"> 1. Eth0—To the customer network if the control network is shared. Or, to the control-network Ethernet switch if the control network is dedicated (straight-through CAT5 cable) 2. Eth1—To the Services laptop computer (cross-over CAT5 cable) | <ol style="list-style-type: none"> 3. Eth2—to the customer network if the control network is dedicated (straight-through CAT5 cable) 4. Eth3—Not used |
|---|---|

Figure 8: S8500C Media Server connectivity guide

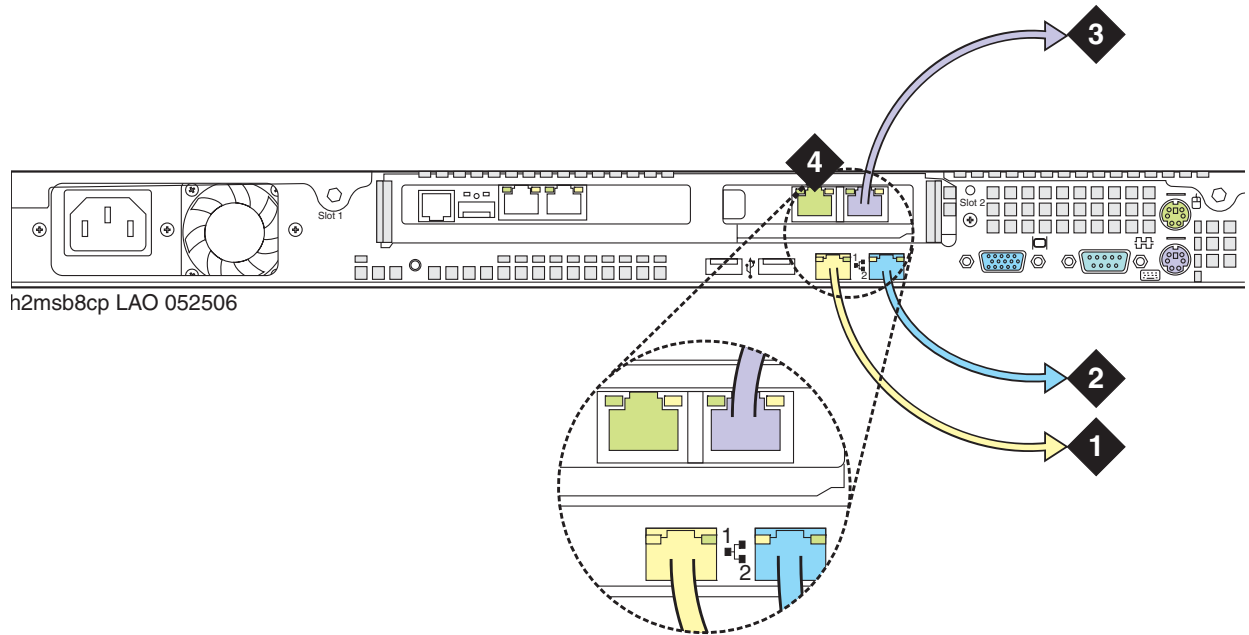

Figure notes:

1. Eth0—To the customer network if the control network is nondedicated. Or, to the control-network Ethernet switch if the control network is dedicated (straight-through CAT5 cable)
2. Eth1—To the Services laptop computer (cross-over CAT5 cable)
3. Eth3—to the customer network if the control network is dedicated (straight-through CAT5 cable)
4. Eth4—Not used

Note:

If the S8500C is configured as an ESS, the port assignments are different:

- Eth0: Control Network A
- Eth3: Control Network B
- Eth4: LAN, if two dedicated control networks are used

In either case, ETH2 is an internal port dedicated to the SAMP.

About modem connections

Note:

You cannot connect USB modems to rotary lines. A touch tone line is required.

On an Avaya S8500 Media Server, connect the modem to the USB port on the SAMP.

Avaya defaults on the SAMP set the required options on the SAMP modem. For modem connectivity, see [Figure 9: Modem connectivity on the S8500 Media Server](#).

Figure 9: Modem connectivity on the S8500 Media Server

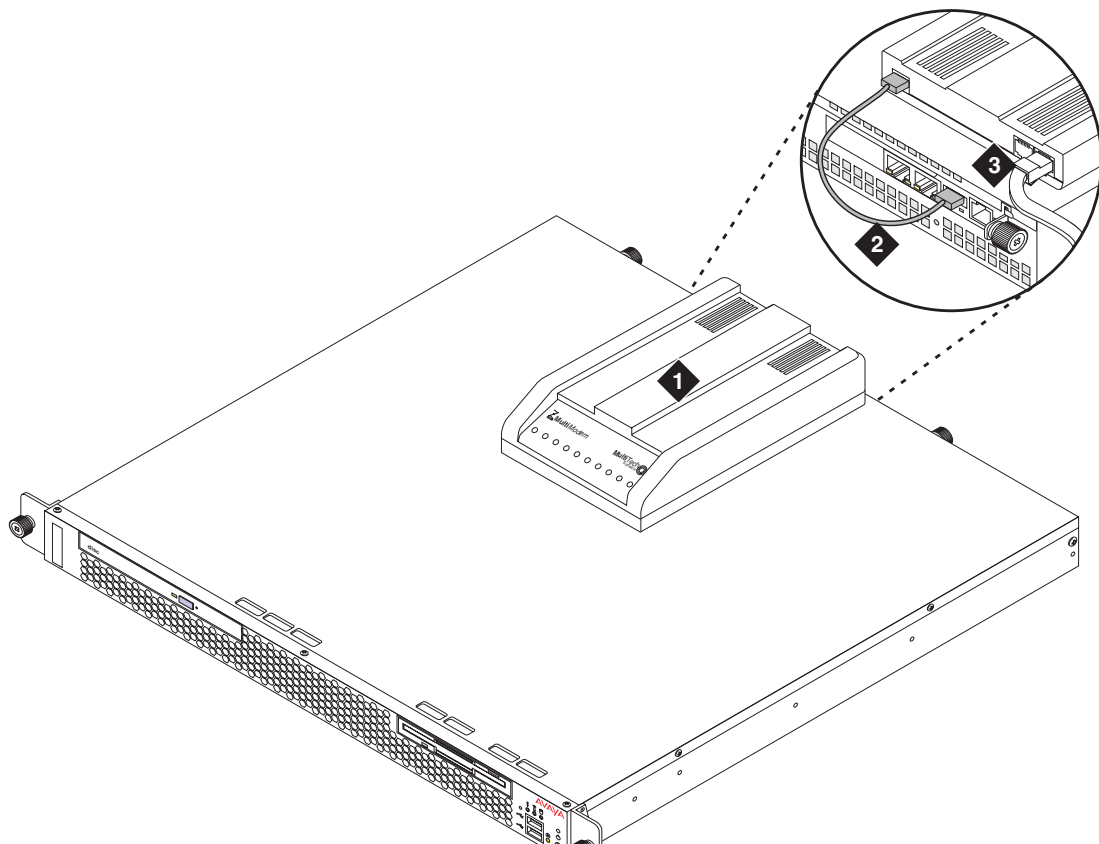
**Figure notes:**

1. Modem
2. USB cable that connects the USB modem to the USB port on the media server
3. Telephone line that connects the modem to the outside line

Modem options

You set the modem options when you configure the media server. You do not set options on the modems themselves.

About media gateways

In a new installation, the Avaya S8500 Media Server works with only the Avaya G650 Media Gateway.

In a migration, the media server works with the following Avaya media gateways:

- SCC1
- G600
- CMC1

The media servers also work with Avaya G150, G250, G350, and G700 Media Gateways. These gateways register with the media server either through the Processor Ethernet interface or through a TN799DP C-LAN circuit pack.

With an S8500 Media Server, these media gateways can be endpoints that use a Processor Ethernet interface.

Media gateways usually are installed in the same equipment room as the media server rack hardware or control network. However, you can install the media gateways in another location, including another state or country.

About Processor Ethernet

Like a C-LAN circuit pack, Processor Ethernet provides connectivity to IP endpoints, gateways, and adjuncts. The PE interface is a logical connection in the Communication Manager software that uses a port on the NIC in the server. No additional hardware is needed to implement PE.

Starting with Release 3.1 of Communication Manager, the PE interface is enabled on the S8500 Media Server to allow enhanced flexibility to connect to gateways, endpoints, and adjuncts.

[Table 4](#) lists the possible uses of the PE interface for an S8500 primary controller.

Table 4: Use of the PE interface for a simplex S8500 primary controller

Possible functions of the PE interface	Status of the function on the S8500 Media Server	Administration needed?
Registration	The PE interface is enabled for registration on a simplex main server.	No. The Communication Manager software automatically enables the use of the PE interface for registration.
H.248 gateway registration	H.248 gateway registration is allowed on the S8500 main server using the PE interface.	Yes. You perform the administration to allow H.248 registration on the PE interface of the S8500 main server on the ip-interfaces procr form.
H.323 endpoint registration	H.323 registration is allowed on the S8500 main server using the PE interface.	Yes. You perform administration to allow H.323 registration of the PE interface of the S8500 main server on the ip-interfaces procr form.
Adjunct connectivity	Adjunct connectivity is allowed on the S8500 main server using the PE interface.	Yes. To administer adjuncts, you must use the ip-services form or the communication-interface processor-channels form before the survivable-processor form.

About S8500 LSP mode

Starting with Release 3.1 of Communication Manager, you can configure the S8500 as a local survivable processor (LSP), and, the S8500 can be the primary controller for an IP network with port networks. This new functionality is enabled by allowing H.248 gateways and H.323 endpoints to use the Processor Ethernet (PE) interface of the S8500 instead of a C-LAN interface to register with the S8500.

[Table 5](#) lists the possible uses of the PE interface for an S8500 LSP.

Table 5: Use of the PE interface on the S8500 LSP

Possible functions of the PE interface	Status of the function on the LSP server	Administration needed
Registration	The PE interface is always enabled for registration.	No. The Communication Manager software automatically enables the use of the PE interface for registration.
H.248 gateway registration	H.248 gateway registration is enabled by default.	No. The H.248 gateway enabled field on the ip-interface procr form defaults to yes on an LSP. To temporarily disable H.248 registration on the LSP, you can change the ip-interfaces procr form on the LSP. Any change that you perform on the LSP is lost when the LSP receives a file sync from the main server. After a file sync H.248 gateway registration will default to yes .
H.323 endpoint registration	H.323 endpoint registration is enabled by default.	No. The H.248 gateway enabled field on the ip-interface procr form defaults to yes on an LSP. To temporarily disable H.248 registration on the LSP, you can change the ip-interfaces procr form on the LSP. Any change that you perform on the LSP is lost when the LSP receives a file sync from the main server. After a file sync, H.248 gateway registration defaults to yes .
Adjunct connectivity	Adjunct connectivity is enabled by default.	Yes. You must perform adjunct administration for the LSP on the main server.

The PE interface on an S8500 LSP supports three adjuncts:

- Call Management System (CMS)
- Application Enablement Services (AESVCS)
- Call Detail Recording (CDR)

The S8500 as a primary controller can connect to gateways and endpoints that use both C-LANs and the PE interface. The traffic over these interfaces can be load balanced.

S8500 LSP license file

The license file for an LSP must have the following attributes:

- The Local Survivable Processor (FEAT_LSP) field is set to **y**.
- A Module ID (MID) that is greater than 1. This value is set by the license file and cannot be administered in Communication Manager.
- A System ID (SID). The SID is unique to the system configuration. The primary controller and all LSPs have the same SID.
- The serial number of an H.248 media gateway to serve as the license serial number host.

During initial installation, when the LSP server is reset, the LSP sends this serial number to the primary controller. The primary controller then matches the serial number to the serial number of an existing media gateway. The primary controller sends the IP address of the media gateway back to the LSP. To verify the license, the LSP can then contact that media gateway and request the serial number. The LSP compares the serial number from the media gateway with the serial number from the license of the LSP.

About SSH

Secure Shell (SSH) is both a computer program and an associated network protocol that you use to log in to and run commands on a networked computer. SSH provides secure encrypted communications between two untrusted hosts over an insecure network. Avaya strongly recommends that you use SSH instead of Telnet for most interactive connections to the Avaya media servers and other devices on a customer network.

To use SSH, a third-party SSH client must be installed on your computer. PuTTY is one such client. You can download PuTTY from <http://www.putty.nl/download.html>.

Chapter 1: Introduction

You can use SSH to access the following devices:

- The S8300, S8400, S8500, and S8700-series Media Servers on Release 3.1 or later of Communication Manager

Note:

With Release 4.0 or later of Communication Manager, Telnet is disabled, so you must use SSH to access the media servers after Communication Manager software Release 4.0 or later is installed.

- A Server Availability Management Processor (SAMP), which is used with the S8500 Media Server
- A Maintenance Processor Complex (MPC), which is used with the S8400 Media Server
- A TN2312BP IPSI that is running firmware version 20 or higher
- A TN8412AP SIPI
- A TN2602 IP Media Resource 360 that is running firmware version 212 or higher
- An Expanded Meet-Me Conferencing (EMMC) server
- A SIP Enablement Services (SES) server
- G250 and G350 media gateways
- C360 Ethernet switches



Important:

You cannot use SSH with the G700. From within the Linux command line of a media server, you can use SSH to access the G250 and the G350, but you must use Telnet to access the G700.

Chapter 2: SNMP Configuration

After you install and connect the control network equipment, you must configure the SNMP modules in each Avaya-supplied UPS to send alarms or traps to the media servers. This process requires that you also configure the SNMP subagent in the Avaya-supplied Ethernet switch.

**Important:**

Use the procedures in this section to configure Avaya-supplied equipment only.

Configuring the SNMP modules in the UPS

**Important:**

These procedures apply only to a new, Avaya-supplied uninterruptible power supply (UPS) with a Simple Network Management Protocol (SNMP) module. Do not use these procedures to set traps on a UPS that Avaya does not supply.

You must configure the SNMP module in the UPS to report alarms to the media server when hardware problems occur. The module reports an alarm if commercial power is lost or battery resources are depleted.

For the SNMP module to properly report alarms, you must configure a unique IP address for the UPS on both the SNMP module and the media server. This IP address can be a customer-provided address or the Avaya-provided default address. At a minimum, you must configure the following items:

- The IP address
- The subnet mask
- The gateway IP address
- The trap receiver IP address
- The community string (get, set, trap)

A third party manufactures the SNMP module. The brand, the model, or the firmware load of the module that Avaya supplies can change without notice. For this reason, this document does not provide specific instructions on how to connect to and configure the SNMP module. For more information, see the documentation that comes with the SNMP module. For the default password and the configuration commands, see the local configuration section of that user guide.

Default IP addresses for the UPS

The following table shows the default IP addresses for the UPS.

IP address for the UPS	198.152.254.239
Subnet mask for the UPS	255.255.255.0
Gateway address for the UPS	198.152.254.201
IP address for the trap receiver (media server)	Customer provided

For how to administer the SNMP module in the UPS, see [Administering the SNMP module](#) on page 29.

Prerequisites for configuring the SNMP module

Before you configure the SNMP module, you must complete the following prerequisites:

- Your Services laptop computer is plugged into the correct administration port on the SNMP module.
- The UPS is plugged into a nonswitched electrical outlet.
- The communication protocol on your computer has the following port settings so that you can use your terminal emulation program:
 - 9600 baud
 - No parity
 - 8 data bits
 - 1 stop bit
 - No flow control

Note:

Avaya Terminal Emulation and HyperTerminal are supported terminal emulation applications.

- If a Network Management System (NMS) is to monitor the UPS, you coordinated the assignment of community names with the network administrator. If an NMS is not used, you set the community names to unique string values.

 SECURITY ALERT:

The Get and Set community name strings are initially configured with the default values of Public and Private, respectively. These community name strings function as passwords for their respective SNMP operation. Avaya recommends that you change these community name strings to something other than the default values. If you leave the defaults in place, a serious security issue can result.

For information about which traps to set, see [Setting selected traps \(alarming\)](#) on page 30.

- If the control network is nondedicated, ensure that the 162/udp port for input to server is enabled and the default is disabled. If you do not enable the 162/udp port and disable the default, the media server cannot receive the traps from either UPS. See [Enabling firewall settings](#) on page 44.

Administering the SNMP module

Note:

Use the default IP addresses.

1. Connect the RS-232 serial port of your Services laptop computer to the DB-9 connector on the back of the SNMP module for UPS1. Use the DB-9 to DB-9 serial cable that is supplied with the SNMP module.
2. Open a VT-100 terminal emulation session on your computer.
3. Set the IP address for the UPS.
4. Set the subnet mask for the UPS.
5. Set the gateway address for the UPS.
6. Set the IP address of the trap receiver for the UPS.
7. Set the SNMP community name string for Get, Set, and Trap. For information on which traps to set, see [Setting selected traps \(alarming\)](#) on page 30.
8. When you finish, disconnect your computer from the UPS.
9. Connect one end of a CAT5 straight-through cable to the RJ45 connector on the UPS SNMP module and the other end of the cable to the next available port on the Ethernet switch for Control Network A (CNA).

For a connectivity guide, see the *Quick Start for Hardware Installation: Avaya S8500 Media Server* (555-245-701).

After you configure the SNMP module in the UPS, you must configure the SNMP subagent on the Avaya Ethernet switch.

Setting selected traps (alarming)

The default is to set all traps, which can result in large log entries. To avoid this problem, Avaya recommends that you set only the following traps:

- UPS on Battery—Indicates an AC power failure. Based on the level of battery reserve, a shutdown is pending.
- UPS in Bypass—The UPS failed or is overloaded.
- Replace battery—The battery failed the 28-day battery test and must be replaced.

For the menus and commands to set these traps, see the user guide that comes with the SNMP module.

Configuring the SNMP subagent in the Avaya Ethernet switch (if used)



Important:

These procedures apply only to a new, Avaya-supplied uninterruptible power supply (UPS) with a Simple Network Management Protocol (SNMP) module. Do not use these procedures to set traps on a UPS that Avaya does not supply.

You must administer the Simple Network Management Protocol (SNMP) subagent in the Avaya Ethernet switch to report alarms to the media server when problems occur.

For the SNMP module to properly report alarms, you must configure a unique IP address for the UPS on both the SNMP module and the media server. This IP address can be a customer-provided address or the Avaya-provided default address. At a minimum, you must configure the following items:

- The IP address
- The subnet mask
- The gateway IP address
- The trap receiver IP address
- The community string (get, set, trap)

The brand, the model, or the firmware load of the Ethernet switch that Avaya supplies can change without notice. For this reason, this document does not provide specific instructions on how to connect to and configure the SNMP subagent. For more information, see the documentation that comes with the Ethernet switch. Also see the Basic Configuration section of the Quick Start Guide and the documentation CD-ROM that comes with the Ethernet switch for the default user ID, password, and configuration commands.

Note:

For the Ethernet switch to report alarms properly, you must also configure the IP addresses for the Ethernet switches in the media servers.

Default IP addresses for the Ethernet switch

The following table shows the default values for the Ethernet switch.

Parameter	Single control network (CNA)	Duplicated control network (CNB)
IP address for the Ethernet switch	198.152.254.240	198.152.255.240
Subnet mask for the Ethernet switch	255.255.255.0	255.255.255.0
IP address for the trap receiver (media server)	Customer provided	Customer provided

For how to administer the SNMP subagent in the Ethernet switch, see [Configuring the Ethernet switch](#) on page 32.

Preparing to configure the Ethernet switch

Before you configure the Ethernet switch, you must complete the following prerequisites:

- The Ethernet switch power cord is connected to the back of the switch and to the back of a UPS.
- The communication protocol on your computer has the following port settings so that you can use your terminal emulation program:
 - 9600 baud
 - No parity
 - 8 data bits
 - 1 stop bit
 - No flow control

Note:

Avaya Terminal Emulation and HyperTerminal are supported terminal emulation applications.

- If a Network Management System (NMS) is to monitor the Ethernet switch, you coordinated the assignment of community names with the network administrator. If an NMS is not used, you set the community names to unique string values.

SECURITY ALERT:

The Get and Set community name strings are initially configured with the default values of Public and Private, respectively. These community name strings function as passwords for their respective SNMP operation. Avaya recommends that you change these community name strings to something other than the default values. If you leave the defaults in place, a serious security issue can result.

- If the control network is not dedicated, ensure that the 162/udp port for input to server is enabled and the default is disabled. If you do not enable the 162/udp port and disable the default, the media server cannot receive the traps from either UPS. See [Enabling firewall settings](#) on page 44.

Configuring the Ethernet switch

Note:

Use the default addresses.

1. Connect the RS-232 serial port of your Services laptop computer to the port labeled Console on the front of Ethernet switch 1 (CNA). Use the flat cable supplied with the Avaya Ethernet switch.
2. Open a VT-100 terminal emulation session on your computer.
3. Set the IP address for the Ethernet switch.
4. Set the subnet mask for the Ethernet switch.
5. Set the gateway IP address for the Ethernet switch.
6. Set the IP address of the trap receiver for the Ethernet switch.
7. Set the SNMP community name string for Get, Set, and Trap. For information about setting these values, see the section on SNMP commands on the documentation CD-ROM that comes with the Avaya Ethernet switch.
8. Use the command `set spantree enabled` to verify that spanning tree is enabled. Note that *enabled* is the default setting.
9. Use the command `set spantree version rapid-spanning-tree` to set the spanning tree version to *rapid-spanning-tree*. Do not use the default.

Note:

This command is available on Avaya Ethernet switches with firmware version 4.0 or later. To use this command, you must update the firmware to this version, if necessary.

For more information on the spanning tree CLI commands, see *Installation and Configuration Guide, Avaya C360* and *Reference Guide, Avaya C360*. These documents are available at the Avaya Support Web site <http://www.avaya.tha.com/support>.

Configuring the SNMP subagent in the Avaya Ethernet switch (if used)

10. If the port networks are IP-PNC, ensure that all appropriate ports on the Ethernet switch are locked to 100 speed and full duplex.
11. When you finish, disconnect your computer from the Ethernet switch.
12. If two Ethernet switches are present for CNA, repeat Steps 1 through 10 for the second switch.

Chapter 3: Communication Manager installation

A new media server comes with a blank hard disk drive. Use the bootable software distribution CD-ROM to install the Linux operating system and Avaya Communication Manager.

This chapter covers the following tasks:

- [Clearing the ARP cache on the laptop](#) on page 35
- [Applying power to the media server](#) on page 36
- [Accessing the media server](#) on page 36
- [Configuring Telnet for Windows 2000 and Windows XP](#) on page 36
- [Installing Avaya Communication Manager](#) on page 37



Important:

If you are installing an S8500B Media Server to run the Expanded Meet-me Conferencing (EMMC) application, follow the installation instructions in this document up to and including . Then use the *Expanded Meet-me Conferencing (EMMC) version 1.0 Installation and Troubleshooting Guide, (04-300527)* to complete the installation of the EMMC. The two CD-ROMs *EMMC Software Disk 1* and *EMMC Software Disk 2* contain the EMMC software.

Clearing the ARP cache on the laptop

Depending on the operating system of your Services laptop computer, you might need to clear the Address Resolution Protocol (ARP) cache before you enter a new IP address. If you enter an IP address and your computer cannot connect, perform the following procedure to clear the cache.

1. On your computer, click **Start** > **Run** to open the Run dialog box.
2. Type `command` and press **Enter** to open an MS-DOS command line window.
3. Type `arp -d 192.11.13.6` and press **Enter** to clear the ARP cache in the laptop.

If the ARP cache does not contain the specified IP address, the message **The specified entry was not found** appears. You can ignore this message.

4. Type `exit` and press **Enter** to close the command line window.

Applying power to the media server

Note:

In this procedure, the software CD-ROM must be placed into the CD-ROM drive on the media server immediately after you turn on the power to the media server.

1. Connect the AC power cord to the media server and to the UPS or a nonswitched electrical outlet.
2. If the media server does not turn on, press the white power control button on the front of the media server.
3. Immediately place the Avaya Communication Manager CD-ROM into the CD-ROM drive on the media server. Or, If you are installing an S8500 Media Server to run the Expanded Meet-me Conferencing (EMMC) application, use the CD-ROM that is labeled *EMMC Software Disk 1*.

Accessing the media server

1. Use a cross-over cable to connect your laptop computer to the Services port on the back of the media server. The Services port is labeled "2" and is configured as Eth1.
2. Wait at least 3 minutes after you turn on the media server before you start a Telnet session to access the information on the CD-ROM.

Configuring Telnet for Windows 2000 and Windows XP

The Microsoft Telnet application might be set to send a carriage return (CR) and a line feed (LF) whenever you press **Enter**. The Communication Manager installation program sees this as two key presses. If you are running Windows 2000 or Windows XP, you must correct this setting before you copy the Remaster Program to the hard disk drive.

1. Click **Start > Run** to open the Run dialog box.
2. Type `telnet` and press **Enter** to open a Microsoft Telnet session.
3. Type `unset crlf` and press **Enter**.
4. Type `display` and press **Enter** to verify that you see the message **Line feed mode - Causes return key to send CR**.
5. Type `q` and press **Enter** to exit the telnet session.

Installing Avaya Communication Manager

Use a Telnet session to access the information on the CD-ROM.

1. On your Services laptop computer, click **Start** > **Run** to open the Run dialog box.
2. Type `telnet 192.11.13.6` and press **Enter** to view the first screen.

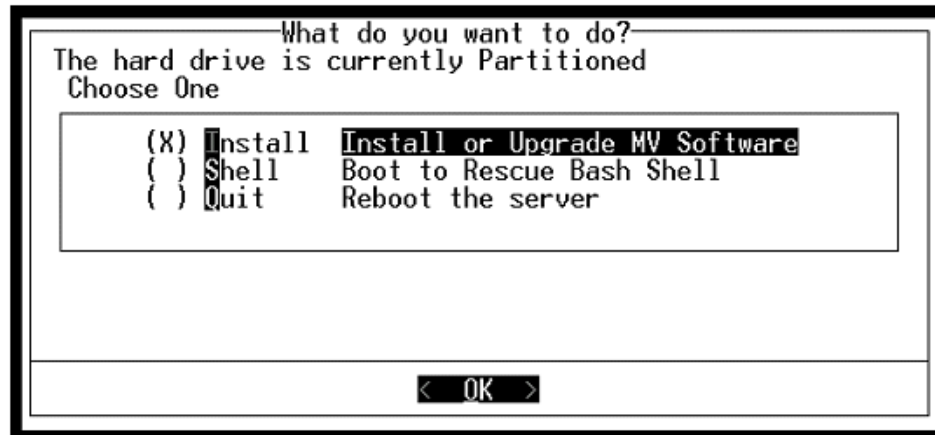

Note:

To navigate on these screens, use the arrow keys to move to an option, and then press the spacebar to select the option. Press **Enter** to submit the information on the screen.

3. Select **Install**, ensure that **<OK>** is highlighted, and press **Enter**.
4. On the Select Release Version screen, ensure that the Build line and **<OK>** are highlighted. Press **Enter** to partition the hard disk drive and reformat the partitions.

Once the drive is properly configured, the program starts the installation process and reports the progress.

These processes can take up to 20 minutes to complete.
5. You must remove the CD-ROM from the drive at this time. When the media server is ready to reboot, the drawer of the CD-ROM drive opens.

The reboot can take up to 3 minutes. The Telnet session drops automatically when the reboot starts.
6. Perform one of the following actions:
 - If you are installing the S8500 Media Server as a call controller, continue with the next section of this document.
 - If you are installing the S8500 as an LSP, continue with [Chapter 7: Install an S8500 Media Server as an LSP](#) on page 63.

Chapter 3: Communication Manager installation

- If you are installing an S8500 Media Server to run the Expanded Meet-me Conferencing (EMMC) application, you are finished with this document. Continue the EMMC installation procedures described in *Installing and Troubleshooting the Expanded Meet-me Conferencing (EMMC)* (04-300527).

Chapter 4: Media server configuration

After you install the Communication Manager software, you must use the Avaya Installation Wizard to configure the media server.

This section covers the following tasks:

- [Copying files to the media server](#) on page 40
- [Creating a super-user login](#) on page 40
- [Running the Avaya Installation Wizard](#) on page 42
- [Verifying the RMB IP information](#) on page 42
- [Installing SAMP firmware](#) on page 42
- [Verifying the media server connection to the customer LAN \(if provided\)](#) on page 43
- [Enabling firewall settings](#) on page 44
- [Enabling network time servers](#) on page 44
- [Checking LED activity on the dual NIC](#) on page 46
- [Configuring the NIC](#) on page 46

Note:

Ensure that you have the completed *Electronic Preinstallation Worksheet* (EPW) before you start this process.

Note:

Ensure that your networking and Web browser settings are correct. For more information, see [Configuring the network for Windows 2000 and XP](#) on page 94.

Opening the Maintenance Web Interface

You can use the Maintenance Web Interface to copy license files and authentication files, service packs, and SAMP update files from the Services laptop to the media server. For how to open the Maintenance Web Interface, see [Accessing the Maintenance Web Interface](#) on page 92.

Copying files to the media server

1. From the Maintenance Web Interface, under **Miscellaneous**, click **Download Files**.
2. Select **File(s) to download from the machine I'm using to connect to the server**.
3. Click **Browse** next to the top field to open the Choose File window on your computer. Find the files that you need to copy to the media server.
4. Click **Download** to copy the files to the media server.

The files are automatically copied to the default file location.

Creating a super-user login

Note:

A craft level login can create the super-user login in Release 4.0 or later.

Make sure you have a login name and password that the customer would like for the superuser login. If you are a business partner, you can also repeat this procedure to add the dadmin login.

To create a login:

Note:

Make sure the customer can change this login, its password, or its permissions later.

1. Under **Security**, select **Administrator Accounts**.
2. Type the login name in the **Enter Login ID or Group Name** field.
3. Select **Add Login**, and click **Submit**.
4. Type **susers** in the **login group** field.
5. Type **prof18** in the **additional groups** field. *prof18* is the code for the customer superuser.

6. Put a check in the **allow Linux shell access** field.
7. Skip the **lock this account** and **date on which account is disabled** fields.
8. For the **select type of authentication** option, select **password**.
9. Complete the following fields:
 - enter key or password
 - re-enter key or password
 - force password/key change on first login

Note:

Do not lock the account or set the password to be disabled.

10. Leave the defaults in the remaining fields.
11. Click **Add**.

The system tells the login is added successfully.

About the Avaya Installation Wizard

Use the Avaya Installation Wizard to automatically:

- Configure the media server
- Configure the Remote Maintenance Board
- Install the license file

Note:

To install the license file the server does not have to be connected to the reference IPSI. However, you have only 30 minutes before the system checks the serial number on the IPSI. To add another 30 minutes, type `reset system 1` and press **Enter** in a SAT session to restart the Communication Manager software.

- Install the Avaya authentication files
- Install software updates

To use the Installation Wizard, you can either:

- Import the data from the completed *Electronic Preinstallation Worksheet* (EPW). When the Installation Wizard prompts you to import the Preinstallation Worksheet, click **Import EPW** and browse to the location of the EPW file on your Services laptop computer. The Installation Wizard opens the EPW and uploads the configuration data.
- Type the information manually with the completed EPW as a guide. The Installation Wizard prompts you to enter the configuration data for each step in the Configure Server section.

Running the Avaya Installation Wizard

1. With the Web browser open, type `192.11.13.6` and press **Enter** in the browser address window to display the login page.
2. Log in as `craft` and use the initial craft password.
3. Click **Launch Avaya Installation Wizard**.
4. Follow the prompts. For more information use **Help** on each page.

Verifying the RMB IP information

The Remote Maintenance Board (RMB) page is under **Optional Services** in the Installation Wizard configuration process. Verify that the Installation Wizard retrieved the IP information from the EPW. If the information is not there, complete all fields manually.

To allow Services access to the remote maintenance board through a cross-over cable, verify the information in the following fields:

- **IP Address 192.11.13.6**
- **Subnet Mask 255.255.255.252**

If the information is not there, complete the fields manually.

Installing SAMP firmware

You might need to update the SAMP firmware if the most current version is not installed. Information about the versions that require updates should be included in your project planning information.

For how to update SAMP software, see *Using the Avaya Server Availability Management Processor (SAMP)*.

1. Check the firmware version:
 - a. Use SSH to access the media server and log in.
 - b. Type `sampcmd samp-update status` and press **Enter**.
 - c. Check the firmware version displayed.
2. If you need to update the firmware, from the Maintenance Web Interface under Miscellaneous, click **Download Files**.

3. Enter the information to copy the firmware file to the media server.
4. Use SSH to access the media server and log in.
5. To start the update process, type `sampupdate` and press Enter.
The update process takes approximately 5 minutes.

Verifying the media server connection to the customer LAN (if provided)

1. From the Maintenance Web Interface, under Diagnostics, click **Ping**.
2. Select **Host Name Or IP Address** and type the IP address of a computer on the network.
3. Click **Execute Ping**.
4. Verify that the ping was successful and indicates that the media server is connected to the customer network.
5. If DNS is administered, type the host name of a computer on the network.
6. Click **Execute Ping**.
7. Verify that the ping was successful and indicates that DNS is working.

If possible, have a customer representative perform the following test from a computer on the network:

1. Click **Start > Run** to open the Run dialog box.
2. Type `command` and click **OK** to open an MS-DOS command window.
3. Type `ping serveripaddress` and press **Enter**, where `serveripaddress` is the IP address of the media server.
4. Verify that the ping was successful.
5. If DNS is administered, type `ping servername` and press **Enter**, where `servername` is the host name of the media server.
6. Verify that the ping was successful.

Configuring the modem

1. From the Maintenance Web Interface, under Server Configuration click **Configure Server**.
2. Click **Continue** until you get to the **Specify how you want to use this wizard** page.

3. Select **Configure individual services** and click **Continue**.
4. On the menu on the left, click **Set Modem Interface**.
5. Select **Change Modem Setting** and click **Continue**.
6. In the Extra Modem Initialization Commands window, type the initialization commands that are appropriate for your modem and the country of operation. Click **Help** for help on what to enter.

For example, to change the country code to Japan, type `AT%T19,0,10`.

7. Click **Change**.

The system displays a message that indicates that a modem route was added successfully.

8. Click **Close Window**.

Enabling firewall settings

For the media server to receive SNMP traps from the UPS and the Avaya Ethernet switch, you must enable the snmptrap,162/udp port. The default is disabled.

1. From the Maintenance Web Interface, under Security, click **Firewall**.
2. Scroll down to the snmptrap 162/udp row and select (check) the **Input to Server** box.
The **Output to Server** box can be left as is, either checked or clear.
3. Click **Submit**.

Enabling network time servers

 **Important:**

Avaya strongly recommends that you enable Network Time Protocol (NTP) and configure at least one network time server. If a network time server is not used the Date/Time settings on the media server must be reset regularly, at least monthly, using the Maintenance Web Interface. The network time strategy is determined by the network administrator.

With NTP, you can specify one, two, or three network time servers to provide the accurate time of day data to the clocks on the media servers. The network time servers, in turn, get their source timing from one of several highly accurate time services that are available on the Internet.

To use a network time server, the NTP service must be enabled. The Avaya Installation Wizard prompts you to enable the NTP service. If you do not use the Installation Wizard, use the Configure Server function on the Maintenance Web Interface to configure the network time servers.

1. From the Maintenance Web Interface, under Server Configuration, click **Configure Server**.
2. Click **Continue** on the Review Notices page and the Backup Up Data page.
3. On the "Specify how you want to use this wizard" page, select **Configure individual services** and then click **Continue**.
4. In the menu on the left side of the Configure Server page, click **Configure Timer Server**.
5. Enter the NTS information on the Configure Time Server screen and click **Change**.
6. On the main menu, under Security, click **Firewall**.
7. In the "Output from Server" column, select **ntp 123/udp**.

Note:

It is not necessary to enable the "Input to Server" ntp service. If this service is already enabled, you do not need to disable it.

When the Avaya Installation Wizard prompts you for information about the network time servers, enter the DNS name or the IP address for the primary network time server and the secondary and the tertiary time servers if any. If you enter a DNS name instead of an IP address for the network time server, you must specify the IP address of the DNS server. For more information, see [About the Avaya Installation Wizard](#) on page 41.

For more information about NTP, see RFC 958.

Checking LED activity on the dual NIC

When the S8500 Media Server is in service, check the LEDs on each port of the dual network interface card (NIC) for connection and activity. Ensure that the LED on the left that indicates connection is lit and the LED on the right that indicates activity is lit or blinking. For dual-NIC LED information, see [Figure 10: S8500B rear panel dual-NIC LEDs](#) on page 46.

Note:

The dual NIC is optional with the S8500B but ships installed with the S8500C. The dual NIC is located on the rear panel in different positions on the S8500B and S8500C but the port LEDs are the same. See [Figure 2: S8500C back panel](#) on page 11 for a diagram of the S8500C back panel.

Figure 10: S8500B rear panel dual-NIC LEDs

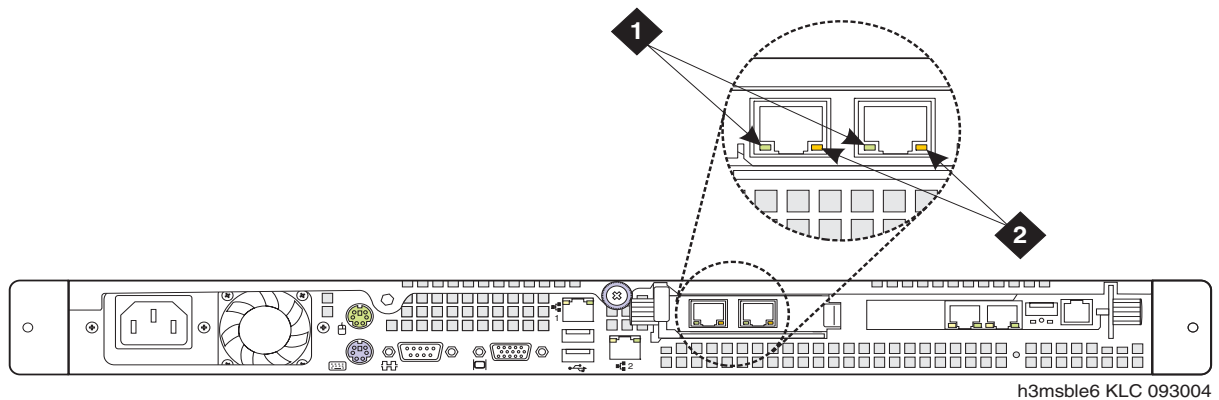

Figure notes:

1. Network activity LED (TX/RX)
2. Connection rate:
 - Off: a 10BaseT active link
 - Green: a 100BaseT active link
 - Orange: a 1000BaseT active link

Configuring the NIC

1. From the Maintenance Web Interface, under Server Configuration, click **Configure Server**.

2. Click **Continue** until you get to the "Specify how you want to use this Wizard" page.

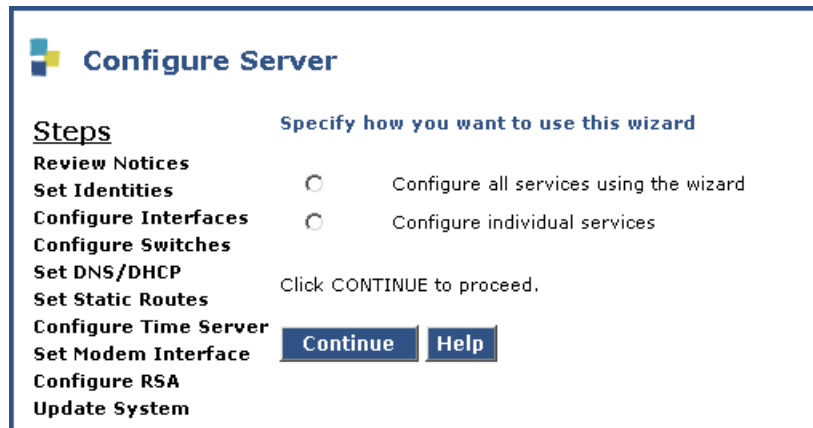

3. Select **Configure Individual Services** and click **Continue**.
4. On the menu on the left, click **Set Identities**
5. Use the drop-down menus to assign the Ethernet port functions. The following table shows the default assignments for three S8500 configurations:

Table 6: Recommended port assignments for S8500B and S8500C¹

Functionality	S8500B with dual NIC	S8500B without dual NIC	S8500C
Control Network A	Ethernet 0	Ethernet 0	Ethernet 0
Services laptop computer	Ethernet 1	Ethernet 1	Ethernet 1
Internal SAMP	Ethernet 4	Ethernet 2	Ethernet 2
Control Network B — ESS for S87xx system with duplicated control	Ethernet 2	Unused	Ethernet 3
Corporate LAN — Private control network	Ethernet 3	NA	Ethernet 4
Corporate LAN — Shared control network	Ethernet 0	Ethernet 0	Ethernet 0

1. These port assignments are recommended when using the Set Identities web page in the Maintenance Web Interface. The settings entered on this web page might not correspond to the setting reported for the CLI `ifconfig` command.

6. Click **Continue**.
7. Complete the following information for Ethernet 2:
 - IP address
 - Gateway
 - Subnet mask
 - Speed
8. Verify with the network administrator that the LAN hardware supports 802.1q priority tagging. If supported, select **VLAN 802.1q priority tagging**.
9. Click **Change**. The system displays the status of the configuration update.
When the update is complete, the system displays the following message:
Successfully configured ethernet interfaces.

Disconnecting from the media server

Unplug the cross-over cable from the Services port on the back of the media server.

Chapter 5: IP interface translations

To administer IPSI circuit packs, use a terminal emulation program to issue Communication Manager SAT commands.

For Communication Manager terminal emulation, use a program such as Avaya Native Configuration Manager, Avaya Terminal Emulation, or HyperTerminal.

You also can use Avaya Site Administration to issue SAT commands. To administer some of the features in the latest release of Avaya Communication Manager, you must use the latest version of Avaya Site Administration.

Perform these tasks to administer IPSI circuit packs:

- [Inputting initial system translations](#) on page 49
- [Adding media gateways](#) on page 50
- [Enabling the IPSI](#) on page 51
- [Adding the IPSI to the system](#) on page 52
- [Setting the alarm activation level](#) on page 52
- [Saving translations](#) on page 52

Inputting initial system translations

1. Open a SAT session. See [Using the SAT command line prompt](#) on page 93.
2. Enter translations:

If the system translations were prepared offsite, enter the translations and reset the media server.

If the translations are not available, enter minimal translations to verify connectivity to the port networks.
3. After you enter the translations, type `save translation` and press **Enter** to save the translations to the hard disk drive.
4. Type `reset system 4` and press **Enter** to have the software read the copied translations.

Adding media gateways

Note:

If system translations have been loaded on the media server, media gateways do not need to be added to administer the IPSI.

1. Type `add cabinet n` and press **Enter**, where `n` is the cabinet number, for each stack of media gateways that is controlled by one TN2312BP IPSI circuit pack.

A cabinet is defined as a group of up to five G650 Media Gateways that are mounted in a rack and TDM-connected.

2. Fill in the carrier location letter and the carrier type for each media gateway in the cabinet.

```

add cabinet 1
                                                    Page 1 of 1
                                CABINET
CABINET DESCRIPTION
    Cabinet: 1
    Cabinet Layout: G650-rack-mount-stack
    Cabinet Type: expansion-portnetwork
Number of Portnetworks: 1
Survivable Remote EPN? n
    Location: 1                IP Network Region:1
    Cabinet Holdover: A-carrier-only
    Room:                    Floor:                Building:

CARRIER DESCRIPTION
Carrier      Carrier Type      Number
E           not-used         PN 09
D           not-used         PN 09
C           not-used         PN 09
B           G650-port      PN 09
A           G650-port      PN 09
    
```

Enabling the IPSI

1. Type `change system-parameters ipserver-interface` and press **Enter**.
2. On the IP Server Interface System Parameters screen, verify that the primary control subnetwork address is correct.

```

change system-parameters ipserver-interface                               Page 1 of 1
                                IP SERVER INTERFACE (IPSI) SYSTEM PARAMETERS

SERVER INFORMATION

                                IPSI Host Name Prefix:
                                Primary Control Subnet Address: 172. 22. 0. 0*
                                Secondary Control Subnet Address: 192. 11 . 13 .4*

OPTIONS

                                Switch Identifier: A
                                IPSI Control of Port Networks: enabled

                                NOTE: * indicates data changed on the server

```

The control subnetwork addresses typically match the most significant three octets of the IP addresses of the server for the media gateway. The most significant three octets are the first three groups of digits in the IP address. Select the `configure server` command on the Maintenance Web Interface to see the IP address of the server.

An asterisk (*) to the right of the **Control Subnet Address** field means that Communication Manager does not have the subnetwork information and the subnetwork address displayed is incorrect.

3. If the information in the **Control Subnet Address** field is incorrect, use the Maintenance Web Interface to change the media server configuration to match the Server IP address in `configure server`. Under Server Configuration and Upgrades, click **Configure Server** to change the media server configuration. Then return to this procedure.
4. Set the **Switch Identifier** field to the switch ID letter. Acceptable switch ID letters are A through J. A is the default setting.
5. Set the **IPSI Control of Port Networks** field to **enabled**.
6. Press **Enter** to save the changes.

Adding the IPSI to the system

Use the IP Server Interface Administration - Port Network SAT screen to add an IPSI. The information on this screen differs, depending on whether the IP addresses of the IPSI are static or assigned automatically through DHCP.

1. Type `add ipserver-interface PNnumber` and press **Enter**.
2. In the **Host** field, enter the IP address for the IPSI that is listed in the **Location** field.

```
add ipserver-interface 8
      IP SERVER INTERFACE (IPSI) ADMINISTRATION - PORT NETWORK 8

                                IP Control? y                Socket Encryption? n
Ignore Connectivity in Server Arbitration? n                Enable QoS? n

Primary IPSI                                                QoS Parameters
-----
Location: 1A01                                             Call Control 802.1p: 6
      Host: 172.22.22.174                                   Call Control DiffServ: 46
      DHCP ID: ipsi-A01a
```

3. Set the **IP Control** field to **y**.
4. Verify that all the other fields are populated and submit the form to save the changes.
5. Repeat this procedure for each port network.

Setting the alarm activation level

1. At the SAT, type `change system-parameters maintenance` and press **Enter**.
2. In the **CPE Alarm Activation Level** field, enter **none**, **warning**, **minor**, or **major**, according to the customer request.
3. Submit the screen to save the changes.
4. Repeat this procedure for each IPSI.

Saving translations

To save the translations to the hard disk drive, at the SAT, type `save translation` and press **Enter**.

Chapter 6: IP interface configuration

This chapter covers the following tasks:

- [Connecting to the IPSIs](#) on page 53
- [IPSI address configuration](#) on page 54
- [Programming the IPSI for DHCP addressing](#) on page 59
- [Programming the IPSI for static addressing](#) on page 54
- [Verifying connectivity to the media server](#) on page 61
- [Verifying that the IPSIs are translated](#) on page 62
- [Upgrading the IPSI firmware version \(if necessary\)](#) on page 62
- [Enabling control of the IPSIs](#) on page 62
- [Verifying the license status](#) on page 62

At a minimum, you must program and connect to the reference TN2312BP IP Server Interface (IPSI) so that the system does not enter No License Mode. Once you connect the IPSIs to the control network, the IPSIs might generate an alarm if the firmware is not the most current. The alarm stops automatically once you upgrade the IPSI firmware.

For how to connect the S8500 Ethernet cables, see [About media server port connections](#) on page 19.

Connecting to the IPSIs

Connect CAT5 cables from the IPSI circuit packs to the dedicated control network or to the customer LAN.

IPSI address configuration

The IPSI circuit pack receives an IP address:

- Statically with static IP addressing, if the control network is nondedicated (public) through the customer network.
- Dynamically with dynamic host configuration protocol (DHCP), if the control network is dedicated (private).

Note:

To program DHCP addressing, you must complete certain sequences within a predetermined time-out interval. Avaya recommends that you read the following procedure completely before you start so that you are familiar with these sequences in advance.

Perform one of the following tasks depending on whether you use static or dynamic addressing:

- [Programming the IPSI for static addressing](#) on page 54
- [Programming the IPSI for DHCP addressing](#) on page 59

Programming the IPSI for static addressing



Important:

If an IPSI is in a port network that is backed up with the Enterprise Survivable Server (ESS) option you must use static addressing for the ESS to provide service to the port network.

You administer the static IP address for the circuit pack directly through the Ethernet port connection on the faceplate (top port). See [Figure 11](#).

Figure 11: Connecting the laptop directly to the IPSI

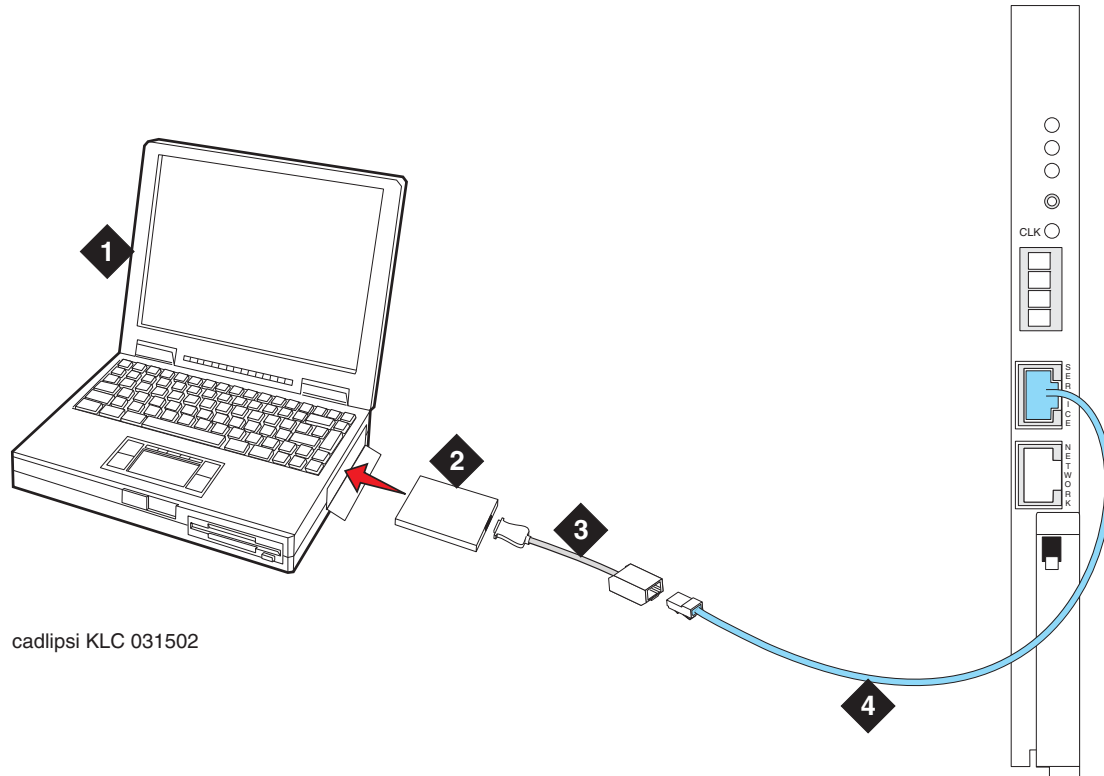

Figure notes:

- | | |
|--|-------------------------------------|
| 1. Services laptop computer | 3. NIC adapter cable (if necessary) |
| 2. PCMCIA Network Interface Card (NIC) | 4. CAT5 crossover cable to IPSI |

Note:

Ensure that you have the password before proceeding.

Depending on the operating system on the Services laptop computer, you might need to clear the Address Resolution Protocol (ARP) cache before entering a new IP address. If you enter an IP address and your computer cannot connect, try clearing the cache.

1. On your laptop computer, click **Start > Run** to open the Run dialog box.
2. Type `command` and click **OK** to open a MS-DOS Command Line window.
3. Clear the Address Resolution Protocol (ARP) cache in the laptop.

Chapter 6: IP interface configuration

- To log into the IPSI, use SSH and the IP address 192.11.13.6.

For information on how to use SSH, see [Accessing the command line interface of the server with SSH](#) on page 87.

Note:

While connected to the IPSI, type `help` or `?` to obtain online help. Most commands have two or three letter abbreviations.

- Type `ipsi login` and press **Enter**.

Note:

The *craft* login used on the IPSI has a different password from the *craft* login used on the media servers.

- Log in as `craft`.

Prompt = [IPADMIN]:

- Type `show control interface` and press **Enter** and then type `show port 1` and press **Enter** to see the current control interface settings.
- To set the control interface, type `set control interface ipaddr netmask` and press **Enter**, where *ipaddr* is the customer-provided IP address and *netmask* is the customer provided subnet mask.

```
TN2312 IPSI IP Admin Utility
Copyright Avaya Inc, 2000, 2001, All Rights Reserved

[IPSI]: ipsi login

Login: craft
Password:

[IPADMIN]: set control interface 135.9.70.77 255.255.255.0

WARNING!! The control network interface will change upon exiting IPADMIN

[IPADMIN]: show control interface

Control Network IP Address = 135.9.70.77
Control Network Subnetmask = 255.255.255.0
Control Network Default Gateway = None
IPSI is not configured for DHCP IP address administration

[IPADMIN]: █
```

- Type `quit` and press **Enter** to save the changes and exit the IPSI session.
- Log back in to the IPSI using SSH.
- Type `show control interface` and press **Enter**.
The system displays IP address, subnet mask, and default gateway information.
Verify that the proper information was entered.

12. If a default gateway is used, enter the gateway IP address with `set control gateway gatewayaddr`, where `gatewayaddr` is the customer-provided IP address for their gateway.
13. Type `quit` and press **Enter** to save the changes and exit the IPSI session.
14. Log back in to the IPSI using SSH.
15. Use `show control interface` to verify the administration.
16. Type `exit` and press **Enter**.

Setting the VLAN and diffserv parameters

1. Connect to the IPSI and log in as `craft`.
2. To display the quality of service values, type `show qos` and press **Enter**.
3. Use the `set` commands in the list below to set the VLAN, diffserv, and port parameters. If the customer does not specify different values, use these recommended values.

Note:

Use **Help** to obtain syntax guidelines for these commands.

**Important:**

The settings for these parameters on the IPSIs must be consistent with the settings on the media servers and other network devices such as Ethernet switches.

- `set vlan priority 6`
 - `set diffserv 46`
 - `set vlan tag on`
 - `set port negotiation 1 disable`
 - `set port duplex 1 full`
 - `set port speed 1 100`
4. Type `show qos` and press **Enter** to check the administered values.
 5. Type `reset` and press **Enter** to capture the updated parameter values.
The reset terminates the administration session and automatically logs you out.
 6. Log in again and use the `show qos` command to ensure that the parameter settings are correct.
 7. Disconnect the laptop from the IPSIfaceplate.

8. Check the LED on the IPSIfaceplate. Verify that the display shows the letters I and P and a filled-in V at the bottom. (See [Figure 12](#)).

Figure 12: IPSI LED display for static address

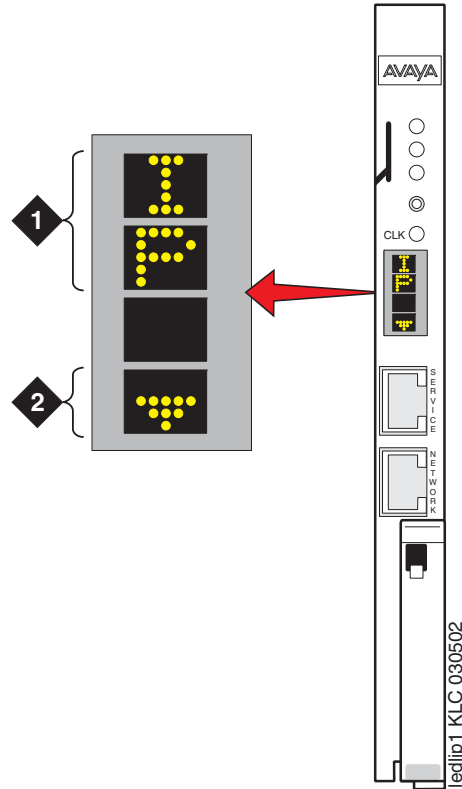

Figure notes:

1. IPSI has a static IP address
2. IPSI has connectivity and an IP address

Note:

Clear the ARP cache on the laptop before connecting to another IPSI. If you do not clear the cache, the laptop appears to stop and does not connect to the next IPSI.

9. Repeat this procedure for each IPSI circuit pack.

Programming the IPSI for DHCP addressing

⚠ Important:

If an IPSI is in a port network that is backed up with the Enterprise Survivable Server (ESS) option you must use static addressing for the ESS to provide service to the port network.

For the TN2312BP IPSI circuit packs to receive IP addresses dynamically, you first must assign the switch ID and cabinet number to each IPSI circuit pack. The switch ID is a single letter, A through J. The cabinet number is a 2-digit number, 01 through 64. For G650 Media Gateways, a cabinet is defined as one or more media gateways connected by a TDM cable. This cabinet configuration is called a G650-rack-mount-stack.

Note:

In the following procedure, you must start step 2 within 5 seconds after inserting the circuit pack.

1. Fully insert the TN2312BP IPSI circuit pack. If necessary, reseal the circuit pack to start the programming sequence.

Note:

For the following step, do not use a graphite pencil.

2. Insert a pen, golf tee, or similar object into the recessed push button switch.

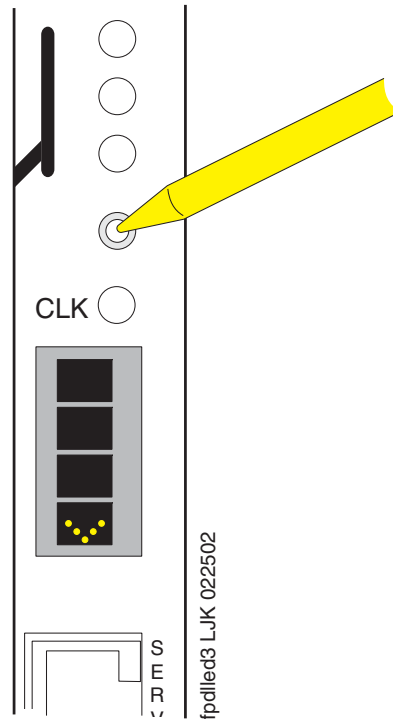

Note:

If you pass the letter or number that you want, you have two options. You can cycle through all the letters or numbers to get to the one you want. Or, you can reinsert, or reseal, the circuit pack and start again.

Note:

If you have only one system, the default switch ID is A. The second system is B and so on. The switch ID is *not* the media gateway or carrier letter.

3. While the display characters are flashing, press the button until the switch ID, A through J, shows on the top character of the LED display. When the correct letter shows, stop. The letter flashes a few times, or 5 seconds, then stops. The next character down starts to flash. This is the first digit of the cabinet number.

Note:

The number to program is the cabinet number, not the port network number. If you have more than one IPSI in a cabinet, they all have the same cabinet number.

4. While the first digit of the number is flashing, press the button until the correct tens digit, 0 through 6, for the cabinet number shows on the display. When the correct digit appears, stop. The digit flashes for about 5 seconds, then stops. Then the second digit starts flashing.
5. While the second digit is flashing, press the button until the correct units digit, 0 through 9, for the cabinet number shows on the display. When the correct digit shows, stop. The digit flashes for about 5 seconds, then stops.

6. All segments of the display go dark for one second. Then, the Switch ID and media gateway stack number shows in the top three characters of the LED display. A "V" is shown in the fourth or bottom character. When the DHCP server assigns an address to the IPSI, the center of the "V" fills in. The filled in "V" looks like the bottom half of a diamond.

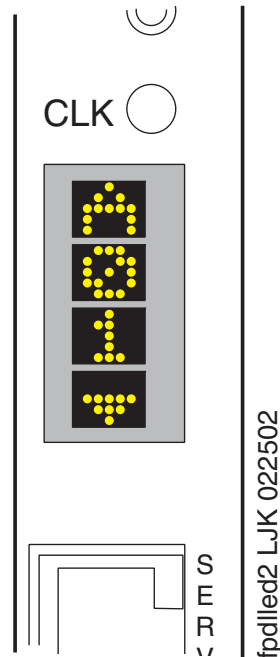

For a duplicated control network, repeat these steps for the second IPSI in the cabinet.

Verifying connectivity to the media server

1. Open the Maintenance Web Interface and log in as **craft**.
2. Under Diagnostics, click **Ping** and select **Other server(s), All IPSIs, UPS(s), Ethernet switches** to verify connectivity to these units.
3. Click **Execute Ping**.
4. Verify that all endpoints respond correctly.

Verifying that the IPSIs are translated

1. Use SSH to open a SAT session on the media server.
2. Type `list ipserver-interface` and press **Enter**.
3. Verify that all ISPI circuit packs are translated.

Upgrading the IPSI firmware version (if necessary)

You might need to upgrade the firmware on some or all the IPSIs. All IPSIs must have the same firmware load.

1. On the Maintenance Web Interface under IPSI Firmware Upgrades, click **IPSI Version**.
2. Select **Query All** and click **View**.
3. Verify the firmware release for each IPSI.
4. If an upgrade is required, follow the procedures in *Firmware Download Procedures* at the Download Center on the Avaya Support web site.

Enabling control of the IPSIs

1. Ensure that the IPSIs have the same, current firmware.
2. On the SAT, type `change system-parameters ipserver-interface` and press **Enter**.
3. Ensure the **IPSI Control of Port Networks:** field is set to **enabled**.
4. Submit the screen to save the changes.

Verifying the license status

On the Maintenance Web Interface, under Security, click **License File** and verify that the license mode is now normal.

Chapter 7: Install an S8500 Media Server as an LSP

Note:

If you are installing the S8500 Media Server as a primary controller, skip this section.

Starting with Release 3.1 of Communication Manager, the Processor Ethernet (PE) interface is supported on the S8500 Media Server. The PE interface enables the S8500 Media Server to operate in Local Survivable Processor (LSP) mode. The PE interface also enables the media server to be the primary controller in an IP configuration with no port networks.

For how to administer PE, see *Administrator Guide for Avaya Communication Manager* (03-300509).

To install a new S8500 Media Server as an LSP, first complete the tasks in *Quick Start for Hardware Installation: Avaya S8500 Media Server*. Then complete the tasks in the previous sections of this document to:

- Install the S8500 Media Server hardware in the 19-inch rack
- Connect the cables between the media server and the network of the customer
- Connect the SAMP card and the modem
- Configure SNMP and the Ethernet switch
- Install Communication Manager
- Configure the S8500 Media Server

When you have completed these tasks, proceed with tasks in this section.

Configuring the media server as an LSP

Note:

Do not install the license file and the authentication file until after you administer the primary controller. For more information, see [Administering the primary controller](#) on page 65.

Note:

Remove the network interface card (NIC) from the S8500 Media Server if a NIC is present. As an LSP, the S8500 Media Server does not use a NIC.

1. Open the Maintenance Web Interface and click **Configure Server**.
2. Click Continue until you get to the page "How do you want to use the Wizard."
3. Select the **Configure Individual Services**.
4. Select **Set Date and Time Zone**. You must set the time of the LSP to the same time zone as the primary controller even if the LSP is physically located in a different time zone.
5. Select **Set Identities**
 - Enter the host name for the LSP.
 - In the **ID** field, check the Server ID (SVID) value. The primary controller is set to SVID 1. If the primary controller is a duplicated S8700-series Media Server, the server IDs are SVID 1 and SVID 2. The ID for an LSP must be greater than 2 and less than or equal to 256. Gaps in the numbering are allowed. For example, SVIDs can be 10, 20, 30, and so on.
 - In the Control Network A field, select the default **Ethernet 0**.
 - In the Services Port field, select the default **Ethernet 1**.
 - In the Corporate LAN field, select the default **Ethernet 0**.
 - In the Control Network B field, select the default **unused**.
 - In the Assign a Processor Ethernet Interface field, select **Corporate LAN**.
6. Click **Continue**.
7. On the Configure Interfaces Web page, enter the following IP addresses:
 - In the **IP address servr1** field, enter the IP address for the LSP.
 - In the **Gateway** field, enter the IP address for the LAN gateway.
 - In the **Subnet mask** field, enter the subnet mask for the LSP.
8. In the **Speed** field, select **Autosense**.
9. Click **Change**.
10. From the list in the left margin, select **Configure LSP or ESS**.
 - Select **This is a local survivable processor (LSP)**.
 - For the **Registration address** field, enter the IP address of a C-LAN that controls the primary controller. If the primary controller is an S8500 Media Server, this address can be a PE IP address, if used, for the primary controller.
 - For the **File Synchronization address at the main cluster** field, enter the physical IP address or addresses of the primary controller media servers. These addresses *must* be connected to the corporate LAN. The IP address *cannot* be the address of a port that is assigned to a control network if the control network is dedicated to the IPSI connection. If the control network or the control networks are dedicated, enter the IP address of the port that is assigned to the corporate LAN.
11. Click **Change** to save your changes.

Administering the primary controller

You must administer the primary controller so that the controller can identify and communicate with the S8500 LSP.

1. At the SAT command line, type `change node-names ip name` and press **Enter**, where *name* is the name of the LSP.
2. In the **Name** column, type the name of the LSP.
3. In the **IP Address** column, type the IP address of the LSP.
4. At the SAT command line, type `add survivable-processor name` and press **Enter**, where *name* is the LSP name from the Node Names screen.

The system displays the Survivable Processor screen.

```

add survivable-processor sv-mg2-lsp                                     Page 1 of xx

      SURVIVABLE PROCESSOR - PROCESSOR ETHERNET

      Node Name: sv-mg2-lsp
      IP Address: 128.256.173.101
      Type: LSP

      Network Region: 1
  
```

5. The Type field is automatically populated with **LSP**. **LSP** appears in the field if the node name is *not* associated with ESS.
6. Enter a network region for the LSP. The default is **1**. However, a different network region might be better suited for the LSP to provide media gateway and IP telephone support.
7. On pages 2 and 3 of the screen, add any adjuncts that the LSP can support if a failover from the primary controller occurs.

For how to administer the Survivable Processor form, see *Administrator Guide for Avaya Communication Manager* (03-300509).

Enabling license server capability on a media gateway

If a G250 or G350 Media Gateway provides the serial number, access the *administration level* command line of the media gateway and run the command `ip license-server`. If a G700 Media Gateway provides the serial number for the S8500 LSP license, skip this step and continue with [Installing and verifying the license on the new LSP](#) on page 66.

Note:

The gateway that provides the serial number must be connected to the LSP such that it remains connected in the event of a network failure.

Installing and verifying the license on the new LSP

On the S8500 LSP, install a new license file with the appropriate settings for an LSP server.

To install the license file and the authentication file, complete the following steps:

1. On the Maintenance Web Interface, under Security, click **License File**.
2. Select **Install the license I previously downloaded** and click **Submit** to install the license file.

 **Important:**

The system displays a message that warns you that the license requires a restart. Do *not* restart the server at this time.

3. Under Security, click **Authentication File**.
4. Select **Install the Authentication file I previously downloaded** and click **Install**.
The system tells you the authentication is installed successfully.
5. Restart Communication Manager to sync the license for LSP status.
 - a. Access the server command line interface using an SSH client, like PuTTY, and an IP address of 192.11.13.6.
 - b. Type `stop -caf`
 - c. Type `start -caf`
6. To verify that the S8500 Media Server that you are converting is licensed as an LSP:

Note:

When you access the SAT screen before you reset the system, the screen might indicate "License mode not available." This problem is resolved after the reset.

- a. Open a SAT session on the LSP and type `display system-parameters customer-options` and press **Enter**.
- b. On the System-Parameters Customer-Options form, verify that the Local Survivable Processor field is set to **y** and verify that the Processor Ethernet field is set to **y**.

Opening the TCP ports on the S8500 LSP

You can open various TCP ports for Processor Ethernet (PE) on the firewall to enable the connections to work for the LSP.

1. In the Maintenance Web Interface, under Security, click **Firewall**.

The system displays the Firewall Web page.

Note:

The ftp, telnet, and tftp services are not required.

2. In the Input to Server column, ensure that the check box for **snmp** is selected.
3. Click **Advanced Setting**.

The system displays the Advanced Firewall Settings Web page.

4. Verify that the following defaults are set:

- **Output to server** is selected for **gateway compatibility**, ports **1024:65535**
- **Input to server** is selected for **ip-signaling-1**, ports **5000:5021/tcp**
- **Input to server** is selected for **ip-signaling-2**, ports **5024:9999/tcp**
- **Input to server** is selected for **h248message**, port **2945/tcp**
- **Input to server and Output to server** is selected for **filesync**, port **21874/tcp**
- **Input to server and Output to server** is selected for **h323gatestat**, port **1719/udp**
- **Input to server and Output to server** is selected for **h323hostcall**, port **1720/tcp**

If any of the defaults are set incorrectly, contact your sales representative.

5. Click **Standard Service** to return to the first Firewall page, and then click **Submit**.

Resetting the S8500 LSP

Use the reset command to notify all processes of the new parameters:

Note:

When you access the SAT screen before you reset the system, the screen might indicate a license mismatch. This problem is resolved after the reset.

From the SAT command line, type `reset system 4` and press **Enter**.

The system resets. The system also registers with the primary controller and receives the translations from the primary controller.

Verifying that the primary controller identifies the new LSP

1. Wait several minutes after you reset the S8500 LSP. On the primary controller, run the SAT command `list survivable-processor` to verify that the LSP server registers, and that translations are updated.
2. If the LSP is registered, the Service State? field shows `in-service` and the Translations Updated field shows the time and the date of the update.

```
list survivable-processor                                     Page 1 of xx
```

SURVIVABLE PROCESSORS					
Name	Type	ID	IP Address	Service State?	Translations Updated
LSPNYC	LSP	04	128.256.173.101	in-service/idle	03:21 02/19/03
LSPCHI	LSP	05	128.256.113.213	out-of-service	04:32 02/20/03

Readministering media gateways to point to the LSP

Change the controller list for each G700, G350, or G250 Media Gateway that uses the LSP as an alternate controller. This change enables the media gateway to seek service from the LSP if the connection to the primary controller fails.

For how to change the controller list of the media gateway, see one of the following documents:

- *Installation and Upgrades for the Avaya G700 Media Gateway and Avaya S8300 Media Server, 555-234-100*
- *Installation and Upgrades for the Avaya G250 Media Gateways, 03-300434*
- *Installation and Upgrades for the Avaya G350 Media Gateway, 03-300394*

Chapter 8: Postinstallation administration

This section covers the following tasks:

- [Verifying translations](#) on page 69
- [Setting rules for daylight savings time](#) on page 70
- [Setting locations \(if necessary\)](#) on page 71
- [Verifying the date and the time](#) on page 72
- [Clearing and resolving alarms](#) on page 72
- [Backing up files to the compact flash media](#) on page 75
- [Enabling alarms to INADS by way of a modem](#) on page 75
- [Enabling alarms to INADS by way of the SNMP module](#) on page 76
- [Before leaving the site](#) on page 76

Verifying translations

1. Open a SAT session on the media server.
2. To view all the administered circuit packs in the system, type `list configuration all` and press **Enter**.
3. To verify the location of the IPSI circuit packs, type `list ipserver-interface` and press **Enter**.

For more information, see your planning documents and check the administration status on the following items:

- `list station`
- `list trunk-group`
- `list hunt-group`

Setting rules for daylight savings time

You set the date, the time, and the time zone through the Maintenance Web Interface on the media server. You must use SAT commands to set the rules for daylight savings time.

Note:

The Daylight Savings Rules screen reflects the new dates for Daylight Savings Time that take effect in 2007.

1. Type `change daylight-savings-rules` and press **Enter**.
2. In the **Change Day, Month, Date, Time, and Increment** columns, type the appropriate start and stop information for each rule. For example, **1:00** in the **Increment** field means to move the clock forward or back by one hour at the transition point.

You can set up to 15 customized daylight savings time rules. If you have media gateways in several different time zones, you can set up rules for these media gateways on a per-location basis. A daylight savings time rule specifies the exact time when you want to transition to and from daylight savings time. The rule also specifies the increment at which to make the transitions.

Note:

The default daylight savings rule is **0**, which means that no daylight savings transition occurs. You can change any rule except rule 0. You cannot delete a daylight savings rule if the rule is in use on either the Locations screen or the Date and Time screens.

3. When you finish, submit the screen to save the changes.

Setting locations (if necessary)

After you set the rules for daylight savings time, you must set the locations for all port networks. Port networks can be in different time zones. Use SAT commands to set the locations for the port networks.

1. Type `change locations` and press **Enter**.

```
change locations                                     Page 1 of 5
                                                    LOCATIONS
                                                    ARS Prefix 1 Required For 10-Digit NANP Calls? y
Number  Name                Timezone  Daylight-Savings  Number Plan
        Name                Offset    Rule              Area Code
  1     Main                + 00:00  0
  2     CA                  - 02:00  0
  3
  4
  5
  6
  7
  8
  9
 10
 11
```

2. In the ARS Prefix 1 Required for 10-Digit NANP Calls? field, type **y**.
3. Type the information in the various fields for each media gateway.
In the Name field for location 1, type **Main**.
4. Submit the screen to save the changes.

Verifying the date and the time

Use SAT commands to verify the date and time.

1. Type `display time` and press **Enter**.

```
display time                                     Page 1 of 1
                                         DATE AND TIME

      DATE

      Day of the Week: Friday           Month: June
      Day of the Month: 9              Year: 2006

      TIME

      Hour: 14 Minute: 19 Second: 36   Type: Standard

      Daylight Savings Rule: 0

WARNING: Changing the date or time may impact BCMS, CDR, SCHEDULED
```

2. Verify that the date and the time are correct.
3. In the Daylight Savings Rule field, verify that the correct rule number is displayed.
4. If the rule number is correct, you are finished with this task.
5. If the rule number is not correct, go to the Maintenance Web Interface.
6. Under Server, click **Server Date/Time**. Verify that the date and the time are correct. If not, set the correct date and the correct time.
7. Repeat Steps 1 through 3.

Clearing and resolving alarms

1. On the Maintenance Web Interface, under Alarms, click **Current Alarms**.
You can resolve alarms on the *active* media server only.
2. Select the server alarms to clear and click **Clear**.
3. Using SAT commands or other standard troubleshooting procedures, to resolve any major alarms.

Enabling and disabling the Ethernet switch ports

You might want to disable unused ports on the Avaya Ethernet switch, if used.

1. To select an Ethernet switch to administer, under Security, click **Ethernet Switch Ports**.

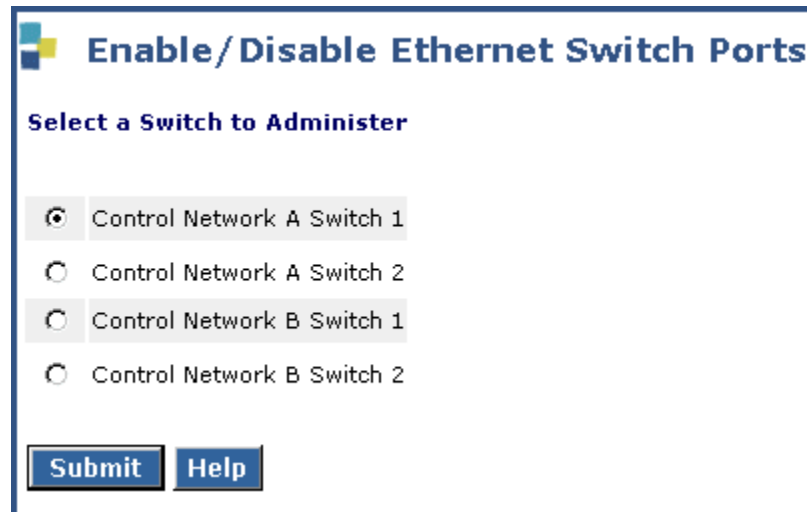

The screenshot shows a web interface titled "Enable/Disable Ethernet Switch Ports". Below the title is the instruction "Select a Switch to Administer". There are four radio button options: "Control Network A Switch 1" (selected), "Control Network A Switch 2", "Control Network B Switch 1", and "Control Network B Switch 2". At the bottom of the form are two buttons: "Submit" and "Help".

Chapter 8: Postinstallation administration

2. Select the switch you want to administer and click **Submit**.

Enable/Disable Ports for Control Network A Switch 1

Port	Enable	Disable
1	<input checked="" type="radio"/>	<input type="radio"/>
2	<input checked="" type="radio"/>	<input type="radio"/>
3	<input checked="" type="radio"/>	<input type="radio"/>
4	<input checked="" type="radio"/>	<input type="radio"/>
5	<input checked="" type="radio"/>	<input type="radio"/>
6	<input checked="" type="radio"/>	<input type="radio"/>
7	<input checked="" type="radio"/>	<input type="radio"/>
8	<input checked="" type="radio"/>	<input type="radio"/>
9	<input checked="" type="radio"/>	<input type="radio"/>
10	<input checked="" type="radio"/>	<input type="radio"/>
21	<input checked="" type="radio"/>	<input type="radio"/>
22	<input checked="" type="radio"/>	<input type="radio"/>
23	<input checked="" type="radio"/>	<input type="radio"/>
24	<input checked="" type="radio"/>	<input type="radio"/>
25	<input checked="" type="radio"/>	<input type="radio"/>
26	<input checked="" type="radio"/>	<input type="radio"/>

Submit Changes **Help**

3. Locate the ports that you want to disable and select **Disable** in that row.
4. Click **Submit Changes**.

Backing up files to the compact flash media

Note:

Avaya requires the use of industrial grade compact flash media. For more information, see *Hardware Description and Reference for Avaya Communication Manager* (555-245-207).

1. Connect the compact flash drive to one of the USB ports on the front of the media server.
2. Insert the compact flash media into the top right slot of the drive.
3. On the Maintenance Web Interface, under Data Backup/Restore, click **Backup Now**.
4. Select all applicable data sets.
5. To back up the data onto the compact flash media, select **Local PC Card**.
To format a new media card, also select **Format PC Flash**.

Note:

You must format the compact flash media before the first use only.

6. Click **Start Backup**. The system displays a message when the format is completed, which takes approximately 10 seconds.

Note:

If you click **Start Backup** without media in the compact flash drive, you cause a system error. In this case, repeat the steps beginning with Step 1.

7. To view the status of the backup, click **Backup Status**.

Enabling alarms to INADS by way of a modem

Note:

Enable alarms on both media servers on a duplicated system.

1. Start an SSH session on the media server.
2. Type `almenable -d b` and press **Enter**.
3. To verify that the alarms are enabled, type `almenable` and press **Enter**.

Enabling alarms to INADS by way of the SNMP module

Note:

Perform this procedure only if the installation includes a Secure Service Gateway (SSG).

To enable alarms on the media servers:

1. Start an SSH session on the media server.
2. Type `almsnmpconf -d ipaddress -c communityname` and press **Enter**, where *ipaddress* is the trap receiver address for the SSG device and *communityname* is the community string name that the SSG device requires.
3. Type `almsnmpconf` and press **Enter** and verify that the correct information is entered.
4. Type `almenable -s y` and press **Enter**.
5. Type `almenable` and press **Enter** and verify that alarm origination is enabled on the SNMP module. If used, also verify that alarm origination by way of a modem is still enabled.
6. Log off.

Before leaving the site

- Provide the default LAN security settings to the customer.
- Ensure that the customer knows that remote access to the media server is available only if the following services are enabled on the Maintenance Web Interface Firewall screen:
 - **SSH** must be enabled
 - **https** must be enabled to access the Maintenance Web Interface
 - **def-sat** must be enabled to access the SAT commands
 - **162/udp** must be enabled to receive SNMP traps from the UPS and the Avaya Ethernet switch

Chapter 9: Installation verification

This chapter provides the following information about how to verify the media server installation and configuration:

- Testing the IPSI circuit packs
- Testing the license file
- Checking LED status indicators
 - Media servers
 - Avaya Ethernet switches
 - Uninterruptible power supplies (UPSs)
 - Circuit packs

Testing the IPSI circuit pack

The following steps test the clock and packet interface components within the TN2312BP IPSI circuit pack.

1. In a SAT command line, type `test ipserver-interface UUC` and press **Enter**, where *UUC* is the cabinet and the carrier in which the circuit pack is located.
2. Verify that the Test Results screen shows PASS in the Results column.

Testing the license file



Important:

Wait at least 30 minutes after you install the Communication Manager license before you run this test.

1. On a SAT command line, type `test license` and press **Enter**.
2. Verify that the Test Results screen shows PASS in the Results column.

S8500 LEDs

The Avaya S8500 Media Servers have five or six LEDs on the front and four LEDs on the back. The S8500B and S8500C have the same LEDs but in different locations. The S8500B can have an additional LED indicating activity on the optional floppy disk drive. The S8500C does not support a floppy disk drive.

The SAMP module has no LEDs.

[Figure 13: S8500C front panel](#) on page 78 and [Figure 14: S8500B front panel](#) on page 79 show the locations of the front-panel LEDs on the S8500C and S8500B.

Figure 13: S8500C front panel

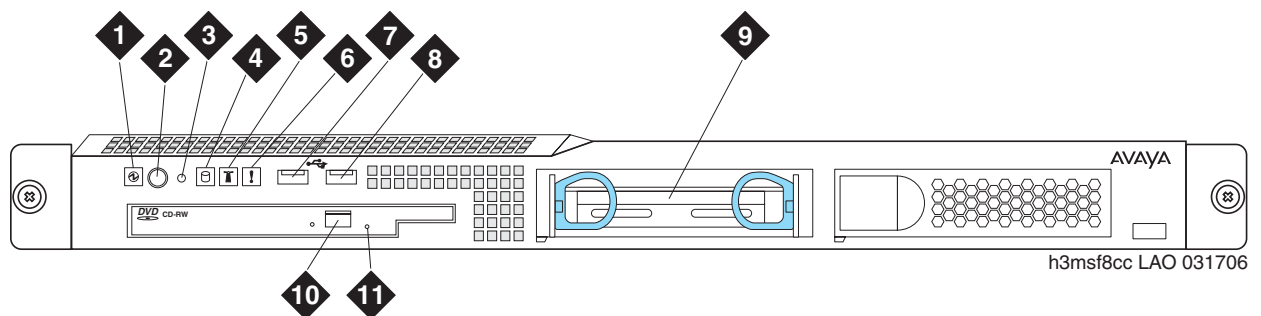
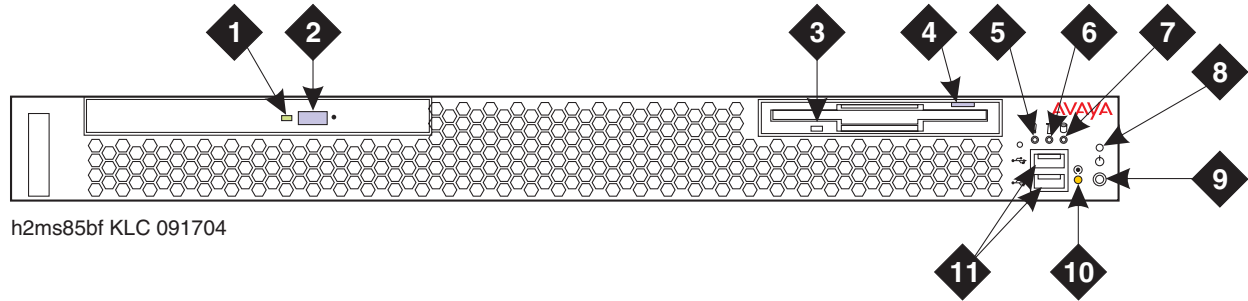

Figure notes:

- | | |
|---------------------------------|-------------------------------|
| 1. Power-on LED | 7. USB port |
| 2. Power button | 8. USB port |
| 3. Reset button | 9. Hard disk drive |
| 4. Hard disk drive activity LED | 10. CD eject button |
| 5. Locator LED | 11. CD-ROM drive activity LED |
| 6. System error LED | |

Figure 14: S8500B front panel

h2ms85bf KLC 091704

Figure notes:

- | | |
|--|---|
| <ul style="list-style-type: none"> 1. CD-ROM drive activity LED 2. CD-ROM eject button 3. Diskette drive activity LED 4. Diskette eject button 5. System error LED 6. System locator LED. 7. Hard disk drive activity LED | <ul style="list-style-type: none"> 8. Power on LED 9. Power control button 10. Reset button — Press to reset the media server and run the power-on self-test (POST). 11. USB connections for the compact flash drive. |
|--|---|

The functions of the front-panel LEDs are as follows:

Table 7: S8500 front-panel LEDs

LED	Description
Power on	When lit and not flashing, the media server is turned on. When flashing, the media server is turned off and still connected to the AC power source. When off, AC power is not present, or the power supply or the LED failed.
Hard disk drive	When on or blinking, indicates HDD activity.
Locator	Use this blue LED to locate the media server if the media server is in a location with numerous other media servers.
System error	When on, indicates a system error.
CD-ROM drive	When on or blinking, indicates activity on the CD-ROM drive.
Floppy disk drive (S8500B only)	When on or blinking, indicates activity on the FDD drive.

[Figure 15: Rear view of S8500B Media Server](#) on page 80 shows the Ethernet port LEDs on the back panel of the S8500B. Each port connector has two LEDs, one for transmission activity and one to indicate the transmission speed. The port LEDs on the S8500C are the same as on the S8500B.

Figure 15: Rear view of S8500B Media Server

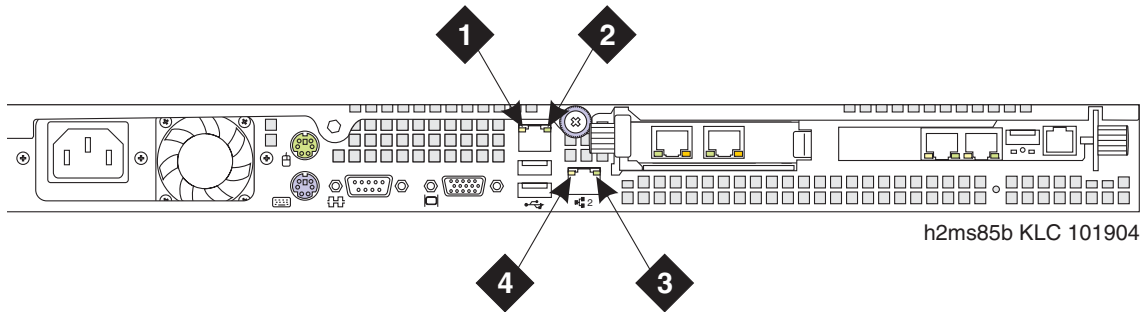

Figure notes:

- 1. Speed 1 Gbps LED on Eth 0.
- 4. Speed 1 Gbps LED on Eth 1.

When lit, these LEDs indicate that the Ethernet network speed is 1 Gbps. When off, these LEDs indicate that the Ethernet network speed is 10 Mbps or 100 Mbps.

- 2. Transmit/receive activity LED on Eth 0.
- 3. Transmit/receive activity LED on Eth 1.

When lit, these LEDs indicate activity between the media server and the network.

Note:

On the S8500C, the Ethernet ports are located below the dual NIC but the port LEDs have the same location and function as shown in [Figure 15](#). See [Figure 2: S8500C back panel](#) on page 11.

Additional media server LED information

For more information on media server LEDs, see *Maintenance Procedures for Avaya Communication Manager, Media Gateways and Servers*, 03-300432.

Avaya C360 Ethernet switch LEDs

The C360 series converged, stackable, Ethernet switches include:

- C363T: 24-port
- C363T-PWR: 24-port power over Ethernet (PoE)
- C364T: 48-port
- C364T-PWR: 48-port PoE

The front panel of the C360-Series switches has:

- One port LED that is associated with each port
- Three system status LEDs
- Seven port function LEDs

The C363T-PWR and the C364T-PWR switches have an additional PoE LED. The port function LEDs are selectable with a set of two left/right buttons. The port LEDs display the status of the selected function for each port.

For more information about the on/off and blinking states of the LEDs, see the documentation for the Ethernet switch.

System and port function LEDs on C360 Avaya Ethernet switches

LED Name	Description
System LEDs	
PWR	Power status
SYS	System status
ROUT	Routing mode
Port Function LEDs	
LNK	Link status
COL	Collision status
Tx	Transmit to line
Rx	Receive from line
FDX	Full duplex mode
Hspd	High-speed mode
LAG	Link aggregation group for trunking
PoE (PWR versions only)	Power over Ethernet status

UPS LEDs

The UPS LEDs flash briefly after the UPS is plugged in. The normal mode LED flashes after a self-test to indicate that the UPS is in standby mode.

For more information, see the UPS user guide for the Powerware UPS.

Figure 16: LEDs on the Powerware 9125 UPS

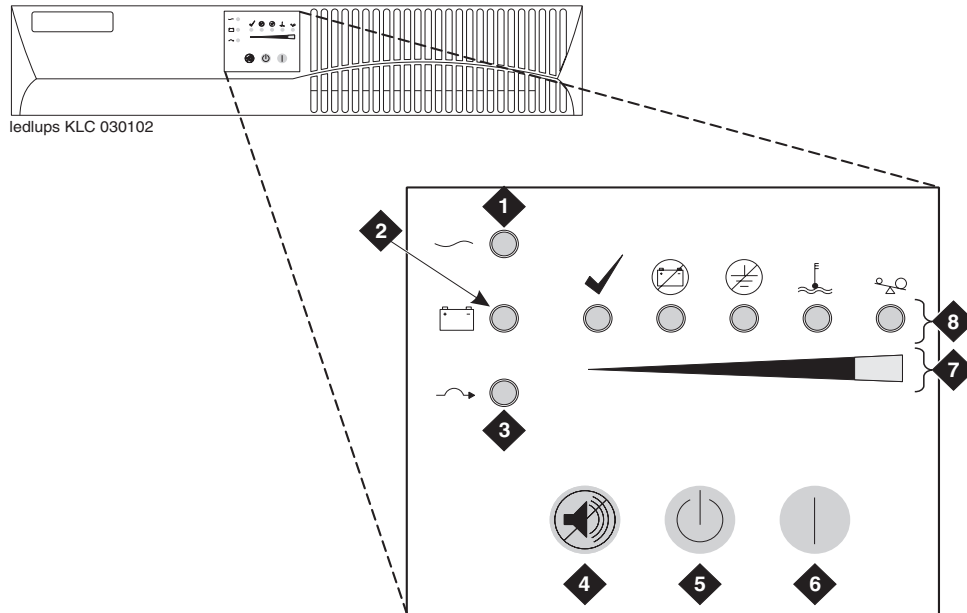

Figure notes:

- | | |
|----------------------------|-------------------------|
| 1. Normal mode indicator | 5. Off button |
| 2. Battery mode indicator | 6. On button |
| 3. Bypass mode indicator | 7. Bar graph indicators |
| 4. Test/Alarm reset button | 8. Alarm indicators |

TN2312BP IPSI LEDs

TN2312BP IP Server Interface (IPSI) circuit pack LEDs include:

- Standard LEDs and connector slots ([Figure 17: TN2312BP IPSI circuit pack faceplate](#) on page 84)
- A programmable LED display, which indicates:
 - The type of IPSI IP address. For a dynamic address, the display shows media gateway the location of the media gateway. For a static address, the display shows I P. ([Figure 18: IPSI LED display for a static IP address](#) on page 85)
 - Connectivity

Figure 17: TN2312BP IPSI circuit pack faceplate

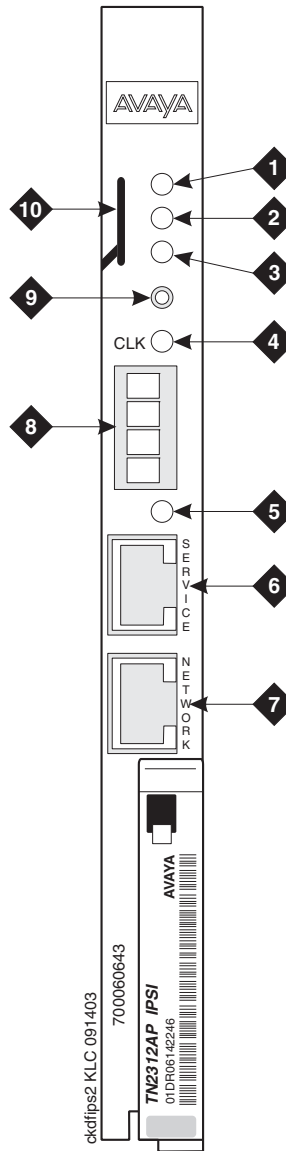
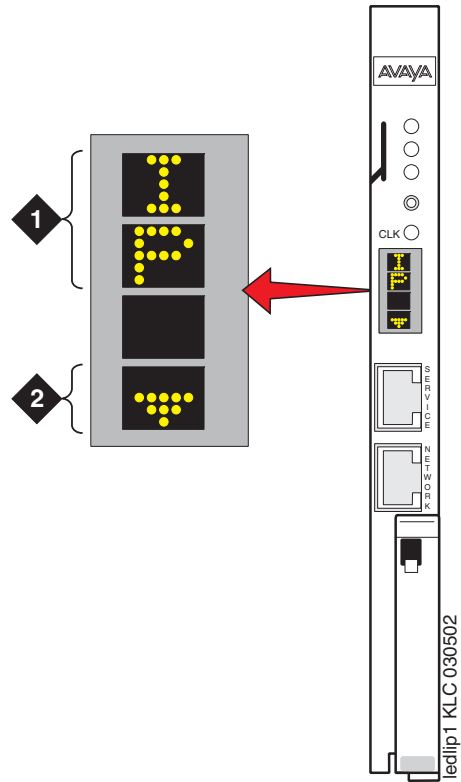

Figure notes:

- | | |
|-----------------------------------|------------------------------------|
| 1. Red LED | 6. Services RJ45 connector |
| 2. Green LED | 7. Network control RJ45 connector |
| 3. Amber LED | 8. Four-character LED display |
| 4. Yellow LED (tone clock status) | 9. Pushbutton switch |
| 5. Emergency transfer LED | 10. Slot for the maintenance cable |

Figure 18: IPSI LED display for a static IP address**Figure notes:**

1. The IPSI has a static IP address.
 2. The IPSI has connectivity and an IP address.
-

Figure 19: IPSI LED display indicating connectivity status for a DHCP IP address

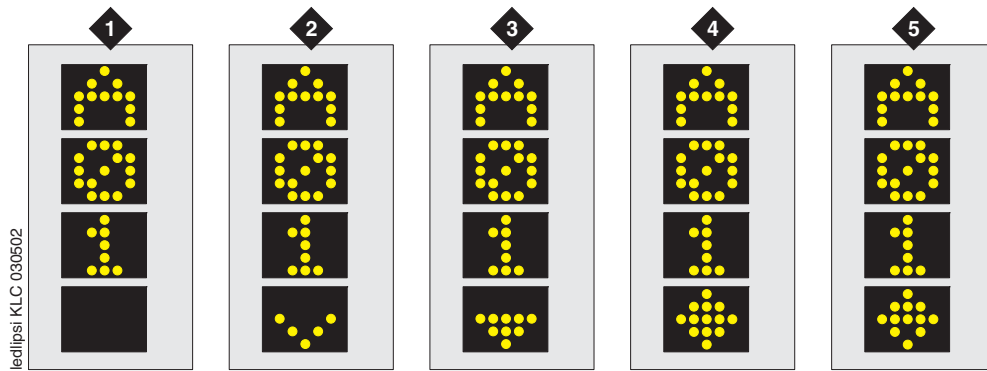

Connectivity status	1	2	3	4	5
The IPSI is connected to a media server.	No	Yes	Yes	Yes	Yes
The IPSI has an IP address.	No	No	Yes	Yes	No
The Services laptop computer is connected to the IPSI services port.	No	No	No	Yes	Yes

Appendix A: Media server access

Use a personal computer or a Services laptop computer that is equipped with a network interface card (NIC), a terminal emulation program, and a Web browser to access a media server for initial configuration, aftermarket additions, and continuing maintenance.

You can access the media server:

- Directly
- Remotely over the customer network
- Remotely over a modem (for Avaya maintenance access only)

Steps to access a media server include:

- [Connecting to the media server directly](#) on page 89
- [Connecting to the media server remotely over the network](#) on page 91
- [Connecting to the media server remotely over a modem](#) on page 91
- [Logins for Avaya technicians and BusinessPartners](#) on page 93
- [Configuring the network for Windows 2000 and XP](#) on page 94

Accessing the command line interface of the server with SSH

The procedure in this section shows how to use SSH to log on to the media server from a Services laptop computer. SSH is the recommended method for media server access. To use this procedure with a cable connection from the computer to the Services port, you must configure the computer for the network connection.

To use SSH, a third-party SSH client must be installed on your computer. PuTTY is one such client. You can download PuTTY from <http://www.putty.nl/download.html>. The following procedure describes, as an example of SSH access, how to log on to the server command line with PuTTY.

Note:

A version of PuTTY that is defaulted for SSH server access is available for Avaya Services personnel only. In this version, some values shown in the procedure below are pre-selected.

Note:

Many Avaya products support access with SSH. However, Avaya does not provide support for third-party clients that are used for SSH access. Problems with an SSH client, including PuTTY, are the responsibility of the user or the SSH client vendor.

1. On your computer, click on the **PuTTY** desktop link or click **Start > Programs > PuTTY > PuTTY**.

The system displays the PuTTY Configuration window with the Session dialog box open.

2. In the Host Name or IP address field, type **192.11.13.6** if you want to connect to the Services port. For access over the LAN or WAN, type the IP address or the host name of the server.
3. In the Port field, type **22**.
4. Under Protocol, select **SSH**.
5. In the PuTTY menu on the left, click **Connection > SSH**.
6. In the Preferred SSH protocol version field, select **2**.
7. In the Encryption options window, use the up and down arrows to set AES (SSH-2) as the top option and 3DES as the second option.

Note:

You can also customize the PuTTY tool with other settings, such as for color. For documentation on PuTTY, see <http://www.putty.nl/docs.html>.

8. In the **Backspace key** area, select **Control-H**.

This activates the backspace key while you are using the SAT.

9. Click **Open**.

Note:

If you have not connected to this particular server before, SSH prompts you to accept the server's host key. If you save this key when prompted, you will not be prompted if you connect again later. If you do not save the key, PuTTY prompts you the next time you connect to this server.

When you connect through the interface on the Services laptop computer, if you save the host key, the host is identified as 192.11.13.6. If you later connect to a different server through the laptop interface, this new host also shows as 192.11.13.6, but it has a different key. You get a prompt in this case because it appears that the host key has changed.

10. If necessary, click **Yes** to accept the server's host key.

The system displays the PuTTY window.

11. Log in as **craft**.

Connecting to the media server directly

To access the media server directly, use a computer with the following minimum specifications:

- A Windows 2000 or Windows XP operating system
 - 32-MB of RAM
 - 40-MB of available disk space
 - An RS-232 port connector
 - A network interface card (NIC) with a 10/100BaseT Ethernet interface
 - A 10/100 BaseT Ethernet, category 5 or better, cross-over cable with an RJ45 connector on each end (MDI to MDI-X)
 - A CD-ROM drive
1. Plug one end of the CAT5 cable into the Services access port on the back of the media server. For more information, see [Services laptop computer connected directly to the S8500 Media Server](#) on page 90. Plug the other end of the CAT5 cable into the NIC on your computer. Use a NIC adapter if necessary.
 2. Configure your network connection
 - IP address: 192.11.13.5
 - Subnetwork mask: 255.255.255.252

For specific information, see [Configuring the network for Windows 2000 and XP](#) on page 94.

Once you connect, use a terminal emulation program or a Web browser to administer the media server.

Figure 20: Services laptop computer connected directly to the S8500 Media Server

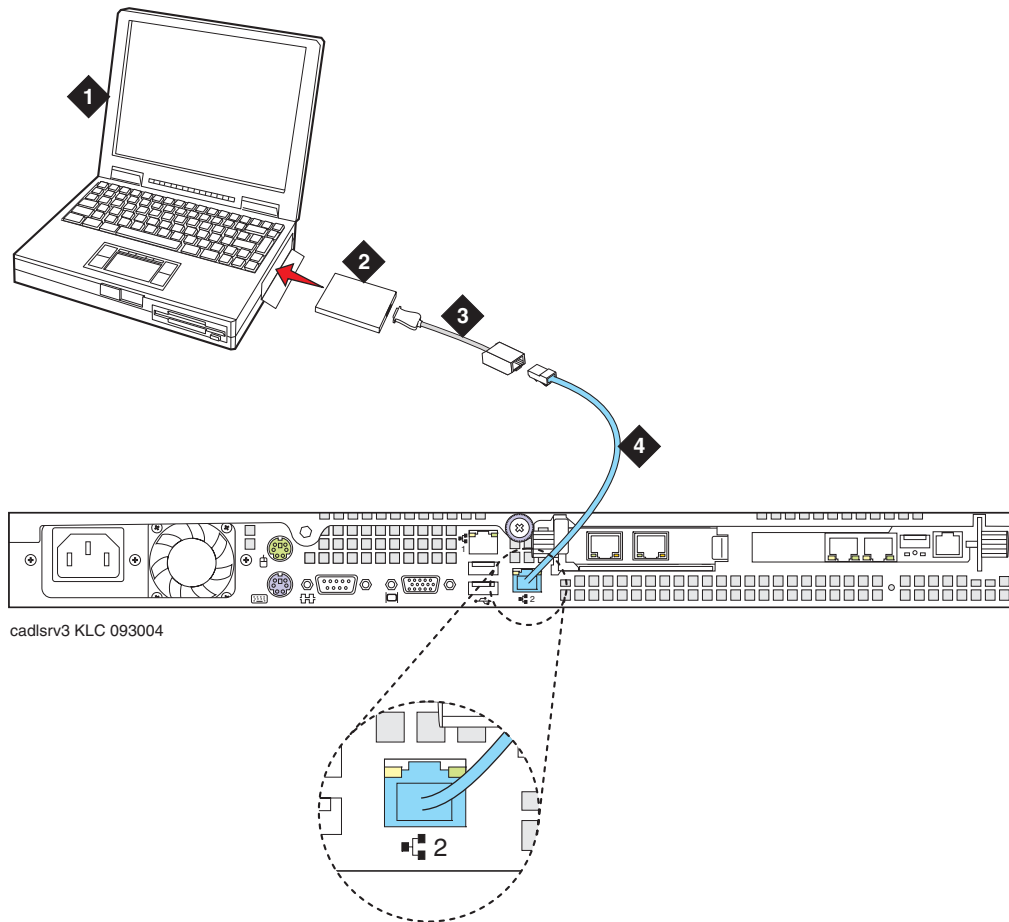

Figure notes:

- | | |
|---------------------------------|-------------------------------------|
| 1. Services laptop computer | 3. NIC adapter cable (if necessary) |
| 2. Network interface card (NIC) | 4. CAT5 cross-over cable |

Note:

The layout of the hardware components on the back panel of the S8500C is different from the layout on the S8500B. However, the laptop computer connects to the port labeled "2" on the back panel in both cases. This port is referred to as "Eth1" when configuring the server. See .

Connecting to the media server remotely over the network

You can use any computer to connect to the media server through a LAN. The security settings on the LAN must allow remote access.

1. Open a Web browser or a terminal emulation application.
2. In the address field, enter the IP address or the DNS host name that is assigned to the media server that you want to access.

Connecting to the media server remotely over a modem

Note:

Remote access over a modem is for Avaya services support access only and not for routine administration. Because the media server uses the same modem line to report alarms, the server cannot report new alarms while the line is in use.

You can access the media server through an analog modem. The remote connection requires a minimum data speed of 33.5 kilobits per second.

On the S8500 Media Server, access the media server through the remote maintenance board (SAMP) that is installed in the media server. For how to access the SAMP, see *Using the Avaya Server Availability Management Processor (SAMP)* (03-300322).

1. Launch the dial-up connection program, which varies depending on your operating system. Generally, you can access the program through the My Computer or the Control Panel folders. For more information, see the Help system of your computer.
2. To open the New Connection wizard, double-click **Make New Connection**.
3. Within the wizard, depending on your operating system, you may be asked to:
 - Assign a name to the connection.
 - Select dial-up to the network for the network connection type.
 - Select the modem you will be using for the dial-up connection.
 - Enter the appropriate telephone number to access the active server. For the customer-supplied telephone numbers, see the completed *Electronic Preinstallation Worksheet*.
 - Under Advanced, select **PPP** and log on manually. You might have to type a user name and password, depending on whether or not the media server that you are dialing into has a non-null CHAP secret key. If you need a user name and a password, use **craft** for the user name and ignore the password field.
4. Click the connection name or icon, if created. Wait for connection.

Appendix A: Media server access

5. When prompted, enter your remote access login name and password.
6. When the system displays the **Start PPP now** message, click **Done**. When you see the Connection Complete dialog box, your computer is connected to the media server.
7. Open an SSH session using PuTTY or other client.
See [Accessing the command line interface of the server with SSH](#) on page 87 for more information.
8. Within the SSH client, type the IP address of the active media server.

Accessing the Maintenance Web Interface

You can administer the media server through the Maintenance Web Interface. Access the Maintenance Web Interface when connected:

- Over the customer network with MS Internet Explorer 5.5 or 6.0.
- Directly to the Services port on the media server. For more information, see [Services laptop computer connected directly to the S8500 Media Server](#) on page 90.

To access the Maintenance Web Interface, you must first bypass any proxy servers.

1. In Internet Explorer, click **Tools > Internet Options**.
2. Click the **Connection** tab.
3. Click **LAN Settings** in the lower right, then click **Advanced**.
4. In the Exceptions box after the last entry, type **192.11.13.6**
5. Click **OK** to close each of the dialog boxes.
6. Open the MS Internet Explorer Web browser to access the Maintenance Web Interface.
 - If you are connected directly, in the **Address** field, type **192.11.13.6**.
 - If you are connected remotely through a modem, in the **Address** field, type in the IP address or the DNS host name of the media server.

Note:

The first time that you log in, you see a message that asks you to install a security certificate. Follow the instructions for your particular browser to accept the certificate. You can also install the certificate on your computer with the instructions in the online Help for your browser.

7. When prompted, log in.
8. When you see a message that asks **Do you want to suppress alarms?**, select **Yes**.
9. Click **Launch Maintenance Web Interface**.

Using the SAT command line prompt

Use a remote Secure Shell (SSH) or terminal emulation session to access the Communication Manager SAT command line prompt.

Type of connection	Procedure
Using SAT with SSH:	See Accessing the command line interface of the server with SSH on page 87.
Using SAT with Terminal Emulation	<p>To use a command line interface in a terminal emulation window, open your terminal emulation application. Configure the terminal emulation program port settings as follows:</p> <ul style="list-style-type: none"> ● Speed: 115200 baud or 9600 baud if you use a serial modem connection ● No parity ● 8 data bits ● 1 stop bit ● No flow control <p>NOTE: Avaya Native Configuration Manager, Avaya Terminal Emulation, and HyperTerminal are the only terminal emulation programs that Avaya supports.</p> <p>Use either the IP address or the DNS host name to establish a network connection to the media server. Use port 5023 for this connection. When prompted, log in.</p>

Logins for Avaya technicians and BusinessPartners

Avaya field technicians and BusinessPartners must use a Services login such as **craft** or **dadmin** to perform initial configuration and upgrades. An Avaya field technician can use a unique password that is assigned to the customer system.

After the Avaya authentication file is installed, Avaya Communication Manager has a password for the **craft** login that is unique to the customer system and available when you are connected directly to the media server. Log in as **craft** and use this password to bypass the ASG challenge and response. Every other means of **craft** access requires an ASG challenge and response. The revised password is recorded by RFA and is obtained from ASG Conversant at 1-800-248-1234 or 1-720-444-5557.

Customers can set up their own logins to access Avaya media servers. You must have superuser permission to create or change logins and passwords. NOTE: do not start login IDs with a number. For more information, see the *Avaya Communication Manager Basic Administration Quick Reference* (03-300363).

Configuring the network for Windows 2000 and XP

Important:

Write down the original settings for use in case you need to revert to the original configuration.

1. On your computer desktop, right-click **My Network Places** and left-click **Properties** to display the Network Connections window.

Windows 2000 or Windows XP should automatically detect the Ethernet card in your system and create a LAN connection. More than one connection might appear.
2. Right-click on the correct **Local Area Connection** and left-click **Properties** to display the Local Area Connection Properties dialog box.
3. Select **Internet Protocol (TCP/IP)**.
4. Click **Properties** to display the Internet Protocol (TCP/IP) Properties dialog box.
5. On the General tab, select **Use the following IP address**.
6. Make a note of any IP addresses or other entries that you have to clear. You might need to restore them later to connect to another network

Enter the following:

- IP address: 192 . 11 . 13 . 5
 - Subnet mask: 255 . 255 . 255 . 252
7. Select **Use the following DNS server addresses**. The entries for Preferred DNS server and Alternate DNS server should both be blank.
 8. Click **Advanced** at the bottom of the dialog box to display the Advanced TCP/IP Settings dialog box.
 9. Click the **DNS** tab. Ensure no DNS server is administered. The address field should be blank.
 10. Click **OK**, **OK**, and **Close** to close all the windows.

Setting the browser options for Internet Explorer 6.0

A connection session to a media server might time out when connected through a proxy server. To avoid having the media server time out during a session, add the media server host names or IP addresses to the list of host names and IP addresses.

To set browser options for Internet Explorer 6.0:

1. In Internet Explorer 6.0, click **Tools > Internet Options**.
2. Select the **Connection** tab.
3. Click on **LAN settings**, then **Advanced**.
4. In the **Do not use proxy server for addresses beginning with** field, type the IP address for each media server you intend to access remotely.

If the IP addresses have the first or first and second octets the same, you can shorten the addresses to xxx.xxx.* (example, 135.9.*).

5. Click **OK** to close each dialog box.

Appendix B: Installation troubleshooting

This section provides some simple strategies to help you troubleshoot an installation of a media server. This section includes:

- [Troubleshooting the installation of the media server hardware](#) on page 97
- [Troubleshooting the configuration of the media server hardware](#) on page 98
- [Troubleshooting the installation of the license file and the Avaya authentication file](#) on page 100

Troubleshooting the installation of the media server hardware

Problem	Possible solution
No power to the UPS	<ul style="list-style-type: none">● Ensure that the UPS is plugged into the outlet.● Ensure that the outlet has power.● For other solutions, see the user guide for the UPS.
No power to the Ethernet switch	<ul style="list-style-type: none">● Ensure that the Ethernet switch is plugged into the UPS or the outlet.● Ensure that the UPS or outlet has power.● For other solutions, see the user guide for the Ethernet switch.
No power to the media server	<ul style="list-style-type: none">● Ensure that the media server is plugged into the UPS.● Ensure that the UPS has power.● Push the power button on the front of the media server.
The IPSI LEDs flash	<ul style="list-style-type: none">● Ensure that the IPSI is in the correct slot. Use slot 1 for the G650 Media Gateway, slot 2 for the G600 Media Gateway, and the Tone-Clock slot for all others.● Ping the IPSI from server.● Ping the server from the IPSI.

Troubleshooting the configuration of the media server hardware

Troubleshooting the configuration of the media server hardware

Problem	Possible solution
Cannot log in to the UPS subagent	<ul style="list-style-type: none"> ● Ensure that the SNMP subagent is installed in the UPS. ● Ensure that you are connected to the correct Ethernet port. ● Ensure that you have the correct login ID and password. For more information, see the user guide for the SNMP subagent. ● Ensure that the network card on the laptop computer is configured correctly.
Cannot log in to the Ethernet switch	<ul style="list-style-type: none"> ● Ensure that you are connected to the correct Ethernet port. (On the Ethernet switch, the correct port is labeled Console) ● Ensure that you have the correct login ID and password. See the user guide for the Ethernet switch. ● Ensure that the network card on the Services laptop computer is configured correctly.
Cannot log in to the media server	<ul style="list-style-type: none"> ● Check the link LED. If the LED is off, a cable or hardware problem exists. ● Ensure that you are connected to the Services Ethernet port. ● Ensure that you are using a cross-over cable between the Services laptop computer and the server. ● Ensure that the ARP cache is cleared on the Services laptop computer. In an MS-DOS window, type <code>arp -d 192.11.13.6</code> and press Enter. ● Ensure that you have connectivity. In an MS-DOS window, type <code>ping 192.11.13.6</code> and press Enter. ● Ensure that the NIC on the Services laptop computer is configured correctly.
Cannot access the Avaya Installation Wizard	<ul style="list-style-type: none"> ● Ensure that you are plugged into the Services port. ● Ensure that you are using the correct IP address, 192.11.13.6 ● Ensure that you are using the correct login and password. ● Ensure that the NIC on the laptop is configured correctly.
Cannot use SAT commands	<ul style="list-style-type: none"> ● Ensure that you are using the correct IP address, 192.11.13.6 and port 5023 ● Ensure that you are using the correct login and password.
1 of 2	

Troubleshooting the configuration of the media server hardware (continued)

Problem	Possible solution
Cannot ping out to the customer network	<ul style="list-style-type: none"> ● Ensure that in the LAN security settings “output from server” for icmp is enabled.
Cannot ping the media server from the customer network	<ul style="list-style-type: none"> ● Ensure that in the LAN security settings “input to server” for icmp is enabled.
Cannot access the media server remotely	<ul style="list-style-type: none"> ● Ensure that in the LAN security settings “input to server” is checked for SSH (Linux commands), https (Web access), and def-sat (SAT commands access). Change the LAN security settings on the Web interface with a direct connection to the media server.
The LED display on IPSI is flashing	<ul style="list-style-type: none"> ● The IPSI LED is not programmed with the switch and the location (DHCP) ● An IP address is not assigned to the IPSI LED (static IP addressing).
Cannot access the IPSI for static addressing	<ul style="list-style-type: none"> ● Ensure that you are plugged into the Services (top) port on the IPSI. ● Ensure that the ARP cache is cleared on the Services laptop computer. In an MS-DOS command window, type <code>arp -d 192.11.13.6</code> and press Enter.
No “V” shows on the IPSI LED	<ul style="list-style-type: none"> ● The IPSI is not connected to the Ethernet switch or the network. Connect a cable to the bottom port on the faceplate and to the Ethernet switch or the customer network. ● Make sure port on the Ethernet switch that is assigned to that IPSI is enabled.
The “V” on the IPSI LED is not filled in	<ul style="list-style-type: none"> ● An IP address is not assigned to the IPSI. ● The IPSI is not administered.
The system generates an alarm when first connect to IPSI	<ul style="list-style-type: none"> ● The IPSI does not have the current firmware. Upgrade the firmware.
2 of 2	

Troubleshooting the installation of the license file and the Avaya authentication file

Problem	Possible solution
Cannot get files from the RFA site	<ul style="list-style-type: none"> ● Provide the correct SAP number. ● Provide the serial number for the reference IPSI.
Cannot install the license file	<ul style="list-style-type: none"> ● Ensure that two license files do not exist on the server. If so, delete one of the files. ● The file might be corrupt. Download the file again from the RFA site. ● Use binary mode to upload the file.
The media server is in no-license mode	<ul style="list-style-type: none"> ● The license file does not have an IP address yet. This situation is normal when the license file is first installed because the file cannot see the IPSI. ● After 30 minutes, the license file has not located the reference IPSI. In a SAT session, type <code>reset system 1</code> and press Enter to reset the 30-minute clock.
Cannot use the administration commands	<ul style="list-style-type: none"> ● The media server might be in no license mode because the 30-minute timer lapsed. In a SAT session, type <code>reset system 1</code> and press Enter to reset the 30-minute clock.
ASG does not work	<ul style="list-style-type: none"> ● Re-install the Avaya authentication files.
Cannot install the authentication file	<ul style="list-style-type: none"> ● Administer a super-user login on the active server.

Index

A

access media server	
directly	89
remotely over modem	91
remotely over network	91
accessing Maintenance Web Interface	92
accessing the media server	36
add	
IP interface information	52
media gateways	50
administer	
IPSI circuit pack	54
AIW. See Avaya Installation Wizard	
alarm activation level	
setting	52
alarms	
enabling to INADS via SNMP	76
setting selected traps	30
to INADS by way of modem, enabling	75
viewing	72
ARP cache, clearing	35
Avaya Installation Wizard, using	41

B

backing up files to compact flash	75
---	--------------------

C

C363T or C364T Ethernet switch	
configuring	30
LEDs	81
security alert	30
clearing ARP cache	35
command line interface	93
Communication Manager	
installing software	35
compact flash, backing up to	75
configure	
Avaya C363T or C364T Ethernet switch	30
media server	39 , 49
modem	43
network interface card (NIC)	46
UPS	27
connect to customer network	19
connection to LAN, verifying	43

copy files to media server	40
customer network, connecting to	19

D

date and time, verifying	72
daylight savings rules	
location	71
setting	70
DHCP IP addressing	
IPSI circuit pack	54
using	59
diffserv parameters, setting	57
direct access to media server	89
disable unused Ethernet switch ports	73
disconnecting from media server	48

E

EMMC, installing	35 , 38
enable Ethernet switch ports	73
environmental specifications	
S8500	15
Ethernet switch	
configuring	32
default IP addresses	31
disabling unused ports	73
preparing to configure	31

F

faceplate	
TN2312BP circuit pack	83
firewall settings	44

I

INADS	
enabling alarms to by way of modem	75
inputting translations	49
installation	
troubleshooting	97
using the Wizard	41
installing	
Communication Manager software	37
translation file	52

Index

IP address	
set static	54
use DHCP	59
IP address, set static	54
IP interface	
enabling control	62
upgrading firmware version	62
verify translations	62
IP interface information	
adding to translations	52
IPSI	
connecting to	53
LEDs	83
program switch ID and cabinet.	54

L

LED	
additional information	80
LEDs	
Avaya Ethernet switches	81
IPSI	83
S8500 Media Server	78
UPS	82
license file, testing	77
license server, enabling on a media gateway	65
license, verifying status.	62
location	
setting for media gateways	71
login, super-user	40
LSP	
administer primary controller.	65
configuring S8500 as	63
installing the license	66
readminister media gateway controller list	68
resetting	67
S8500	24
S8500, opening TCP ports	67
S8500, verifying primary controller identifies	68
S8500, verifying translations.	68

M

Maintenance Web Interface, accessing	92
media gateway	
enabling license server on.	65
media gateways, adding	50
media server	
accessing	36
applying power	36
configuring	39, 49
copying files to	40
disconnecting from	48
LED, additional information	80
LEDs	78

media server, (continued)	
verify connectivity	61
verifying LAN connection.	43
modem	
access to media server	91
configuring	43
connect to media server	21
modem options, setting	22
modem, enabling alarms to INADS	75

N

network interface card (NIC)	
configuring	46
network time server (NTP), enabling	44

P

post installation tasks	76
power	
applying to media server	36
pre-installation tasks at the installation site	9
Processor Ethernet	22, 24
PuTTY, SSH client	87

R

remote access to media server	
over modem	91
over network	91

S

S8500	
control network components specifications	13
environmental specifications	15
features and specifications.	14
LEDs	78
LSP mode	24
LSP, opening the TCP ports	67
LSP, verifying translations	68
port connections.	19
saving translations	49, 52
set	
alarm activation level	52
daylight savings rules	70
selected traps (alarming).	30
static IP address	54
set static IP address	54
SNMP	
preparing to configure	28
SNMP modules	
administering	29
software, installing Communication Manager	37

spanning tree	
enabling	32
setting version	32
specifications	
S8500	14
S8500 control network components	13
SSH	
about	25
access with.	87
static IP addressing	
IPSI circuit pack	54
setting	54
static IP addressing, setting.	54
super-user login	40

T

TCP ports, opening on an S8500 LSP.	67
Telnet	
configuring for Win2000/XP	36
terminal emulation	93
testing	
license file	77
media server installation	77
TN2312BP	77
TN2312BP	
faceplate	83
LEDs	83
program switch ID and cabinet.	54
TN2312BP, testing.	77
translation file	
installing	52
translations	
inputting	49
IP interface.	49
saving	49 , 52
verifying	69
troubleshooting, media server installation	97

U

upgrading	
IP interface firmware version	62
UPS	
default IP addresses for S8400 and S8500	28
LEDs	82
security alert	27
SNMP module	27
UPS, configuring	27
using DHCP IP address.	59
using this documentation	8

V

verify	
connectivity to media servers.	61
date and time	72
IP interface translated	62
license status	62
media server connection to LAN	43
translations	69
view alarms	72
VLAN parameters, setting.	57

W

Wizard, installation	41
--------------------------------	--------------------

