



Backup Sensors Owner's Manual

MDX

Contents

Introduction	3
Important Information	4
How the Backup Sensors Work	5
Limitations	7
Operation	10
Daily Inspection	12
Care of the Backup Sensors	13
Troubleshooting	14

Thank you for purchasing this Acura accessory.

Please read this Owner's Manual carefully before using the backup sensors, and keep this manual in the glove box for future reference.

This product is designed to be used exclusively on a Acura MDX. Acura is not responsible if the unit is used for any other intended purpose.

This Owner's Manual should be considered a permanent part of the the vehicle. It should remain with the vehicle at all times and stay with the vehicle when sold.

This accessory should be installed only by a skilled technician who has the proper tools, equipment, and training to correctly and safely add equipment to your vehicle. Installation should not be attempted by "do-it-yourselfers."

This Owner's Manual contains important information about the safe operation of the backup sensors. We urge you to read this manual carefully, become familiar with the controls it describes, and follow its recommendations to help make your driving trouble-free and enjoyable.

Important Information

Before using the backup sensors, make sure you read and understand the operation and limitations of the system as discussed below and elsewhere in this manual.

- The backup sensors are designed to provide an audible sound when they detect large stationary objects while the vehicle is moving in reverse at low speed. However, the system may not detect all possible objects depending on their size, shape, or location.
- Even with the backup sensors, the driver is still responsible for making sure the path is clear when operating the vehicle in reverse.

How the Backup Sensors Work

Backup Sensors

The sensors are ready for operation when the shift lever is moved to the reverse position with the backup sensor switch turned ON.

Operation of the sensors is dependent upon the ultrasonic waves they emit. They calculate the distance between the sensor and a rear obstacle by measuring the time until the ultrasonic waves reach the sensor after being reflected by the obstacle.

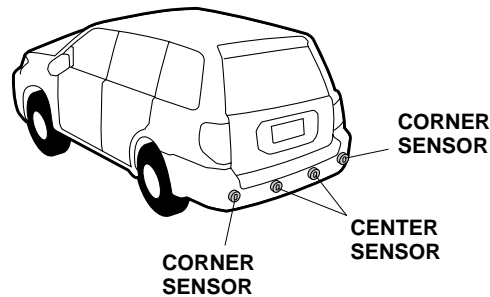

The sensors are designed to give you an audible signal when the rear bumper of your vehicle is approaching an obstacle.

- The audible signal has three sounds:

Sound (Tone Quality)	Corner Sensors (High)	Center Sensors (Low)
Slow intermittent beeps	Within 2 feet	Within 6 feet
Quick intermittent beeps	Within 1.5 feet	Within 4 feet
Continuous beep	Within 1 foot	Within 2 feet

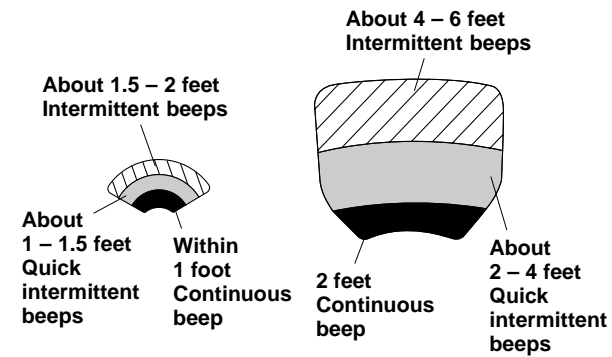

How the Backup Sensors Work

Corner Sensors:

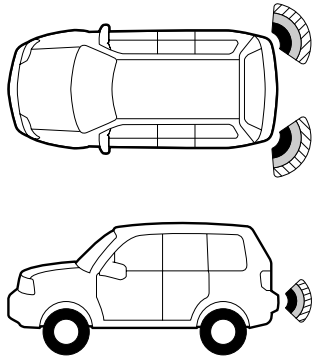

Center Sensors:

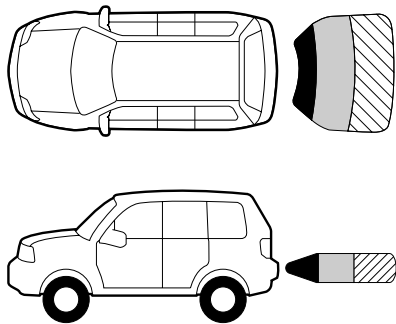

The sensors detect the closest rear obstacle.

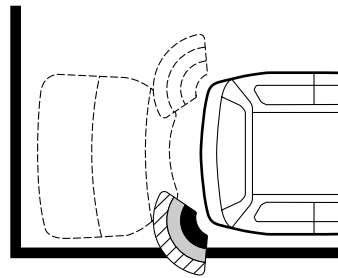

In this example, the corner sensor detects the side wall.

The sensors may not detect the rear bumper of tall vehicles.

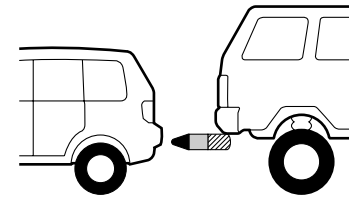

When towing a trailer, the audible signal may keep sounding if the shift lever is moved to the reverse position. When this occurs, turn the backup sensor switch OFF.

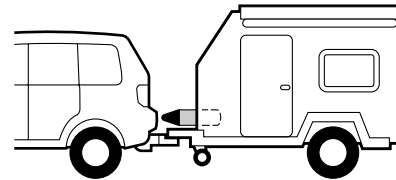

Limitations

The sensors detect only the closest obstacle. The sensors may detect other obstacles as the vehicle moves.

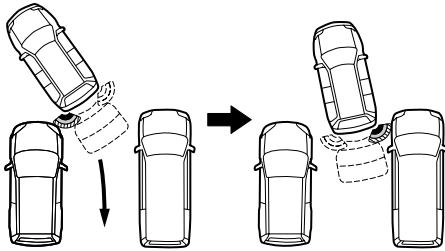

The sensors may not work if the ambient air temperature is below -4°F (-20°C) or above 122°F (50°C).

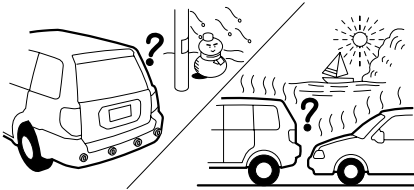

The sensors may not work if the obstacle is an odd shape or made of material that does not reflect ultrasonic waves.

Examples:

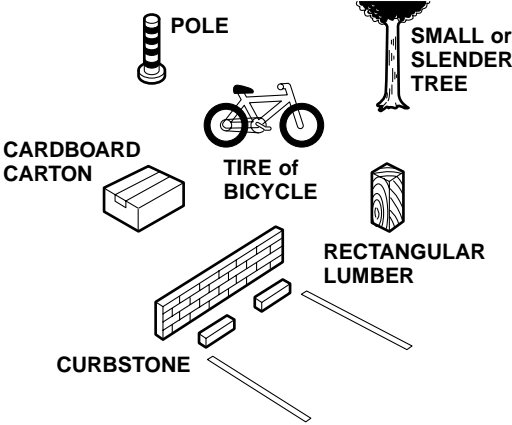

Limitations

The sensors may not sound for the following obstacles or under the following conditions:

- Piece of wire, rope, and net fence

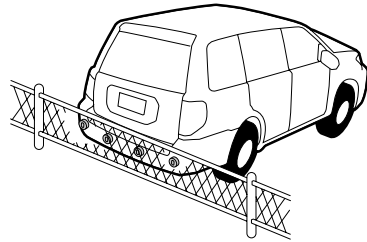

- Objects low in height such as curbstone, etc.

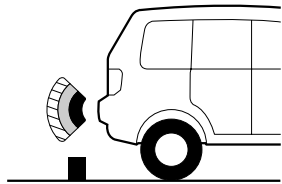

- Objects that absorb ultrasonic waves, such as soft snow, cotton and sponges

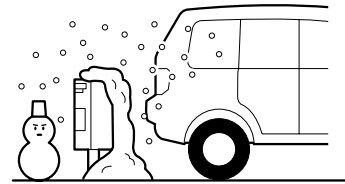

The audible signal may sound warning even if there is no obstacle behind the vehicle:

- Droplets of water frozen on the sensor

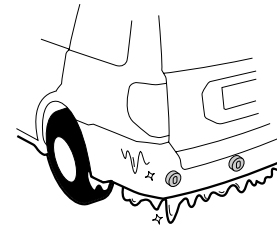

Limitations

The audible signal may sound warning even if there is no obstacle behind the vehicle:

- Sensors clogged with snow, dirt or mud

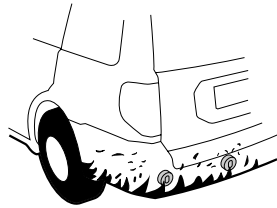

The sensors may sound continuously under the following conditions:

- When driving on rough surfaces or gravel roads or in grass, or when stopped on a hill

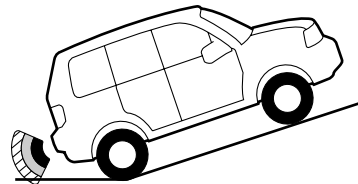

- When the vehicle is equipped with a high-power radio and antenna

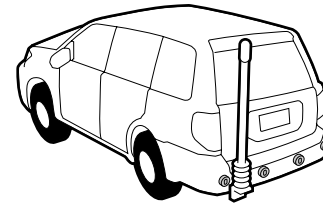

- When detecting loud noises such as a vehicle horn, a motorcycle's engine, or air brakes

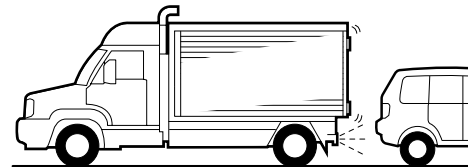

- When driving in rain or melted snow

Operation

Before using the backup sensors, become familiar with the types of sounds in relation to the distances between the sensors and the obstacle by actually backing your vehicle into a garage or parking space. Also confirm the obstacle detecting range of each backup sensor.

1. Check that the parking brake is applied.
2. Turn the ignition switch ON (II). Do not start the engine yet.

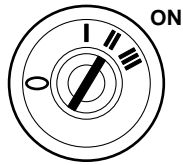

3. Turn the backup sensor switch ON.

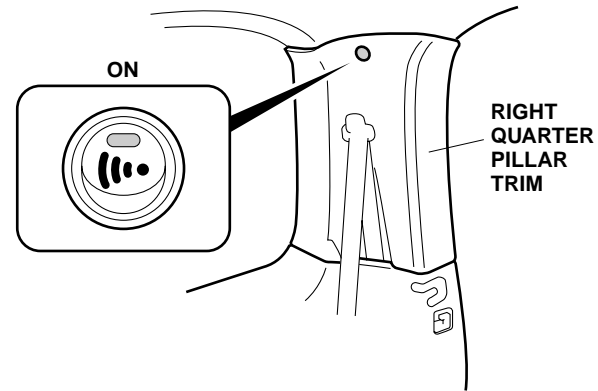

4. Move the shift lever to reverse.

Operation

5. From behind the vehicle, check that the audible signal sounds by slowly bringing the palm of your hand close to each sensor as described:

For the corner sensors: From 2 feet

For the center sensors: From 6 feet

Confirm that the sound of the corner sensors is different from that of the center sensors.

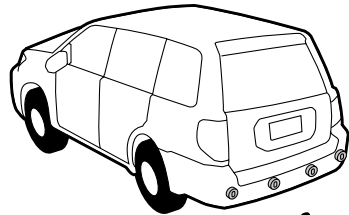

Confirm the obstacle detecting range of each sensor.



6. Check that the intermittent warning beeps become quicker as you bring the palm of your hand closer to the sensor.

For the corner sensors: About 1.5 feet

For the center sensors: About 4 feet

7. Check that the intermittent warning beeps are changed to a continuous beep as you bring the palm of your hand closer to the sensor. The sensor may stop sounding or sound intermittent beeps if you bring the palm of your hand closer too quickly.

For the corner sensors: About 1 foot

For the center sensors: About 2 feet

8. Turn the ignition switch to the LOCK "0" position.

Daily Inspection

1. Start the engine.
2. Apply the parking brake, and depress the brake pedal. Move the shift lever to the reverse position. Check that the audible signal sounds for about one second.
 - The sensors are normal if the audible signal sounds for about one second.
 - If the audible signal keeps sounding, this is an indication that the sensors are frozen or clogged with mud, dirt, etc.
 - The sensors will also keep sounding when there is an abnormality in the circuit.

Care of the Backup Sensors

Wipe the sensors clean with a clean cloth, or flush with low-pressure water when the sensors are clogged with mud and dirt.

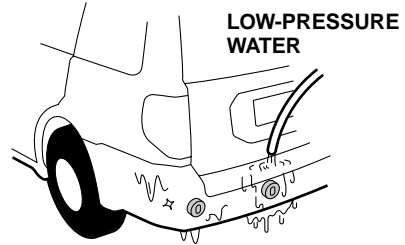

Do not direct high-pressure water against the sensors.

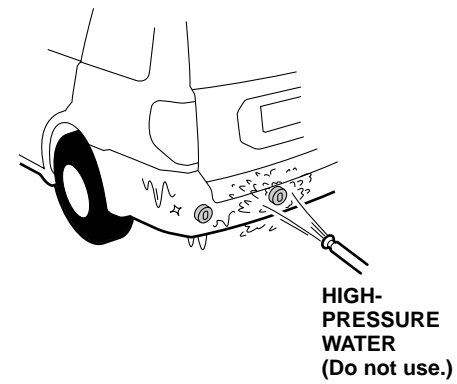

Troubleshooting

Perform the following checks if the audible signal does not sound when the vehicle is approaching an obstacle.

Symptom	Remedy
• Clogged sensor with snow or mud	• Wipe with clean cloth or flush with low-pressure water.
• Frozen sensor	• Melt with lukewarm water
• Extended parking in cold weather or under blazing sun	• The backup sensors may not work if the outside air temperature is below -4°F (-20°C) or above 122°F (50°C).

Ask your Acura dealer for advice if the trouble persists.

Take your vehicle to your Acura dealer if you encounter either of these problems:

- The audible signal sounds continuously when the shift lever is in the reverse position, and the sensors are not frozen or clogged with snow or mud.
- The audible signal does not sound when the shift lever is in the reverse position and the backup sensor switch is turned ON.

Troubleshooting With Beeps

Corner Sensors

Series of two intermittent beeps: right sensor is faulty.

Series of three intermittent beeps: left sensor is faulty.

Series of four intermittent beeps: right and left sensors are faulty.

Center Sensors

Series of three beeps: either or both sensors are faulty.

Be careful not to confuse the sound of the sensors with those of other components or systems.

ACURA