



website <http://www.lgservice.com>  
e-mail <http://www.lgservice.com/techsup.html>

# LG

## Window-Type Air Conditioner

### ***OWNER'S MANUAL***

LG

ENGLISH

ESPAÑOL

***MODELS, MODELOS: LWHD1000CR***

#### **IMPORTANT**

Please read through this manual. It contains valuable information about your air conditioner. This manual may help save time and money by explaining proper air conditioner maintenance and preventing improper use.

#### **PRECAUTIONS**

Pay close attention to precautions in order to prevent potential hazards and damage from misuse or improper installation. LG is not responsible for any damages caused by misuse of the air conditioner.

# TABLE OF CONTENTS

Safety Precautions .....	3
Prior to Operation .....	7
Introduction .....	8
Electrical Safety .....	9
Installation .....	11
Operating Instructions .....	16
Maintenance and Service .....	19



## FOR YOUR RECORDS

Write the model and serial numbers here:

**Model #** \_\_\_\_\_

**Serial #** \_\_\_\_\_

You can find them on a label on the side of each unit.

**Dealer's Name** \_\_\_\_\_

**Date Purchased** \_\_\_\_\_

■ Staple your receipt to this page in the event you need it to prove date of purchase or for warranty issues.



## READ THIS MANUAL

Inside you will find many helpful hints on how to use and maintain your air conditioner properly. Just a little preventive care on your part can save you a great deal of time and money over the life of your air conditioner.

You'll find many answers to common problems in the chart of troubleshooting tips. If you review our chart of

**Troubleshooting Tips** first, you may not need to call for service at all.



## PRECAUTION

- Contact the authorized service technician for repair or maintenance of this unit.
- Contact the installer for installation of this unit.
- The air conditioner is not intended for use by young children or invalids without supervision.
- Young children should be supervised to ensure that they do not play with the air conditioner.
- When the power cord is to be replaced, replacement work shall be performed by authorized personnel only using only genuine replacement parts.
- Installation work must be performed in accordance with the National Electric Code by qualified and authorized personnel only.

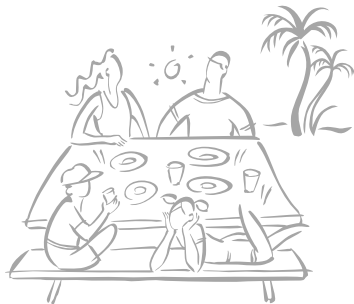

# Safety Precautions



To prevent injury to the user or other people and property damage, the following instructions must be followed.

■ Incorrect operation due to ignoring instruction will cause harm or damage. The seriousness is classified by the following indications.

**⚠ WARNING** This symbol indicates the possibility of death or serious injury.

**⚠ CAUTION** This symbol indicates the possibility of injury or damage to properties only.

■ Meanings of symbols used in this manual are as shown below.

	<b>Be sure not to do.</b>
	<b>Be sure to follow the instruction.</b>

## ⚠ WARNING

### ■ Installation

**Don't use a power cord, a plug or a loose socket which is damaged.**

- Otherwise, it may cause a fire or electrical shock.

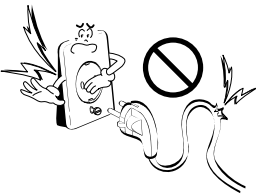

**Always plug into a grounded outlet.**

- Otherwise, it may cause a fire or electrical shock.

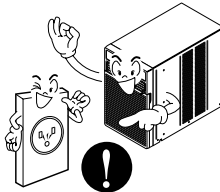

**Do not modify or extend the power cord length.**

- It will cause electric shock or fire due to heat generation.

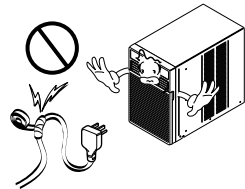

**Do not disassemble or modify products.**

- It may cause failure and electric shock.



**Be caution when unpacking and installing.**

- Sharp edges may cause injury.



**Do not use the power cord near flammable gas or combustibles such as gasoline, benzene, thinner, etc.**

- It may cause explosion or fire.

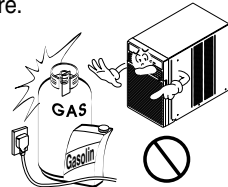

## ■ Operation

**Do not place heavy object on the power cord and take care so that the cord should not be pressed.**

- There is danger of fire or electric shock.

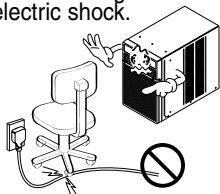

**Do not share the outlet with other appliances.**

- It will cause electric shock or fire due to heat generation.

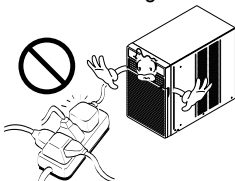

**Take the power plug out if necessary, holding the head of the plug and do not touch it with wet hands.**

- Otherwise, it may cause a fire or electrical shock.



**Do not place the power cord near a heater.**

- It may cause fire and electric shock.

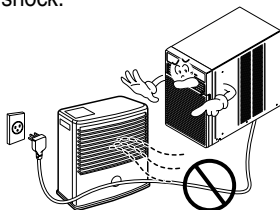

**Do not allow water to run into electric parts.**

- It will cause failure of machine or electric shock.

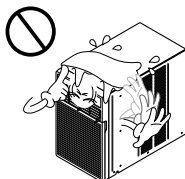

**Use a soft cloth to clean. Do not use wax, thinner, or a strong detergent.**

- The appearance of the air conditioner may deteriorate, change color, or develop surface flaws.



**Unplug the unit if strange sounds, odors, or smoke come from it.**

- Otherwise it may cause fire and electric shock accident.



**Do not open the suction inlet grill of the product during operation.**

- Otherwise, it may electrical shock and failure.



**If water enters the product, turn off the power switch of the main body of appliance. Contact service center after taking the power-plug out from the socket.**



**Ventilate the room well when using this appliance together with a stove, etc.**

- An oxygen shortage may occur.

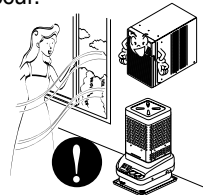

**Turn off the power and breaker firstly when cleansing the unit.**

- Since the fan rotates at high speed during operation, it may cause injury.



**Turn off the main power switch when not using it for a long time.**

- Prevent accidental startup and the possibility of injury.



**Do not operate or stop the unit by inserting or pulling out the power plug.**

- It will cause electric shock or fire due to heat generation.

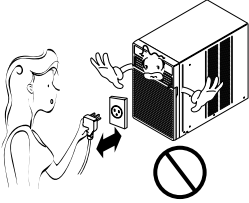

**Do not damage or use an unspecified power cord.**

- It will cause electric shock or fire.

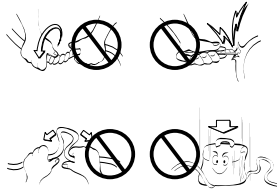

**Do not operate with wet hands or in damp environment.**

- It will cause electric shock.

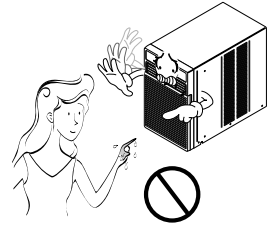

**Hold the plug by the head when taking it out.**

- It may cause electric shock and damage.

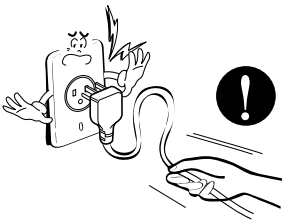

**When gas leaks, open the window for ventilation before operating the unit.**

- Otherwise, it may cause explosion, and a fire.



**Never touch the metal parts of the unit when removing the filter.**

- They are sharp and may cause injury.

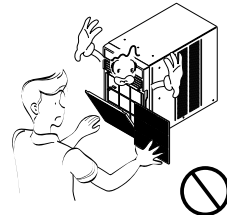

**⚠ CAUTION**

## ■ Installation

**Install the product so that the noise or hot wind from the outdoor unit may not cause any damage to the neighbors.**

- Otherwise, it may cause dispute with the neighbors.

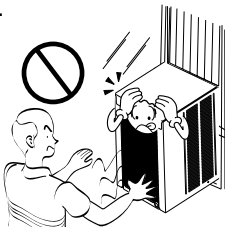

**Keep level parallel in installing the product.**

- Otherwise, it may cause vibration or water leakage.

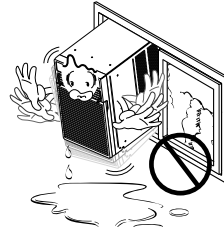

## ■ Operation

**Do not put a pet or house plant where it will be exposed to direct air flow.**

- It may cause injury.

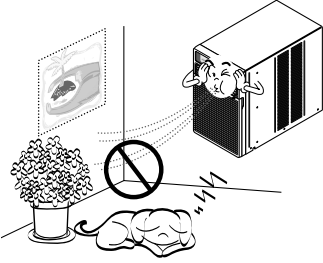

**Do not block the inlet or outlet of air flow.**

- It may cause product failure.

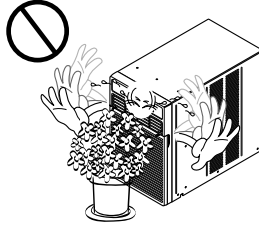

**Use a soft cloth to clean. Do not use wax, thinner, or a strong detergent.**

- The appearance of the air conditioner may deteriorate, change color, or develop surface flaws.

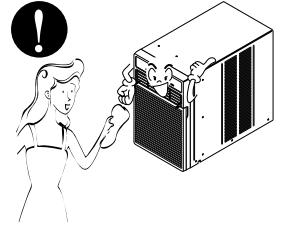

**Do not step on the indoor/outdoor unit and do not put anything on it.**

- It may cause an injury through dropping of the unit or falling down.



**Always insert the filter securely. Clean it every two weeks.**

- Operation without filters will cause failure.



**Do not drink water drained from air conditioner.**

- It contains contaminants and will make you sick.



**Be cautious not to touch the sharp edges when installing.**

- It may cause injury.

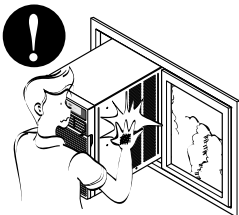

**Avoid excessive cooling and perform ventilation sometimes.**

- Otherwise, it may do harm to your health.

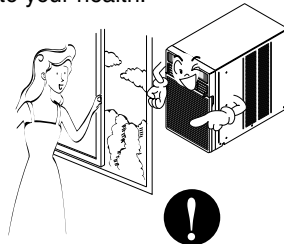

**Do not insert the hands or bars through the air inlet or outlet during operation.**

- Otherwise, it may cause personal injury.

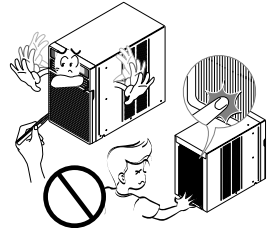

# Prior to Operation

## *Preparing for Operation*

1. Contact an installation specialist for installation.
2. Plug in the power plug properly.
3. Use a dedicated circuit.
4. Do not use an extension cord.
5. Do not start/stop operation by plugging/unplugging the power cord.
6. If the cord/plug is damaged, replace it with only an authorized replacement part.

## *Usage*

1. Being exposed to direct airflow for an extended period of time could be hazardous to your health. Do not expose occupants, pets, or plants to direct airflow for extended periods of time.
2. Due to the possibility of oxygen deficiency, ventilate the room when used together with stoves or other heating devices.
3. Do not use this air conditioner for non-specified special purposes (e.g. preserving precision devices, food, pets, plants, and art objects). Such usage could damage the items.

## *Cleaning and Maintenance*

1. Do not touch the metal parts of the unit when removing the filter. Injuries can occur when handling sharp metal edges.
2. Do not use water to clean inside the air conditioner. Exposure to water can destroy the insulation, leading to possible electric shock.
3. When cleaning the unit, first make sure that the power and breaker are turned off. The fan rotates at a very high speed during operation. There is a possibility of injury if the unit's power is accidentally triggered on while cleaning inner parts of the unit.

## *Service*

For repair and maintenance, contact your authorized service dealer.

# Introduction

## Symbols Used in this Manual



This symbol alerts you to the risk of electric shock.



This symbol alerts you to hazards that could cause harm to the air conditioner.

### **NOTICE**

This symbol indicates special notes.

## Features

### **⚠ WARNING**

This appliance should be installed in accordance with the National Electric Code.

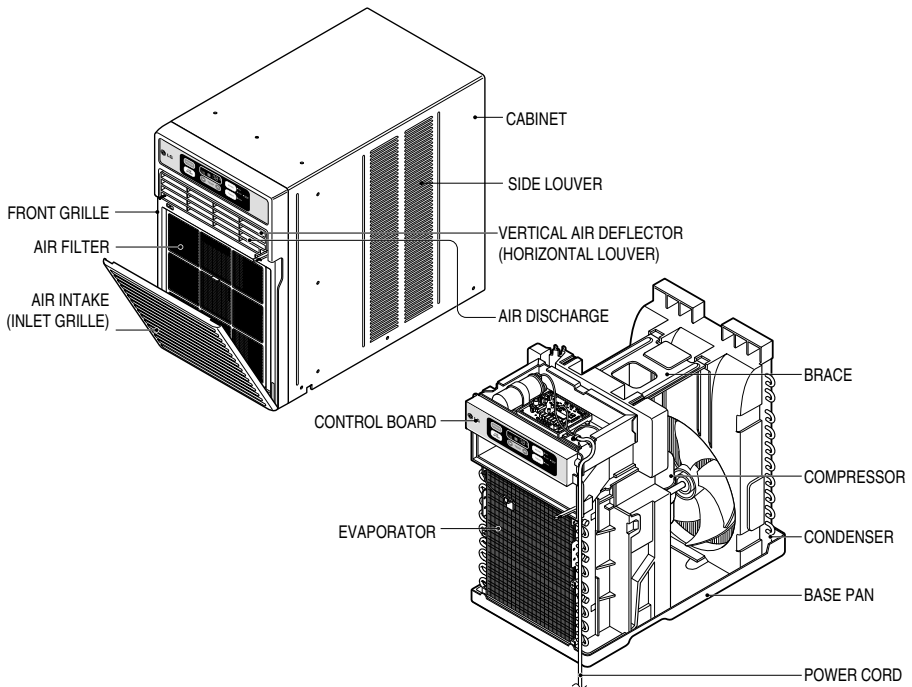



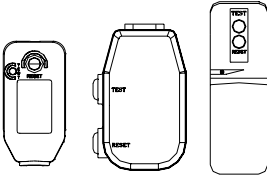
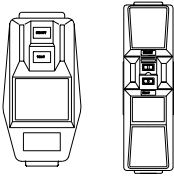

# Electrical Safety

## Electrical Data

115V~	230V~	
		<p>Power cord may include a current interrupter device. A test and reset button is provided on the plug case. The device should be tested on a periodic basis by first pressing the TEST button and then the RESET button. If the TEST button does not trip or if the RESET button will not stay engaged, discontinue use of the air conditioner and contact a qualified service technician.</p>

### NOTICE

The shape may be different according to its model.

Use Wall Receptacle	Power Supply
 <p>Standard 125V, 3-wire grounding receptacle rated 15A, 125V AC</p>	<p>Use 15 AMP. time delay fuse or 15 AMP. circuit breaker.</p>
 <p>Standard 250V, 3-wire grounding receptacle rated 15A, 250V AC</p>	
 <p>Standard 250V, 3-wire grounding receptacle rated 20A, 250V AC</p>	<p>Use 20 AMP. time delay fuse or 20 AMP. circuit breaker.</p>

### Use of extension cords

Because of potential safety hazards, we strongly discourage the use of an extension cord. However, if you wish to use an extension cord, use a CSA certified/UL-listed 3-wire (grounding) extension cord, rated 15A, 125V.

All wiring should be made in accordance with local electrical codes and regulations.

### NOTICE

Aluminum house wiring may pose special problems. Consult a qualified electrician.

## ELECTRICAL SAFETY

### IMPORTANT GROUNDING INSTRUCTIONS

Air conditioner has a three-prong grounding plug on its power supply cord, which must be plugged into properly grounded three-prong wall receptacle for your protection against possible shock hazard.

### 230, 208, and 230/208 VOLT UNITS

These units are equipped with a three-prong grounding plug on the power supply cord, which must be plugged into a matching properly grounded three-prong wall receptacle for your protection against possible shock hazard. If such an outlet is

not present, one must be installed by a qualified electrician in accordance with the National Electrical Code and local codes and ordinances.

### NOTICE

DO NOT USE AN EXTENSION CORD on 230, 208, and 230/208 Volt units.

## Electrical Safety

### **IMPORTANT (PLEASE READ CAREFULLY)**

#### **FOR THE USER'S PERSONAL SAFETY, THIS APPLIANCE MUST BE PROPERLY GROUNDED**

The power cord of this appliance is equipped with a three-prong (grounding) plug. Use this with a standard three-slot (grounding) wall power outlet to minimize the hazard of electric shock. The customer should have the wall receptacle and circuit checked by a qualified electrician to make sure the receptacle is properly grounded.

#### **DO NOT CUT OR REMOVE THE THIRD (GROUND) PRONG FROM THE POWER PLUG.**

### **A. SITUATIONS WHEN THE APPLIANCE WILL BE DISCONNECTED OCCASIONALLY:**

Because of potential safety hazards, we strongly discourage the use of an adapter plug. However, if you wish to use an adapter, a TEMPORARY CONNECTION may be made. Use UL-listed adapter, available from most local hardware stores.

The large slot in the adapter must be aligned with the large slot in the receptacle to assure a proper polarity connection.

### **▲ CAUTION**

**: Attaching the adapter ground terminal to the wall receptacle cover screw does not ground the appliance unless the cover screw is metal, and not insulated, and the wall receptacle is grounded through the house wiring. The customer should have the circuit checked by a qualified electrician to make sure the receptacle is properly grounded.**

Disconnect the power cord from the adapter, using one hand on each. Otherwise, the adapter ground terminal might break. DO NOT USE the appliance with a broken adapter plug.

### **B. SITUATIONS WHEN THE APPLIANCE WILL BE DISCONNECTED OFTEN.**

Do not use an adapter plug in these situations. Unplugging the power cord frequently can lead to an eventual breakage of the ground terminal. The wall power outlet should be replaced by a three-slot (grounding) outlet instead.

### **USE OF EXTENSION CORDS**

Because of potential safety hazards, we strongly discourage the use of an extension cord. However, if you wish to use an extension cord, use a CSA certified/UL-listed 3-wire (grounding) extension cord, rated at 15A, 125V.

# Installation

## Installation Kits Contents

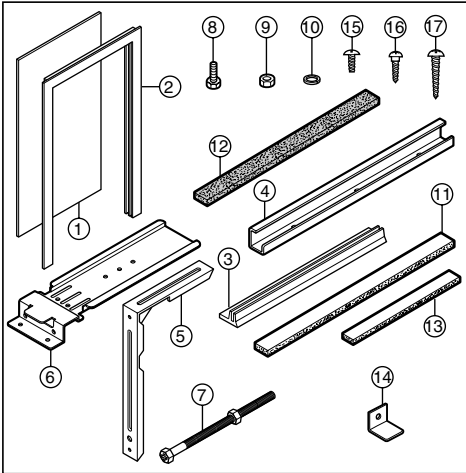

NO.	NAME OF PARTS	QTY
1	Curtain	1
2	Curtain Frame	1
3	Upper Guide	1
4	Side Guide	2
5	Support Bracket	1
6	Bracket	1
7	Leveling Bolt & Nut	1
8	Bolt	2
9	Nut	2
10	Washer	2
11	Side Guide seal	1
12	Foam Seal Strip	1
13	Window Track Seal	1
14	Window Locking Bracket	1
15	Screw (Type A)	9
16	Screw (Type B)	3
17	Screw (Type C)	8

## Window Requirements

1. These instructions are for a horizontal sliding window or a casement window.
2. The electrical outlet must be within reach of the power cord.

For installation in a casement window, the window frame assembly and the side of the building must be adequate to support the weight of the air conditioner.

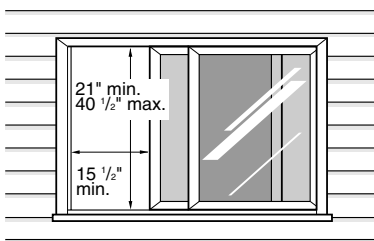

Horizontal sliding window

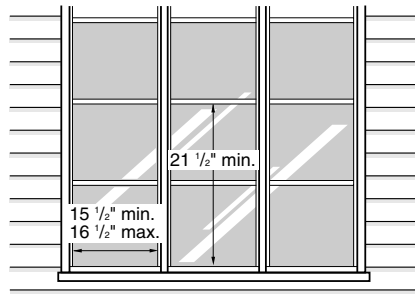

Casement window

## How to Install the Unit

1. To prevent vibration and noise, make sure the unit is installed securely and firmly
2. Install the unit where the sunlight does not shine directly on the unit.
3. The outside of the cabinet must extend outward for at least 14" and there should be no obstacles, such as a fence or wall, within 20" from the back of the cabinet because it will prevent heat radiation of the condenser. Restriction of outside air will greatly reduce the cooling efficiency of the air conditioner.

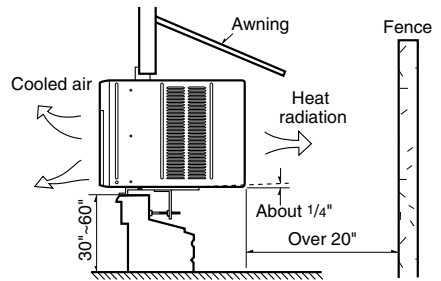

### NOTICE

All side louvers of the cabinet must remain exposed to the outside of the structure.

4. Install the unit at a slight incline so the back is slightly lower than the front (about 1/4"). This will force condensed water to flow to the outside.
5. Install the unit with the bottom about 30"~60" above the floor level.

## Installing the Power cord

You can choose between the two methods below according to your preference and window sill shape.

### Using slit "A"

- Fasten the stopper using Type A screw, and pass the power cord through slit "A".

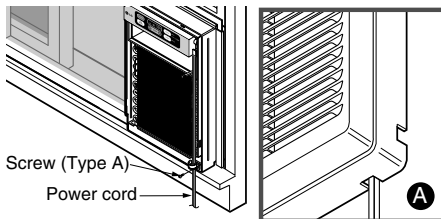

### Using slit "B"

- Fasten the stopper using left screw hole, and rotate properly to pass the power cord through slit "B".

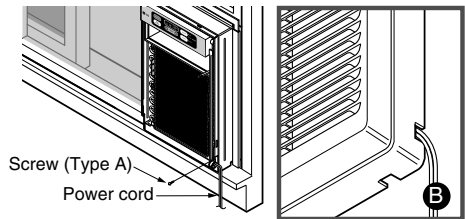

## Horizontal Sliding Window Installation

1. Loosely attach the Support Bracket to the bottom of Bracket using Bolts, Washer, and Nuts. Attach the Leveling Bolt and Nut. (Fig. 1)

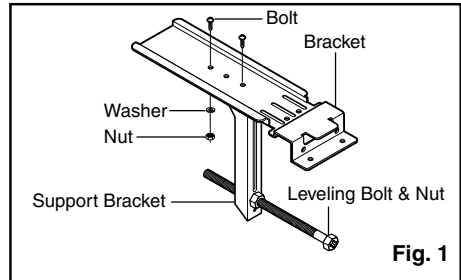

2. Remove protective backing from Window Track Seal and apply seal to window track. (Fig.2)

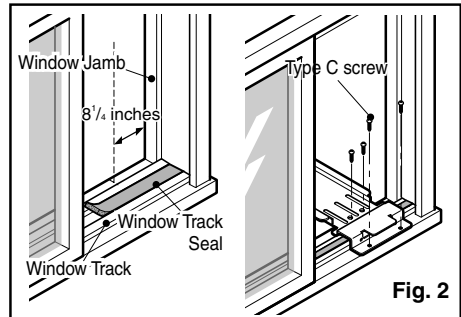

3. Measure and lightly mark a line 8-1/4 inches from window jamb. Center the Support Bracket assembly on the window track and fasten with 4 Type C screws. (Fig. 2)

4. Put the Support Bracket against the outside wall and tighten the Bolts on top of the Bracket. Adjust the Leveling Bolt so that the air conditioner will be installed with a very slight tilt (about 1/4") downward toward the outside for proper drainage. Tighten the nut. (Fig. 3)

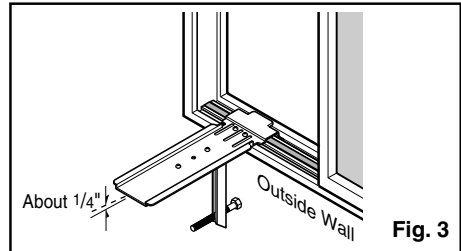

### NOTICE

DO NOT drill a hole in the bottom of the base pan. The air conditioner is designed to operate with the bottom of the base pan approximately half-full of water.

5. Fasten Side Guides to the sides of the Air Conditioner using 3 Type A screws per Guide. Start with first screw at middle of Guide. (Fig. 4)
6. Fasten Upper Guide on the top of the Air Conditioner using 3 Type A screws. (Fig. 4)

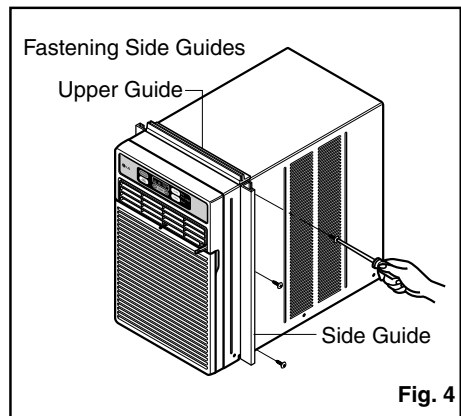

7. Measure height of window opening from top of Bracket assembly as shown Fig. 5. Subtract 20-3/4 inches. Mark this measurement on Curtain and cut the Curtain. (Fig. 5)

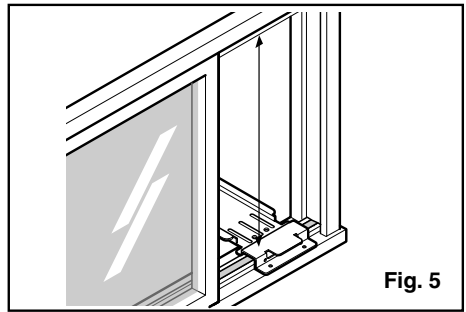

8. Slide Curtain into Curtain Frame. Slide Curtain Frame assembly into side Guides of the Air Conditioner cabinet. Make sure Curtain is firmly enclosed on all sides by the Frame. (Fig. 6)

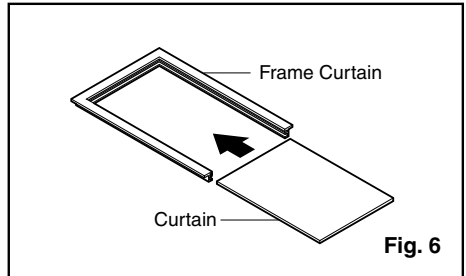

9. Cut side Guide seal into 2 equal lengths. Remove protective backing and apply it to the rear side of cabinet Side Guides, starting just below Curtain Frame assembly. Pinch off excess length so seal is even with the bottom of side Guide. (Fig. 7)

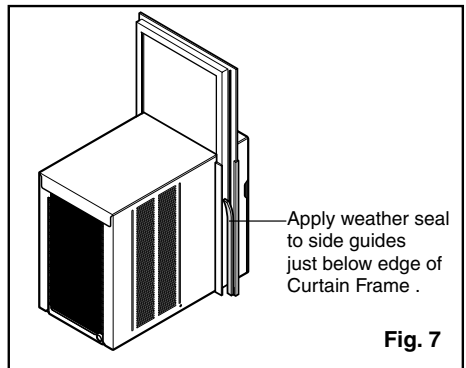

10. Place Air Conditioner in window opening. It should sit on Bracket assembly so that Curtain Frame and cabinet Side Guides are against top and side window jambs. Mate front of Bracket with Base Guide attached to the bottom of base pan.

11. Drill 1/8 inch holes in window track through the existing holes on Base Guide. Screw 4 Type C screws through the holes. (Fig. 8)

12. If this is a casement window installation, proceed to Casement Window Installation. If not, slide inner window sash firmly against side of the cabinet.

13. Drill 1/8 inch hole in window jamb to align with the existing holes in the Curtain Frame. Attach Curtain Frame to window frame with 2 Type B screws. (Fig. 8)

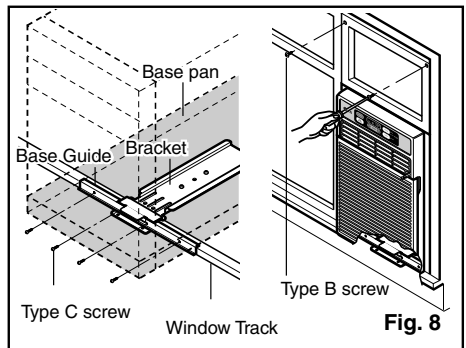

**NOTICE**

Check all seals and plug any remaining air gaps with a suitable weatherproof caulk.

14. If this is a casement window installation, proceed to Casement Window Installation. If not, stuff the Foam Seal Strip between the vertical sash and the window glass. (Fig. 9)
15. Attach the L Bracket with a Type B screw. (Fig. 9)

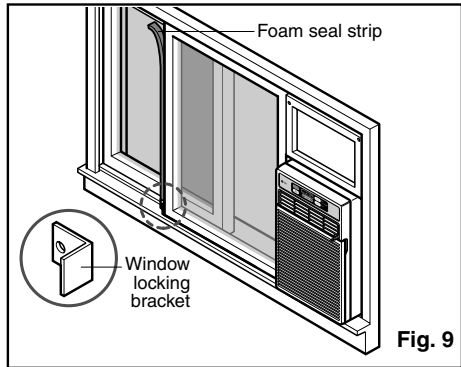
**Fig. 9****Casement Window Installation**

1. Installation procedure is the same as that described in steps 1 through 11 and step 13 of the Horizontal Sliding Window installation.
2. If the window opening is wider than 15-3/4 inches you will need to install a filler panel. Make this panel from 3/4 inch thick wood and run it the full length of the window. Attach it securely to the window frame and paint it to protect it from the weather.
3. Since styles and sizes of casement windows vary widely, it is advisable to have the air conditioner installed by someone skilled in this type of installation.

# Operating Instructions

## Controls

The remote control and control panel will look like those represented in the following pictures.

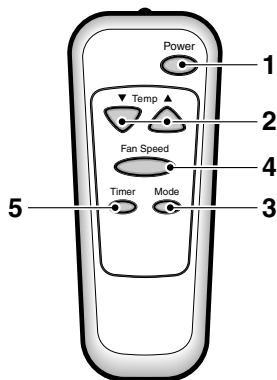
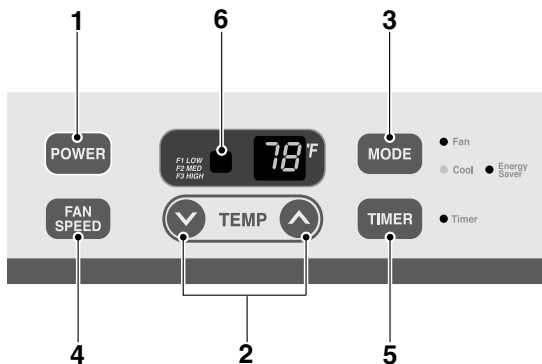

## Remote Control Operations

### 1. POWER

- To turn the air conditioner ON, push this button. To turn the air conditioner OFF, push the button again.
- This button takes priority over any other button.
- When you first turn it on, the unit is in cool mode, high fan speed, temperature setting at 72°F.

### 2. TEMPERATURE SETTING

- Use this button to automatically control the temperature of the room. The temperature can be set within a range of 60°F to 86°F by increments of 1°F.

### 3. MODE

- Every time you push this button, it will cycle through the following modes: COOL, ENERGY SAVER and FAN.
- ENERGY SAVER
  - The fan stops when the compressor stops cooling. Approximately every 3 minutes the fan will turn on and the unit will check the room air to determine if cooling is needed.

### 4. FAN SPEED

- Every time you push this button, it advances the setting as follows: {High(F3) → Low(F1) → Med(F2) → High(F3)}

### 5. TIMER

- SHUT-OFF TIME
  - You will usually use shut-off time while you sleep.
  - With unit running, use Timer to set number of hours until shut-off.
  - For your sleeping comfort, once Time is set, the Temperature setting will raise 2°F after 30 min, and 2°F after another 30 min.
  - Every time you push Timer button, it advances the Timer setting as follows: 1 Hour → 2 Hours → etc. → 12 Hours maximum.
- START TIME
  - With unit not running, use timer to set number of hours before unit starts.
  - Every time you push Timer button, it advances the Timer setting as follows: 1 Hour → 2 Hours → etc. → 12 Hours maximum.

### 6. REMOTE CONTROL SENSOR

#### AUTO RESTART

When power is restored after an electrical power failure, the unit will begin to run at its last setting.



## Inserting the Remote Control Batteries

1. Push out the cover on the back of the remote control with your thumb.
2. Pay attention to polarity and insert two new AAA 1.5V batteries.
3. Reattach the cover.

### NOTICE

Do not use rechargeable batteries. Make sure that both batteries are new. Do not mix alkaline, standard(Carbon-zinc) or rechargeable(Nickel-cadmium) batteries.

- In order to prevent discharge, remove the batteries from the remote control if the air conditioner is not going to be used for an extended period of time. Keep the remote control away from extremely hot or humid places. To maintain optimal operation of the remote control, the remote sensor should not be exposed to direct sunlight.

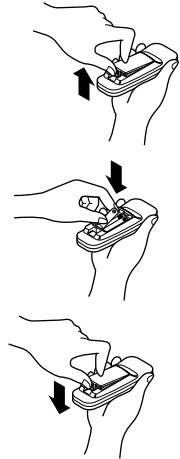

## Additional Features

Additional controls and important information.

### Ventilation

The ventilation lever must be in the CLOSE position in order to maintain the best cooling conditions.

When fresh air is necessary in the room, set the ventilation lever to the OPEN position.

When the damper is opened and room air is exchanged with external air.

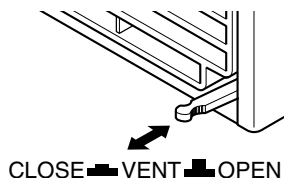

### Air Direction

The direction of air can be controlled wherever you want to cool by adjusting the horizontal louver and the vertical louver.

#### • HORIZONTAL AIR-DIRECTION CONTROL

The horizontal air direction is adjusted by rotating the vertical louver right or left.

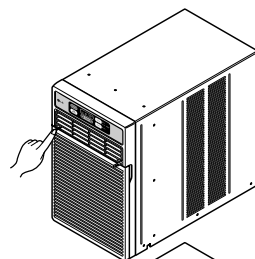

#### • VERTICAL AIR-DIRECTION CONTROL

The vertical air direction is adjusted by rotating the horizontal louver forward or backward.

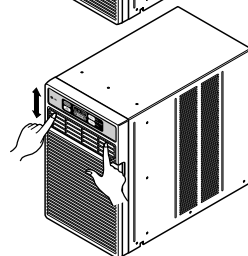

### How to Secure the Drain Pipe

In humid weather, excess water may cause the BASE PAN to overflow and be splashed on the side louver. To drain the water, remove the DRAIN CAP and secure the DRAIN PIPE to the rear hole of the BASE PAN.

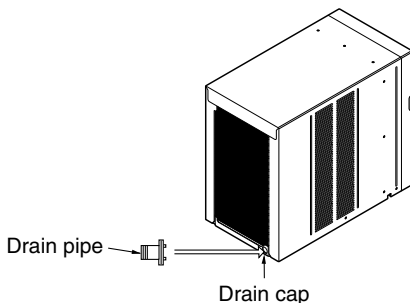

# Maintenance and Service

TURN THE AIR CONDITIONER OFF AND REMOVE THE PLUG FROM THE POWER OUTLET.

## Air Filter Cleaning

The air filter behind the front grille should be checked and cleaned at least once every 2 weeks or more often if necessary.

### To remove:

1. Open the inlet grille downward by pulling out the top of the inlet grille.
2. Remove the air filter from the front grille assembly by pulling the air filter up slightly.
3. Clean the filter with warm, soapy water below 40°C (104°F).
4. Rinse and gently shake the water from the filter and let it dry before replacing it.

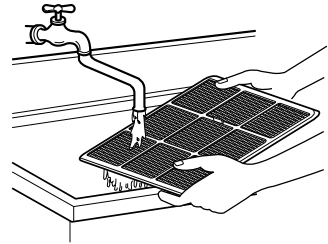
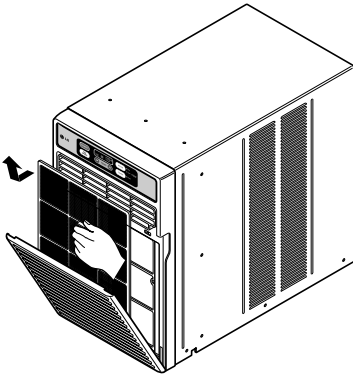

### ⚠ CAUTION

DO NOT operate the air conditioner without a filter because dirt and lint will clog it and reduce performance.

### NOTE!

Before using the air conditioner secure the front grille with two screws enclosed with the owner's manual.

1. Open the inlet grille downward and remove the air filter.
2. Fasten the front grille with screws.
3. Reinstall the air filter.
4. Close the inlet grille.

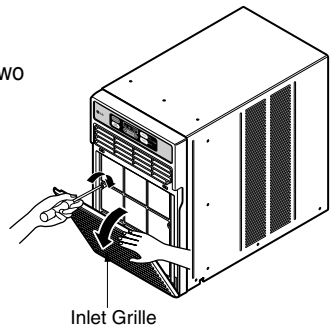

## Common Problems and Solutions

### Before calling for service

If you have problems with your air conditioner, read the following information and try to solve the problem. If you cannot find a solution, turn off the air conditioner and contact your dealer.

#### **Air conditioner does not operate**

1. Ensure that the air conditioner is plugged into a proper outlet.
2. Check the fuse or circuit breaker.
3. Check whether the voltage is unusually high or low.

#### **Air does not feel cold enough on the cooling setting**

1. Ensure that the temperature settings are correct.
2. Check to see if the air filter is clogged with dust. If so, replace the filter.
3. Ensure that the air flow from the outside is not obstructed and that there is a clearance of over 20" between the back of the air conditioner and the wall or fence behind it.
4. Close all doors and windows and check for any source of heat in the room.



Before calling for service, please review the following list of common problems and solutions.

#### ***The air conditioner is operating normally when:***

- You hear a pinging noise. This is caused by water being picked up by the fan on rainy days or in highly humid conditions. This feature is designed to help remove moisture in the air and improve cooling efficiency.
- You hear the thermostat click. This is caused by the compressor cycle starting and stopping.
- You see water dripping from the rear of the unit. Water may be collected in the base pan in highly humid conditions or on rainy days. This water overflows and drips from the rear of the unit.
- You hear the fan running while the compressor is silent. This is a normal operational feature.

## Troubleshooting

### The air conditioner may be operating abnormally when:

Problem	Possible Causes	What To Do
The air conditioner does not operate at all	<ul style="list-style-type: none"> <li>■ The air conditioner is unplugged or not plugged in completely.</li> </ul>	<ul style="list-style-type: none"> <li>• Make sure the plug is completely plugged into the outlet.</li> </ul>
	<ul style="list-style-type: none"> <li>■ The fuse is blown/circuit breaker is triggered.</li> </ul>	<ul style="list-style-type: none"> <li>• Check the fuse/circuit breaker box and replace the fuse or reset the breaker.</li> </ul>
	<ul style="list-style-type: none"> <li>■ Power failure.</li> </ul>	<ul style="list-style-type: none"> <li>• In the event of a power failure, set the power control to OFF. When the power is restored, wait 3 minutes to restart the air conditioner to prevent the compressor from overloading.</li> </ul>
	<ul style="list-style-type: none"> <li>■ The current interrupter device is tripped.</li> </ul>	<ul style="list-style-type: none"> <li>• Press the RESET button located on the power cord plug. If the RESET button will not stay engaged, discontinue use of the air conditioner and contact a qualified service technician.</li> </ul>
Air conditioner does not cool	<ul style="list-style-type: none"> <li>■ Air flow is restricted.</li> </ul>	<ul style="list-style-type: none"> <li>• Make sure there are no curtains, blinds, furniture or other obstacles in front of the air conditioner.</li> </ul>
	<ul style="list-style-type: none"> <li>■ TEMP Control set too higher number.</li> </ul>	<ul style="list-style-type: none"> <li>• Set the TEMP control to a lower number.</li> </ul>
	<ul style="list-style-type: none"> <li>■ The air filter is dirty.</li> </ul>	<ul style="list-style-type: none"> <li>• Clean the filter at least every 2 weeks. Refer to the "Maintenance and Service" section of the manual.</li> </ul>
	<ul style="list-style-type: none"> <li>■ The air conditioner was just turned on.</li> </ul>	<ul style="list-style-type: none"> <li>• After the air conditioner is turned on, you need to give the air conditioner some time to cool the room.</li> </ul>
	<ul style="list-style-type: none"> <li>■ Cold air is escaping.</li> </ul>	<ul style="list-style-type: none"> <li>• Check for open furnace floor registers and cold air returns.</li> <li>• CLOSE the air conditioner vent.</li> </ul>
	<ul style="list-style-type: none"> <li>■ Cooling coils are iced up.</li> </ul>	<ul style="list-style-type: none"> <li>• See <b>Ice appears on the air conditioner</b> below</li> </ul>
Ice appears on the air conditioner.	<ul style="list-style-type: none"> <li>■ The cooling coils are iced over.</li> </ul>	<ul style="list-style-type: none"> <li>• Ice may block the air flow and obstruct the air conditioner from properly cooling the room. Set the mode control at High Fan or High Cool with the high temperature.</li> </ul>

