



# EGA4 Combustion Analyzer



## INTRODUCTORY NOTE

**NOTE: THIS MANUAL IS VALID FOR INSTRUMENTS WITH SERIAL NUMBER 25865 AND FIRMWARE REV. 2.001 OR HIGHER**

*This manual has all the information you need to install, operate and maintain the flue gas analyzers **EGA4** and its accessories.*

***Eclipse** has used the best care and efforts in preparing this book and believes the information in this publication are accurate. The **Eclipse** products are subjected to continuous improvements, in order to pursue the technological leadership; these improvements could require changes to the information of this book.*

***Eclipse** reserves the right to change such information without notice.*

*The **EGA4** gas analyzers uses sophisticated analogic and digital technologies. Any maintenance operation must be carried out by qualified personnel **ONLY**. **Eclipse** supplies instructions and operative procedures for any operation on the instrument. We recommend to contact our technicians for any support requirements.*

*The instrument is supplied by a Ni-MH rechargeable battery pack or by 100, 115, 230V  $\pm 10\%$  50/60Hz line supply using the special power supply module provided with the instrument.*

***Eclipse** shall not be liable in any event, technical and publishing error or omissions, for any incidental and consequential damages, in connection with, or arising out of the use of this book.*

*The operator must not use this equipment for any other purpose than that stated.*

*This document is the property of **Eclipse** and may not be copied or otherwise reproduced, communicated in anyway to third parties, not stored in any Data Processing System without the express written authority of **Eclipse**.*

## TABLE OF CONTENTS

<b>1</b>	<b>GENERAL DESCRIPTION .....</b>	<b>5</b>
1.1	Specifications.....	6
1.2	Accuracies and ranges .....	7
<b>2</b>	<b>GENERAL .....</b>	<b>8</b>
2.1	Keypad & Display.....	8
2.2	Built-in printer.....	8
2.3	Gas sampling probe.....	8
2.4	Measuring cells.....	8
2.5	Temperature probes .....	8
2.6	Pressure sensor.....	8
2.7	Fuel technical data.....	8
2.8	Smoke measurement.....	9
2.9	Remote temperature probe.....	9
2.10	T+RH% probe .....	9
2.11	Ambient CO probe .....	9
2.12	Natural gas probe.....	9
2.13	Leakage checking mode .....	9
2.14	Burner pressure probe .....	9
2.15	Pitot tube.....	9
2.16	Calibration certificate.....	9
<b>3</b>	<b>PHYSICAL DESCRIPTION .....</b>	<b>10</b>
<b>4</b>	<b>PRINCIPLE OF OPERATION .....</b>	<b>11</b>
4.1	Measurement principle.....	11
4.1.1	Gas sampling probe .....	11
4.1.2	Water trap & line filter.....	12
4.1.3	Gas sensors .....	12
4.2	Auxiliary measurements.....	13
4.2.1	Temperature measurements .....	13
4.2.2	Pressure and Draft.....	13
4.2.3	Smoke index measurement .....	13
4.2.3.1	Measuring instruments (option).....	14
4.2.4	Other measurements .....	14
<b>5</b>	<b>RECOMMENDATIONS .....</b>	<b>15</b>
5.1	Power supply .....	15
<b>6</b>	<b>CONNECTIONS .....</b>	<b>16</b>
6.1	Electro-pneumatic connections.....	16
6.2	Gas probe positioning .....	16
<b>7</b>	<b>OPERATIONS .....</b>	<b>18</b>
7.1	Basic operation .....	18
7.1.1	Keyboard.....	18
7.1.2	Display .....	18
7.1.3	Display adjustment.....	19
7.1.4	Numerical input .....	19
7.1.4	Text input .....	20
7.1.5	Select by a list.....	20
7.2	Flue gas analysis .....	21
7.3	Pressure/Draught measurement.....	22
7.3.1	Burner pressure measurement.....	23
7.4	Smoke measurement.....	23
7.4.1	Input of the smoke index .....	24
7.5	Combustion air temperature (option) .....	24
7.6	Flow/Return temperature .....	24
7.7	Gas speed measurement.....	25
7.8	Analysis data print.....	26
7.8.1	Paper and Ribbon change .....	26
7.9	Pressure decay procedure (option).....	27
7.10	Ambient CO probe (option) .....	29

7.10.1	CO probe operations .....	29
7.11	Natural gas leak checker (option).....	30
7.12	Temperature & Humidity probe (option).....	30
<b>8</b>	<b>MEMORY MANAGEMENT .....</b>	<b>32</b>
8.1	Store data analysis .....	32
8.2	Delete memory.....	32
8.3	Recall memory .....	32
8.4	DBGas 2000 .....	33
8.4.1	Plants/Clients menu .....	33
8.4.2	Analysis menu.....	35
8.4.3	Fuels menu .....	36
8.4.4	DBGas 2000 Installation .....	37
8.5	Configuration Software .....	38
8.5.1	How operate using GasConfig .....	38
8.5.2	GasConfig Installation .....	39
<b>9</b>	<b>CONFIGURATION .....</b>	<b>40</b>
9.1	Engineering Units.....	40
9.2	Alarms.....	40
9.3	HELP key.....	41
9.3.1	Header setting.....	41
9.3.2	Sensor Diagnostic.....	41
9.3.3	Service Data.....	42
<b>10</b>	<b>MAINTENANCE .....</b>	<b>43</b>
10.1	Error messages.....	43
10.2	Set-up menu.....	43
10.2.1	Clock.....	44
10.2.2	Serial Port .....	44
10.2.3	Analysis.....	45
10.2.4	Leak test time.....	45
10.3	Firmware Upgrade .....	46
10.4	Smoke pump maintenance .....	46
<b>11</b>	<b>CERTIFICATES.....</b>	<b>47</b>
11.1	Warranty terms.....	47
11.2	Letter of conformity .....	47
<b>APPENDIX .....</b>	<b>48</b>	
A1	Example.....	48

## 1 GENERAL DESCRIPTION

**EGA4** is designed to satisfy the market needs; but they are the result of the advanced research and experience of **Eclipse**. **EGA4** is a multigas compact palm-top multifunction instrument. The micro-processor based instrument includes a flue gas analyzer, an emissions monitor and an ambient parameters indicator. Two internal electrochemical sensors read the Oxygen (O<sub>2</sub>) and carbonic monoxide (CO) gas concentration. The gas temperature and air temperature are used in connection with the gas analysis to calculate the efficiency, excess air, and CO<sub>2</sub> concentration. A 10 gas parameters programmable table is used for calculations approved in accordance with DIN33962.

A third cell (NO or SO<sub>2</sub>) enables the pollution measurement. The NO concentration can be expressed in terms of NO<sub>x</sub> as required by ambient laws.

External sensors are available for ambient parameters measurement: ambient relative humidity and temperature (T+RH%), ambient CO, to check and evaluate gas network leakage and natural gas leakage detector.

**EGA4** can install a forth electrochemical sensor to monitor pollution. In this way you can measure simultaneously and using a single unit, NO/NO<sub>x</sub> and SO<sub>2</sub> gas concentration.

The instruments are completed with a pressure (draught) sensor, an internal printer, an internal memory for storing data and a RS232 serial interface for configuration and data transfer from and to a PC.

- ◆ Draft measurement is possible using the internal pressure sensor and the special gas sample probe.
- ◆ The optional internal printer is impact type and the generated document is very legible and has a long time duration.
- ◆ The internal standard memory may store up to 250 complete gas analysis divided by Tag.
- ◆ The instruments have a standard IR serial interface and an optional RS232 conversion module and a configuration PC software are available to configure the analyzer.



### Features & Benefits

- **New user friendly interface**: very intuitive and in English language to use the instrument without instruction manual.
- **Large dimensions and lighting LCD display**: very legible using the "Zoom" function and the automatic back-light device.
- **Easy and quick upgrading** hardware and software are made using modular design to upgrade the system yourself.
- **Differential pressure measurement**: gas velocity, pressure, draft,  $\Delta P$ , etc.
- **Averaging** between three gas analysis.
- **Internal impact type printer**: more legible and long time duration for you documents.
- **Single battery pack**: rechargeable to power both the instrument and the printer.
- **Internal memory**: up to 250 complete data analysis.

## 1.1 Specifications

- **Type:** 2, 3 or 4 cells palm-top flue gas analyzer.
- **Calibration:** automatic calibration procedure at instrument switching-on.
- **Self-diagnosis:** Sensors efficiency test with anomalous status announcement.
- **Fuel types:** Up to 10 totally programmable.
- **Pump:** rate of flow 0.8 lit / head –230mbar  
*All data measured using 3 meters long probe and line filter connected. Load loss = 10 mbar using a 3 meters probe extension*
- **Power supply:** High capacity Ni-MH rechargeable battery pack / external battery charger.
- **Charging time :** 8h at 90% with instrument off.
- **Battery life:** 5h continuous operation (without printer and back-light).
- **Printer:** Impact type 24 columns with 58 mm large and 18 meters long paper roll
- **Printer power supply:** using the analyzer battery pack.
- **Print autonomy:** up to 30 reports with battery full
- **Automatic CO(ppm) and CO(%) selector:** if the sensors are installed.
- **Internal data memory:** up to 250 complete analysis data structured by Tags.
- **Service and user data:** 3 programmable lines for each programmed customer using a PC and DBGas Software.
- **Report Herder:** 4 rows x 16 characters programmable from keyboard
- **Display:** Large (40x56 mm) graphic LCD display with automatic back-light device. Bargraph and trend capability as option.
- **Serial interface:** Bi-directional infrared interface. External IR/RS232 converter available for PC communication.
- **Synchronous serial port:** for external keyboard and optical bar pen reader.
- **Smoke measurement:** Using the optional external manual pump. Bacharach index memory store and printout capability as standard.
- **Optional probes:** ambient CO, Bar pen, explosive gas leakage sniffer, T+RH% probe.
- **Working temperature:** from –5°C to +45 °C (up to 50°C for short time)
- **Storage temperature:** from –20 to +60°C (3 months maximum at temperatures exceeding the operational limits).
- **Dimensions:** 115x90x330 mm
- **Weight:** 1.1 kg battery and printer included

### External optional ambient CO probe

- **Range:** from 0 to 500ppm
- **Accuracy:** ±5ppm up to 100ppm; ±5% up to 500ppm
- **Resolution:** 1ppm
- **Response time:** 30s (t90)
- **Waiting starting time:** 30s
- **Working temperature:** from –5°C to +45 °C

### External optional ambient T+RH probe

- **Temperature Range:** from 0°C to 85°C
- **Temperature Accuracy:** ±1°C
- **Temperature Resolution:** 0.1°C
- **Relative Humidity Range:** from 0 to 99%RH
- **Relative Humidity Accuracy:** ±5%RH
- **Relative Humidity Resolution:** 0.1%RH
- **Response time:** 50s (t63)
- **Waiting starting time:** 30s
- **Working temperature:** from –0°C to +50 °C (up to 85°C tip only)

### External optional natural gas leak detection probe

- **Pre-heating time:** 30s minimum
- **Alarms indication:** visual with 5 steps
- **5 alarms levels:** 100, 200, 300, 400, 500 ppm
- **Acoustic Alarm indication:** respectively 1, 2, 3, 5 beep/s, continuous
- **Response time:** 5s (t90)
- **Alarm levels Accuracy:** ±10% at 90 days

## 1.2 Accuracies and ranges

Parameter	Sensor type	Range	Resol.	Max response	Accuracy
O <sub>2</sub>	Electrochemical	from 0 to 25.0%	0.1%	20 sec.	±0.1% vol.
CO <i>H<sub>2</sub> compensated up to 1000ppm</i>	Electrochemical	from 0 to 8000 ppm	1 ppm	50 sec.	±10 ppm <300 ppm ±4% rdg up to 2000 ppm ±10% rdg >2000 ppm
CO	Electrochemical	from 0 to 20000 ppm	1 ppm	40 sec.	±10 ppm <300 ppm ±4% rdg up to 2000 ppm ±10% rdg >2000 ppm
NO	Electrochemical	from 0 to 4000 ppm	1 ppm	40 sec.	±5 ppm <125 ppm ±4% rdg >125 ppm
NO <sub>2</sub>	Electrochemical	from 0 to 1000 ppm	1 ppm	50 sec.	±5 ppm <125 ppm ±4% rdg >125 ppm
NO <sub>x</sub>	Calculated	from 0 to 5000 ppm	1 ppm		
SO <sub>2</sub>	Electrochemical	from 0 to 4000 ppm	1 ppm	40 sec.	±5 ppm <125 ppm ±4% rdg >125 ppm
CO <sub>2</sub>	Calculated	from 0 to 100%	0.1 %		
Tair	Pt100	from -10 to 100 °C	0.1 °C		±(0.2% rdg+0.15°C)
Tgas	Tc K	from -10 to 1000 °C	0.1 °C		±(0.3% rdg+0.3°C)
ΔT	Calculated	from 0 to 1000 °C	0.1 °C		
Tflow	Tc K	from -10 to 100 °C	0.1 °C		±(0.3%rdg+0.3°C)
Treturn	Tc K	from -10 to 100 °C	0.1 °C		±(0.3% rdg+0.3°C)
Pressure/Draft & ΔP	Piezo	-10hPa to +100 hPa	0.01 hPa		±1% rdg
Excess air	Calculated	from 1.00 to infinite	0.01		
Efficiency	Calculated	from 0 to 100%	0.1 %		
Gas speed	Pitot tube	From 0 to 100.0 m/s	0.1 m/s		
Smoke index	External pump	from 0 to 9			

- *Technical units and ranges can be converted directly from ppm to mg/Nm<sup>3</sup>, mg/kwh and from hPa to mmH<sub>2</sub>O, mbar or inH<sub>2</sub>O.*
- *The relative accuracy shown are expressed as absolute or % of rdg errors at -5°C to +40°C ambient temperature.*
- *The maximum response time shown is referred to 90% signal changes.*
- *The pressure relative accuracy shown is valid only after the auto-zero procedure.*

Specifications may change without notice.

## **2 GENERAL**

### **2.1 Keypad & Display**

The tactile keyboard allows the operator to enter the main operative mode and all other complementary or auxiliary modes following the menu driven instructions.

The high contrast graphic LCD (40x56 mm), equipped with an automatic back-light device, displays the measured and/or calculated parameters in the preferred format (Zoom function). The above parameters can be also displayed in a graphic mode.

### **2.2 Built-in printer**

**EGA4** can be equipped with a built-in, rugged, impact type printer. It uses a low cost common roll of paper (58 mm large, 18 meters long), more readable, long time and heat resistant better than the thermal printout on chemical paper. One key instruction is enough to obtain one, two or more copies of the analysis report with header and company reference data.

### **2.3 Gas sampling probe**

Flue gas sampling probes with different length, shape and max. operating are available to match the requirement of different applications. The sampling probe is connected to the instrument with a rubber hose through a combined module of water trap and suspended particle filter.

### **2.4 Measuring cells**

**EGA4** uses long life sensors for O<sub>2</sub>, CO (H<sub>2</sub> compensated), NO, NO<sub>2</sub> and SO<sub>2</sub>. An automatic device exclude automatically the CO sensor when CO high concentration level is identified.

Four acoustic and visual alarms can be set on four programmable parameters.

### **2.5 Temperature probes**

A thermocouple type K is incorporated on the tip of the gas sampling probe to measure the flue gas temperature. This thermocouple is suitable for measurements up to 800°C (max 1000°C for few seconds). Temperature measurement and gas sampling from the flue gas pipe are thus always performed in the same site.

The probe is connected to the instrument with the appropriate compensated cable and connector. A Pt100 resistance thermometer (local jig or remote sensor) is used for the air temperature measurement and best efficiency calculation.

### **2.6 Pressure sensor**

The instrument is equipped with an internal sensor for pressure and stack draught. One key instruction move the operative mode to and from this function to gas analysis and viceversa. The instrument has, as standard feature, a differential pressure sensor.

### **2.7 Fuel technical data**

The instrument includes as standard the technical data for 4 of the most common fuels.

Using the optional GasConfig software, it is possible to modify or add data of up to 10 different fuels.



## **2.8 Smoke measurement**

Smoke index measurement is done by using a hand pump (supplied as an accessory), the results can be memory stored and printed in the report.

## **2.9 Remote temperature probe**

A remote Pt100 probe is available for combustion air temperature measurement from  $-10^{\circ}\text{C}$  to  $100^{\circ}\text{C}$ . This probe is strongly recommended mainly in forced air boiler to obtain an accurate calculation of the efficiency.

## **2.10 T+RH% probe**

Optional probe for simultaneous measurement of ambient temperature and relative humidity (%RH) for comfort index computation.

## **2.11 Ambient CO probe**

Optional probe to monitor CO concentration and therefore safety condition in the boiler room. The instrument gives acoustic and visual alarm if the set limit (according to the OSHA recommendation) are exceeded.

## **2.12 Natural gas probe**

Optional probe to monitor  $\text{CH}_4$  and natural gas concentration and detect and locate the position of a gas leak into the domestic pipe network.

## **2.13 Leakage checking mode**

To check gas network tightness using a pressure decay method at programmable interval time. It uses the internal pressure sensor and a Eclipse leakage procedure.

## **2.14 Burner pressure probe**

A 1 meter 8x4mm silicon hose is used to check the pressure inside the burner when you are installing the heating system.

## **2.15 Pitot tube**

The **EGA4** analyzer can be connected to a Pitot tube for gas speed measurements.

## **2.16 Calibration certificate**

Each **EGA4** portable gas analyzer, is factory calibrated and certified against **Eclipse** Standards, that are periodically certified by an International recognized Laboratory, and shipped with a Report of Calibration stating the nominal and actual values and the deviation errors.

## 3 PHYSICAL DESCRIPTION

The **EGA4** portable analyzer consists of a rugged and compact case, a mother board with all base function circuits, 2, 3 or 4 electrochemical cells, a gas pump, a keyboard, an LCD backlighted display, a Ni-MH rechargeable battery pack and, optionally an impact printer.

The 2 pieces of the case are joined by 8 screws. The batteries, the pneumatic circuit and the cells are positioned in the rear of the analyzer and 2 screws locked the lid.

A pressure lid allows to remove the paper roll.

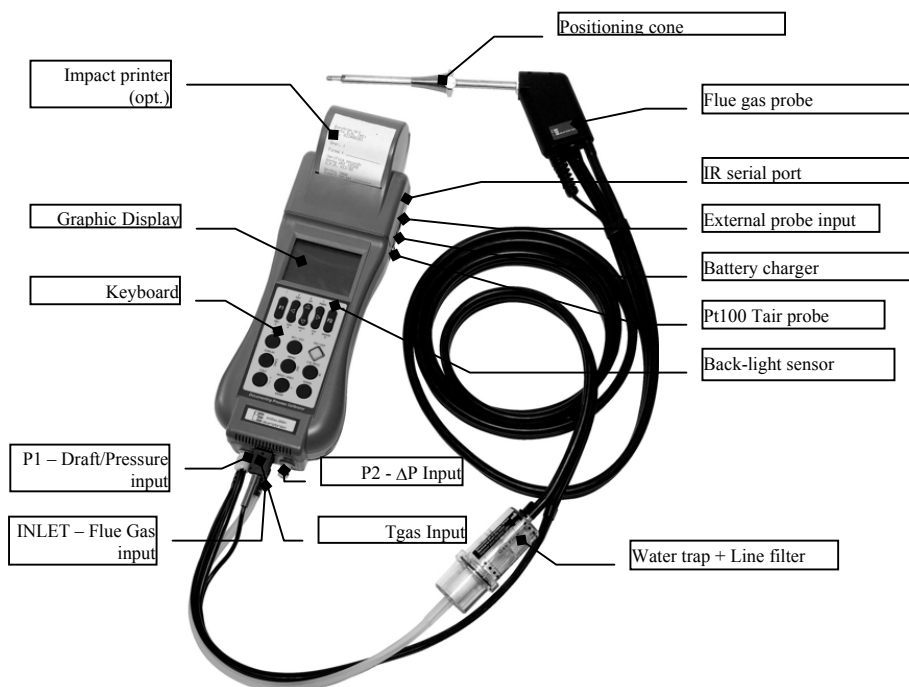

At the bottom of **EGA4** you can see all sampling probe connectors: gas inlet, pressure and draught input, thermocouple input for gas measurement and the 2<sup>nd</sup> pressure inlet connector.

On the left side are the connectors for: line power charger, synchronous serial input connector for bar pen and keyboard, the input for the auxiliary probes (T+RH%, leak checker, etc.) and the infrared LED for PC serial communication (an optional IR/RS232 and software should be used to configuring and transfer the analysis data).

The operator interface is on the front of the instrument and it consists of: a high contrast LCD display and a 14 button keypad. An automatic back-light device and a "zoom" function, make easier the data reading on the display. The most used operation (analysis, draught, printing and smoke index) can be accessed by operator pressing a single key.

## 4 PRINCIPLE OF OPERATION

The **EGA4** analyzer is based on the following functional blocks:

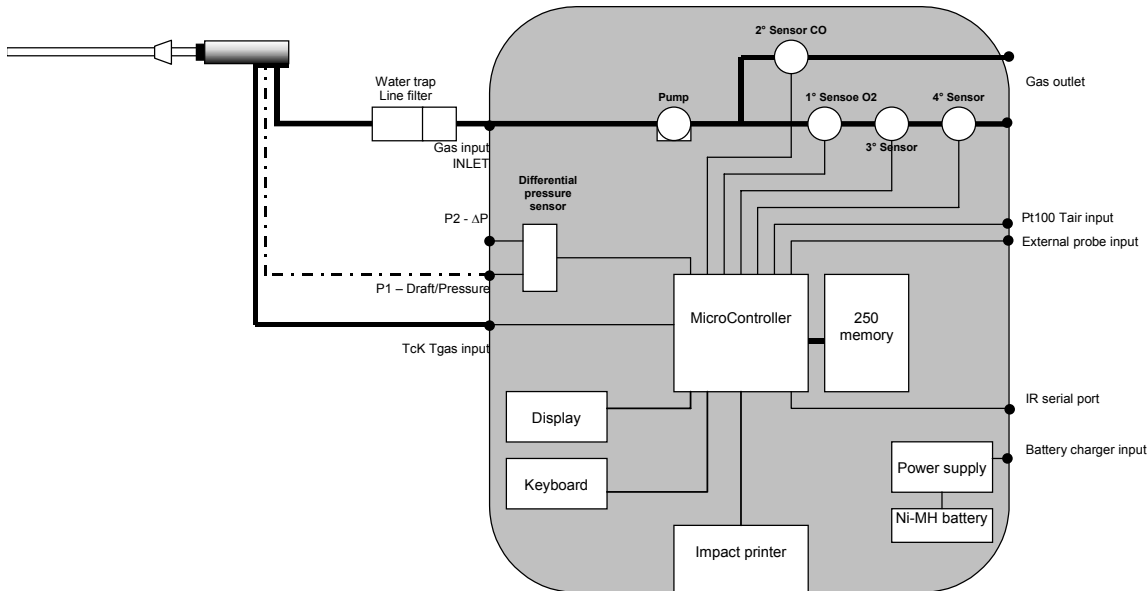

### 4.1 Measurement principle

The gas is sampled and aspirated through the probe with a primary pump powered at constant voltage.

To position the sampling probe in the exhaust gas pathway a hole of 11mm, up to 16mm, should be drilled and the retaining cone of the sampling probe firmly screwed in it.

The retaining screw in the cone enables the probe to be easily moved to locate the core flow, normally correspondent to the center of the section of the smoke tube. The flue gas and exhaust gas pathway, should be checked for gas-tightness before carrying out a measurement and, if necessary, non gas-tight points should be sealed.

The O<sub>2</sub> sensor is essentially an electrochemical cell, with two electrodes and electrolyte solution. The behavior is similar to a normal battery and therefore the sensitivity decreases with time. The expected life does not relate to the operative time and is lost after approximately 24 months.

The toxic gas measurements (CO, SO<sub>2</sub>, NO and NO<sub>2</sub>) use electrochemical cells, with an expected operative life of 3 years.

The electrochemical cell grants accurate results for time intervals of approximately 60 minutes. The zero drift is automatically corrected by the instrument every time the instrument is switched-on, using fresh ambient air as reference. This operation should be made with the sampling probe not inserted in the chimney or with the sampling probe pneumatic connector disconnected from the analyzer gas inlet.

When a long time analysis has to be made, a new autozero procedure should be performed.

The pressure/draught sensor is based on the principle of the extension metric measuring bridge. When the instrument is switched-on, a zero calibration of the draught/pressure circuit is also executed. Leave open the "ΔP" connector during this phase.

Measured and calculated parameters are indicated on a LCD alphanumeric display (40x56 mm), equipped with a automatic back light device for easy readings, also in poor light conditions.

#### 4.1.1 Gas sampling probe

The sampling probe consists of a steel tube and a handle of thermoinsulating material. A positioning cone allows to place the probe in holes with a diameter from 11 to 16 mm.

The gas temperature is acquired using a thermocouple type K with the junction placed on the top of the tip.

## 4.1.2 Water trap & line filter

The gas flows through an external combined water trap and line filter to avoid the presence of condensation and suspended solid particles in the analysis section of the instrument. A cylinder is positioned at 15 cm from the instrument gas inlet it is divided into two parts: the water trap and the line filter.

The **water trap** works using the expansion principle: the gas flow decreases its speed inside the cylinder and it will cool; the humidity will condense and the solid particles fall down. The section of the water trap must be periodically drained off to avoid water from entering the analysis section. Pull the rubber plug and shake slowly the trap to drain the water. Push the rubber plug to close the trap hole.

The **line filter** is positioned after the water trap and before the electrochemical cell. Its function is to stop the smallest solid particles before the analysis. Remember to change the filter every time it is dirty.

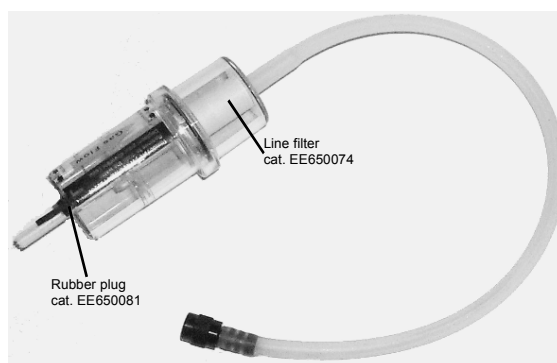

### WARNING

**THE WATER TRAP MUST BE KEPT IN VERTICAL POSITION DURING GAS SAMPLING. AN INCORRECT POSITIONING OF THE TRAP CAN ALLOW THE WATER TO ENTER INSIDE THE ANALYZER AND DAMAGE THE ELECTROCHEMICAL SENSORS.**

**NEVER MAKE ANY ANALYSIS WITHOUT THE DRAINING RUBBER PLUG. THE MEASUREMENTS WILL BE INCORRECT.**

**WHEN YOU FINISH THE ANALYSIS, REMEMBER TO DRAIN THE WATER TRAP. BEFORE PUTTING THE GAS PROBE IN THE CARRYING CASE, REMOVE THE CONDENSATE WATER FROM THE PROBE HOSE.**

**THE LINE FILTER SHOULD BE REPLACED WHEN DIRTY. NEVER MAKE ANY ANALYSIS WITHOUT LINE FILTER AND/OR WATER TRAP, AS IT CAUSES AN IRREVERSIBLE DAMAGE TO THE ELECTROCHEMICAL SENSOR.**

## 4.1.3 Gas sensors

The analyzer uses long life sensors for O<sub>2</sub>, CO (H<sub>2</sub> compensated), NO, NO<sub>2</sub> and SO<sub>2</sub>. The sensor do not need special maintenance but must be replaced after the expected lifetime.

**However a full maintenance and certification of the instrument is recommended at one year interval.**

The gas sensors are electrochemical cells composed by two electrodes (anode and cathode) and an electrolyte solution. The sampled gas goes trough a selective diffusion membrane.

The oxidation process produces an output electrical signal proportional to the gas concentration. The signal is evaluated by the electronics, converted to digital, processed by the microprocessor, displayed and printed with a 0.1% volume resolution.

The flue gas must not be at a pressure that could damage or destroy the sensor. Measurements are always carried out under "pressureless" conditions. The maximum permissible excess/reduced pressure is  $\pm 100$  mbar.

Each sensor has a different response time:

O <sub>2</sub>	= 20s to 90% of reading
CO (H <sub>2</sub> comp.)	= 50s to 90% of reading
CO	= 50s to 90% of reading
NO	= 40s to 90% of reading
NO <sub>2</sub>	= 50s to 90% of reading
SO <sub>2</sub>	= 40s to 90% of reading

**NOTE: TO OBTAIN AN ACCURATE MEASURE IT IS RECOMMENDED TO WAIT 3/5 MINUTES.**

Toxic gas sensor can be present a  $\pm 2\%$  drift and a long resuming time if an excessive ( $>150\%$  of F.S.) gas concentration is applied. In that case it is recommended to wait for a measured value lower than 20ppm, by sucking fresh air before switch the analyzer off.

An optional Electro-valve can be installed inside the instrument to exclude/include manually or automatically the CO cell when the CO concentration is too high (e.g. when the burner is starting)

Four acoustic and visual alarm levels can be set on four programmable parameters.

## 4.2 Auxiliary measurements

### 4.2.1 Temperature measurements

The instrument is equipped with two temperature inputs to measure exhaust gas and the burner air input temperatures (combustion gas).

- ◆ A thermocouple type K (nickel-nickel chromium) is included in the tip of the gas sampling probe to measure the flue gas/exhaust gas temperature. This thermocouple is suitable for permanent measurements at temperatures up to  $800^{\circ}\text{C}$  and for short-term measurements up to  $1000^{\circ}\text{C}$ . Temperature measurement and gas sampling from the flue gas pathway are thus always performed at the same site. The probe is connected to the apparatus with compensated cable and connector. An internal Pt100 resistance thermometer is used for cold junction compensation.
- ◆ The same Tc K input can be used to measure the flow and return temperature in water circuit. If you have to measure the water temperature measuring the pipe temperature, use an arch-model thermocouple with an appropriate diameter.
- ◆ A remote Pt100 sensor, can be supplied on request with a 2 or 5 meter cable to measure the air inlet temperature in forced air boiler. This option is very important for an accurate efficiency calculation.

### 4.2.2 Pressure and Draft

The analyzer can be equipped with a temperature compensated pressure sensor to measure the chimney draft or pressure. The pressure range is from  $-1500.0$  to  $+1500.0$  mmwc ( $\pm 150.00$  hPa)

The sensor is factory calibrated and does not require manual adjustment.

The zero drift, caused by ambient air temperature variation, is automatically cancelled at each instrument start-up. In addition, for more accurate readings the operator can reset, using the pertinent key, the zero if required. The instrument sensor is differential type and, if connected to a Pitot tube, it can be used to measure gas speed.

**NOTE: WE SUGGEST TO EXECUTE THE AUTOZERO PROCEDURE FOR MORE ACCURACY BEFORE PERFORM THE MEASUREMENT.**

#### CAUTION

IF A SINGLE TUBE GAS SAMPLING PROBE IS USED FOR PRESSURE/DRAFT MEASUREMENTS, BE SURE THAT IT IS CLEAN AND DRY BEFORE CONNECTION TO THE PRESSURE INPUT.

#### CAUTION

A  $+300\text{hPa}$  (OR  $-300\text{hPa}$ ) OVER-PRESSURE CAN PERMANENTLY DAMAGE THE PRESSURE SENSOR.

### 4.2.3 Smoke index measurement

This method consists of taking a gas sample from the center of the gas pipe behind the heat exchanger and crossing it through a special filter paper.

The color of the spot on the filter is compared with a graduated (from 0 to 9) reference scale and it is called "smoke index".

You can type in the instrument up to 3 smoke index values; the analyzer calculate the average value and can print these values on the report.

Normative and laws about the air pollution, describe the procedure: DIN51402, 2116, 2117 and 2297 VDI directives, ASTM D 2156-63 T, etc.

### 4.2.3.1 Measuring instruments (option)

1. **Smoke pump:** it should suck 5.75 litres  $\pm 0.25$  l (normalized to 0°C, 760mmHg) through a 1 cm<sup>2</sup> filter.
2. **Smoke index reference table:** it is a grey scale sheet with 10 different areas numbered from 0 to 9. The number 0 corresponds to a 85%  $\pm 2.5\%$  reflection. Every area reflects 10% less than the previous one. The scale is used to compare the scale with the paper filter and to calculate the smoke index.
3. **Paper filter:** When it is clean it has a reflection corresponding to the 0 scale index. It also has 3 litres per cm<sup>2</sup> a minute (normalized to 0°C, 760mmHg) with a 200/800 mmwc resistance to the air flux.

### 4.2.4 Other measurements

The analyzer has an auxiliary input for special probes connections. Available probes are: ambient CO monitoring, temperature & humidity (T+RH%) measurement and natural gas monitoring probes.

An optional operative mode is the leakage pipe test to check gas network tightness using pressure decay method at programmable interval time.

## 5 RECOMMENDATIONS

- The analyzer should be used in environments where the temperature is between -5°C and +45°C.
- When the analysis are completed, before switch the instrument off, remove the probe from the gas pathway and wait about 30 seconds cleaning the pneumatic circuit from gas.
- Do not use the analyzer with clogged filters or filled with humidity.
- Before placing the probe in the case, be sure that the probe, the water trap and the hose are clean and cold.
- If you have ordered a double hose sampling probe, insert both connectors to the instrument during the gas analysis (pay attention to color correspondence).
- To empty the water trap from the condensate water, remove the draining plug. DO NOT OPEN the water trap. DO NOT leave the water trap without the draining rubber plug.
- **For the best efficiency and accuracy, we suggest to calibrate the instrument every year.**

### WARNING

**IF THE EGA4 IS STORED AT TEMPERATURE EXCEEDING THE OPERATIVE LIMITS, THE ANALYZER NEEDS SOME MINUTES TO WARM-UP TO THE ACTUAL AMBIENT TEMPERATURE, BEFORE STARTING THE OPERATION.**



### 5.1 Power supply

The instrument can be powered from:

- internal rechargeable Ni-MH battery.
- External battery charger, supplied as a standard accessory (the batteries must be installed).
- Optional external DC auto battery charger (the batteries must be installed).

The Ni-MH rechargeable batteries allows a long time operation and do not need maintenance. The same batteries power both the instrument and the internal printer. The internal battery will grant 5 hours continuous operation (without printing and display back light off).

**NOTE: 90% BATTERY CHARGING CAN BE OBTAINED IN 8 HOURS WITH THE INSTRUMENT SWITCHED OFF.**

During operation a fully battery symbol “” will be displayed on the display. This symbol means that the batteries are completely full. When the batteries will be discharged the symbol “” will appear and the instrument still has about 20 minutes operation capability to end the running analysis.

The battery symbol indicates that a full charge is required. Use only the dedicated battery charger supplied by Eclipse together the instrument.

**CAUTION: OLD BATTERIES CAN LEAK AND CAUSE CORROSION. NEVER LEAVE RUN DOWN BATTERIES IN THE INSTRUMENT**

### WARNING

**THE INSTRUMENT IS SHIPPED WITH AN AVERAGE LEVEL OF BATTERY CHARGE. AFTER UNPACKING, A FULL CHARGE OF THE BATTERY IS RECOMMENDED, BY CONNECTING THE INSTRUMENT TO THE MAIN LINE THROUGH THE BATTERY CHARGER (OFF CONDITION) FOR 8/10 HOURS.**

## 6 CONNECTIONS

### 6.1 Electro-pneumatic connections

To prepare the instrument for operation connect the sampling probe to the instrument:

- Plug the pneumatic connector of the probe to the GAS INLET connector. If you are using the gas sampling probe with Draft option, connect also its connector to the instrument Pressure/Draft inlet.
- Plug the probe temperature sensor plug to the pertinent connector.
- For more accurate readings and efficiency calculations, plug the remote air temperature Pt100 sensor to the 3 pin connector on the left side of the instrument.

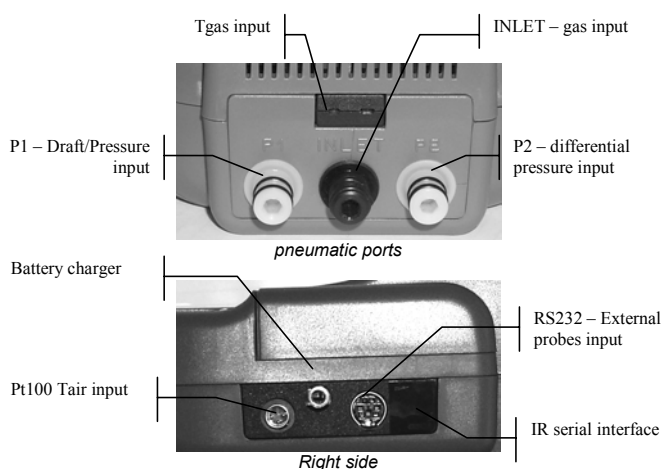

### 6.2 Gas probe positioning

The measurement site should be arranged at a distance of  $2xD$  behind the exhaust gas connection pipe, where  $D$  = diameter of the exhaust gas connection pipe.

To position the sampling probe in the exhaust gas pathway a hole of 11/16mm should be drilled and the retaining cone of the sampling probe firmly screwed in it.

The retaining screw in the cone enables the probe to be easily moved in order to locate the core flow, normally correspondent to the center of the section of the stack.

The flue gas and exhaust gas pathways, must be checked for gas-tightness before carrying out a measurement and, if necessary, non gas-tight points should be sealed.

To locate the gas core flow, insert progressively the sampling probe and read the maximum value of temperature.



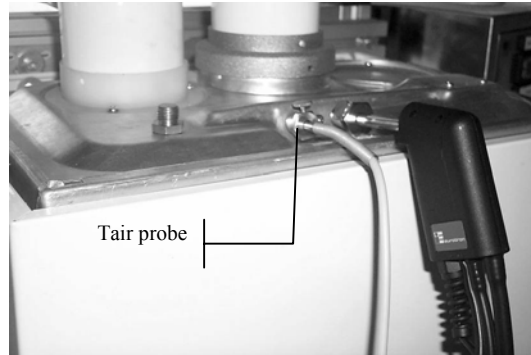

## CAUTION

**FOR A CORRECT GAS ANALYSIS, NO AIR MUST REACH THE FLUE GAS AS A RESULT OF NON-GAS-TIGHT CONNECTION POINTS BETWEEN THE HEAT PRODUCER AND THE MEASUREMENT SITE (PROBE).**

**THE FLUE GAS AND EXHAUST GAS PATHWAYS MUST BE CHECKED FOR GAS-TIGHTNESS BEFORE CARRYING OUT A MEASUREMENT, AND IF NECESSARY NON-GAS-TIGHT POINTS SHOULD BE SEALED.**

## 7 OPERATIONS

### 7.1 Basic operation

All the procedures and programming operations on the **EGA4**, can be made using the keyboard and the display.

**NOTE: ALL NUMERIC VALUES SHOWN IN THE FIGURES OF THIS MANUAL ARE INDICATIVE AND LISTED AS AN EXAMPLE.**

The analyzer should be used in environments where the temperature does not exceed the specified limits (from -5°C to +45°C) and where the relative humidity is lower than 95% non-condensing.

#### 7.1.1 Keyboard

The front panel keys functions are the following:

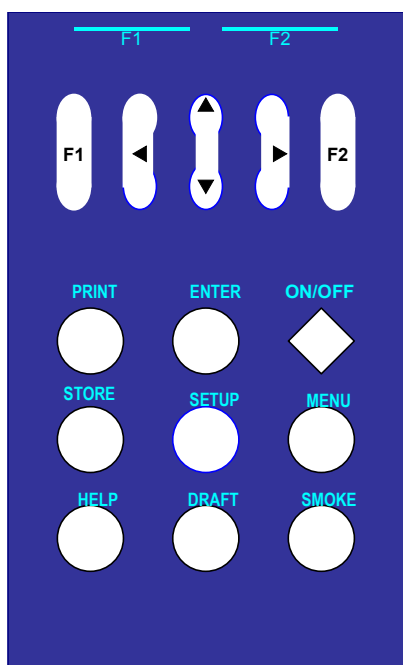

[F1] and [F2]

This keys are multifunction. The instrument change the assigned function during the operations. All displayed pages have, in the bottom, 2 boxes each containing the assigned function (e.g. ANALYSIS). If no word is displayed inside the box, no function is assigned to that function key.

[▲], [▼], [◀] and [▶]

They move the cursor symbol or to increase or decrease numerical values.

[ENTER]

Accept and memory store the modified parameter or variable.

[PRINT]

Print the report of the analysis.

[ON/OFF]

Switch the analyzer on or off.

[STORE]

Read or store the analysis data from or in the memory.

[SETUP]

Go to the configuring page of the instrument.

[MENU]

Go to the auxiliary function (Ambient measurements, Flow and return Temperature, etc.) menu.

[DRAUGHT]

Go to the Pressure/ Draught measurement.

[SMOKE]

Allows the data input for smoke index measurements. You need an external pump for the gas sampling.

[HELP]

Display the most important information for the service: the battery charging level, the status of the gas sensors, the free memory, etc.

#### 7.1.2 Display

The **EGA4** is designed with a large (40x56 mm) graphical display using an automatic back light system for the best reading in poor light conditions also. The instrument is able to visualize simultaneously on the display 3, 6 or 12 parameters.

Three different area can be identified on the display: Menu and Measure area, Status bar and Function boxes.

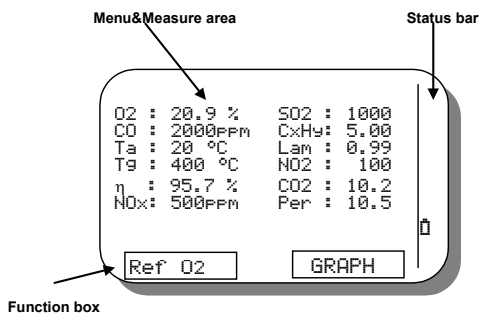

The Menu and Measure area displays the analysis data, the menu and all messages for the operator. The measured and calculated parameters are displayed in different pages of 6 parameters each.

Using the [▲] and [▼] keys you can change page, changing the displayed parameters.

Pressing the [◀] and [▶] keys it is possible to increase or decrease the number of the displayed parameters (ZOOM function).

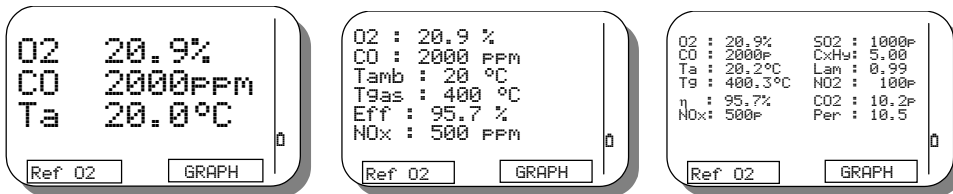

Two boxes are positioned on the bottom of the display. They contains the name of the function assigned to the [F1] and [F2] function keys.

The status bar uses graphical symbols to describe the actual operation mode of the instrument.

🔋 / 🔌	Battery status: 🔋=charged, 🔌=discharged
Max/Min/ Med/Mem	The Max, Med, Min, Actual values are displayed in memory recalling mode.
O2	The displayed measure are referred to oxygen
📄	Memory Card (PCMCIA) inserted.
🔌	Line operations

## 7.1.3 Display adjustment

In autozero procedure, you can press the [◀] and [▶] keys to adjust the LCD contrast.

When the instrument is in measuring mode you should press the [HELP] key and press the [◀] and [▶] keys to adjust the LCD contrast.

## 7.1.4 Numerical input

If you have to set a numerical parameter (e.g. O<sub>2</sub> reference, etc.) use the following procedure:

Select the parameter to be changed (e.g. O<sub>2</sub> reference) with the [▲] and [▼] key from the configuring menu.

Press [ENTER] to enter in modify page as follows:

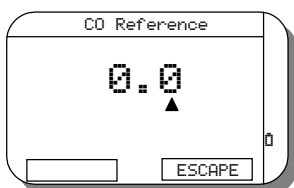

The “▲” symbol below the first digit is the cursor.

You can move the cursor between the digit using the [◀] and [▶] keys.

You can change the selected digit using [▲] and [▼]. If “9” or “0” values are exceeded, the left digit is increased or decrease.

Press [ENTER] to memory store the value and return to the previous page.

Press [ESCAPE] (F1) to return to the previous page without save the changes.

## 7.1.4 Text input

If you have to set a text parameter (e.g. customer name, etc.) use the following procedure:

Select the parameter to be changed (e.g. customer name) with the [▲] and [▼] key from the configuring menu.

Press [ENTER] to enter in modify page as follows:

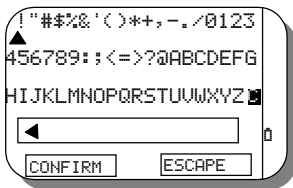

A “▲” symbol below the “ ” (blank) character in figure, represent the cursor. It is used to identify the selected character; you can move it using the [◀], [▶], [▲] and [▼] keys. The box below the characters table shows the currently inserted text. The symbol “◀” is the end of line symbol.

Press [CONFIRM] to write in the line box the selected char. The reversed char “◀”, when selected, delete the last inserted char.

Press [ENTER] to memory store the text and return to the previous page.

Press [ESCAPE] to return to the previous page without save the changes.

## 7.1.5 Select by a list

If you have to set a text parameter (e.g. Tag name, fuel type, etc.) use the following procedure:

Select the parameter to be changed (e.g. fuel type) with the [▲] and [▼] key from the configuring menu.

Press [ENTER] to enter in modify page as follows:

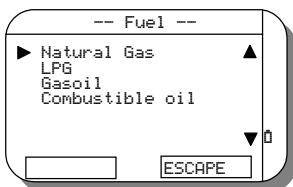

The “▶” symbol on the left is the cursor.

You can move the cursor between the digit using the [▲] and [▼] keys.

Press [ENTER] to memory store the selection and return to the previous page.

Press [ESCAPE] (F1) to return to the previous page without save the changes.

## 7.2 Flue gas analysis

- Connect the gas probe to the analyzer as shown in chapter 7. **DO NOT INSERT THE PROBE IN THE CHIMNEY.**
- Switch the analyzer on pressing the [ON] key. The display will show the following page:

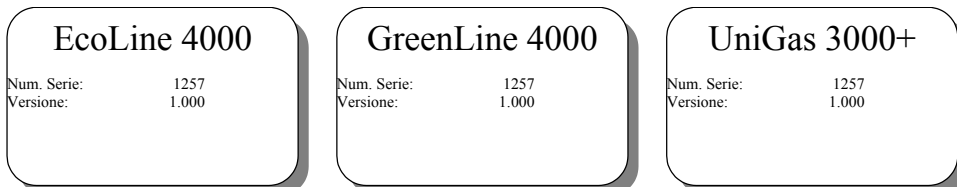

This page changes automatically after some seconds or if you press a key as follows:

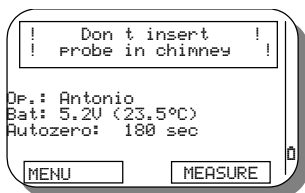

This page displays the following information: operator name, battery charge level, instrument internal temperature and the seconds to end the autozero procedure.

**NOTE: THE ANALYZER MUST DRAW CLEAN AIR FROM THE AMBIENT DURING THE AUTOZERO PROCEDURE. OTHERWISE THE MEASUREMENTS CANNOT BE ACCURATE.**

It is possible to enter in "MENU" page (pressing [F1]) or in "MEASURE" page (pressing [F2]). See the appropriate paragraphs for operations.

When autozero procedure finished, an intermittent sound advise the operator. Press the [ENTER] key to mute the unit. The following page will be displayed:

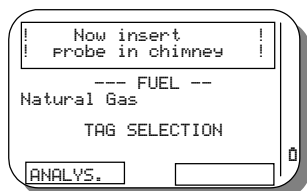

This page allows the operator to change the fuel used and to select the Tag between the available.

- Fuel selection.** Move the cursor symbol "►" on the desired row using the [▲] and [▼] keys. Press [ENTER] to change the value. See instruction on paragraph 8.1.6.
- Tag selection.** Move the cursor symbol "►" on the desired row using the [▲] and [▼] keys. Press [ENTER] to change the value. A new page will be shown. The Tag name, the description and the progressive number will be displayed. See instruction on paragraph 8.1.6. When in measuring mode, you can select another Tag pressing the [MEMORY] key.

- Insert the probe in chimney. Stop it using the retaining cone and adjust the immersion depth for a gas sampling in the middle of the exhaust gas connection pipe.
- Press the [ANALYSIS] (F1) key to begin the measurements. The following page will be shown:

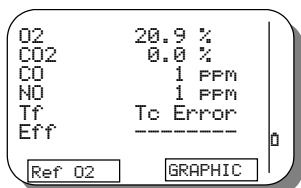

Pressing the [◀] and [▶] keys, it is possible to zoom-in and zoom-out increasing or decreasing the number of displayed parameters.

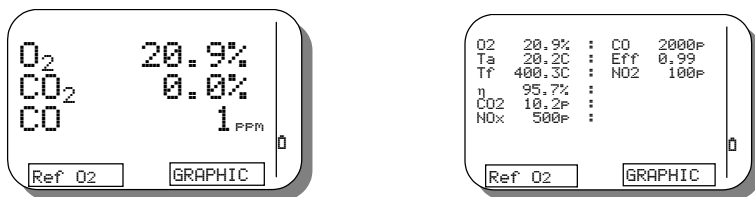

Pressing the [▲] and [▼] you can change page for others parameters.

Pressing the [REF. O<sub>2</sub>] key the measured parameters will be referred to the programmed oxygen value. When selected this mode, the symbol "O<sub>2</sub>" will be displayed on the status bar.

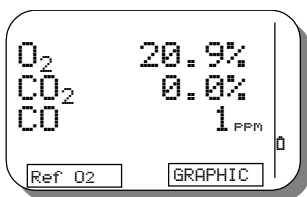

If the graphical option (Table E=4 on ordering code) is installed, the instrument can display the measured values as bar-graph. Press the [GRAPHIC] (F2) key to change mode.

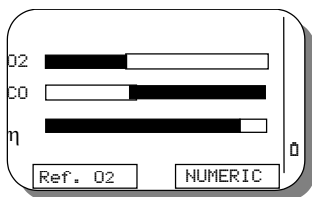

Using GasConfig Software, you can program the graph page: Assign up to 6 different parameter, range and increment direction. See chapter 9 for software instructions.

Press the [NUMERIC] (F2) key to return to the normal display mode.

## 7.3 Pressure/Draught measurement

If the internal pressure sensor is installed (Table E=2 on ordering code), you can execute the pressure/draft measurements using or the standard probe or the special probe.

### Standard probe (TG models):

The standard probe has a single gas collector for gas sampling. Usually you have the hose terminal connected to the instrument gas inlet; when you have to do the draft measurements you have to move the connector to pressure inlet (P IN) connector.

## CAUTION

**IF A SINGLE TUBE GAS SAMPLING PROBE (TG MODEL) IS USED FOR PRESSURE/DRAFT MEASUREMENTS, BE SURE THAT PROBE AND HOSE ARE CLEAN AND DRY BEFORE CONNECTION TO THE PRESSURE INPUT.**

### Special draft probe (TGD models):

This special probe model has a double gas collector: one for the flue gas analysis and one for the draft measurement. When you connect the probe to the analyzer you have to insert both gas inlet and pressure inlet connectors. Connect the hose with line filter to gas inlet connector.

- The pressure measurement requires the instrument in normal operating conditions indicating one of the measured or calculated parameters. Press **[DRAUGHT]** on the keyboard. **DO NOT INSERT THE PROBE IN THE CHIMNEY.** The internal pump will stop and the following page will be shown:

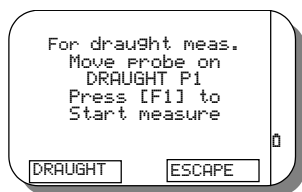

- Press **[MEASURE]** (F1) to show the following page:



- Press the **[ZERO]** key before insert the probe in the chimney to zeroing the measured value.
- Insert the probe in the chimney. Check for mechanical positioning and flue gas intercepting. Wait for measurement stabilization.
- Press **[ENTER]** to memory store the pressure and draft values.
- Press **[ESCAPE]** (F1) to return to the previous page.

Now you can proceed with the Smoke index measurement and/or the gas analysis. The memory stored value will be printed together the analysis.

## 7.3.1 Burner pressure measurement

Using the burner pressure probe, it is possible to measure the pressure on the burner. Connect the probe to the instrument pressure input and connect to the burner plug. Follow the procedure described in paragraph 8.4 to read the pressure.

## 7.4 Smoke measurement

To avoid condensation inside the smoke pump, it should aspirate ambient air before the gas sample. This can be obtained aspirating the air by the fireside (not in the exhaust gas connection pipe) without using the paper filter. Introduce now the filter in the pump. The gas sample should be drawn to the center of the combustion gas flux. The correct gas volume is sampled with 10 uniform shoots by the pump.

Compare the darkening of the filter with the smoke index table. The smoke index found does not exceed the ones defined by the current normative.

We suggested to use a retaining cone during gas sampling.

**NOTE: IF YOU WANT TO PRINT THE SMOKE INDEX WITH THE ANALYSIS DATA, YOU SHOULD DO THE MEASUREMENT BEFORE THE FLUE GAS ANALYSIS.**

## 7.4.1 Input of the smoke index

Before input the data, you have to execute the smoke index measurements. You can input up to 3 values; the analyzer will do the average calculus.

- The smoke measurement requires the instrument in normal operating conditions indicating one of the measured or calculated parameters. Press **[SMOKE]** on the keyboard. The following page will be shown:

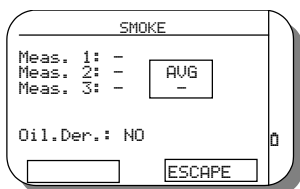

- Press **[▲]** and/or **[▼]** to move the cursor symbol to the “Measure 1” input field.
- Press **[ENTER]** to input the value. See instruction on paragraph 8.1.4.

If necessary, input the “Measure 2” and “Measure 3” smoke index. The instrument will compute the average.

- Press **[▲]** and/or **[▼]** to move the cursor symbol to the “Oil derivative”.
- Press **[ENTER]** to change the value for the correct fuel type.
- Press **[ESCAPE]** (F1) to return to the previous page without save the changes.
- Press **[ENTER]** to memory store the selection and return to the previous page.

## 7.5 Combustion air temperature (option)

It is important to measure the true combustion air temperature to have a correct boiler efficiency computation. The EGA4 has a auxiliary Rtd input to measure simultaneously the air temperature. A Pt100 with a 6 meters long cable can be connected on the right side of the analyzer.

Insert the Rtd inside the air combustion aspiration tube and near the boiler.

Follow the standard procedure to make measurements. The instrument will show the temperature on the display and the efficiency will be calculated using this value. If no external Rtd is connected, the analyzer will measure the instrument temperature (ambient) using the internal sensor.

## 7.6 Flow/Return temperature

Connect the thermocouple type K on the bottom of the instrument (the same connector used for gas temperature). If the temperature measurement is made using the contact method on the external side of the flow and return water pipe. In this case, we suggest to use an arch type thermocouple.

Press **[MENU]** to display the following page:

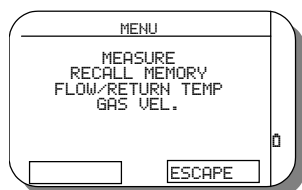

- Use **[▲]** and **[▼]** to move the cursor symbol to “T. Flow/Return” option
- Press the **[ENTER]** key to display the following page:

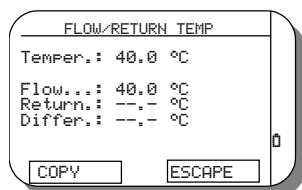



On the “Measure” field, the instrument will display the current temperature value measured using the connected thermocouple. The error message “Tc open” will be displayed if the thermocouple is not connected or broken. Positioning the thermocouple on the flow pipe.

- Use the [▲] and [▼] to move the cursor symbol to “T. Flow” field.
- Press [COPY] to copy the current temperature as T. Flow value.
- Press [ENTER] to manually change the temperature value

Positioning the thermocouple on the return pipe.

- Use the [▲] and [▼] to move the cursor symbol to “T. Return” field.
- Press [COPY] to copy the current temperature as T. Return value.
- Press [ENTER] to manually change the temperature value

The instrument will show the difference between the two values.

Press [ESCAPE] (F1) to return to the previous page. The temperature values will be printed on the ticket report.

## 7.7 Gas speed measurement

The **EGA4**, is arranged for chimney speed measuring. For this measurement you need a Pitot tube to be connected to the differential pressure inputs.

Connect the “+” terminal of the tube to “P1” connector and the “-” terminal the “P2” the instrument connector.

- Press [MENU] to display the following page:

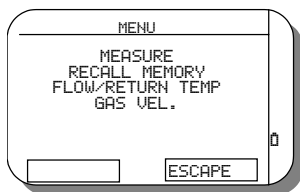

- Use the [▲] and [▼] keys to move the cursor symbol to “Gas Vel.” Option. Press the [ENTER] key.

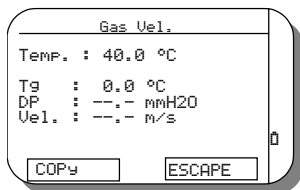

- Insert the gas probe in the chimney. Set the probe tip to the center of the pathway. The display will show the current gas temperature. An error message “Tc open” will be displayed if the thermocouple is not connected or broken.
- Use the [▲] and [▼] keys to move the cursor symbol to “Tg” parameter.
- Press [COPY] to copy the current temperature as Tgas value
- Press [ENTER] to manually change the gas temperature value

Extract the gas probe from the chimney. Insert the Pitot tube inside the chimney. Be care that the probe is parallel to chimney axis and facing burner.

- Use the [▲] and [▼] keys to move the cursor symbol to “ΔP” parameter.
- Press [COPY] to copy the current ΔP value.
- Press [ENTER] to manually change the ΔP value.

The instrument will display the gas speed.

Press [ESCAPE] to the previous page menu.

**NOTE: FOR THE BEST SPEED CALCULATION, DO NOT CHANGE THE BURNER RATE BETWEEN THE TWO MEASUREMENTS. THE OPTIMUM CONDITIONS WILL BE ACHIEVED USING 2 HOTELS IN CHIMNEY AND THE SIMULTANEOUS MEASUREMENTS**

## 7.8 Analysis data print

An internal impact printer can be installed as an option in the instrument. Read paragraph 8.10 for header report changing.

To print the report (ticket) of the analysis use the following procedure:

- Before make all measurements you need: Smoke index, pressure and draught, T. flow, etc. After make the gas analysis measurements and wait some seconds for measurement stabilizing. Press the **[PRINT]** key. The following page will be displayed:

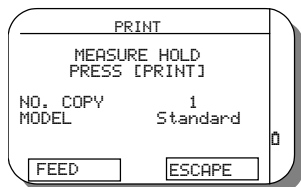

- Use the **[▲]** and **[▼]** keys to move the cursor symbol to "NO. copy" or "Model" field.
- Press the **[ENTER]** key to change the number of the reports you have to print and/or the print model for the report.
- Press the **[PRINT]** key again to print the report. You can abort the printing in progress by pressing the **[ESCAPE]** key.
- Press **[ESCAPE]** (F1) to abort the operation.
- Press **[FEED]** for paper advance. You can stop the paper advance by pressing the **[ESCAPE]** key.

### 7.8.1 Paper and Ribbon change

Open the cover pressing as in figure.



Extract the exhausted paper roll. You can use standard paper roll but you have to check before for its dimensions (max. 57mm  $\pm$ 1mm large and 48mm  $\pm$ 1mm roll diameter).

If necessary substitute the ribbon cartridge.

Approach the end of the new paper roll to the slot under the printer.

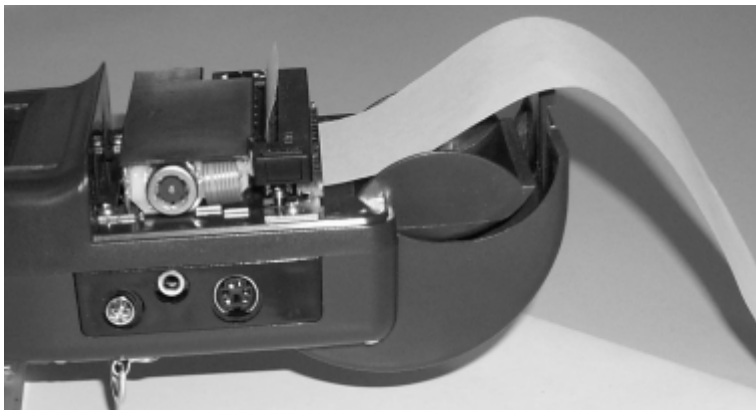

Switch the analyzer on.

Keeping the [HELP] key down; press the [▶] key to bypass the autozero procedure.

Press [PRINT] then press the [FEED] key for paper feed. Press the [ESCAPE] key when the paper will come out for same centimeters.

Close the cover inserting the paper end in its slot.

## 7.9 Pressure decay procedure (option)

This optional operative mode allows to find pipes leakage. To set and run leak test, press the [MENU] key from measuring page. The following page will be displayed:

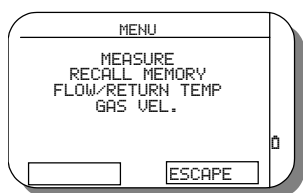

- Use the [▲] and [▼] keys to move the cursor symbol to "MEASURE" option.
- Press the [ENTER] key to select the option. Press [ESCAPE] (F2) to return to the previous menu.

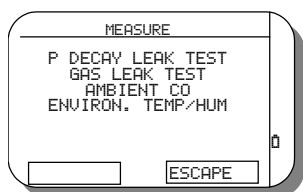

- Use the [▲] and [▼] keys to move the cursor symbol to "P DECAY LEAK TEST" option.
- Press the [ENTER] key to select the option. Press [ESCAPE] (F2) to return to the previous menu.

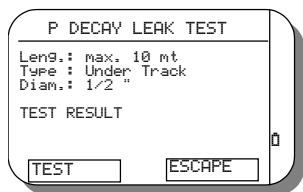

Before start the test you have to define the plant data:

**Leng.:** Length of pipes

**Type :** Type of plant (Under track or Visible)

**Diam.:** Pipes diameters (from 1/2" to 1 1/2" settable)

- Use the [▲] and [▼] keys to move the cursor symbol to the specification to be changed. Press the [ENTER] key to modify. Press [ESCAPE] (F2) to return to the previous menu.

- Use the [▲] and [▼] keys to move the cursor symbol to the value to be changed. Press the [ENTER] key to store the new selection.

Select “TEST RESULT” option for results viewing and press the [ENTER] key.

Now you can connect the instrument Pressure inlet (INP) connector to the gas circuit.

### CAUTION

**BE SURE FOR EMPTY AND CLEAN CIRCUIT: OVERPRESSURE, DUST, LIQUID AND CONDENSING MAY DAMAGE THE INSTRUMENT INTERNAL CIRCUITS.**

With circuit depressurized, press the [TEST] key. The unit will display the following page:

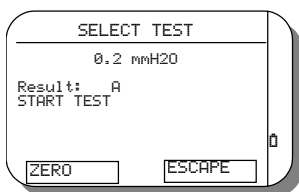

Press the [ZERO] key to reset the reading.

The 4000 series can memory store up to 2 different test data (A and B) for “Before” and “After” check.

- Use the [▲] and [▼] keys to move the cursor symbol to “Result” option. Press the [ENTER] key to select the option.
- Use the [▲] and [▼] keys to move the cursor symbol to the value to be changed. Press the [ENTER] key to store the new selection.

Select “START TEST” option and press the [ENTER] key to run the decay leak test.

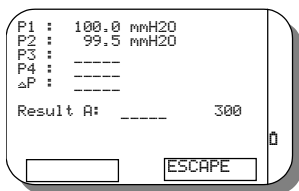

The unit will store 4 different measurements at programmed time (standard values are: 10, 60, 120 and 120 second). See paragraph 10.2.4 to change these values.

The instrument will display the ΔP (P1-P4) value and it compute, using the circuit specifications (Length, Diameter and Type) the test result (GOOD or FAIL).

Test result will be calculated using the following acceptance limits table:

Diameter [in]	Under track circuit					Visible circuit				
	1/2"	3/4"	1"	1" 1/4	1" 1/2	1/2"	3/4"	1"	1" 1/4	1" 1/2
<b>Length</b>										
< 10m	3.5	3	2.75	2	1.75	35	30	27.5	20	17.5
< 20m	2.85	2.35	2.2	1.4	1.1	28.5	23.5	22	14	11
< 30m	2.7	2.2	1.5	1.1	0.85	27	22	15	11	8.5
< 40m	2.35	1.7	1.2	0.9	0.4	23.5	17	12	9	4
< 50m	2.1	1.4	1.1	0.3	0.3	21	14	11	3	3
> 50m	1.85	1.4	0.9	0.3	0.3	18.5	14	9	3	3

Note: These values are expressed in mmH<sub>2</sub>O. The plant circuit is failed when (P1-P4) exceed the values after 5 minutes.

## 7.10 Ambient CO probe (option)

This optional external probe allows ambient CO monitoring for personnel safety. When connected to the analyzer, it monitor continuously CO concentration and it signal when the Long-term Exposure (TWA) limits are reached. An acoustic and visible signals are emitted by unit.

The following page show the current exposure limits for CO gas. This table is a guidance only, and figures must be checked before being used. Sensors used in safety applications should be fully calibrated at least every six months.

	U.K. HSE	GERMANY DFG	USA OSHA
TWA (8h)	50	30	35
STEL (10')	300	60 (30)	200

### 7.10.1 CO probe operations

To enable CO monitoring press the [MENU] key from measuring page. The following page will be displayed:

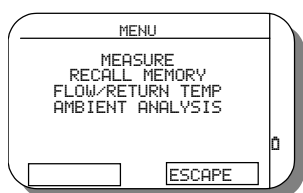

- Use the [▲] and [▼] keys to move the cursor symbol to “MEASURE” option.
- Press the [ENTER] key to select the option. Press [ESCAPE] (F2) to return to the previous menu.

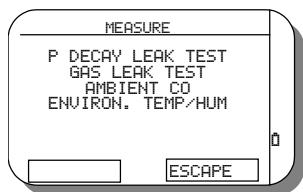

- Use the [▲] and [▼] keys to move the cursor symbol to “AMBIENT CO” option.
- Press the [ENTER] key to select the option. Press [ESCAPE] (F2) to return to the previous menu.

Connect the probe to the unit and wait for the following page:



**NOTE: WHEN PROBE IS CONNECTED THE INSTRUMENT BEGIN A 40 SECONDS WAITING TIME. IF PROBE IS CONNECTED IN AMBIENT CO MENU, A WAITING MESSAGE WILL BE DISPLAYED.**

Before insert the probe in working area, agitate it for same seconds in fresh and uncontaminated air. Press the [ZERO] key to reset the measure and start CO monitoring.

From this moment the unit will compare the monitored value with the CO limit (default OSHA limit: 35ppm). It is possible to change the CO limit using the GasConfig software for PC.

Press [ESCAPE] (F2) to return to the previous menu.

**NOTE: IF THE PROCEDURE ABOVE IS EXECUTED AND THE CO PROBE REMAIN CONNECTED, THE INSTRUMENT WILL MONITOR AMBIENT CO ALSO DURING OTHER OPERATIVE MODE.**

If alarm condition is marked, press the [ENTER] key to silence it.

## 7.11 Natural gas leak checker (option)

To enable natural gas monitoring press the [MENU] key from measuring page. The following page will be displayed:



- Use the [▲] and [▼] keys to move the cursor symbol to “MEASURE” option.
- Press the [ENTER] key to select the option. Press [ESCAPE] (F2) to return to the previous menu.

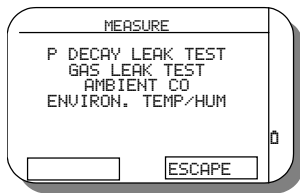

- Use the [▲] and [▼] keys to move the cursor symbol to “GAS LEAK TEST” option.
- Press the [ENTER] key to select the option. Press [ESCAPE] (F2) to return to the previous menu.

Connect the probe to the unit and wait for the following page:

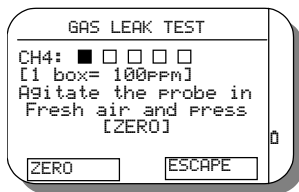

**NOTE: WHEN PROBE IS CONNECTED THE INSTRUMENT BEGIN A 60 SECONDS HEATING TIME. IF PROBE IS CONNECTED IN “GAS LEAK TEST” PAGE, A WAITING MESSAGE WILL BE DISPLAYED.**

Refer to paragraph 10.2.3 to change the 60 sec. heating time.

Before insert the probe in working area, agitate it for same seconds in fresh and uncontaminated air. Press the [ZERO] key to reset the measure and start CH<sub>4</sub> monitoring.

From this moment the unit will compare the correct CH<sub>4</sub> reading. Pressing the [▶] key you can change the probe range to 500ppm/box. Pressing the [◀] key you can return to 100ppm/box range.

Eclipse suggest to use 100ppm/box for ambient gas checking and 500ppm/box for pipe gas leak testing.

After zeroing, the boxes will fill proportionally with the reading and an intermittent sound advise the operator for gas concentration as shown in the following table:

- 1 box = 1 beep/sec
- 2 box = 2 beeps /sec
- 3 box = 3 beeps /sec
- 4 box = 5 beeps /sec
- 5 box = continuous beep

Press [ESCAPE] (F2) to return to the previous menu.

## 7.12 Temperature & Humidity probe (option)

To enable temperature and relative humidity monitoring press the [MENU] key from measuring page. The following page will be displayed:

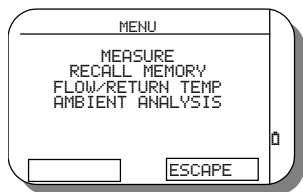

- Use the [▲] and [▼] keys to move the cursor symbol to “MEASURE” option.
- Press the [ENTER] key to select the option. Press [ESCAPE] (F2) to return to the previous menu.

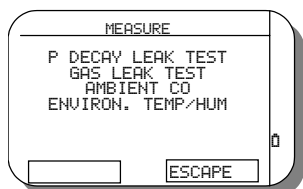

- Use the [▲] and [▼] keys to move the cursor symbol to “ENVIRON. TEMP/HUM” option.
- Press the [ENTER] key to select the option. Press [ESCAPE] (F2) to return to the previous menu.

Connect the probe to the unit and wait for the following page:

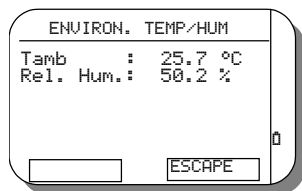

**NOTE: WHEN PROBE IS CONNECTED THE INSTRUMENT BEGIN A 40 SECONDS WAITING TIME. IF PROBE IS CONNECTED IN “ENVIRON. TEMP/HUM” PAGE, A WAITING MESSAGE WILL BE DISPLAYED.**

Press [ESCAPE] (F2) to return to the previous menu.

## 8 MEMORY MANAGEMENT

The standard configuration include an internal memory to store up to 250 complete gas analysis divided by Tags (max. 40 tags). Each analysis includes 10 gas concentration values, data and time. Each Tag includes one or more analysis data, 16 characters ID, 3 rows for the Customer data, Draught and smoke index values, Water temperatures, etc. An optional PC compatible PCMCIA internal adapter can be installed for memory extension.

Press the [STORE] key to store, delete and assign the Tag for the current analysis. The following option will be displayed:

**STORE**  
**TAG SELECTION**  
**DELETE MEMORY**

- Use the [▲] and [▼] keys to move the cursor symbol to the desired option.
- Press the [ENTER] key to select the option.

**NOTE: BEFORE STORE OR DELETE THE MEMORY YOU MUST SELECT THE TAG IF IT IS DIFFERENT FROM THE CURRENT.**

### 8.1 Store data analysis

If you had pressed the [ENTER] key with the cursor on the “STORE” option, the analyzer will display the following message:

**WAIT ... storing in process**

The analysis data will be memory stored in the current Tag and you can display or print all data when you need it.

### 8.2 Delete memory

If you had pressed the [ENTER] key with the cursor on the “DELETE MEMORY” option, the analyzer will display the following message:

**!! ATTENTION !! The memory will be deleted when you press [DELETE]**

If you press the [DELETE] key (F1), The analysis data will be deleted.

### 8.3 Recall memory

When you have stored the analysis data, you can recall the measured values by pressing the [MENU] key. The following page will be displayed:

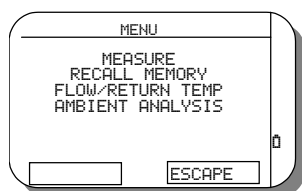

- Use the [▲] and [▼] keys to move the cursor symbol to “RECALL MEMORY” option.
- Press the [ENTER] key to select the option.
- Press [ESCAPE] (F1) to return to the previous menu.



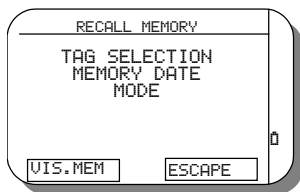

**NOTE:** BEFORE RECALL THE MEMORY YOU MUST SELECT THE TAG IF IT IS DIFFERENT FROM THE CURRENT, SELECT THE READING MODE: SINGLE OR AVERAGE AND SELECT THE STORED DATA.

Press **[VIS.MEM]** (F1) to visualize the analysis data: the selected memory data or the average values of the selected Tag. Press **[PRINT]** (F2) to print the report for the displayed data.

To change the recalling mode follow the procedure below:

- Use the **[▲]** and **[▼]** keys to move the cursor symbol to "MODE" option.
- Press the **[ENTER]** key to select the option.
- Use the **[▲]** and **[▼]** keys to move the cursor symbol to "Single" or "Average" mode.
- Press the **[ENTER]** key to select the option.
- Press **[ESCAPE]** (F1) to return to the previous menu without save the selection.

To change the memory date follow the procedure below:

- Use the **[▲]** and **[▼]** keys to move the cursor symbol to "MEMORY DATE" option.
- Press the **[ENTER]** key to select the option.
- Use the **[◀]** and **[▶]** keys to display the date/time for all current Tag memory.
- Press the **[ENTER]** key to select the option.
- Press **[ESCAPE]** (F1) to return to the previous menu without save the selection.

## 8.4 DBGas 2000

**DBGas 2000** is a PC Windows 95/98/NT compatible program to manage all checks and measures activities on boilers and to transfer data from and to Eclipse Gas analyzers. The software is designed for a complete and efficient managing and recording of the analysis data of your clients. **DBGas 2000** allows you to have a no limits database on your PC with all customer and boiler information, to select up to 40 boiler to be check, to assign an operator name and transfer the data to the analyzer. The operator will memory store up to 250 boiler checks and print the report; after the analysis he can transfer the data to the PC. The software will assign the analysis to the correct boiler in the database. Operator can view and print the data until he delete these.

The main menu is made by 4 buttons: Plants/Clients, Analysis, Fuels and Exit from program.



### 8.4.1 Plants/Clients menu

Selecting this option, you can manage the customers, boilers and plants information database and it is possible to transfer this data from the PC to the analyzer. For each plant can be assigned the customer personal data (name, address, phone and fax numbers, etc.) and one or more boiler information (name, type, fuel, etc.).

Database is organized as a two separate tables: Plants/Clients database and Boilers installed.

Selecting one plants on the upper table, the lower table will show you the boilers installed on that plant.

All data can be changed easily by made a click with the mouse pointer on the cell. You can input the new data on the blank row (the last one) for adding a new boiler or new plant record. To delete a boiler or a plant you have to select it with a click and press the "Delete" key on PC keyboard.

To have a more readable database, you can reduce, enlarge or hide the columns; approach the mouse pointer to the right limit of the cell to be reduce (enlarged), pressing the right button move the mouse to the left (right). By pressing two time quickly the left mouse button on the column, this will be automatically adapted to the pre-set dimensions. All changes will be saved when you exit from the program.

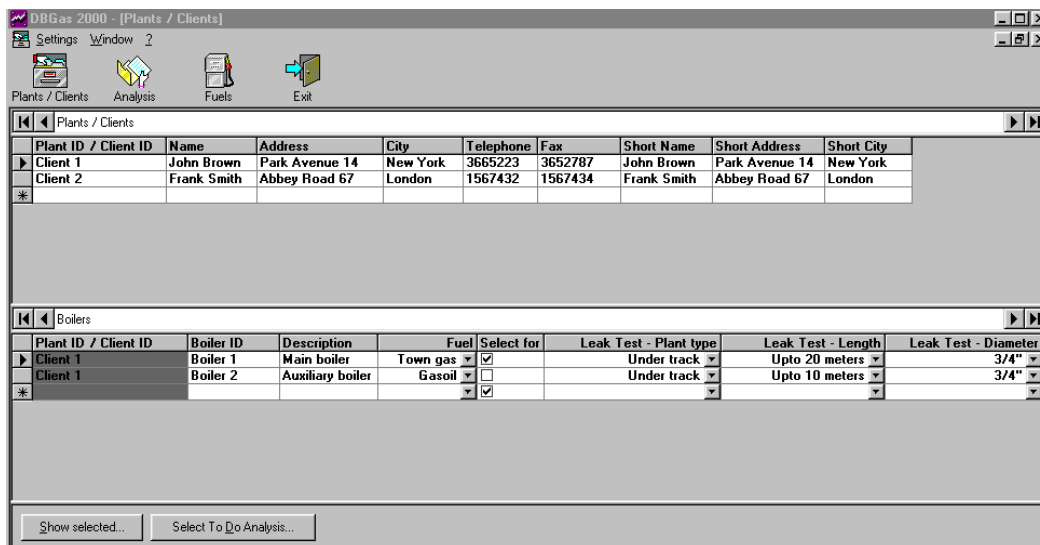

When database is complete, you can select up to 40 boilers on the table for data transfer by selecting the “Select for data transfer” column. Pressing the “Select to Do Analysis”, you can select in automatic mode all analysis made by more than “XX” months.

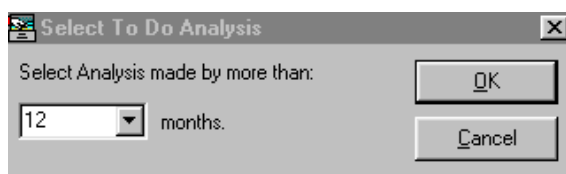

Pressing the “Show selected” button, the program will show all boiler selected for data transfer.

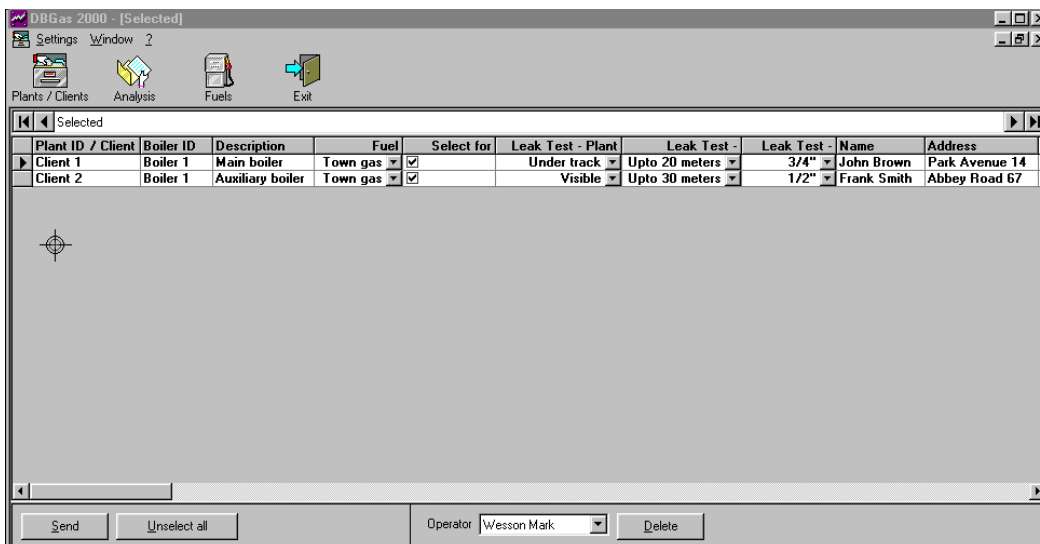

You can exclude manually one or more boiler from the list. Select or input the operator name, connect the IR to RS232 adopter to the PC, approach the IR terminal to the analyzer IR communication windows, and press the “Send” button to send the data to the analyzer.



## 8.4.2 Analysis menu

This option is the main part of the program. You can transfer the analysis data from the analyzer to the PC, save and manage it using a database structure, display and export the data in Microsoft Excel™ compatible format.

The analysis window is made by 3 tables: plant and customer information, boiler information for the selected plant and analysis groups data for the selected boiler.

The analysis groups data will be ordered by data and will show the general data for the group of measurements (smoke indexes, T flow and return, etc.).

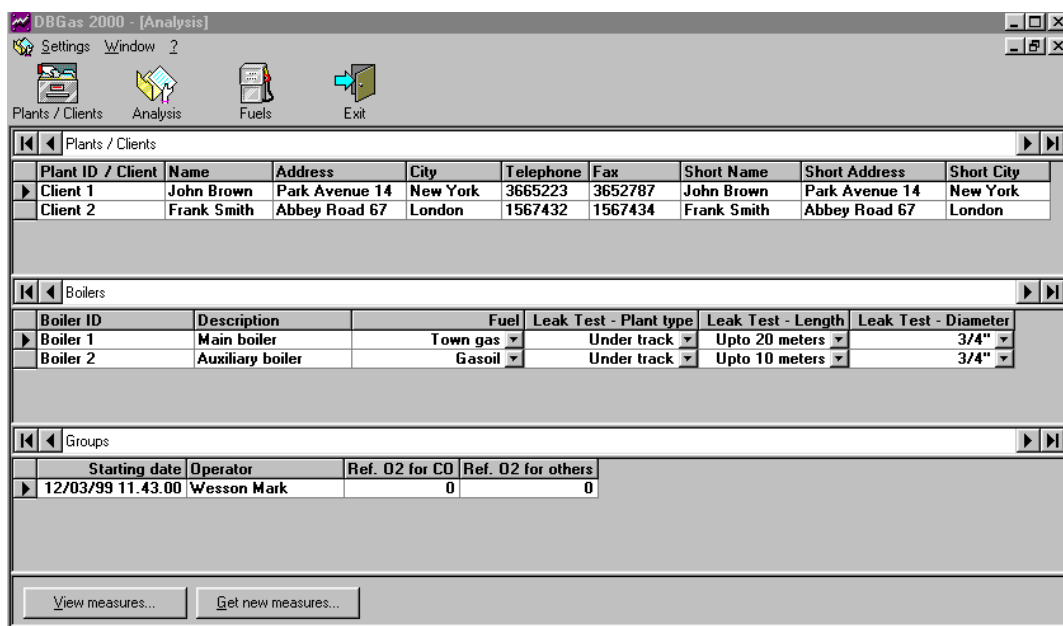

Select by mouse the Plant, Boiler and Group to be displayed. The arrows on the left column on the tables will show you the current record. Pressing the "View measure" button you can read the single data measurements for the selected group (contents of gas, temperatures, pressure/draught, efficiency, smoke index, etc).

Flow Temp [°C]	Return Temp [°C]	Smoke Average	Oil derivative	Leak Result A	Leak Result B	Leak Test A P1	Leak Test A P2
No measure	No measure	-	No	-----	-----	No measure	No measure

  

Sampling date	O2 [%]	CO [ppm]	NO [ppm]	Tgas	Tamb	Tdiff [°C]	Draught [hPa]	CO2 [%]	EoA 1	EoA 2 [%]	Eff. nett [%]	Eff. gross [%]
12/03/99 11.43.00	5,5	0	1	107,6	23,4	84,2	No measure	7,7	1,32	31,9	93,7	93,7
12/03/99 11.46.00	5,5	0	1	106,2	23,4	82,8	No measure	7,8	1,32	31,5	93,8	93,8
12/03/99 11.47.00	5,6	0	1	107,3	23,4	83,9	No measure	7,7	1,32	32,1	93,7	93,7
12/03/99 11.47.00	5,5	0	1	107,4	23,4	84,0	No measure	7,7	1,32	31,7	93,7	93,7
12/03/99 11.48.00	5,5	1	1	106,3	23,4	82,9	No measure	7,7	1,32	32,0	93,8	93,8
12/03/99 11.48.00	6,1	0	1	107,2	23,4	83,8	No measure	7,5	1,36	36,2	93,5	93,5
12/03/99 11.48.00	5,5	0	1	106,0	23,4	82,6	No measure	7,7	1,32	31,8	93,8	93,8
12/03/99 11.48.00	5,5	0	1	106,1	23,4	82,7	No measure	7,7	1,32	31,7	93,8	93,8
12/03/99 11.49.00	6,1	0	1	106,1	23,4	82,7	No measure	7,5	1,36	36,4	93,6	93,6
12/03/99 11.49.00	6,0	0	1	106,3	23,4	82,9	No measure	7,5	1,36	35,9	93,6	93,6
-----	5,68	0,1	1,0	106,65	23,40	83,25	-----	7,65	1,332	33,12	93,70	93,70

The operator can change the measuring units, the fuel type, etc. The program will make the conversion in real time and will display the new values.

A set of 4 buttons allows you to set the printer, to print measures, export measures using an Excel compatible format, show or hide the columns.

A fifth button is normally disabled and it allows to display graphics. To display graph, you have to select one or more columns for graphics. Select the column by positioning the mouse pointer on the desired column header and click, using the mouse left button; click using the mouse right button and select the "Select for graph" option. The column header will be displayed in *Italic*. The "Show graph" button became active. You can display the graph by pressing the "Show graph" button.

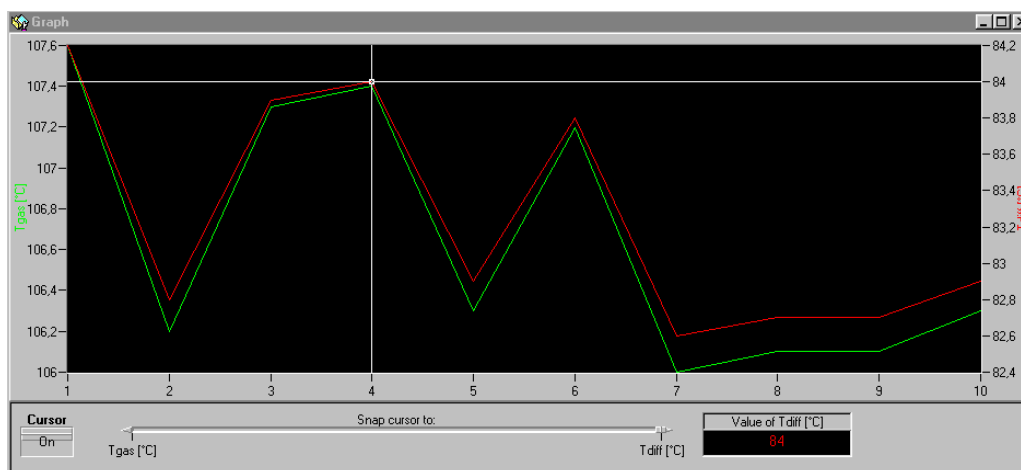

Activate the cursor and snap cursor to the desired parameter. Using the mouse you can move the cursor amongst the measure.

## 8.4.3 Fuels menu

You can read from the analyzer all data parameters for the stored fuels. Press the "read from instrument" button to transfer, using the IR interface, the fuel data from the analyzer.

The screenshot shows a window titled 'Fuels' with a tabbed interface. The first tab is selected. The window contains the following fields and values:

#1	#2	#3	#4	#5	#6	#7	#8	#9
Fuel name: Town gas								
K <sub>1</sub> /K/A/C		0,5800		K <sub>net</sub>		0,000		
K <sub>2</sub> /B/D		0,0000		H		0,0		
K <sub>L</sub>		0,89		mH <sub>2</sub> O		0,0		
CO <sub>2</sub> MAX		10,5		Q <sub>gross</sub>		0,00		
EGJ		0,2304		Q <sub>net</sub>		0,00		
K <sub>gross</sub> /HI-Hg		0,0000		Formula type		Siegertsche		

Buttons at the bottom: 'Get from instrument' and 'Close'.

**NOTE:** THE FUEL DATA TRANSFER FROM ANALYZER SHOULD BE MADE AFTER THE PROGRAM INSTALLATION OR IF THE FUEL DATA CHANGES ON THE ANALYZER.

### IMPORTANT

TO CHANGE OR ADD NEW FUELS DATA, YOU HAVE TO USE GASCONFIG SOFTWARE. THE INSTRUCTIONS ARE SHOWN ON 9.2 PARAGRAPH.

## 8.4.4 DBGas 2000 Installation

**DBGas 2000** runs on IBM PC under WINDOWS 95/98/NT. Minimum requirements are a Pentium CPU with 16Mbyte Ram and 20 Mbyte on hard disk, a color monitor and a Microsoft mouse or a compatible one.

In order to install **DBGas 2000** for Windows, follow the below procedure:

- Place the **DBGas 2000** disk in a CD-ROM drive;
- From the Windows Start Menu, select **<RUN>**;
- Enter the filename D:SETUP.EXE (substitute the letter D for the disk drive that contains **DBGas 2000** disk)
- Follow the on screen instructions making sure to provide the correct path to your **DBGas 2000** directory when prompted.

Once installed, the **DBGas 2000** icon will appear on your Windows screen and it will be possible to boot it by clicking on the icon as usual.

## 8.5 Configuration Software

**GasConfig** software is a PC windows compatible program for configuring the EGA4 flue gas analyzers. You can change all memory settings: displayed measurements pages, printed measurements layout, Alarms, Fuels coefficients, measuring technical units, etc.

### 8.5.1 How operate using GasConfig

When you run **GasConfig** a 2 independent windows system will be displayed on the PC monitor.

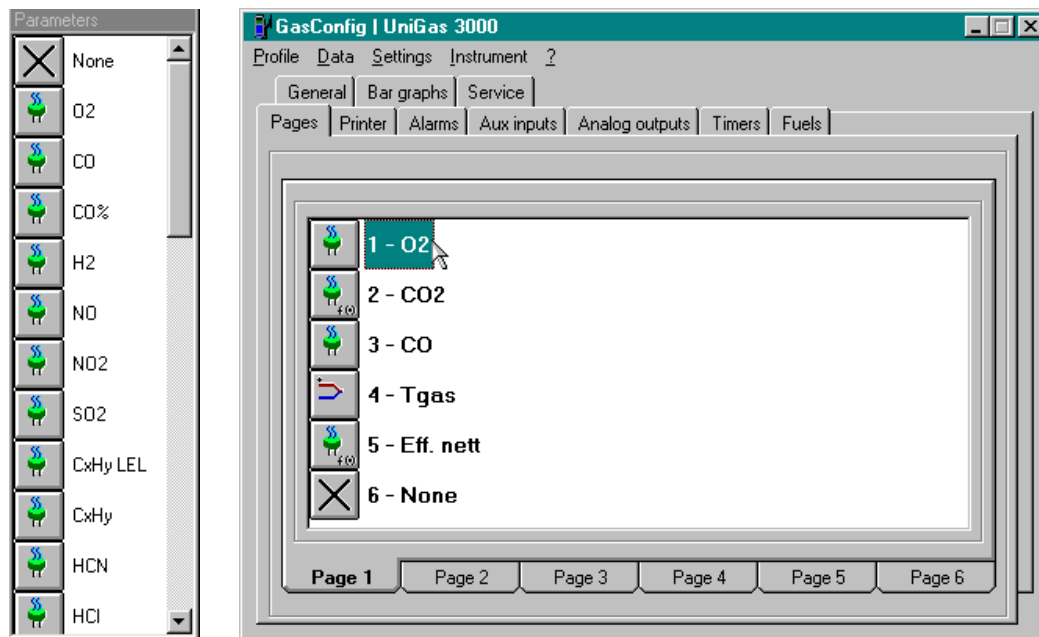

The window on the left is a parameter icon list. This list show all possible parameters for measured (O<sub>2</sub>, CO, Tgas, Draught, etc.) and calculated measures (CO<sub>2</sub>, Efficiency, etc.). Same of these can be not available in your instrument (it depends by instrument model, installed cells, and options).

The window on the right is the program user interface. It is organized in function pages; you can select the page for interesting parameters using the mouse.

A main menu bar allows you to load and save the configuration data, to change communication setting, for data transfer from and to the analyzer.

#### WARNING

**BEFORE CONFIGURATION DATA TRANSFER FROM AND TO YOUR PC, BE SURE TO HAVE SELECTED THE EGA4 UNIT USING THE "INSTRUMENT" OPTION ON MAIN MENU BAR.**

The available function pages are:

- General** This page allows you to set the general parameters as engineering units, O<sub>2</sub>% reference values, etc.
- Pages** You can set up to 6 different pages in your instrument to display up to 36 different measured and calculated values.
- Printer** You can program the complete layout for report printing: header, measured parameters, etc.

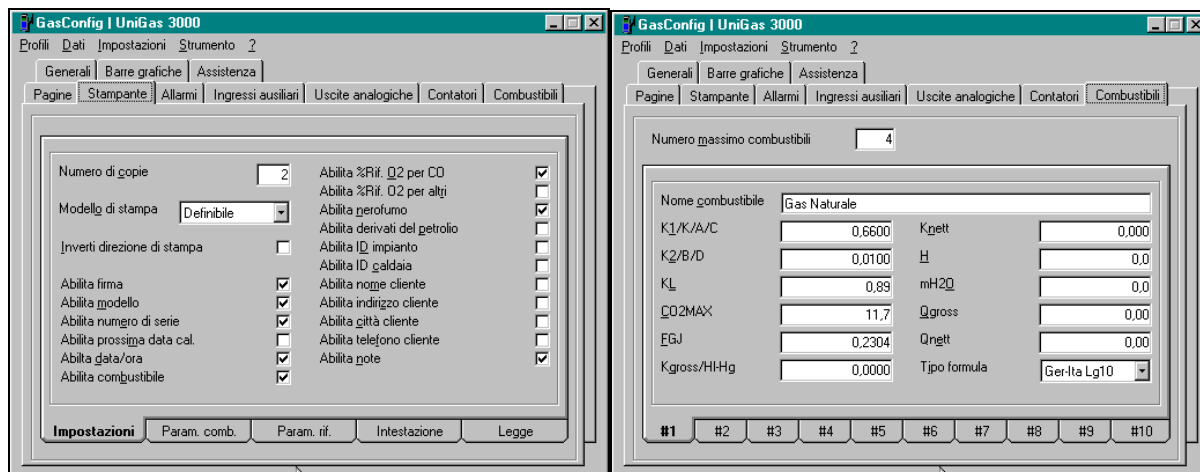

- Alarms** You can enable, disable, and program up to 4 different acoustic and visible alarms for critical measurements.
- Aux Inputs** Not available for software version 1.001
- Analog Output** Not available for software version 1.001
- Timer** You can change the autozero time and the leak decay time.
- Fuels** Up to 10 different fuels coefficient tables can be programmed.
- Bar graphs** You can set up to 6 different bargraph (parameter and range).
- Service** 3 services information lines can be programmed for factory co-ordinates. (We suggest to have Eclipse telephone and fax numbers).

## 8.5.2 GasConfig Installation

Software runs on IBM PC under WINDOWS 95/98/NT operative systems. Minimum requirements are a Pentium CPU with 16Mbyte Ram and 8 Mbytes on hard disk, a color monitor and a Microsoft mouse or a compatible one. In order to install the Software for Windows, follow the below procedure:

- Place the Software disk in a CD-ROM drive;
- From the Windows Start Menu, select **<RUN>**;
- Enter the filename D:SETUP.EXE (substitute the letter D for the disk drive that contains Software disk)
- Follow the on screen instructions making sure to provide the correct path to your Software directory when prompted.

Once installed, the **EGA4 Configuration Software** icon will appear on your Windows screen and it will be possible to boot it by clicking on the icon as usual.

## 9 CONFIGURATION

Many parameters can be modified using the instrument keyboard. Pressing the **[SETUP]** key, you can change the current fuel, include or exclude the CO cell, change the technical unit, set the alarms, etc. The

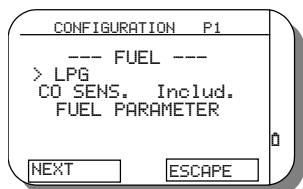

- press **[NEXT]** to change menu page

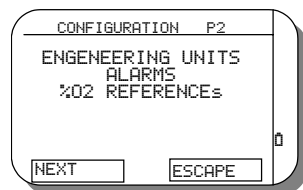

- Use the **[▲]** and **[▼]** keys to move the cursor symbol to the desired option.
- Press the **[ENTER]** key to select the option.
- Press **[ESCAPE]** (F1) to return to the previous menu.

<b>Fuel</b>	You can select between the pre-set fuel table (LPG, Diesel oil, Oil, Natural gas) or, if programmed using the configuration PC software, 6 customizable.
<b>CO cell</b>	If the CO electro-valve option is installed, you can Include, exclude or automatically select (using the PC configuration software, you can program the CO level for automatic exclusion) the CO cell.
<b>Fuel Parameters</b>	You can display only all the constant table for the selected fuel. To change the values, you should use the configuration PC software.
<b>Engineering Unit</b>	You can change the technical units for gas, temperature and pressure measurements.
<b>Alarms</b>	You can set the alarms levels, Min/Max operation and enable/disable all the 4 possible acoustic and visible alarms.
<b>%O2 references</b>	You can set the %O2 for CO measurements and %O2 for other gas.

### 9.1 Engineering Units

When you select the Engineering unit option, the following page will be displayed:

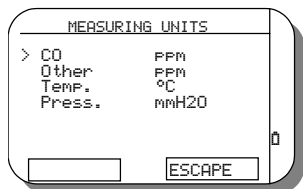

- Use the **[▲]** and **[▼]** keys to move the cursor symbol to the desired option.
- Press the **[ENTER]** key to change the value.
- Press **[ESCAPE]** (F1) to return to the previous menu.

The measuring units selectable for gas are: ppm, mg/m<sup>3</sup>, mg/kWh, g/GJ.

The measuring units selectable for temperature are: °C, °F.

The measuring units selectable for pressure are: hPa, mbar, mmH<sub>2</sub>O, inH<sub>2</sub>O.

### 9.2 Alarms



When you select the Alarms option, the following page will be displayed:

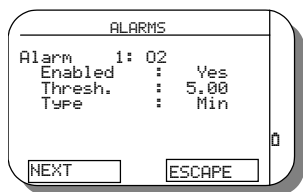

- Use the [▲] and [▼] keys to move the cursor symbol to the desired option.
- Press the [ENTER] key to change the value.
- Press [ESCAPE] (F1) to return to the previous menu.
- Press [NEXT] (F1) to display the next alarm page. Up to 4 alarms can be set for different gas type and levels.

**NOTE:** THE REFERENCE GAS FOR ALARMS ARE PROGRAMMED IN FACTORY. THE GAS TYPE CAN BE CHANGED ONLY USING THE OPTIONAL PC CONFIGURATION SOFTWARE.

When the measured value became in alarm band, a continuous sound (beep) inform you the condition. Simultaneously, the parameter will be displayed in the measuring page in reverse mode. You can acknowledge the alarms pressing the [ENTER] key. In this case the beep will stop but the reverse mode remain.

## 9.3 HELP key

Help menu inform of the instrument status (electrochemical cells status and battery level), Service information and allows you to change the header printer text.

When you select this option, the following page will be displayed:

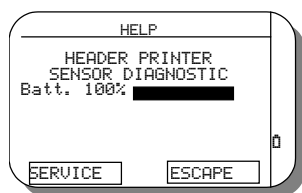

Press [ESCAPE] (F2) to return to the previous page.

### 9.3.1 Header setting

The "HEADER PRINTER" option, allows you to set 4 rows of 16 characters for report header printing.

Press the [ENTER] key when the cursor symbol is positioned near the menu option. The following page will be displayed:

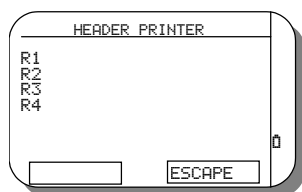

Select the R1, R2, R3, and R4 rows and press [ENTER] to insert or change the text. Press [ESCAPE] (F2) to return to the previous page.

### 9.3.2 Sensor Diagnostic

The "SENSOR DIAGNOSTIC" option, allows you to read the actual status for the inserted cells.

Press the [ENTER] key when the cursor symbol is positioned near the menu option. The following page will be displayed:

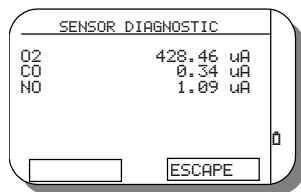

Press **[ESCAPE]** (F2) to return to the previous page.

### 9.3.3 Service Data

The "SERVICE" option, allows you to read the information to contact us for service assistance and the information that we want to know for identify your instrument configurations: instrument configuration code and serial number, firmware version, etc.

Press the **[SERVICE]** (F1) to display the following page:

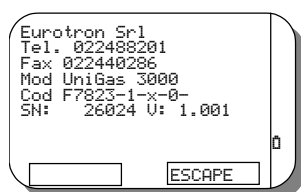

Press **[ESCAPE]** (F2) to return to the previous page.

## 10 MAINTENANCE

The **EGA4** analyzer has been developed and manufactured using high quality components. A correct, systematic maintenance will prevent damage and will increase substantially the life of the instrument, giving excellent results. Anomalous conditions that require extraordinary maintenance interventions are promptly displayed, either clearly or with an information code.

### 10.1 Error messages

The instrument performs the autodiagnostic procedure when switched on. When measuring it checks also for anomalous conditions. If analyzer finds trouble, it display a message on LCD. Sometime these messages corresponds to a unrecoverable problem and it is necessary to return the instrument to Eclipse for maintenance. Frequently these message are referred to a recoverable trouble and can be solved by yourself.

The following table show the possible instrument error messages:

Error message	Problem	Solutions
Calc Err	Parameter calculus error.	The instrument cannot perform the calculus. Check and solve the others error conditions.
Probe Er	The external Rtd probe is unconnected or damaged.	Connect or replace the external temperature probe.
RJ Err	Internal temperature reference damaged.	Return the instrument to Eclipse for maintenance
Over	Overrange condition	The problem is solved automatically when measure return inside the range
Under	Underrange condition	The problem is solved automatically when measure return inside the range
-----	No calculus available	The instrument cannot perform the calculus. Check and solve the others error conditions. (e.g. O <sub>2</sub> >18%).
Excluded	CO sensor excluded by electro-valve	Automatic CO sensor protection is active. Perform one or more autozero cycle in fresh air.
To Error	The thermocouple is unconnected or damaged.	Connect or replace the temperature probe.
Tsens Er	Cell compensation error	Return the instrument to Eclipse for maintenance.
Zero Err	The autozero procedure is failed	Perform one or more autozero cycle in fresh air. If the problem remain, Return the instrument to Eclipse for maintenance.
Sens. Er	Broken cell	Return the instrument to Eclipse for maintenance.
No meas.	Empty Memory	
No sens.	The cell is non installed	
No probe	No external probe connected on mini-din connector.	Connect or replace the temperature probe.

### 10.2 Set-up menu

Configuration menu is protected by a password. This procedure menu allows the operator to change some internal parameters values: Date and time internal clock, communication baud rate, autozero time and leak test timing.

Follow the procedure below to activate the procedure:

- Switch the instrument off

- Press and maintain the **[SETUP]** key down; press the **[ON/OFF]** key.
- The analyzer will switch on. A password input page will displayed. Insert the password code “0011” and press the **[ENTER]** key. The following page will displayed:

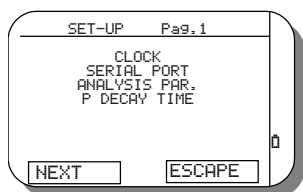

- Press the **[NEXT]** (F1) key to change menu page.

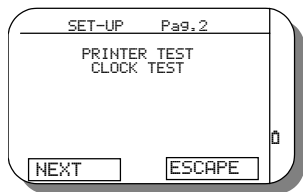

- Use the **[▲]** and **[▼]** keys to move the cursor symbol to the desired option.
- Press the **[ENTER]** key to enter in the option set-up page.
- Switch the instrument off to exit from the configuration procedure

## 10.2.1 Clock

Select this option for date and time set-up. Verify that the current values are corrects because the analyzer use these data for analysis storing.

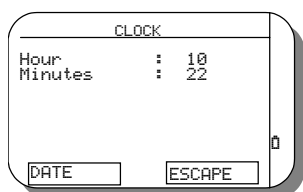

- Use the **[▲]** and **[▼]** keys to move the cursor symbol to the desired option.
- Press the **[ENTER]** key to enter in the option set-up page.
- Press **[ESCAPE]** (F2) to return to the previous menu.
- Press **[DATE]** (F1) to change date.



- Use the **[▲]** and **[▼]** keys to move the cursor symbol to the desired option.
- Press the **[ENTER]** key to set a new date or date format (European or USA).
- Press **[ESCAPE]** (F2) to return to the previous menu.
- Press **[TIME]** (F1) to change time.

## 10.2.2 Serial Port

Selecting this option, you can set the baud rate and the ID number for instrument in infrared serial communication.

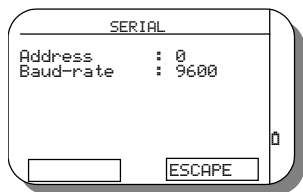

- Use the [▲] and [▼] keys to move the cursor symbol to the desired option.
- Press the [ENTER] key to set a new ID number or baud rate.
- Press [ESCAPE] (F2) to return to the previous menu.

## 10.2.3 Analysis

Selecting this option you can change the analyzer auto-zeroing time and CH<sub>4</sub> & Natural gas heating probe time (we suggest to use the pre-set values of 180 sec for autozero time and 60 sec for CH<sub>4</sub> heating time).

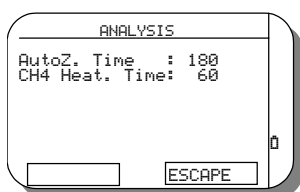

- Use the [▲] and [▼] keys to move the cursor symbol to the desired option.
- Press the [ENTER] key to set a new Auto-zero time.
- Press [ESCAPE] (F2) to return to the previous menu.

## 10.2.4 Leak test time

Selecting this option, you can change the timing for leak test using the decay method. The test has a total period of 310 seconds and the programmable time represent the interval between the measurements.

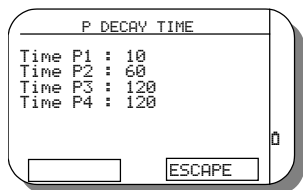

- Use the [▲] and [▼] keys to move the cursor symbol to the desired interval.
- Press the [ENTER] key to set new acquisition intervals.
- Press [ESCAPE] (F2) to return to the previous menu.

## 10.3 Firmware Upgrade

In order to upgrade the firmware of the instrument proceed as follows:

- 1 - Install the ST167Flash program from the CD.
- 2 - Connect the infrared interface adapter to the serial port of the PC with the supplied cable (note back the serial port used: COM1 , COM2 or other).
- 3 - Position the interface near the right side of the instrument.
- 4 - Run the ST167Flash program you have installed.
- 5 - Select the same serial port that you noted back.
- 6 - Select the Baud rate to 115200 Baud (if the PC owns an UART 16550 type), otherwise select a lower Baud rate.
- 7 - Press the three dotted button in order to load the firmware file (.HFW extension) normally located on a 3 1/2" diskette. A version number of the firmware being discarded is shown in the dedicated field.
- 8 - From instrument OFF press and continue to press the F1 key while pressing the ON/OFF key in order to set the instrument in firmware upgrade status.
- 9 - Click on the 'Program' button to start the upgrading phase and wait until a termination message appears.

**NOTE: IF DATA TRANSFER FAILS, PLEASE TURN OFF THE INSTRUMENT AND REPEAT THE PROCEDURE FROM STEP 8.**

## 10.4 Smoke pump maintenance

### Gas-tight checking

To have a correct measurement the pump should be gas-tight. Turn the screw and close the probe with your finger. Pull the plunger for 3 cm and verify that the gasket does not leak the vacuum. If a leak is found the gasket needs to be lubricated. When you push the plunger the valve must close immediately to have a 1.9/2.0 litres of air with 10 shoots. The correct smoke index can be obtained only if the pump works correctly.

### Service

1. Clean and lubricate the cylinder, the stem and the gasket every 30 measurements.
2. Wash using alcohol if the valve is not gas-tight
3. Clean the probe and the paper support
4. Check the pump for gas-tight
5. Use only clean paper filters and a readable scale index table

## 11 CERTIFICATES

### 11.1 Warranty terms

Each instrument is shipped with a Warranty Certificate that indicates the validity conditions of the warranty itself. **Eclipse** warrants its products against defects in materials and workmanship.

If the unit should malfunction, it must be returned during the warranty period, transportation prepaid, to **Eclipse** for evaluation. Upon examination, if the unit is found to be defective it will be repaired or replaced at no charge.

**Eclipse's** WARRANTY does not apply to defects resulting from any action of the purchaser, including but not limited to mishandling, improper interfacing, operation outside of design limits, improper repair, or unauthorized modification. This WARRANTY is VOID if the unit shows evidence of having been tampered with or shows evidence of being damaged as a result of excessive corrosion; or current, heat, moisture or vibration; improper specification; misapplication; misuse or other operating conditions outside of **Eclipse's** control.

This warranty applies to the original purchaser only. Please include a copy of the original invoice or a small service charge may be applied.

Direct all warranty and repair requests/inquiries to the **Eclipse** Customer Service Department. BEFORE RETURNING ANY PRODUCT(S) TO **ECLIPSE**, PURCHASER MUST OBTAIN AN AUTHORIZED RETURN (AR) NUMBER FROM **ECLIPSE'S** CUSTOMER SERVICE DEPARTMENT (IN ORDER TO AVOID PROCESSING DELAYS).

The purchaser is responsible for shipping charges, freight, insurance and proper packaging to prevent breakage in transit.

### 11.2 Letter of conformity

Each instrument is shipped with a Letter of Conformity, to grant that the characteristics of the instrument correspond to the required ones, and that the instrument calibration is traceable to the National and International Standards.

## APPENDIX

### A1 Example

The following steps show how you can make a quick measurement using the EGA4 portable analyzer.

1. Switch **EGA4** on. It will begin the autozero and the autodiagnostic procedure. System error and trouble will be displayed if encountered.

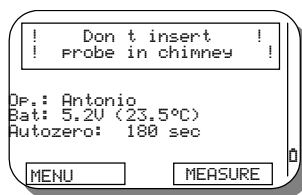
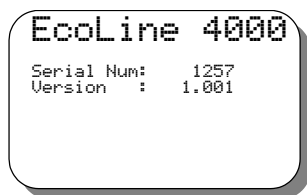

2. Select the combustible used by burner. It is possible choosing between 4 preset and other 6 customizable types.

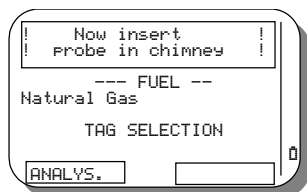

3. Connect the sampling probe electrical and pneumatic terminals to the **EGA4**.
4. Insert the sampling probe in chimney. Be sure for mechanical positioning and flue gas intercepting.
5. Press **ANALYSIS**] (F1) key to start the measurements. Select the desired data page using [▲] and [▼] keys. Zoom in or out to enlarge or reduce the visualized characters using the [▶] and [◀] keys.

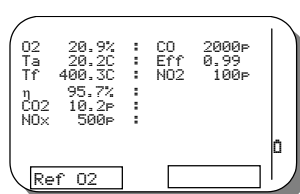
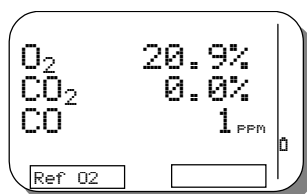

6. Finishing measurement procedure, press the **[PRINT]** key to print one or more reports.

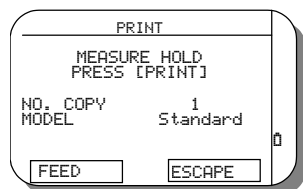

7. Dismount the system and switch it off. All system can be put back in a rugged and practical case.



## INDEX

- A**
- Accuracies and ranges; 7
  - Alarms; 40
  - Ambient CO probe; 29
  - Ambient CO probe; 6; 9
  - Ambient T+RH\_probe; 6
  - Analysis; 45
  - Analysis data print; 25; 26
  - Analysis menu; 35
  - APPENDIX; 48
  - Auxiliary measure; 13
- B**
- Barcode pen reader; 9
  - Basic operation; 18
  - Built-in printer; 8
  - Burner pressure probe; 9
- C**
- Calibration certificate; 9
  - CERTIFICATES; 47
  - change page; 19
  - Clock; 44
  - CO probe operations; 29
  - Combustion air temperature; 24
  - ConfGas Installation; 39
  - CONFIGURATION; 40
  - Configuration Software; 38
  - CONNECTIONS; 16
  - Contrast; 19
- D**
- DBGas 2000; 33
  - DBGas 2000 Installation; 37
  - Delete memory; 32
  - Display; 8; 18
  - Display regulation; 19
- E**
- Electro-pneumatic connections; 16
  - Error messages; 43
  - Esempio di misura; 48
- F**
- Features and Benefits; 5
  - Firmware Upgrade; 46
  - Flow/Return temperature; 24
  - Fuel technical data; 8
  - Fuels menu; 36
- G**
- Gas analysis; 21
  - Gas leak cheker; 30
  - Gas probe positioning; 16
  - Gas sampling probe; 8; 11
  - Gas sensors; 12
  - GENERAL; 8
  - GENERAL DESCRIPTION; 5
- H**
- Header setting; 41
  - HELP key; 41
  - How operate using ConfGas; 38
- I**
- Input of the smoke index; 24
- K**
- Keyboard; 18
  - Keypad; 8
- L**
- Leak test time; 45
  - Leakage checking mode; 9
  - Leakage limits table; 28
  - Letter of conformity; 47
  - line filter; 12
- M**
- Maintenance; 46
  - MAINTENANCE; 43
  - Measurement principle; 11
  - Measuring cells; 8
  - Measuring instruments; 14
  - Measuring Units; 40
  - MEMORY MANAGEMENT; 32
- N**
- Natural gas probe; 9
  - Numeric input; 19
- O**
- OPERATIONS; 18
  - Other measurements; 14
- P**
- Paper and Ribbon change; 26
  - PHYSICAL DESCRIPTION; 10
  - Plants/Clients menu; 33
  - Power supply; 15
  - Pressure and Draught; 13
  - Pressure decay procedure; 27
  - Pressure sensor; 8
  - Pressure/Draught measurement; 22
  - PRINCIPLE OF OPERATION; 11
- R**
- Recall memory; 32
  - RECOMMENDATIONS; 15

Remote temperature probe; 9

## S

Select by a list; 20

Sensor Diagnostic; 41

Serial Port; 44

Service Data; 42

Set-up menu; 43

Smoke index measurement; 13

Smoke measurement; 9; 23

Specifications; 6

status bar; 19

Store data analysis; 32

## T

T+RH% probe; 9

Temperature & Humidity probe; 30

Temperature measurements; 13

Temperature probes; 8

Text input; 20

## W

Warranty terms; 47

Water trap; 12

## Z

ZOOM function; 19