



CD-R/RW Drive  
**CRW8824S**  
SERIES

OWNER'S MANUAL

BEDIENUNGSANLEITUNG

MODE D'EMPLOI

MANUAL DE INSTRUCCIONES

English

Deutsch

Français

Español



## FCC INFORMATION

### **COMPLIANCE INFORMATION STATEMENT**

(DECLARATION OF CONFORMITY PROCEDURE)

Responsible Party: Yamaha Corporation of America  
Address: 6600 Orangethorpe Ave.  
Buena Park, CA 90620  
Telephone: 714-522-9011  
Fax: 714-228-3913  
Type of Equipment: CD Recordable/Rewritable Drive  
Model Name: CRW8824S  
CRW8824S-NB

This device complies with Part 15 of the FCC Rules.

Operation is subject to the following conditions:

- 1) this device may not cause harmful interference, and
- 2) this device must accept any interference received including interference that may cause undesired operation.

See user manual instructions if interference to radio reception is suspected.

#### **FCC INFORMATION (U.S.A.)**

**1. IMPORTANT NOTICE: DO NOT MODIFY THIS UNIT!**

This product, when installed as indicated in the instructions contained in this manual, meets FCC requirements. Modifications not expressly approved by Yamaha may void your authority, granted by the FCC, to use the product.

- 2. IMPORTANT:** When connecting this product to accessories and/or another product use only high quality shielded cables. Cable/s supplied with this product MUST be used. Follow all installation instructions. Failure to follow instructions could void your FCC authorization to use this product in the USA.

- 3. NOTE:** This product has been tested and found to comply with the requirements listed in FCC Regulations, Part 15 for Class "B" digital devices. Compliance with these requirements provides a reasonable level of assurance that your use of this product in a residential environment will not result in harmful interference with other electronic devices. This equipment generates/uses radio frequencies and, if not installed and used according to the instructions found in the users manual, may cause interference harmful to the operation of other electronic devices. Compliance with FCC regulations does not guarantee that interference will not occur in all installations. If this product is found to be the source of interference, which can be determined by turning the product "OFF" and "ON", please try to eliminate the problem by using one of the following measures:

Relocate either this product or the device that is being affected by the interference.

Utilize power outlets that are on different branch (circuit breaker or fuse) circuits or install AC line filter/s.

In the case of radio or TV interference, relocate/reorient the antenna. If the antenna lead-in is 300 ohm ribbon lead, change the lead-in to coaxial type cable.

If these corrective measures do not produce satisfactory results, please contact the local retailer authorized to distribute this type of product. If you can not locate the appropriate retailer, please contact Yamaha Corporation of America, 6600 Orangethorpe Avenue, Buena Park, CA 90620 U.S.A.

# LASER INFORMATION

## Laser Diode Properties

**Material:** GaAlAs  
**Wavelength:** 780-787 nm  
**Emission Duration:** Continuous  
**Laser Output Power:** Less than 44.6  $\mu\text{W}^*$   
\* This output is value measured at a distance 200 mm from the objective lens surface on the optical pick-up block.  
ANSI Class : Class 1

## Eigenschaften der Laserdiode

**Material:** GaAlAs  
**Wellenlänge:** 780-787 nm  
**Strahldauer:** Kontinuierlich  
**Laser-Ausgangsleistung:** Weniger als 44,6  $\mu\text{W}^*$   
\* Diese Leistung wurde in einem Abstand von 200 mm ab der Linsenoberfläche des optischen Sensorblocks gemessen.  
ANSI-Klasse: Klasse 1

## Caractéristiques de la diode laser

**Matériau:** GaAlAs  
**Longueur d'onde:** 780-787 nm  
**Durée d'émission:** Continue  
**Puissance de sortie du laser:** Moins de 44,6  $\mu\text{W}^*$   
\* Cette valeur de sortie a été mesurée à une distance de 200 mm depuis la lentille sur le bloc capteur optique.  
Classe ANSI: Classe 1

## Propiedades del diodo láser

**Material:** GaAlAs  
**Longitud de onda:** 780-787 nm  
**Duración de la emisión:** Continua  
**Potencia de salida láser:** Menos de 44.6  $\mu\text{W}^*$   
\* Esta salida es el valor medido a una distancia de 200 mm de la superficie del objetivo del bloque captor óptico.  
Clase ANSI : Clase 1

## CAUTION

Use of controls or adjustments or performance of procedures other than those specified herein may result in hazardous radiation exposure.

## ACHTUNG

Halten Sie sich beim Bedienen und Einstellen der Bedienungselemente sowie bei der Bedienungsabfolge an die Anleitung, da sonst gefährliche Strahlen austreten können.

## ATTENTION

L'emploi de commandes, de réglages ou un choix de procédures différents des spécifications de cette brochure peut entraîner une exposition à d'éventuelles radiations pouvant être dangereuses.

## PRECAUCION

El usar los controles o ajustar o realizar procedimientos diferentes a los especificados aquí resultará en peligrosas exposiciones a la radiación.

VARO! AVATTAESSA JA SUOIALUKITUS OHITETTAESSA OLET ALTTINA NÄKYMÄTTÖMÄLLE LASERSÄTEILYLLE. ÄLÄ KATSO SÄTEESEEN.

VARNING! OSYNLIG LASERSTRÅLNING NÄR DENNA DEL ÄR ÖPPNAD OCH SPÄRREN ÄR URKOPPLAD. BETRakta EJ STRÅLEN. STRÅLEN ÄR FARLIG.

CLASS 1 LASER PRODUCT  
LASER KLASSE 1 PRODUKT  
LUOKAN 1 LASERLAITE  
KLASS 1 LASER APPARAT  
PRODUIT LASER DE CLASSE 1

CAUTION - VISIBLE AND / OR INVISIBLE LASER RADIATION WHEN OPEN. AVOID EXPOSURE TO BEAM.  
VARNING - SYNLIG OCH / ELLER OSYNLIG LASERSTRÅLNING NÄR DENNA DEL ÄR ÖPPNAD. STRÅLEN ÄR FARLIG.  
VARO! AUKTRESSA OLET ALTTINA NÄKYMÄTTÖMÄLLE JA / TAI NÄKYMÄTTÖMÄLLE LASERSÄTEILYLLE. ÄLÄ KATSO SÄTEESEEN.  
VARNING - SYNLIG OCH / ELLER OSYNLIG LASERSTRÅLNING NÄR DENNA DEL ÄR ÖPPNAD. BETRakta EJ STRÅLEN.  
VORSICHT! SICHTBARE UND / ODER UNSICHTBARE LASERSTRÄHLUNG WENN ABDECKUNG GEÖFFNET. NICHT DEM STRAHL AUSSETZEN.  
ATTENTION - RADIATION VISIBLE ET / OU INVISIBLE LORSQUE L'APPAREIL EST OUVERT. EVITEZ TOUTE EXPOSITION AU FASCEAU.

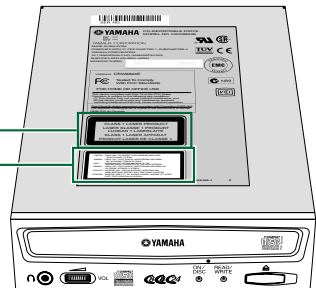

CD-R/RW Drive  
**CRW8824S**  
SERIES

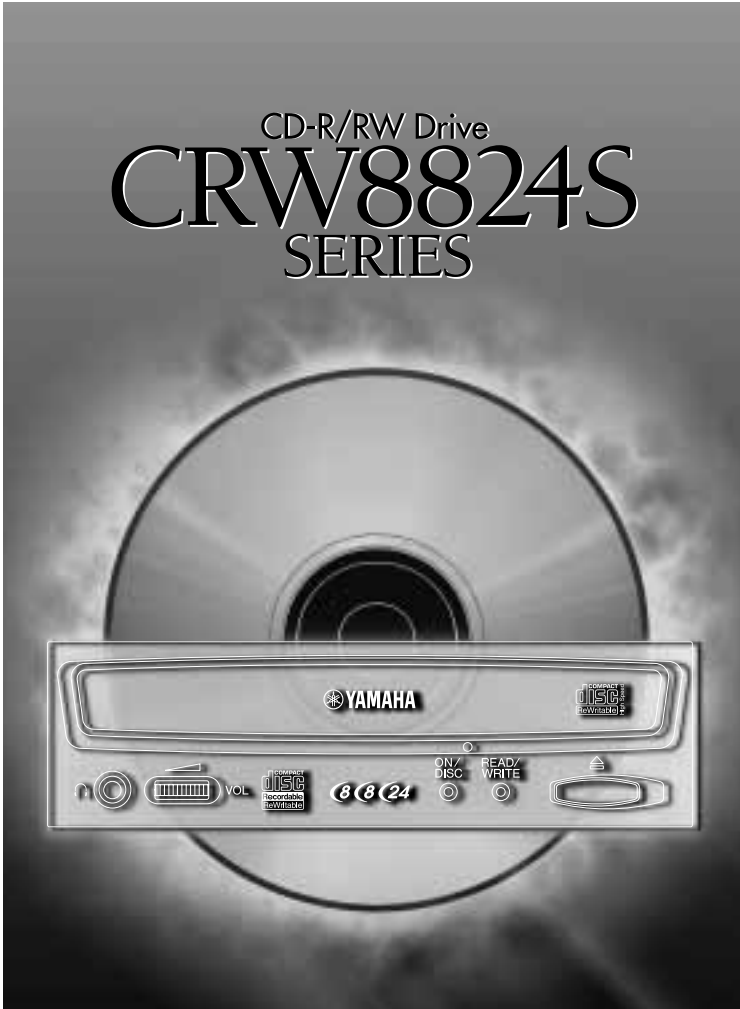

# OWNER'S MANUAL

# SAFETY PRECAUTIONS

## ***PLEASE READ CAREFULLY BEFORE PROCEEDING***

These precautions explain how to use the device correctly and safely, thereby preventing injury to yourself or to others. This section has been sub-divided into a WARNING section and a CAUTION section, according to the likelihood and nature of any potential injuries or damage inflicted. They relate to your personal safety, and also help you minimize the risk of damaging the device. Please read these sections carefully before proceeding.



## **WARNING**

**Always follow the basic precautions listed below to avoid the possibility of serious injury or even death from electrical shock, short-circuiting, damages, fire or other hazards. These precautions include, but are not limited to, the following:**

- Do not open the device or attempt to disassemble or modify it.  
Otherwise, there is an increased risk of electrical shock or fire. The device contains no user-serviceable parts. If it appears to be malfunctioning, have it inspected by qualified service personnel.
- Do not look inside the device.  
If you expose your eyes to the laser inside the device, you risk damage or loss of your vision.
- Do not insert fingers or foreign objects into the device.  
Otherwise, there is an increased risk of personal injury, electrical shock, damage to the device or fire. Please take particular care if small children are present.
- Do not expose the device to rain, use it near water or in damp or wet conditions or place containers on it that contain liquids which might spill into any openings.  
Otherwise, there is an increased risk of electrical shock, fire or personal injury.
- Follow the Owner's Manual carefully.  
Otherwise, there is an increased risk of personal injury, electrical shock, fire or damage to the unit. Follow the correct procedure when setting up the device.
- If unusual smells, sounds or smoke emanate from the device or if liquids enter the device, switch the computer off immediately and unplug it from the power outlet.  
Otherwise, there is an increased risk of electrical shock, fire or damage to the device. Return the device immediately to the store at which it was purchased or alternatively, to the nearest Yamaha Service Center (listed at the back of this manual).
- Make sure the computer is electrically grounded  
Otherwise, there is an increased risk of electrical shock.
- When opening up the computer, always unplug the computer from the electrical outlet. Do not touch the plug with wet hands.  
Otherwise, there is an increased risk of electrical shock.
- When used in a fan-cooled system, the drive should not be exposed to temperatures outside the range 5 ~ 40°C (41 ~ 104°F).



## CAUTION

---

**Always follow the basic precautions listed below to avoid the possibility of physical injury to yourself or others, or damage to the instrument or other property. These precautions include, but are not limited to, the following:**

- Always unplug the computer from the electrical outlet if it will not be used for a prolonged period of time or if there is a risk of lightning.  
Otherwise, there is an increased risk of electrical shock, short-circuiting or fire.
- Do not expose the device to excessive heat or vibrations or extreme cold or heat (such as in direct sunlight or near a heater).  
Otherwise, the front panel may become disfigured or the internal components may be damaged.
- Do not use the device near other electrical products such as televisions, radios or speakers.  
Otherwise, this may cause interference which can affect the proper operation of those other products.
- Do not place the device in an unstable position.  
Otherwise, it may accidentally fall down and be damaged or cause personal injury.
- Mount the device horizontally.  
Otherwise, written data may be destroyed. Set the device up according to the instructions in the Owner's Manual.
- Always remove the disc from the tray before transporting the device.  
Otherwise, written data may be destroyed.
- When cleaning the device, never use benzene, paint thinners, detergents or chemical-impregnated wiping cloths. Also, do not place vinyl, plastic or rubber objects on the device.  
Otherwise, the device may be damaged or its front panel may become discolored. Use a soft, dry cloth to wipe the device.
- Do not rest your weight on or place heavy objects on the device and do not use excessive force on the buttons, switches or connectors.  
Otherwise, there is an increased risk of damage to the device or personal injury.
- Do not listen to audio with headphones at high volume and for prolonged periods of time.  
Otherwise, there is an increased risk of hearing loss.
- Before using the device, set the volume dial to its lowest setting.  
Otherwise, sudden bursts of sound can cause hearing loss.
- Do not place the device near sources of magnetic interference, such as computer displays.  
Magnetic interference can affect the operation and stability of the device.
- Have the device serviced regularly.  
Otherwise, dust can build up inside the device, increasing the risk of fire or damage. For information about servicing charges, contact the store at which the device was purchased or alternatively, the nearest Yamaha Service Center (listed at the back of this manual). The device should be serviced about once a year.

## ■ About CD-R/RW discs

Please read the following regarding the handling of CD-R/RW discs.

1. Do not expose discs to excessive heat or vibrations or extreme cold or heat (such as in direct sunlight or near a heater).
2. Do not touch disc surfaces.  
When handling a disc, hold it by its edges.
3. Remove dust and dirt from disc surfaces.  
Use air-based dust removers. The surfaces may be scratched if wiped with a dry cloth.
4. Do not write or stick labels on disc surfaces except where indicated.
5. Do not clean discs with chemicals or detergents.
6. Do not bend or drop discs.

- 
- 1. The information contained in this manual is subject to change without prior notice.**
  - 2. All trademarks contained in this manual belong to their respective owners.**
  - 3. Yamaha does not bear any responsibility for any outcome as a result of using this device.**
  - 4. Reproduction of this manual, either in part or in full, is expressly forbidden.**
- 

## ■ Precautions for Transportation

Before transporting the device, always put it back in its original box . If the device is transported without adequate packing, the internal components may be damaged and cause the device to malfunction.

## ■ Distributing Discs

When writing important data or preparing data for distribution to others, make sure that the disc can be read properly before writing duplicates.

## ■ Copyrights

When writing to CD-R/RW, make sure that you are not infringing any copyrights. It is illegal to copy audio CDs for non-personal use. When backing up software, please make sure that you are not infringing any software copyrights for that product.

## ■ WARRANTY

YAMAHA AND SUPPLIERS ACCEPT NO LIABILITY FOR THE LOSS OF ANY DATA OR ANY PROBLEMS CAUSED AS A RESULT. AS A PRECAUTION, IT IS RECOMMENDED THAT THE DISCS BE TESTED AFTER THEY HAVE BEEN WRITTEN TO. FURTHERMORE, UNDER NO CIRCUMSTANCES DOES YAMAHA AND SUPPLIERS GUARANTEE THE RELIABILITY OF THE DISCS.



# Table of Contents

<b>Setup Flowchart .....</b>	<b>1</b>
<b>Introduction .....</b>	<b>2</b>
Features of the CRW8824E Drive .....	2
<b>System Configuration .....</b>	<b>3</b>
Computer .....	3
Software .....	3
Discs .....	4
Tools .....	5
<b>Front and Rear of Unit .....</b>	<b>6</b>
Front Panel .....	6
Rear Panel .....	7
<b>Installation .....</b>	<b>8</b>
First Steps .....	8
Installing the CRW8824E Drive .....	9
<b>Operation .....</b>	<b>24</b>
Loading a Disc .....	24
Ejecting the Disc .....	24
Ejecting a Disc in an Emergency .....	25
<b>Troubleshooting .....</b>	<b>26</b>
<b>Appendix .....</b>	<b>29</b>
Writing Modes .....	29
About the firmware .....	31
LED Indicator Messages .....	32
CRW8824E Specifications .....	33
Index .....	35

©2000 Yamaha Corporation. All Rights Reserved.

This document may not, in whole or in part, be copied, photocopied, reproduced, translated, transmitted or reduced to any electronic medium of machine readable form without prior consent in writing from Yamaha.

Windows is a registered trademark of Microsoft Corporation.

All other trademarks are the property of their respective companies.





# Setup Flowchart

This flowchart shows the procedure for setting up the CRW8824S drive. For easy cross-referencing, the relevant pages in this manual are also given.

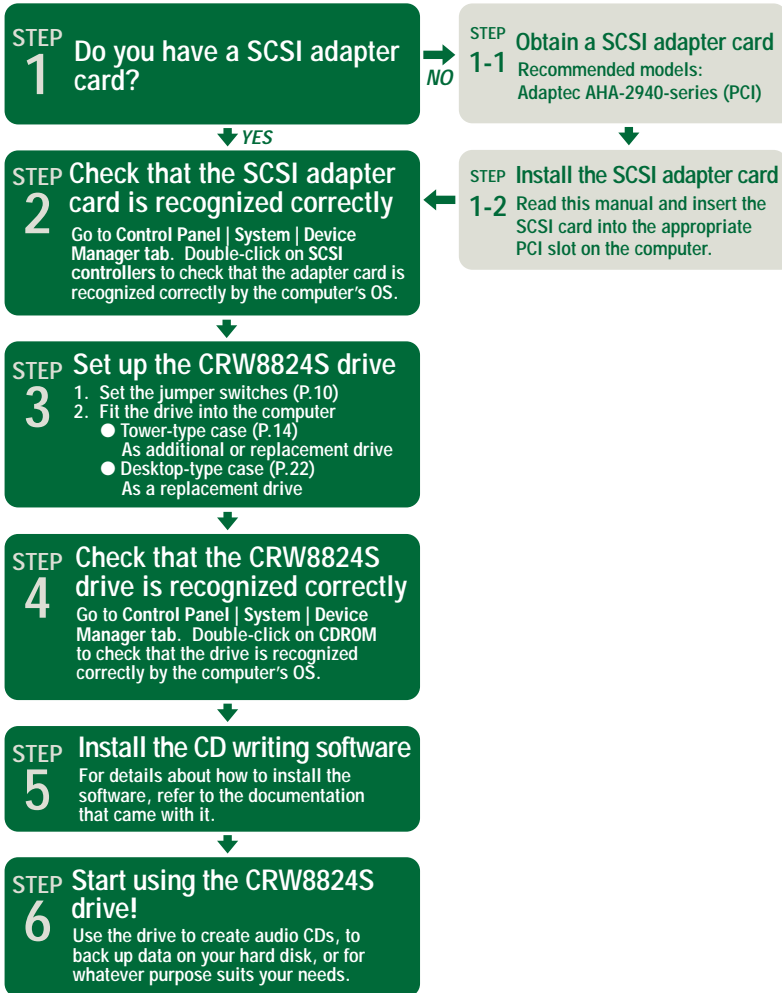



# Introduction

## Features of the CRW8824S Drive

### High speed

---

CD-R/RW discs can be written/rewritten at up to 8X speed. For example, an audio CD (74 minutes/650 MB) can be created in approximately 10 minutes. Data reading at up to 24X speed is supported.

### CD TEXT support

---

CD TEXT is a capability that adds text data to an audio CD. Information such as the song name or artist name can be recorded using writing software. The text data on the disc you create can be displayed by a CD player that is compatible with CD TEXT.

### Wide compatibility

---

Compatibility assurance data obtained through exchange of technical data with major disc manufacturers ensures compatibility with discs from a very wide range of manufacturers. 700 MB discs are also supported.

### High-fidelity audio

---

Writing software can be used to extract digital audio data at up to 24X speed. (This data can be saved in WAVE format in a Windows environment, or in AIFF format in a Macintosh environment.) Digital sound can be recorded with complete fidelity even when writing at 8X speed.

### Reliable writing

---

Yamaha's proprietary Pure-Phase Laser System\*<sup>1</sup> improves jitter values\*<sup>2</sup> to allow the signal to be recorded accurately. In addition, the 4 MB buffer memory and Running OPC\*<sup>3</sup> technology further enhance reliability.

**\*<sup>1</sup> Pure-Phase Laser System (patent applied for)**

Technology that reduces phase interference of the laser beam, so that it shines accurately on the disc.

**\*<sup>2</sup> Jitter value**

An important measure of recording quality. This has been improved 25% compared with Yamaha models not using this technology.

**\*<sup>3</sup> Running OPC**

CD-R/RW discs vary by manufacturer in their recording characteristics, and the laser output required to write data differs by disc. Running OPC is technology that solves this problem by automatically adjusting the output of the laser according to the material of the disc on which data is being written.



# System Configuration

In order to use the CRW8824S drive, your computer system will need to meet the following set of requirements.

## Computer

The minimum system requirements for using the CRW8824S drive are as follows:

- Any fully PC/AT-compatible computer.
- A Pentium-class or higher CPU running at 200MHz or faster.
- OS: Windows 95, Windows 98, Windows 98 SE (Second Edition), Windows NT4.0 with Service Pack 3 or later, or Windows 2000.
- RAM: 32MB memory, 64MB or more recommended.
- A vacant 5.25-inch drive bay for mounting the drive.
- A spare PCI expansion slot for a SCSI card (if one hasn't been installed yet).
- A SCSI card to connect SCSI devices (including the CRW8824S) to your computer. Make sure it has an internal bus connector. Yamaha recommends any of Adaptec's AHA-2940-series cards (PCI slot).

## Software

The software requirements for using the CRW8824S drive are as follows:

- CD writing software. This software must support the CRW8824S drive for writing to CD-R or CD-RW.





**NOTE** For details about how to install and use the software, refer to the documentation that came with it.

- When temporarily storing data on a hard disk prior to writing to CD-R/RW, you will need an extra area of 50 ~ 100MB free hard disk space. When creating an image file of the data on hard disk before writing to CD-R/RW, you will need as much hard disk space as the original data, plus an extra 50 ~ 100MB. However, this extra area is not needed when backing up directly from CD-ROM.

**NOTE** Data is written to disc much more reliably when writing from an image file, eliminating the likelihood of errors occurring. Furthermore, this solution is ideal when making multiple copies of discs since the original data is backed up to hard disk as an image file.

## Discs

The CRW8824S can record discs that carry the following logos.

	<p><b>CD-R discs</b></p> <ul style="list-style-type: none"> <li>• The CRW8824S can write these discs at 8X*, 6X*, 4X, and 1X speeds.</li> <li>• These discs can be played back in a CD-ROM drive or a CD player.</li> </ul> <p>* Compatible with “Orange Book Part 2.” * When writing at 8X or 6X speeds, please use “high-speed writing capable” discs.</p>
	<p><b>CD-RW discs</b></p> <ul style="list-style-type: none"> <li>• There are two types of CD-RW discs: those that support write/rewrite speeds of 4X, 2X and 1X, and those that support only 2X.</li> <li>• The CRW8824S can write/rewrite at 4X and 2X speeds on the first type of disc and at 2X on the second type of disc.</li> <li>• These discs can be read/played on a device (e.g., CD-ROM drive) that supports “CD-RW.”</li> </ul> <p>* Compatible with “Orange Book Part 3 Vol.1.”</p>
	<p><b>High Speed CD-RW discs</b></p> <ul style="list-style-type: none"> <li>• These discs allow writing/rewriting at 4X–10X speeds.</li> <li>• The CRW8824S can write/rewrite these discs at 8X and 4X speeds.</li> <li>• These discs can be read/played by a CD-RW drive that bears the High Speed CD-RW logo, or by a device (e.g., CD-ROM drive) that supports “CD-RW.”</li> </ul> <p>* Compatible with “Orange Book Part 3 Vol.2.”</p> <p> • <b>In order to write, erase, or read these discs using a CD-R/RW drive, a drive bearing the High Speed CD-RW logo must be used. When using a CD-ROM drive to read these discs, the drive must be capable of reading CD-RW discs.</b></p> <ul style="list-style-type: none"> <li>• <b>If these discs are used in a CD-R/RW drive not bearing the High Speed CD-RW logo, the discs may not be recognized, resulting in the computer not operating correctly or other malfunctions occurring.</b></li> <li>• <b>Refer to the page at the URL below before attempting to read these discs on a Yamaha CD-R/RW drive not bearing the High Speed CD-RW logo.</b></li> </ul> <p>URL: <a href="http://www.yamaha.co.jp/english/product/computer/">http://www.yamaha.co.jp/english/product/computer/</a></p>

**NOTE** The Orange Book standard defines how all recordable discs (including CD-R and CD-RW) are written. Part 2 of the Orange Book standard relates to CD-R discs and Part 3, to CD-RW discs. The standard was named after the color of the book’s pages.

## System Configuration

---

### About CD-ROM

A CD-ROM disc is a compact disc containing high-density read-only data. It has many applications, including the playback of music and video, the archiving of data, as well as on-line documentation. The following are descriptions of each CD-ROM format:

- CD-DA:** Up to 74 minutes of stereo audio is written in 16-bit resolution at a sampling rate of 44.1kHz (for a 74 minutes disc).
- Data CD:** Up to 650 megabytes of computer data is stored in standard ISO9660 format.
- Video CD:** These hold movies in which the video and audio data has been compressed using MPEG-1 technology.

## Tools

You will need the following tools at hand when installing the CRW8824S drive.

### Phillips Screwdriver

---

You will need to use this when removing the cover of your computer and when mounting the drive. You may also need to temporarily remove the sound card to gain access to the CD audio connectors. In which case a small screw retaining the sound card's face plate has to be removed.

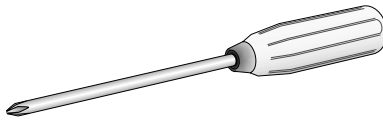

**NOTE** Make sure your screwdriver's head is the correct size for the screws you need to remove.

### Long-Nosed Pliers

---

You will need these to insert or remove the plastic shunts when setting the jumper switches at the back of the CRW8824S drive.

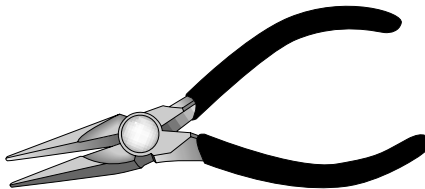



# Front and Rear of Unit

## Front Panel

The CRW8824S drive's front panel features the following:

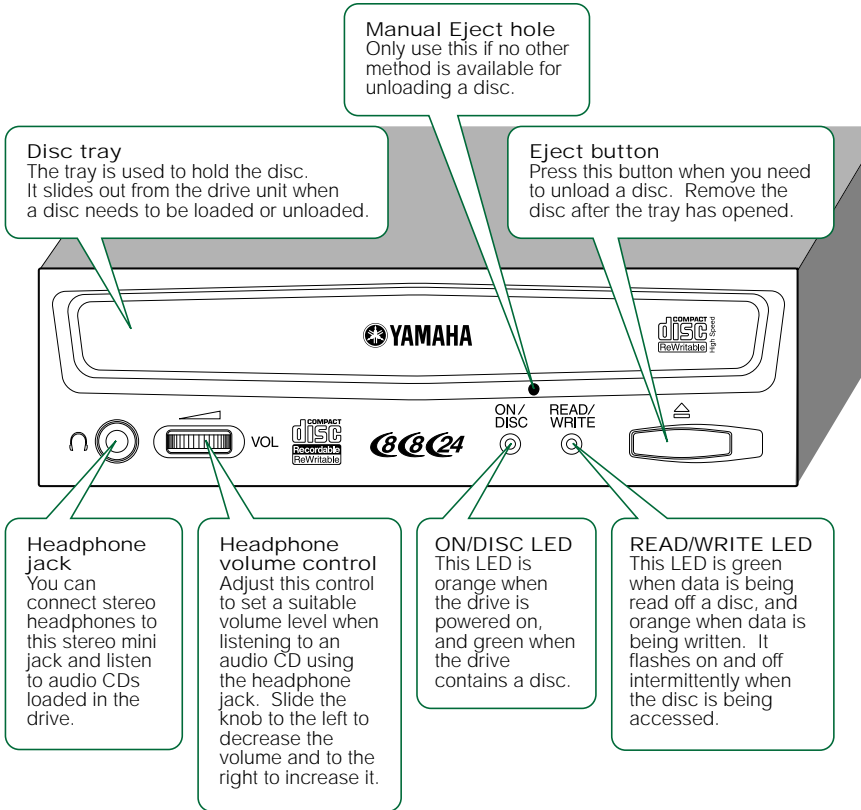

# Rear Panel

The CRW8824S drive's rear panel features the following:

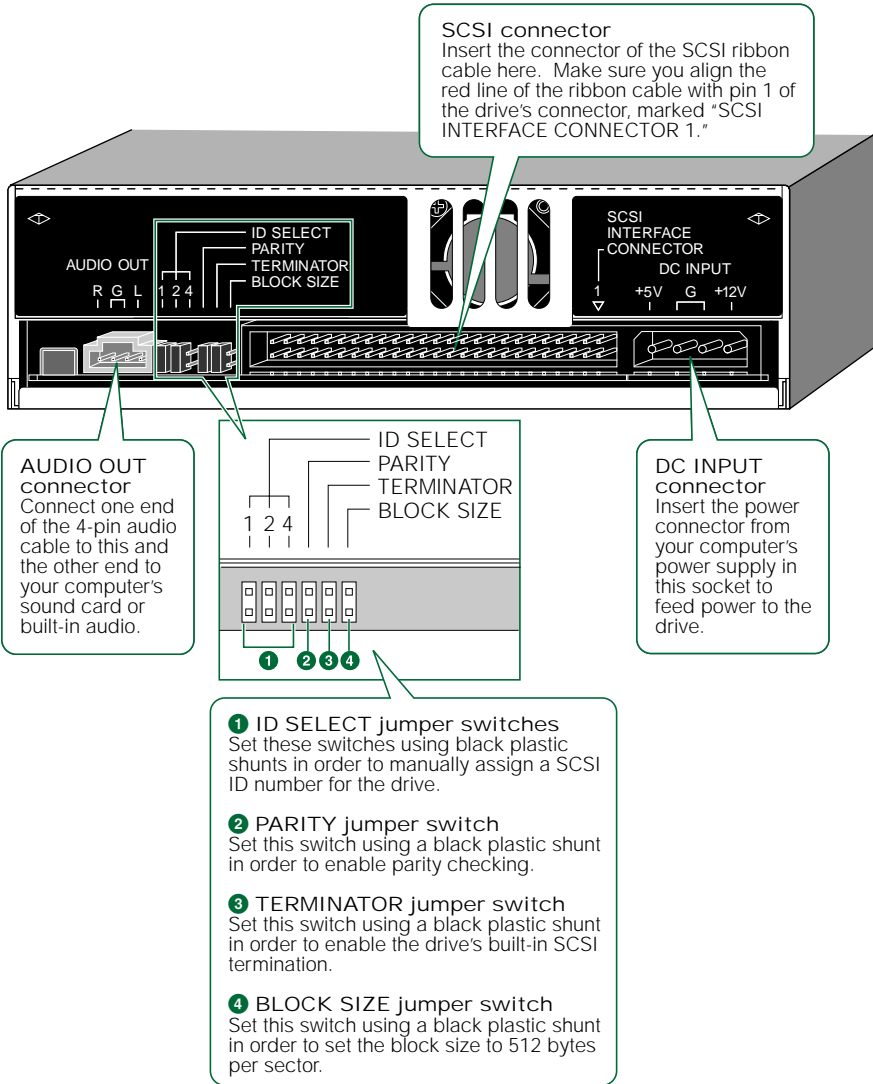

# Installation

This section gives a step-by-step guide to installing the CRW8824S drive. Make sure you have all the necessary tools.

## First Steps

Once you have taken the CRW8824S drive out of its packaging, you should immediately note down the serial number shown on the top of the drive together with a barcode. You may need to refer to this number when requesting User Support services. In the box below the following diagram, write down the 10-character serial number (consisting of 3 letters followed by 7 digits).

Drive's serial number  
(3 letters + 7 digits)

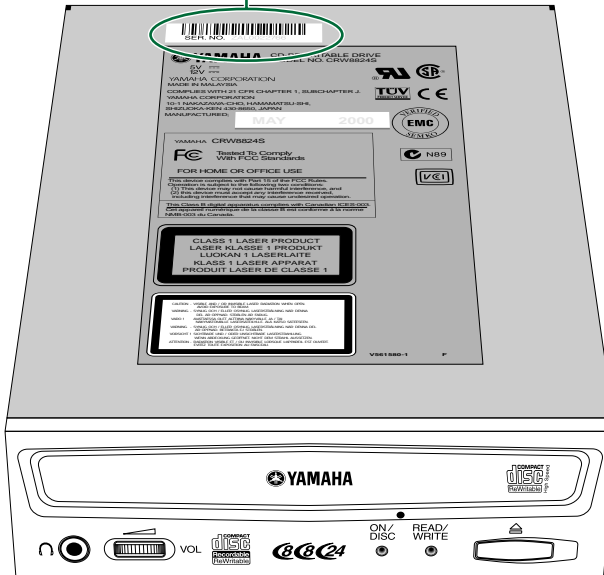

Serial No.										
------------	--	--	--	--	--	--	--	--	--	--

Before fitting the CRW8824S drive into the computer, you need to set up the drive using the jumper switches located at the rear of the unit. You'll need to set the following:

- SCSI ID number
- Parity check
- Termination
- Block size



## Installation

To set each jumper switch, you have to bridge the two pins in the respective column of the grid with a plastic shunt. Shunts are already attached to the jumper switches in their default configurations.

Rear Panel

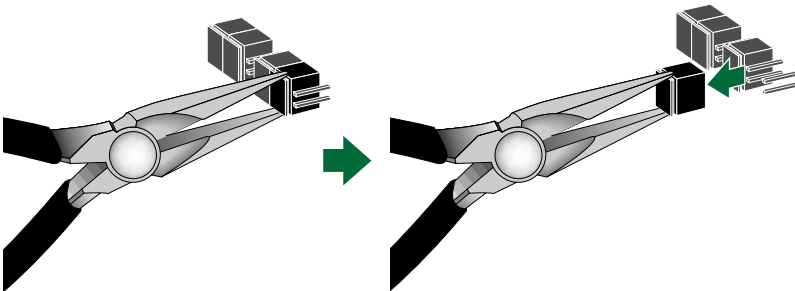
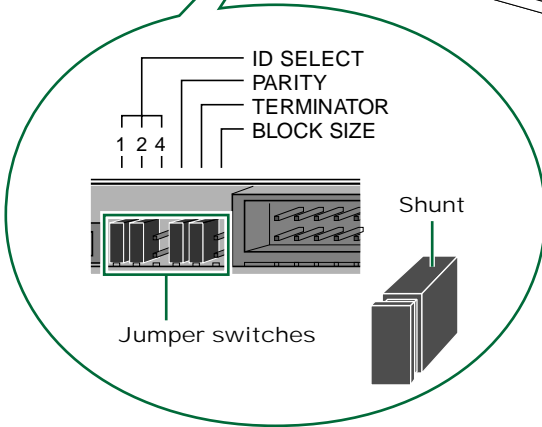
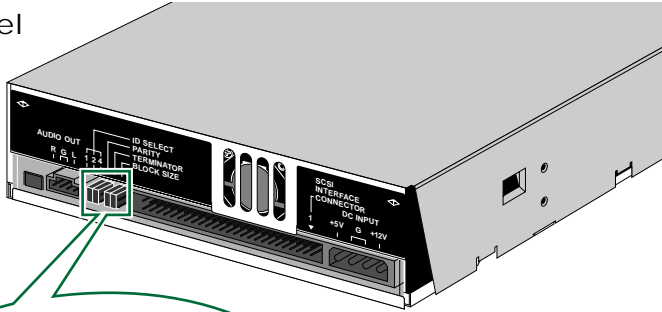

**NOTE** The plastic shunts actually contain metal for bridging the two pins of a jumper switch, creating an electrical connection between them when attached. When removed, the jumper switch is set to “OFF.” Store unused shunts in a safe place where they will not be lost.

**Use a pair of long-nosed pliers to attach or detach the shunts accordingly. However, make sure that the computer is switched off when doing so.**

## 1 SCSI ID number

Each of the SCSI devices connected to the computer is identified by its SCSI ID number. You need to assign a number from “0” to “7” for each SCSI device. Commonly, ID number “7” is reserved for the computer’s SCSI adapter card itself. Therefore, the CRW8824S can actually be assigned an ID number from “0” to “6.” The ID number is set by attaching/detaching the shunts on the ID Select jumper switches according to the diagram shown below.

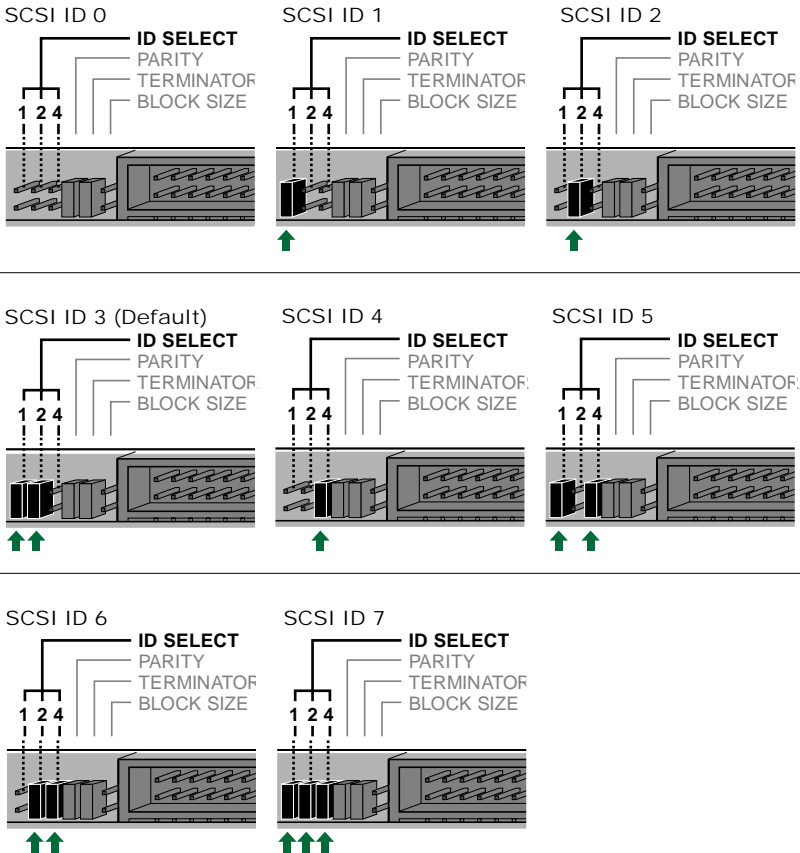

**NOTE** The SCSI ID number for each device on the chain must be unique. Make sure the CRW8824S drive’s SCSI ID number is not the same as that of any other device on the chain. By factory default, the CRW8824S is assigned ID number “3” but this can be changed.

**NOTE** If the SCSI card supports SCAM and SCAM is turned “ON,” a different ID number may be assigned if the SCSI ID number on the rear panel coincides with another SCSI device.

## 2 Parity Check

The parity check is used for error correction during data transmissions. If parity-checking has to be disabled, the shunt on the Parity jumper switch should be removed.

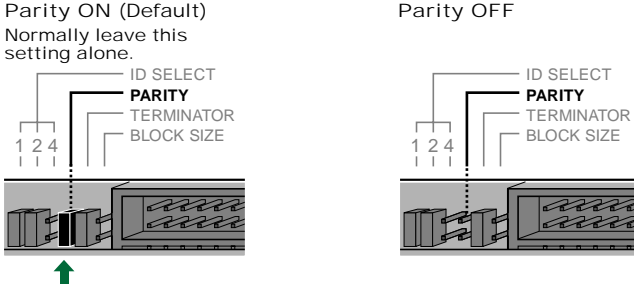

**NOTE** By factory default, the Parity switch is set to “ON” and should normally be left in this state.

## 3 Termination

Terminators prevent SCSI signals from being reflected off the last device in the chain. The SCSI terminator switch should be set to “ON” if the CRW8824S is the last device on the internal SCSI chain. If the CRW8824S is not the last device on the internal SCSI chain, the shunt on the Terminator jumper switch should be removed.

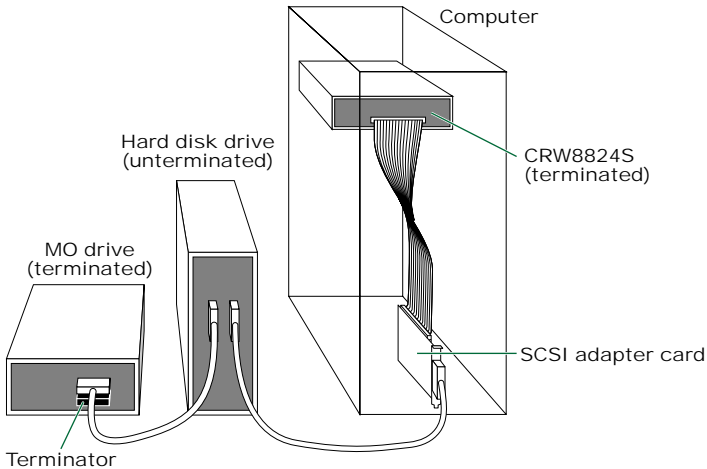

**NOTE** By factory default, the Terminator switch is set to “ON.”

Termination ON (Default)

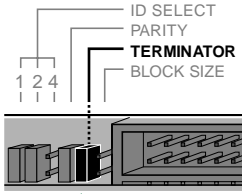

Set to "ON" if CRW8824S drive is last device on SCSI chain

Termination OFF

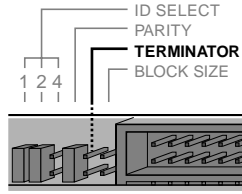

## 4 Block Size

The data block size of the CRW8824S can be set to 512 bytes per sector by setting the Block Size jumper switch to "ON." This is necessary when installing the CRW8824S on a UNIX-based workstation. It is not necessary for Windows 95/98/98SE/NT4.0/2000 computers.

Block size OFF (Default)

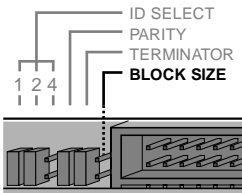

Block size ON

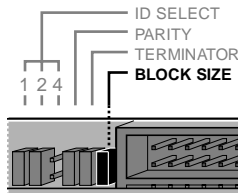

Set to "ON" when installing CRW8824S drive on UNIX workstation

**NOTE** By factory default, the Block Size jumper switch is set to "OFF" and should normally be left in this state.

# Installing the CRW8824S Drive

You can install the CRW8824S drive in one of two possible ways:

- **As an additional drive**

If the casing of your computer has a spare 5.25-inch drive bay available, such as with many tower-type designs, you can fit the CRW8824S drive in addition to the computer's existing CD-ROM drive.

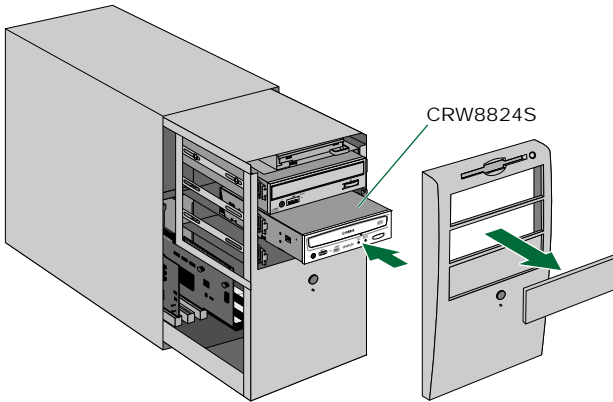

- **As a replacement drive**

If the casing of your computer does not have a spare 5.25-inch drive bay available, such as with many desktop-type designs, you can replace the computer's existing CD-ROM drive with the CRW8824S drive.

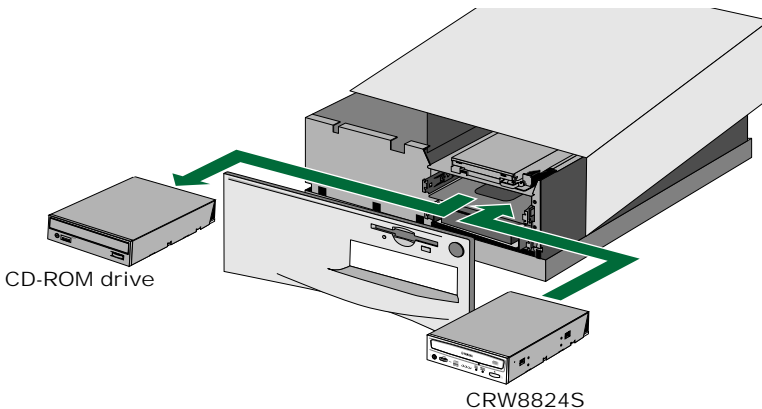

**NOTE** When replacing an IDE-type CD-ROM drive with the CRW8824S drive, you will also need a SCSI adapter card and an internal SCSI flat cable.

## Fitting the CRW8824S as an Additional Drive

- 1 Power down your computer and unplug it from the AC outlet.

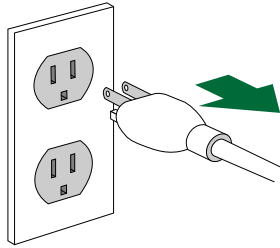

If you proceed without doing this, you run the risk of receiving an electric shock and/or short-circuiting and damaging components including the CRW8824S drive.

- 2 Remove the outer casing of the computer. If you need to remove screws in the process, make sure you don't lose them.

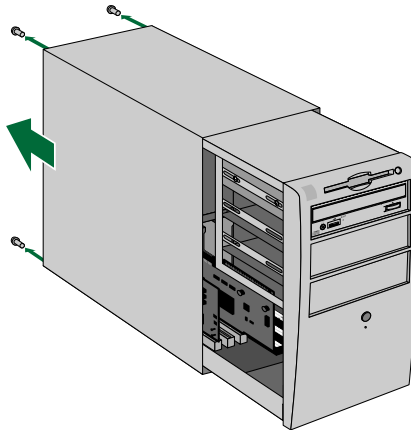

**NOTE** The method for removing the casing and fitting the drive in the drive bay can vary depending on the manufacturer. Refer to the documentation that came with your computer for further details.

## Installation

- 3 Touch a metal part of the computer's chassis or power supply unit to drain any static charge that may have built up inside your body.

Drain any static charge

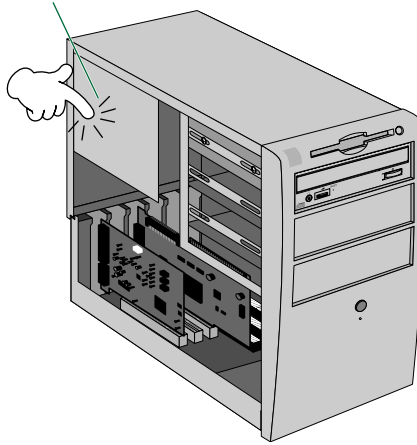

You can permanently damage equipment if you touch it while there is any static charge in your body.

- 4 Remove the front cover of a vacant 5.25-inch drive bay slot in the computer and slide the drive backwards into the slot.

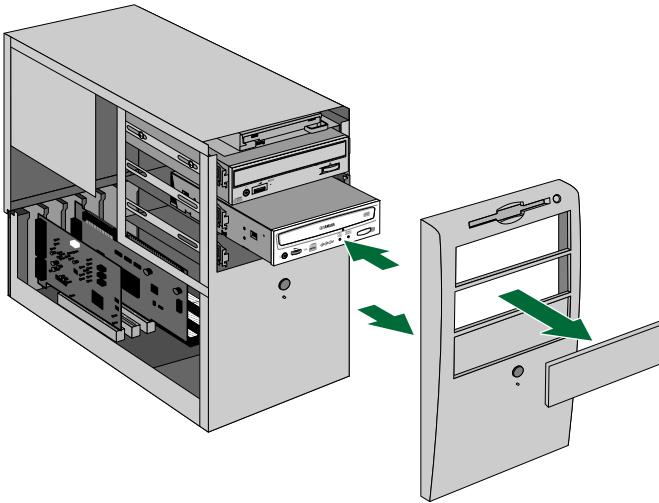

**NOTE** Do not apply excessive force when sliding the drive back into the drive bay slot.

- ⑤ Leave enough room behind the drive for connecting the power, SCSI and audio cables. Then tighten the four fastening screws on the sides of the unit by hand to hold the drive in place.

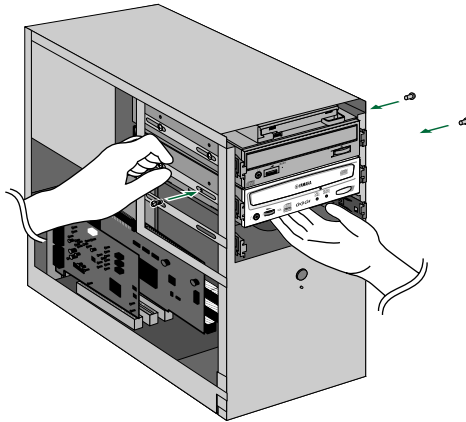

#### **About SCSI adapter card termination**

To connect internally-mounted SCSI devices, the SCSI adapter card's on-board internal SCSI termination must be switched ON. With most cards, this is done automatically. If your SCSI adapter card requires that you manually disable internal termination, refer to the documentation that came with it.



## Installation

- 6** Connect one end of the 50-pin SCSI flat cable to the computer's SCSI adapter card. Align the red line of the cable with Pin 1 of the card's SCSI connector. Next, connect a free 50-pin connector on the SCSI flat cable to the back of the CRW8824S drive such that the red line on the cable is aligned with pin 1, marked "SCSI INTERFACE CONNECTOR 1."

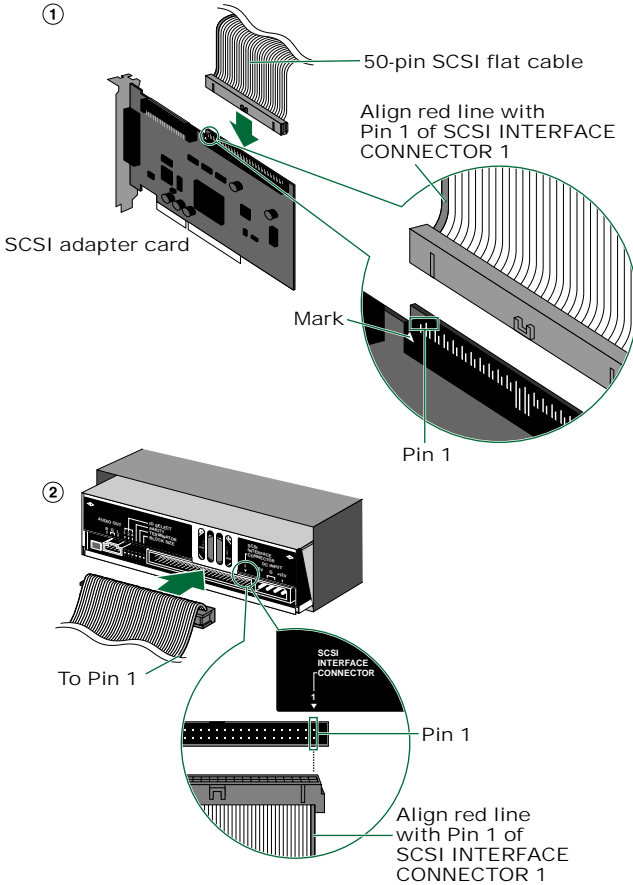

- 7** Connect the audio cable between the CRW8824S drive and the computer's sound card, or the motherboard's audio connector if it has built-in audio. One end of the audio cable has two connectors: a vertically-mounted type (PH) and a horizontally-mounted type (MPC). Choose one that matches your sound card's connector. The connector at other end of the cable is connected to "AUDIO OUT" of the CRW8824S drive. Make sure connector's lug is at the top.

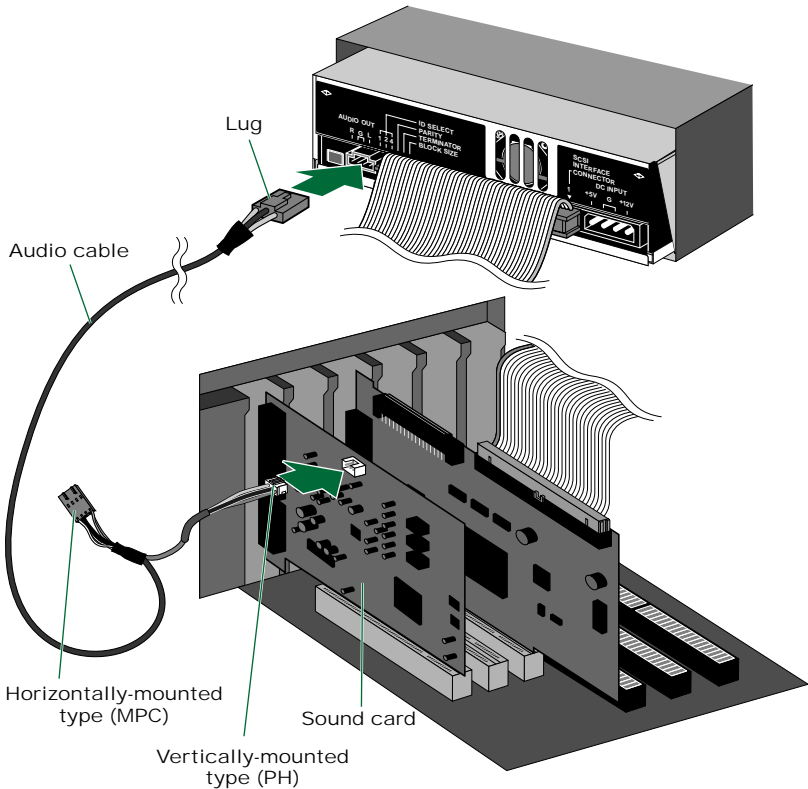

**NOTE** You do not need to connect the audio cable to write audio CDs since the audio is passed over the SCSI bus. It is required for playing back audio CDs on the CRW8824S drive via the computer's sound card. However, if a CD-ROM drive is already connected to the sound card, you should use this drive to play back your audio CDs. To listen to audio CDs without a computer sound card, connect headphones or speakers to the headphone jack on the CRW8824S drive's front panel.

## Installation

- 8 Connect a 4-pin power cable to the power supply connector of the CRW8824S marked “DC INPUT.”

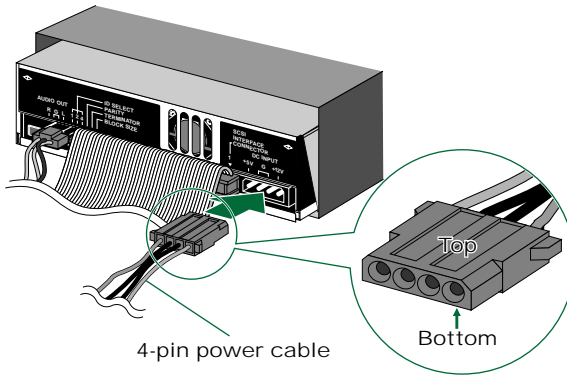

- NOTE** There may be more than one 4-pin power cable available. Any may be used.
- NOTE** These connectors are D-shaped so it is only possible to connect the power cables the correct way round. Do not apply excessive force when making this connection.

- 9 Tighten the four fastening screws on the side of the unit securely using a screwdriver.

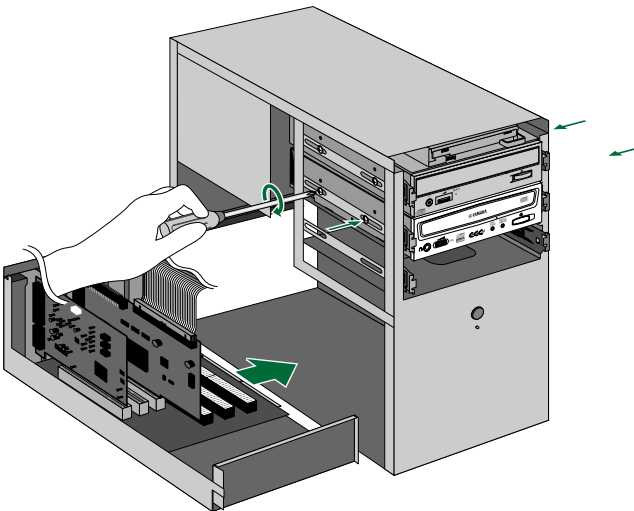

⑩ Attach the outer casing of the computer and any screws that were removed.

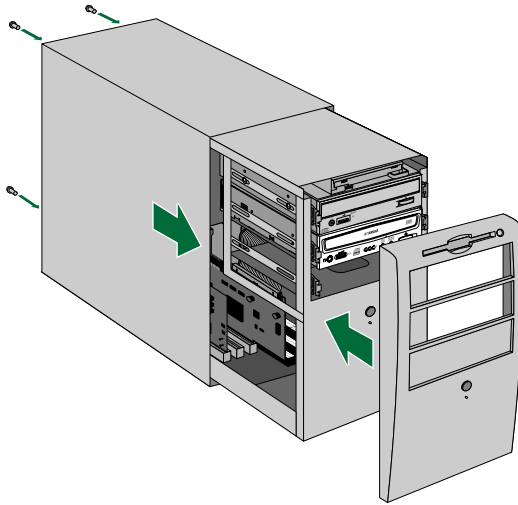

⑪ Reconnect the computer to the AC outlet and power it up.

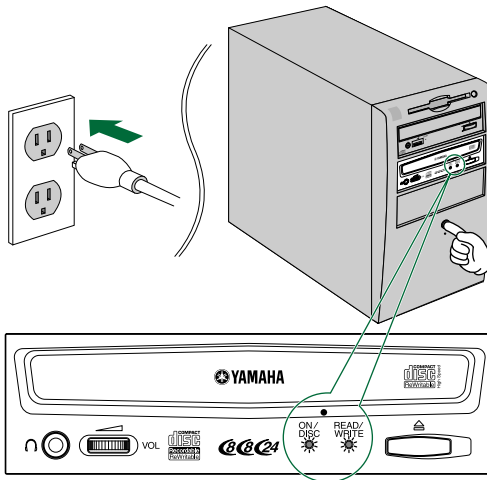

**NOTE** When you power up the computer, make sure both LEDs on the panel of the CRW8824S light up together for brief moment.

## Installation

**12** After the computer's operating system (Windows 95/98/98SE) has loaded, open the Control Panel and double-click on the System icon. Select the Device Manager tab and double-click on "CDROM." If the drive has been correctly installed, it should be listed as shown below. Similarly, double-click on "SCSI controllers" and the SCSI adapter card should be listed as shown below if it has been properly installed.

**NOTE** For more information about how to use the operating system, refer to the documentation that came with it.

**NOTE** If there is a **X** or **!** mark etc. next to the icon for the CRW8824S drive or the SCSI adapter card, this means that it has not been installed correctly.

**NOTE** When using Windows NT, you can verify by opening the Control Panel, double-clicking on SCSI Adapter and clicking the Devices tab.

**NOTE** For Windows 2000, double-click System in the Control Panel, select the Hardware tab, and click the Device Manager button in System Properties.

**13** Double-click "YAMAHA CRW8824S" listed under "CDROM" (in Windows 95/98/98SE) and click the Settings tab. Check the "Sync data transfer" checkbox. With "Sync data transfer" enabled, the data transfer between your CRW8824S drive and your computer is synchronized, meaning that the maximum possible data transfer rate can be achieved.

**NOTE** Refer to the documentation that came with your SCSI card for further details.

**NOTE** When using Windows NT, "Sync data transfer" will automatically be selected if the SCSI adapter card supports this feature. You will not need to change this setting.

**14** Install the CD writing software.

**NOTE** Refer to the documentation that came with the CD writing software for further details.

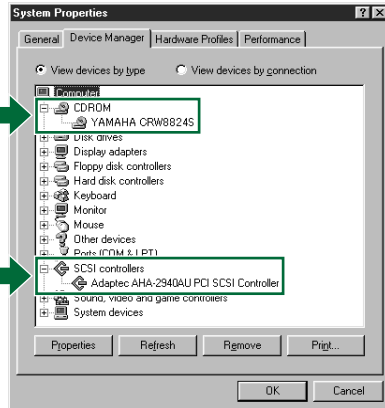

\* This is a screen shown in the Windows 98 environment.

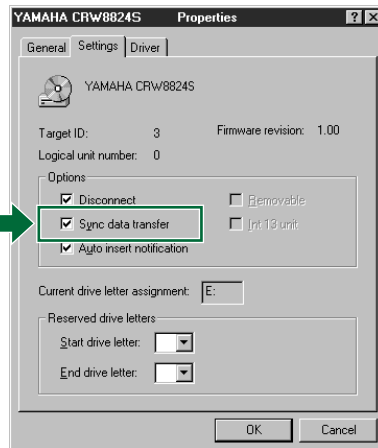

\* This is a screen shown in the Windows 98 environment.

## Replacing an Existing CD-ROM Drive with the CRW8824S

**NOTE** The existing CD-ROM drive in the computer is assumed to be an IDE-type.

- 1** Power down your computer and unplug it from the AC outlet.

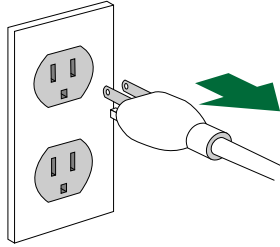

If you proceed without doing this, you run the risk of receiving an electric shock and/or short-circuiting and damaging components including the CRW8824S drive.

- 2** Remove the outer casing of the computer. If you need to remove screws in the process, make sure you don't lose them.

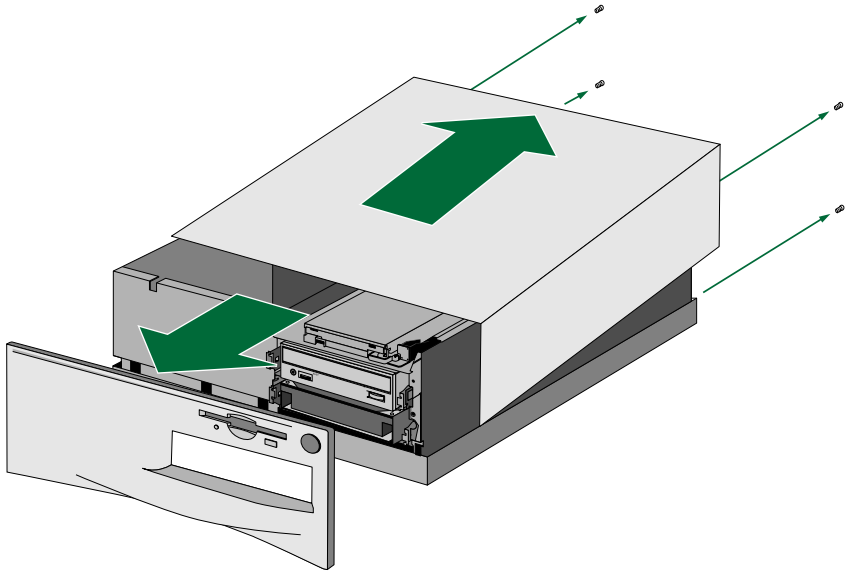

**NOTE** The method for removing the casing and fitting the drive in the drive bay can vary depending on the manufacturer. Refer to the documentation that came with your computer for further details.

## Installation

- 3 Touch a metal part of the computer's chassis or power supply unit to drain any static charge that may have built up inside your body.

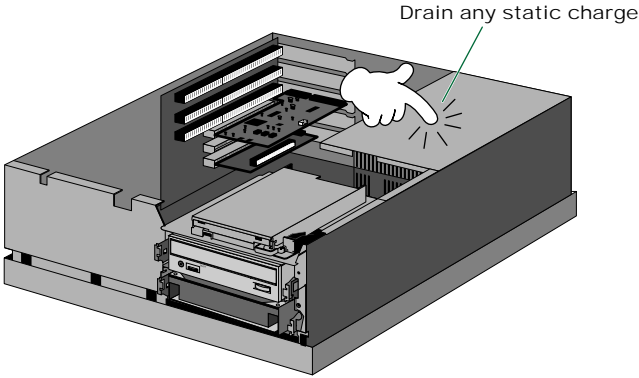

You can permanently damage equipment if you touch it while there is any static charge in your body.

- 4 Disconnect all the cables connected to the rear of the existing CD-ROM drive, and also disconnect the audio cable from the sound card or motherboard's audio connector.

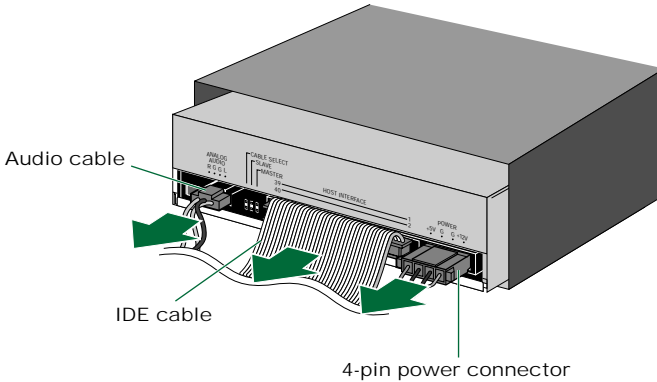

- 5** Remove the four screws holding the CD-ROM drive in place, then slide the drive forward and out from the drive bay.

Slide the CRW8824S drive backwards into the now-vacant bay without applying excessive force.

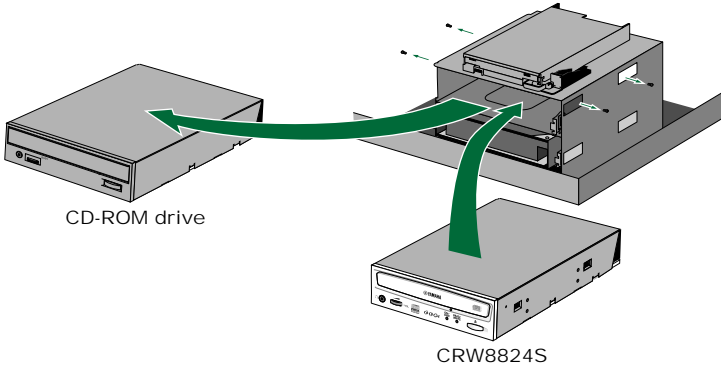

- 6** Leave enough room behind the drive for connecting the power, SCSI and audio cables. Then tighten the four fastening screws on the sides of the unit by hand to hold the drive in place.

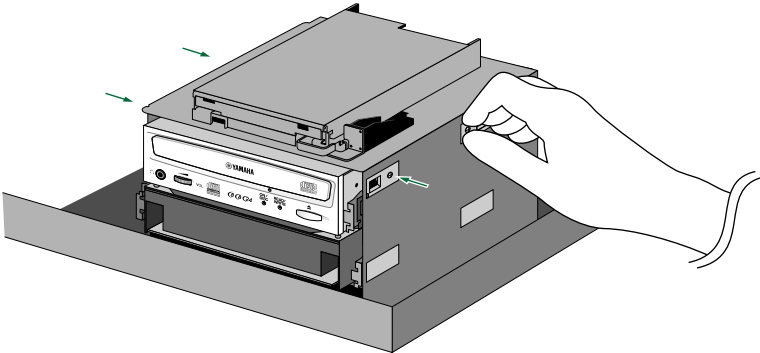



**About SCSI adapter card termination**

To connect internally-mounted SCSI devices, the SCSI adapter card's on-board internal SCSI termination must be switched ON. With most cards, this is done automatically. If your SCSI adapter card requires that you manually disable internal termination, refer to the documentation that came with it.

- 7** Connect one end of the 50-pin SCSI flat cable to the computer's SCSI adapter card. Align the red line of the cable with Pin 1 of the card's SCSI connector. Next, connect a free 50-pin connector on the SCSI flat cable to the back of the CRW8824S drive such that the red line on the cable is aligned with pin 1, marked "SCSI INTERFACE CONNECTOR 1."

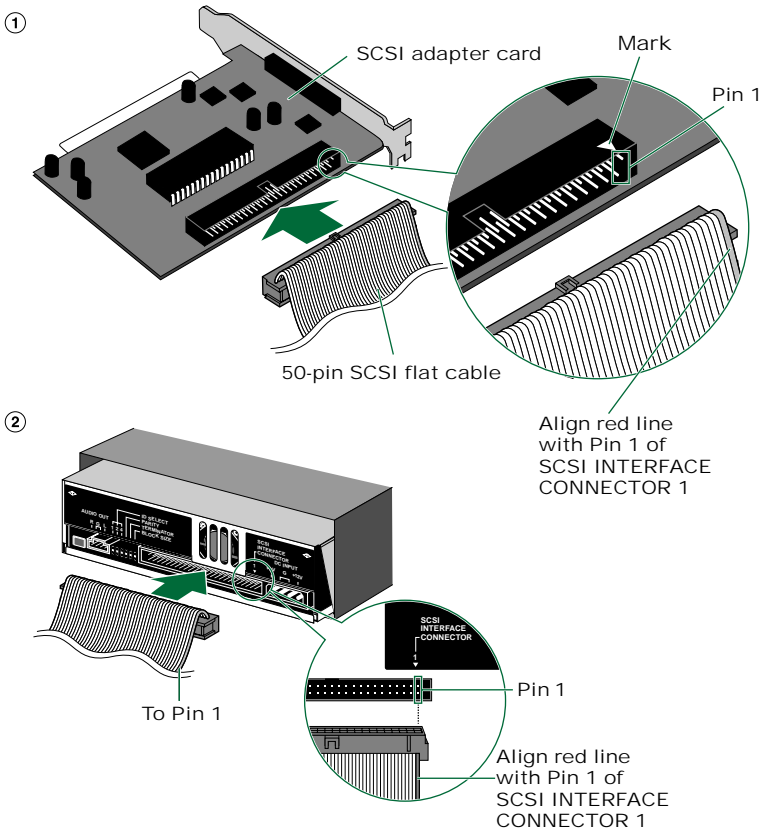

- 8** Connect the audio cable between the CRW8824S drive and the computer's sound card, or the motherboard's audio connector if it has built-in audio. One end of the audio cable has two connectors: a vertically-mounted type (PH) and a horizontally-mounted type (MPC). Choose one that matches your sound card's connector. The connector at other end of the cable is connected to "AUDIO OUT" of the CRW8824S drive. Make sure connector's lug is at the top.

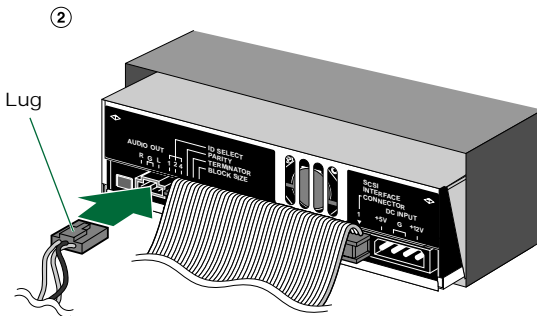
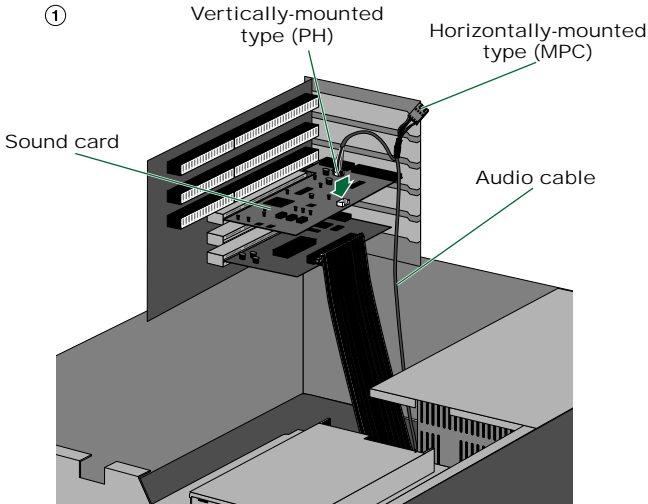

**NOTE** You do not need to connect the audio cable to write audio CDs since the audio is passed over the SCSI bus. It is required for playing back audio CDs on the CRW8824S drive via the computer's sound card. However, if a CD-ROM drive is already connected to the sound card, you should use this drive to play back your audio CDs. To listen to audio CDs without a computer sound card, connect headphones or speakers to the headphone jack on the CRW8824S drive's front panel.

## Installation

- 9 Connect the 4-pin power cable to the power supply connector of the CRW8824S marked “DC Input.”

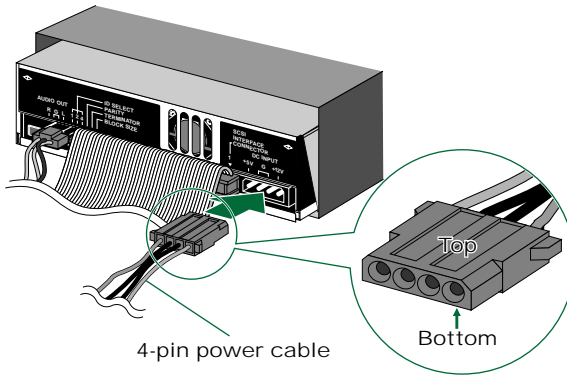

- NOTE** There may be more than one 4-pin power cable available. Any may be used.
- NOTE** These connectors are D-shaped so it is only possible to connect the power cables the correct way round. Do not apply excessive force when making this connection.

- 10 Tighten the four fastening screws on the side of the unit securely using a screwdriver.

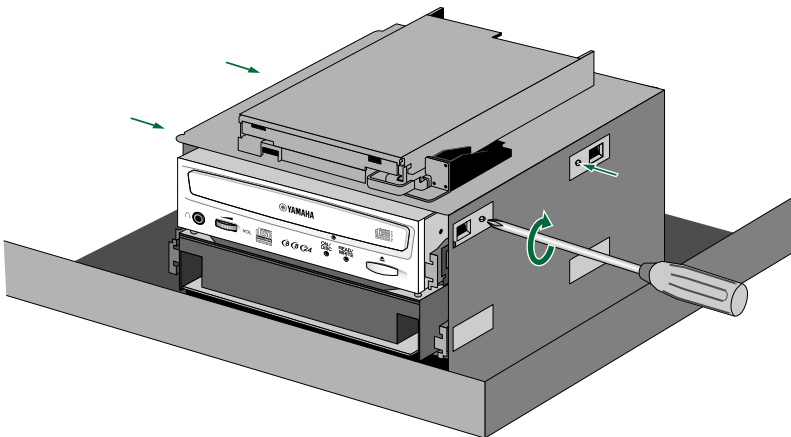

11 Attach the outer casing of the computer and any screws that were removed.

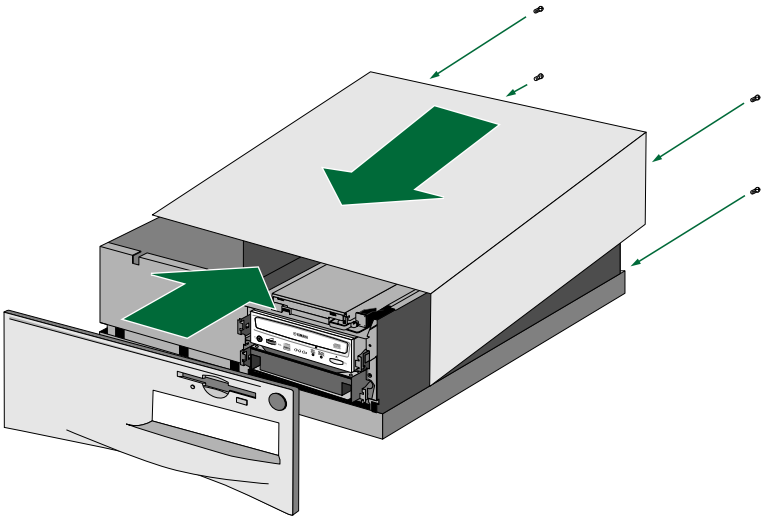

12 Reconnect the computer to the AC outlet and power it up.

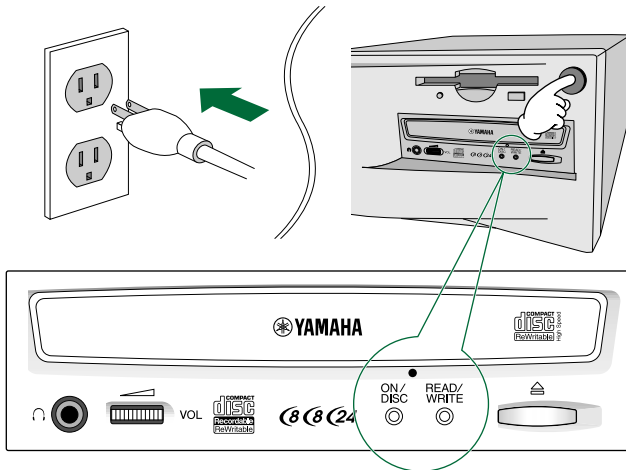

**NOTE** When you power up the computer, make sure both LEDs on the panel of the CRW8824S light up together for brief moment.

## Installation

- 13** After the computer's operating system (Windows 95/98/98SE) has loaded, open the Control Panel and double-click on the System icon. Select the Device Manager tab and double-click on "CDROM." If the drive has been correctly installed, it should be listed as shown below. Similarly, double-click on "SCSI controllers" and the SCSI adapter card should be listed as shown below if it has been properly installed.

**NOTE** For more information about how to use the operating system, refer to the documentation that came with it.

**NOTE** If there is a **X** or **!** mark etc. next to the icon for the CRW8824S drive or the SCSI adapter card, this means that it has not been installed correctly.

**NOTE** When using Windows NT, you can verify by opening the Control Panel, double-clicking on SCSI Adapter and clicking the Devices tab.

**NOTE** For Windows 2000, double-click System in the Control Panel, select the Hardware tab, and click the Device Manager button in System Properties.

- 14** Double-click "YAMAHA CRW8824S" listed under "CDROM" (in Windows 95/98/98SE) and click the Settings tab. Check the "Sync data transfer" checkbox. With "Sync data transfer" enabled, the data transfer between your CRW8824S drive and your computer is synchronized, meaning that the maximum possible data transfer rate can be achieved.

**NOTE** Refer to the documentation that came with your SCSI card for further details.

**NOTE** When using Windows NT, "Sync data transfer" will automatically be selected if the SCSI adapter card supports this feature. You will not need to change this setting.

- 15** Install the CD writing software.

**NOTE** Refer to the documentation that came with the CD writing software for further details.

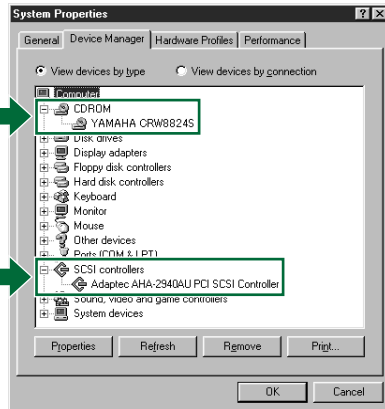

\* This is a screen shown in the Windows 98 environment.

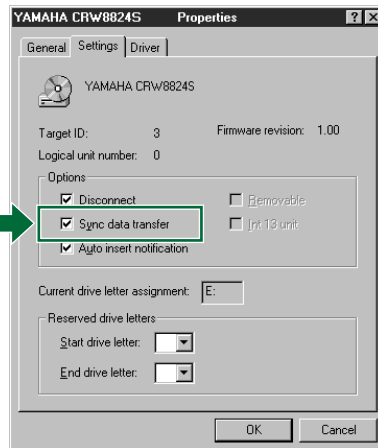

\* This is a screen shown in the Windows 98 environment.

# Operation

This section explains how to operate the CRW8824S drive after you have installed it. Make sure the computer is powered up.

## Loading a Disc

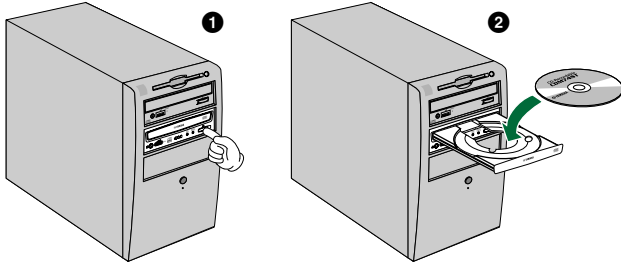

- 1 Press the Eject button on the CRW8824S drive's front panel.**
- 2 Place the disc onto the tray with its label or printing facing upward.**
- 3 Press the Eject button to close the tray.**

**NOTE** When a disc is loaded, the ON/DISC LED is lit up in orange first, then changes to green. For more details, refer to page 38.

**NOTE** Do not push or pull the tray using excessive force. Doing so can damage the drive or the disc. Instead, always use the Eject button to open or close the tray.

## Ejecting the Disc

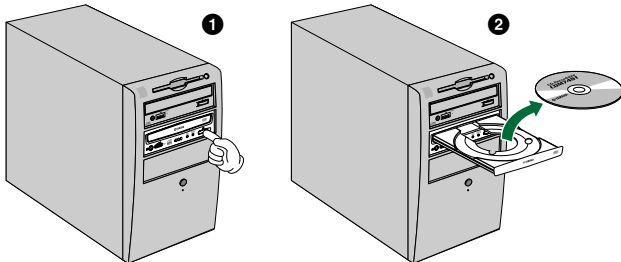

- 1 Press the Eject button on the CRW8824S drive's front panel.**
- 2 Remove the disc from the tray.**
- 3 Press the Eject button to close the tray.**

## Operation

- NOTE** It may not be possible to eject the disc tray while a disc is being read or in other situations, depending on the SCSI command.
- NOTE** Only remove the disc after the disc tray has opened fully. Otherwise, you risk damaging the drive or the disc.

## Manually Ejecting a Disc in an Emergency

If the disc tray fails to open for some reason, such as a power outage, it can be opened manually.

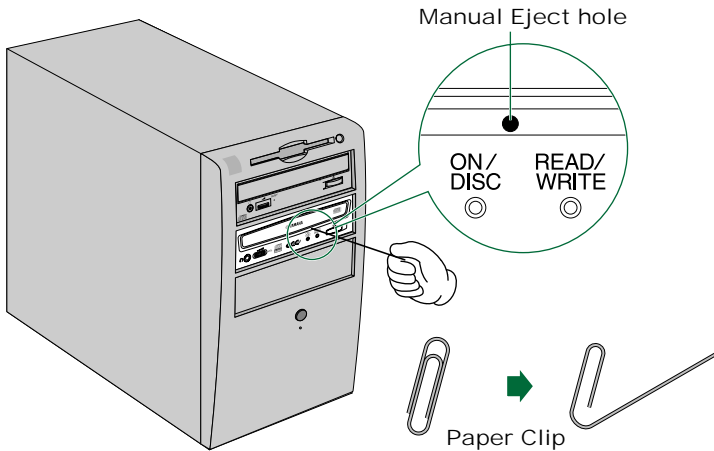

**You should only attempt to eject a disc manually as a last resort. Malfunctions may occur if you do this too frequently.**

- 1 Power down the computer.**
- 2 Find a pin-like tool with a diameter of 2mm or less to fit through the Manual Eject hole on the drive's front panel.**

**NOTE** A straightened paper clip is ideal for this purpose.

- 3 Push the tool gently into the Manual Eject hole until the spring-loaded mechanism ejects the tray and disc.**

# Troubleshooting

Please also refer to the YAMAHA CD-R/RW Drives web site for more information.

**YAMAHA CD-R/RW Drives web site URL:**

<http://www.yamaha.co.jp/english/product/computer/>

<http://www.yamaha-yste.com/> (Europe)

## **The drive does not power up.**

---

- Is the 4-pin power cable from the computer's power supply attached correctly?

## **The computer does not start up.**

---

- Is the SCSI card installed correctly? Please read the instructions that came with your SCSI card for details.

## **The CRW8824S drive is not recognized.**

---

- Is the 4-pin power cable from the computer's power supply attached correctly, and does the drive power up? Also, is the SCSI cable connected correctly? If the system has started up normally, you will be able to see the CRW8824S drive and SCSI card listed in **Control Panel | System | Device Manager tab**. The drive will be listed when you double-click on **CDROM** and the SCSI card will be listed when you double-click on **SCSI controllers**. (→P. 21, 29)  
When you power up your computer, you can access the machine's hardware SCSI BIOS settings before Windows is loaded. You can set your computer to recognize the SCSI card and CRW8824S drive in the BIOS.

**NOTE** Generally, the BIOS (Basic Input / Output System) is a small program that resides on a ROM chip on the computer's motherboard as well as on some expansion cards. It checks the system and its devices (such as serial ports and hard disk controllers) before loading the operating system (OS).

- Are you using the correct SCSI driver?  
If the SCSI card has not been installed correctly under Windows 95/98/98SE, make sure that you have installed the most recent drivers supplied by the SCSI card manufacturer.  
If the SCSI card has not been installed correctly under Windows NT/2000, update to the most recent ASPI drivers supplied by the manufacturer of the SCSI card or the CD-writing software.  
For information about the latest version of any driver, please contact the respective hardware/software manufacturers.
- Is the SCSI adapter card recognized correctly by the operating system (OS)?  
The drivers for your SCSI adapter card may be incorrect. For more details, contact the manufacturer of your SCSI adapter card.



## Troubleshooting

---

- Is the drive's SCSI ID number the same as that of another device on the SCSI chain? (→P. 10)
- Are the pins and holes on the SCSI connectors straight and not deformed? Check the connectors.
- Is the terminator on the CRW8824S drive set correctly?  
It should be set to **ON** only if it is the last device on the SCSI chain. Otherwise, it should be set to **OFF**. (→P. 11)
- Is the termination on the SCSI card set such that internal SCSI devices can be connected?  
Please read the instructions that came with your SCSI card for details.
- To write to CD-R/RW discs, your CD writing software must support the CRW8824S drive.  
To find out if it does, contact the manufacturer of your CD writing software.

### The disc tray does not come out.

---

- Is the CRW8824S drive powered up?
- Some CD writing applications will lock the disc tray once loaded.  
In which case, use the eject command from within the application. Alternatively, read the manual that came with the application.

### The disc keeps being ejected.

---

- Has the disc been placed on the disc tray correctly?

### The drive does not operate correctly.

---

- Is the disc compatible with the CRW8824S drive?

**NOTE** Even if the disc is of a type compatible with the CRW8824S drive, some varieties of discs can still be unreadable on it.

- Is there dust on the disc tray or on the disc itself?
- Is the terminator of the last device on the SCSI chain set to "ON?" Or if it has no built-in termination, has a terminator been attached?
- Does the computer have a sufficient power supply?  
The CRW8824S has a power consumption of 11W (when reading and writing).
- Does your computer have several different CD writing applications installed?  
If you use more than one CD writing application simultaneously, the behavior of the drive can become unpredictable.

---

**The drive ejects or fails to read the disc, or the ON/DISC LED remains lit in orange after the disc has been loaded (meaning that the disc has not been recognized). (→P. 38)**

---

- Disconnect the SCSI cable from the drive but leave the power cable connected, then load a disc.
- There may be problems with the disc itself. If the drive fails to recognize a variety of discs including audio CDs, CD-ROMs and blank CD-R/RW discs (the ON/DISC LED remains lit in orange after any discs have been inserted), you should contact your nearest Yamaha dealer.

---

**Errors occur when backing up at 6X or 8X speed from a separate CD-ROM drive to the CRW8824S drive.**

---

- A possible reason is that the CD-ROM drive is not suitable. Please use a high-speed CD-ROM drive. However, for various possible reasons, you may still encounter errors even if you are using a 32X or 42X speed CD-ROM drive. Therefore, before writing directly at 6X or faster speed, you should check that it is possible to do so by choosing to test before writing.

---

**The “Buffer Underrun” error message is displayed.**

---

- Try the following:
  - Lower the writing speed setting.
  - Create an image file of the CD on the computer’s hard disk.
  - Defragment the hard disk.
  - Turn hard disk power management off.
  - Deactivate the Active Desktop (if you are using Internet Explorer 4 or 5).
  - Disable network access.
  - Close other applications (including screen savers, task schedulers, etc.).

**NOTE** Errors can occur if you knock the CRW8824S drive while it is writing to disc.

**NOTE** When using packet writing on a CD-RW disc, the actual data capacity is 100MB less than that stated on the cover of the disc. The difference in capacity is dependent on the writing mode.



## Writing Modes

### Disc-at-Once (DAO)

This mode is used when writing a complete disc in a single pass without pausing. Data cannot be added later, even if the full capacity of the blank disc has not been used.

Example: General CD-ROM

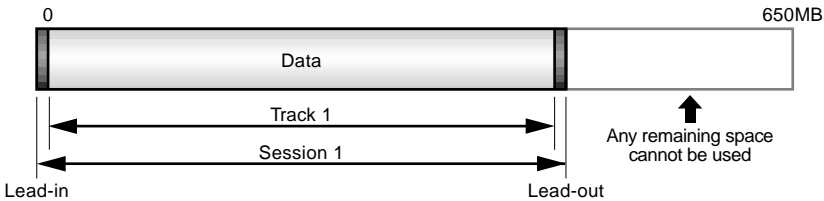

Example: Audio CD

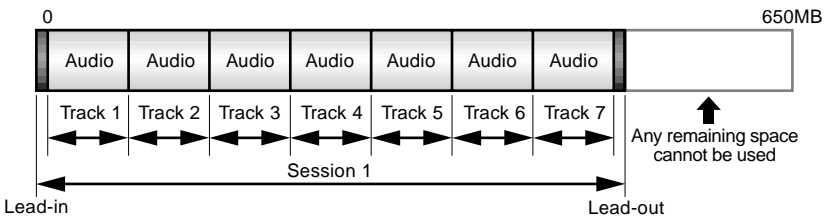

**NOTE** The lead-in and lead-out areas signify the beginning and end points of a session. They are not part of the data but contain information about the session itself. Basically, a session consists of a lead-in, data, and a lead-out.

### Track-at-Once (TAO)

This mode is used when writing data to a disc one track at a time. More tracks can be added later if there is enough space left on the disc. This is why Track-at-Once mode is sometimes referred to as Multisession.

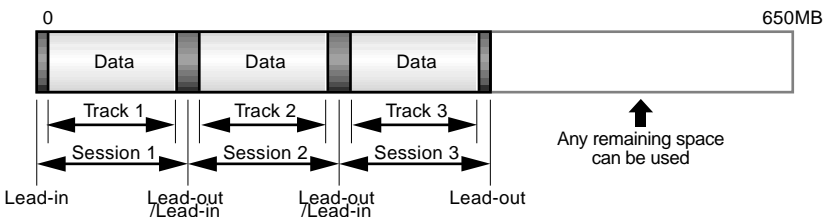

**NOTE** Only the first session of a multisession disc can be played back on a conventional audio CD player. Single session discs can be played back completely.

## Session-at-Once (SAO)

As a writing method that combines the advantages of the above-mentioned “Disc-at-Once” and “Track-at-Once,” you can combine multiple tracks into one session and write them, and then add additional data.

For example, this is the writing method used to create a CD EXTRA format CD. The music tracks will be recorded in the first session, and the data will be recorded in the second session.

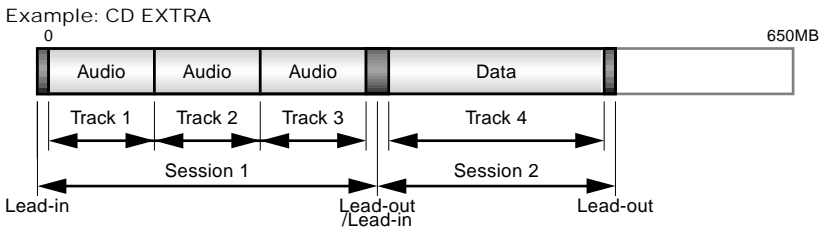

## Packet Writing

This mode is used when writing to a track of a disc using small blocks of data called “packets,” in a manner similar to a floppy disk. This mode is useful when making small incremental backups of data. You will need to use software which specifically supports packet writing, such as Adaptec’s DirectCD.

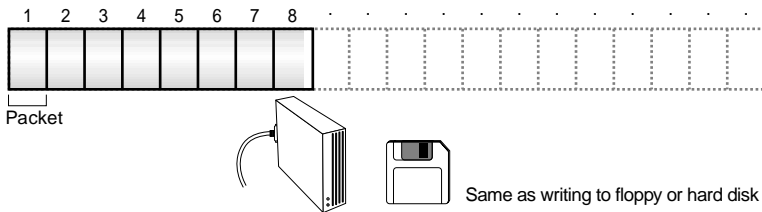

**NOTE** Discs must be formatted before they can be used for packet writing. With CD-RW, erased data can be overwritten until the disc is completely full.

With CD-R, the space used by the erased data cannot be reused and is “masked” so that it is no longer visible. This can be done up to 100 times.

## About the firmware

The “firmware” is a small piece of software built into the CRW8824S drive, and is used to control its basic operation. Since it resides in flash memory, it can be overwritten and updated.

To ensure the correct operation of the CRW8824S drive, updates to the firmware will be made available. You can find information about the most recent firmware for the drive on YAMAHA CD-R/RW Drive web site.

### URL for YAMAHA CD-R/RW Drive web site

<http://www.yamaha.co.jp/english/product/computer/>

<http://www.yamaha-yste.com/> (Europe)

The most recent user support information, including firmware updates, can be found in the CD-R area of Yamaha’s web site. Please check this information regularly.

**NOTE** The firmware is completely unrelated to the CD writing application software.

## Determining the firmware version of the CRW8824S drive (in Windows 95/98/98SE)

Go to Control Panel | System | Device Manager tab, double-click on CDROM, then double-click on YAMAHA CRW8824S.

SCSI ID number

When updating the CRW8824S drive's firmware, you will need to enter its SCSI ID number. You can check the number here.

The firmware version will increase as more improvements are incorporated.

\* This is a screen shown in the Windows 98 environment.

**NOTE** When using Windows NT, you can verify by opening the Control Panel, double-clicking on SCSI Adapter and clicking the Devices tab. Then right-click on “YAMAHA CRW8824S” and select Properties.

**NOTE** On Windows 2000, the firmware version will not be displayed. Use your writing software to check the firmware version.

# LED Indicator Messages



Status	ON/DISC LED	READ/WRITE LED
Power on (reset)	● → —	● → —
Ready (no disc)	☀ → ●	—
Loading disc	☀ → ☀	—
Ejecting disc	☀ → ●	—
Ready (disc loaded)	☀ → ○	—
Seeking	○	☀
Preparing to write	○	☀
Writing	○	●
Writing (test mode)	○	☀
Reading	○	○

● Lit: Orange  
○ Lit: Green

☀ Blinking: Orange  
☀ Blinking: Green

—: Off

# CRW8824S Specifications

**Supported Formats**

	Write	Read	Play
CD-DA	●	●	● (*4)
CD-G	●	●	
CD TEXT	●	●	
CD-ROM (*1)	●	●	
Mixed Mode CD-ROM (CD-ROM+CD-DA)	●	●	● (*4)
CD-ROM XA (*1)	●	●	● (*4)
Photo CD (*1)	● (*2)	●	● (*4)
Video CD	●	●	● (*4)
CD-i	●	● (*3)	
CD EXTRA	●	●	● (*4)

\*1: includes multisession    \*2: suitable disc required    \*3: suitable application software required    \*4: suitable application software required for playback

(Note) Excludes ADPCM Encode/Decode & Video Encode/Decode functions

**Writing Methods**

- Disc-at-Once (DAO)
- Session-at-Once (SAO)
- Track-at-Once (TAO)
- Packet writing

**Writing/Reading Speed**

**Writing**

CD-R    1X, 4X, 6X, 8X  
 CD-RW    2X, 4X, 8X

**Reading**

24X (max) Full CAV  
 (Note) • Data 10X-24X  
 • CD-DA extraction: 24X (max)  
 • Drive can play CD-DA at 1X speed only.  
 • Video CD: 6.9X (max)  
 • Disc (session closed): 24X (max)  
     (12X max for packet writing)  
 • Disc (session not closed): 8X (max)

**CD-R**

1X, 4X, 6X, 8X Writing: Orange Book Part II Ver.3.1-specified WO disc  
 (Note) When writing at 6X or 8X speed, use discs made for high speed recording.

**CD-RW**

2X, 4X Writing/ReWriting: Orange Book Part III Vol.1 Version 2.0-specified RW discs  
 4X, 8X Writing/ReWriting: Orange Book Part III Vol.2 Version 1.0 -specified RW discs  
 (Note) When writing at 2X speed, Orange Book Part III Vol.1 Version 1.0-specified RW discs available.

**Data Capacity**

700MB (79 min.)  
 650MB (74 min.)  
 550MB (63 min.)

**Data Transfer Rate**

1X: 150 KB/sec	8X: 1,200 KB/sec
2X: 300 KB/sec	10X: 1,500 KB/sec
4X: 600 KB/sec	16X: 2,400 KB/sec
6X: 900 KB/sec	24X: 3,600 KB/sec

**Burst Transfer Rate**

5MB/sec (max) (asynchronous)  
 20MB/sec (max) (synchronous)

<b>Data Buffer Size</b>	4MB (1,332 sectors)
<b>Average Random Access Time</b>	140 msec (reading)
<b>Sector Size</b>	2,048 ~ 2,352 B 512 B (read only)
<b>Interface</b>	SCSI-3 (Ultra SCSI)
<b>Installing style</b>	Horizontal
<b>Disc Loading Type</b>	Tray loading
<b>Audio Out</b>	Line Out Frequency Range: 20 ~ 20,000Hz Output Level: 1 Vrms
<b>Power Consumption</b>	11W (when writing or reading)
<b>Power Supply</b>	5V DC $\pm 5\%$ 12V DC $\pm 10\%$
<b>Operating Environment</b>	Temperature +5 ~ +40°C Humidity 25 ~ 80% RH (no condensation)
<b>Dimension</b>	Width: 148.0 mm Height: 42.6 mm Depth: 198.1 mm
<b>Weight</b>	0.95 kg

### The CRW8824S series complies with the following specifications

Country / Region	Compliance Specifications			Details
	Category	Item	Standards	
USA	Safety	Electrical	UL1950	Information Technology Equipment
		Laser	21CFR1040.10 FDA Chapter 1, Subchapter J	Class 1 Laser Product
	EMC	Emission	47CFR15 FCC Part 15, Subpart B	Class B Computing Device
Canada	Safety	Electrical	CSA C22.2 No. 950	Information Technology Equipment
	EMC	Emission	ICES-003	Class B Computing Device
EU	Safety	Electrical	EN60950	Information Technology Equipment
		Laser	EN60825	Class 1 Laser Product
	EMC	Immunity	EN55024	Residential, Commercial and Light Industrial Areas
		Emission	EN55022	Class B Equipment
Australia New Zealand	EMC	Emission	AS/NZ 3548	Class B Equipment
Japan	EMC	Emission	VCCI	Class B Equipment



**Index****Symbols**

4-pin power cable ..... 19, 27

**A**

Active Desktop ..... 34

additional drive ..... 13

audio cable ..... 18, 26

AUDIO OUT ..... 7

**B**

BIOS ..... 32

block size ..... 7, 12

Buffer Underrun ..... 34

**C**

CD-DA ..... 5

CD-R discs ..... 4

CD-RW discs ..... 4

**D**

Data CD ..... 5

DC INPUT ..... 7

Device Manager ..... 21, 29

disc tray ..... 6

Disc-at-Once (DAO) ..... 35

**E**

Eject button ..... 6

Ejecting the Disc ..... 30

**F**

firmware ..... 37

front panel ..... 6

**H**

headphone jack ..... 6

headphone volume control ..... 6

High Speed CD-RW discs ..... 4

**I**

ID Select ..... 7, 10

IDE cable ..... 23

**J**

jumper switches ..... 9

**L**

lead-in ..... 35

lead-out ..... 35

loading a disc ..... 30

Long-Nosed Pliers ..... 5

lug ..... 18, 26

**M**

manual eject hole ..... 6, 31

Multisession ..... 35

**O**

ON/DISC LED ..... 6

**P**

Packet Writing ..... 36

packet ..... 36

paper clip ..... 31

parity ..... 7, 11

Phillips Screwdriver ..... 5

power connector ..... 23

**R**

READ/WRITE LED ..... 6

rear panel ..... 7

replacement drive ..... 13

**S**

SCSI adapter card ..... 17, 25

SCSI connector ..... 7

SCSI driver ..... 32

SCSI flat cable ..... 17, 25

SCSI ID number ..... 10

serial number ..... 8

Session-at-Once (SAO) ..... 36

shunt ..... 9

sound card ..... 18, 26

static charge ..... 15, 23

**T**

termination ..... 11

terminator ..... 7, 11

Track-at-Once (TAO) ..... 35

**V**

Video CD ..... 5

# Distributors and Head Offices / Vertriebs- und Hauptgeschäftsstelle Distributeurs et sièges sociaux / Distribuidores y Casas matrices

If you have any questions, please contact your dealer or one of the following companies.

Pour plus de détails sur les produits, veuillez vous adresser à Yamaha ou au distributeur le plus proche figurant dans la liste suivante :

Bei weiteren Fragen wenden Sie sich bitte an Ihren Händler oder eine der folgenden Firmen.

Si tiene alguna pregunta, por favor póngase en contacto con su distribuidor o una de las siguientes empresas:

## EUROPE, EASTERN EUROPE and RUSSIA

Yamaha EUROPA GmbH  
Yamaha Systems Technology EUROPE  
Siemensstrasse 22-34,  
D-25462 Rellingen, GERMANY

TEL: +80092624222

(AUSTRIA, BELGIUM, DENMARK,  
FINLAND, FRANCE, GERMANY,  
HUNGARY, ICELAND, IRELAND, ITALY,  
LUXEMBOURG, NETHERLANDS,  
NORWAY, PORTUGAL, SPAIN, SWEDEN,  
SWITZERLAND, UNITED KINGDOM)

TEL: +80093067 (MONACO)

TEL: +3214400793

(ANDORRA, BOSNIA HERZEGOVINA,  
BULGARIA, CROATIA, CZECH REPUBLIC,  
ESTONIA, GREECE, LETLAND,  
LIECHTENSTEIN, LITHUANIA, MALTA,  
MOLDAVIA, POLAND, ROMANIA,  
RUSSIA, SLOVAKIA, SLOVENIA, TURKEY,  
UKRAINE, WHITE RUSSIA, YUGOSLAVIA)

URL: <http://www.yamaha-yste.com/>

## U.S.A.

Yamaha Corporation of America  
Consumer Products Division

6600 Orangethorpe Ave.

Buena Park, CA 90620, U.S.A.

TEL: +1 714 522 9011

FAX: +1 714 228 3913

URL: <http://www.yamaha.com/>

## CANADA

Yamaha Canada Music Ltd.

135 Milner Avenue, Scarborough,

Ontario M1S 3R1, CANADA

TEL: +1 416 298 1331

FAX: +1 416 292 0732

## AUSTRALIA

Yamaha Music Australia Pty., Ltd.

Level 1, 99 Queensbridge Street

Southbank, Victoria 3006

AUSTRALIA

TEL: +61 3 9693 5111

FAX: +61 3 9699 2332

## SINGAPORE, MALAYSIA, THAILAND, PHILIPPINES, INDIA, VIETNAM, CAMBODIA, MYANMAR, INDONESIA and IRAN

Yamaha Electronics Asia Pte Ltd.

138 Cecil Street

#05-02/03 Cecil Court, Singapore 069538

SINGAPORE

TEL: +65 223 3992

FAX: +65 223 9810

## TAIWAN

Yamaha KHS Music Co., Ltd.

11F No.150, Tun Hua North Rd.

Taipei, TAIWAN R.O.C.

TEL: +886 2 2713 8999

FAX: +886 2 2713 8666

URL: <http://www.yamahakhs.com/>

## JAPAN

Yamaha Corporation

AV & IT Business Group

IT Sales & Marketing Division

203 Matsunokijima, Toyooka-mura, Iwata-gun,

Shizuoka-ken, 438-0192 JAPAN

TEL: +81 539 62 6558

FAX: +81 539 62 5346

URL: <http://www.yamaha.co.jp/english/>



YAMAHA CORPORATION  
2nd edition (June 2000)

XY691B0 Printed in Malaysia