

Ordering Information

Body	Family S	Lamps 2 2 = 2 Lamps Per 4-Foot Section	Wattage 28 = 28 Watt 54 = 54 Watt	Style CW CW= Suspended with Wings	Length 4 4 = 4 Foot Nominal	Finish SC = Platinum WH = White
------	--------------------	--	---	---	---	---

Complete Ordering Instructions below.

Features

- Housing:** Aluminum extruded upto 4-foot nominal lengths.
- Lamp:** T5 linear fluorescent, 28 or 54 watt. (by others).
- Reflector:** Die-formed high reflectance semi-specular aluminum.
- Lens:** Translucent matte white acrylic, 0.20" (0.51cm) thick.

Electrical

Ballast is electronic, low harmonic distortion, high power and ballast factor, universal voltage with two conductors and a ground. Mark X dimming (no extra control wire required) is available. EM battery pack not available. Modules can be continuously wired row mounted, but cannot exceed amperage limits of electrical supply cords. Cable suspended fixtures have 18/3 SJT cord, stem products have three 18 gauge wires provided in stem, and both versions must be hard wired. Factory installed ballast disconnect allows the ballast to be disconnected from and reconnected to incoming power under load without turning the entire circuit off.

Mounting

Cable mounting utilize 1/16" (0.16cm) diameter SSTL aircraft cable, and are continuously adjustable via a cable gripper. Stem mountings utilize 1/8 IP stems (three wires only) with ball swivel mounting at ceiling line. Stems cannot be cut in field and should be ordered to required length. 4-1/2" (11.43cm) diameter canopies are used on both styles. 12-foot fixtures may have up to 1/4" (0.64) deflection in luminaire housings.

Finish

Powder coated Steelcase Platinum or White baked enamel.
Custom colors available, consult factory.

Labels

UL (1598), cUL and I.B.E.W.

Ordering Instructions

Individual fixtures:

- Order number of Modules required.
- Order one End Set per module.

Continuous Rows:

- Determine run length.
- Order the appropriate number of Modules to complete the run.
- Order one End Set per run.
- Order one Intermediate suspension per Module minus one per run.
- For runs that exceed amperage limits, order the appropriate number of Intermediate suspension Power (for cable suspended units only).

Job Information

Type:

Job Name:

Cat. No.:

Lamp(s):

Notes:

631 Airport Road, Fall River, MA 02720 • (508) 679-8131 • Fax (508) 674-4710
We reserve the right to change details of design, materials and finish.
www.lightolier.com © 2008 Philips Group • B0908

Performance

CANDLEPOWER CURVE

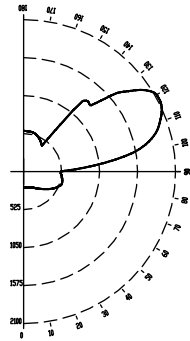

ZONE	CANDLEPOWER				
	0	22	45	67	90
	CANDELAS				
DEG.					
180	563	563	563	563	563
175	564	564	563	561	560
165	548	549	552	554	553
155	537	538	527	511	506
145	554	546	503	448	442
135	556	535	480	1264	1299
125	546	519	1087	1754	1968
115	515	701	1546	1991	2106
105	438	852	1488	1770	1851
95	156	645	873	975	986
90	2	221	406	484	516
85	23	216	402	495	525
75	73	198	412	521	552
65	107	183	350	470	511
55	134	172	288	384	421
45	156	179	245	311	338
35	182	193	222	261	279
25	204	209	223	238	243
15	216	218	222	227	229
5	222	222	222	222	221
0	221	221	221	221	221

REPORT NO.: ITL54090
 LAMPS: 2-F54T5
 LUMENS: 5000
 EFFICIENCY: 78.9%
 CAT NO.: S254CW4WH

COEFFICIENTS OF UTILIZATION

% EFFECTIVE CEILING CAVITY REFLECTANCE

	WALL REFLECTANCE								
	80%			70%			50%		
	70	50	30	70	50	30	50	30	10
0	80	80	80	71	71	71	54	54	54
1	71	66	63	62	59	56	44	42	40
2	63	57	52	45	50	46	38	35	32
3	57	49	43	50	44	38	33	29	26
4	52	43	37	46	38	33	29	25	21
5	48	38	32	42	34	28	25	21	18
6	44	34	27	38	30	24	23	18	15
7	40	30	24	35	27	21	20	16	13
8	37	27	21	33	24	19	18	14	12
9	34	25	19	30	22	17	17	13	10
10	32	23	17	28	20	15	15	12	9

20% FLOOR CAVITY REFLECTANCE

DISTRIBUTION

Zone	Lumens	% Lamp	% Luminaire
0-90	1855	18.5	23.5
90-180	6032	60.3	76.5
0-180	7887	78.9	100.0

Fixture Lengths & Mounting Locations

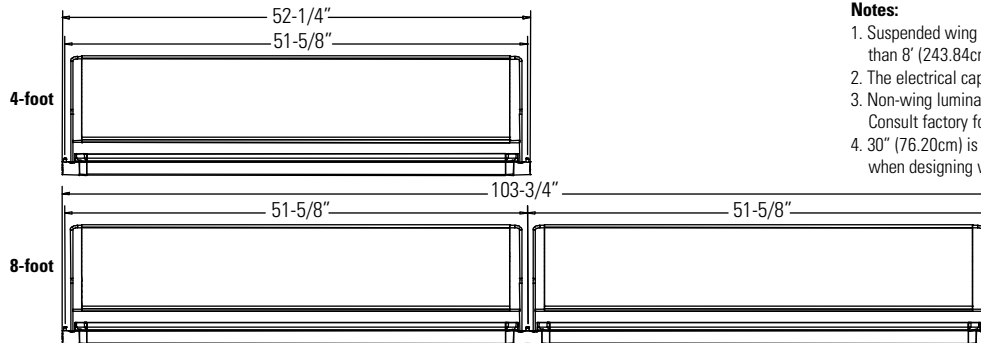

Notes:

- Suspended wing luminaires can be continuously row mounted longer than 8' (243.84cm) (but all fixtures must be 4-foot nominal units).
- The electrical capacity of power cords cannot be exceeded.
- Non-wing luminaires can be added to the continuous rows if desired. Consult factory for details.
- 30" (76.20cm) is the minimum recommended mounting distance when designing with Wing luminaires.

Mounting Accessories

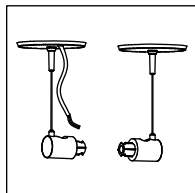

Power Feed Cable End Set

Distance is from the ceiling line to the top of the luminaire housing.

36" Platinum: **SECW36SC**
 36" White: **SECW36WH**

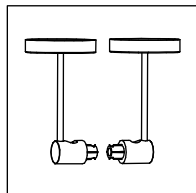

Stem End Set

Distance is from the ceiling line to the top of the luminaire housing.

30" Platinum: **SESW30SC**
 30" White: **SESW30WH**

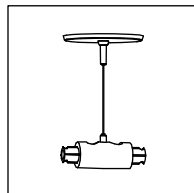

Intermediate Cable

Distance is from the ceiling line to the top of the luminaire housing.

36" Platinum: **SICW36SC**
 36" White: **SICW36WH**

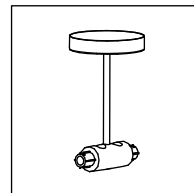

Intermediate Stem

Distance is from the ceiling line to the top of the luminaire housing.

30" Platinum: **SISW30SC**
 30" White: **SISW30WH**

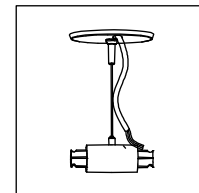

Intermediate Cable/Cord

Distance is from the ceiling line to the top of the luminaire housing.

36" Platinum: **SIPW36SC**
 36" White: **SIPW36WH**

Job Information

Type:

631 Airport Road, Fall River, MA 02720 • (508) 679-8131 • Fax (508) 674-4710
 We reserve the right to change details of design, materials and finish.
 www.lightolier.com © 2008 Philips Group • B0908