



2 Lamps





Compact Fluorescent Integrated Lamps





Essential 18W



Attractive value

Good value for money

- Trusted quality energy savers for best performance
- Choice of light colours
- New lamp cap design for a refined, more sophisticated appearance with embossed Philips marking

Up to 80% energy saving

- The Essential range can replace the full incandescent range from 40W up to 125W up to 80% energy saving

Long Life: 6 years

- Long reliable life of up to 6000 hrs, which is 6 times longer when compared to standard incandescent lamps
- 1 year guarantee
- Safety fuse for flicker free start

Best environmental choice

- The Essential range is fully RoHS compliant, conforming to the most strict environmental legislation in the world

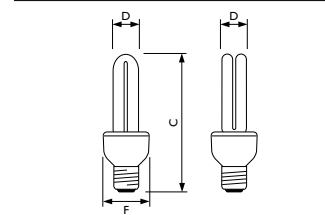

Essential 8W-14W

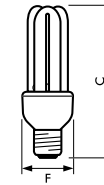

Essential 18W-23W

Dimensions in mm	C	F
	max.	max.
Essential 8W	140	44
Essential 11W	155	44
Essential 14W	170	44
Essential 18W	165	52
Essential 23W	175	52

Applications

- The Essential range is widely used to replace incandescent light
- Enclosed luminaires are required for outdoor use
- Not suitable for dimmers, electronic switches or remote controls

Preferred selection

Product ID	Lamp Wattage (W)	Cap/ Base (V)	Lamp Voltage (V)	Frequency (Hz)	Colour Temperature (K)	Luminous Flux (Lm)	Luminous Efficacy (Lm/W)	Colour Rendering Index (Ra)	Equivalent light of ordinary Incandescent	Box quantity	Order Code
Cool Daylight											
Essential	8W	E27	220-240V	50-60Hz	6500	440	55	80	40W	12	39591315
Essential	8W	B22	220-240V	50-60Hz	6500	440	55	80	40W	12	39593715
Essential	11W	E27	220-240V	50-60Hz	6500	620	56	80	60W	12	39595115
Essential	11W	B22	220-240V	50-60Hz	6500	620	56	80	60W	12	39597515
Essential	14W	E27	220-240V	50-60Hz	6500	820	59	80	75W	12	39599915
Essential	14W	B22	220-240V	50-60Hz	6500	820	59	80	75W	12	39601915
Essential	18W	E27	220-240V	50-60Hz	6500	1100	61	80	100W	12	39603315
Essential	18W	B22	220-240V	50-60Hz	6500	1100	61	80	100W	12	39605715
Essential	23W	E27	220-240V	50-60Hz	6500	1420	62	80	125W	12	39607115
Essential	23W	B22	220-240V	50-60Hz	6500	1420	62	80	125W	12	39609515

Warm White

Essential	8W	E27	220-240V	50-60Hz	2700	460	58	82	40W	12	39590615
Essential	8W	B22	220-240V	50-60Hz	2700	460	58	82	40W	12	39592015
Essential	11W	E27	220-240V	50-60Hz	2700	650	59	82	60W	12	39594415
Essential	11W	B22	220-240V	50-60Hz	2700	650	59	82	60W	12	39596815
Essential	14W	E27	220-240V	50-60Hz	2700	860	61	82	75W	12	39598215
Essential	14W	B22	220-240V	50-60Hz	2700	860	61	82	75W	12	39600215
Essential	18W	E27	220-240V	50-60Hz	2700	1170	65	82	100W	12	39602615
Essential	18W	B22	220-240V	50-60Hz	2700	1170	65	82	100W	12	39604015
Essential	23W	E27	220-240V	50-60Hz	2700	1460	63	82	125W	12	39606415
Essential	23W	B22	220-240V	50-60Hz	2700	1460	63	82	125W	12	39608815

Essential 12V Direct Current

Economy



Essential 12V



A perfect light in remote areas

Perfect suitable for remote areas

- The lamps operate on a simple 6-13V battery, enabling you to have light also in remote rural areas with limited power supply
- The Essential 12V DC can be directly used in combination with solar panels

Up to 80% energy saving

- The Essential 12V DC lamps offer you the additional benefit of up to 80% less energy consumption when compared to standard incandescent lamps

Long Life: 6 Years

- Long and reliable life of 6000 hrs, which is up to 6 times longer when compared to incandescent lamps

Essential 12V Direct Current

Economy

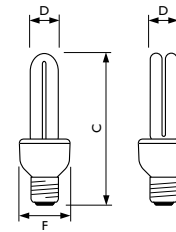

Essential 12V

Dimensions in mm	C	F
Essential DC6W	125	44
Essential DC11W	155	44

Applications

- The Essential 12V DC is perfectly suitable in applications with low voltage power supply like busses, ships and cars and in combination with solar panels

Preferred selection

Product ID	Lamp Wattage	Cap/ Base	Lamp Voltage	Frequency	Colour Temp.	Lumen Output	Luminous Efficacy	Colour Rendering Index	Box quantity	Incandescent Equivalent	Order Code
	(W)		(V)	(Hz)		(Lm)	(Lm/W)	(R _a)			8710163
Cool Daylight											
Essential DC	6W	E27	10-13V	50-60Hz	6500	250	41	80	6	25W	21027810
Essential DC	6W	B22	10-13V	50-60Hz	6500	250	41	80	6	25W	21043810
Essential DC	11W	E27	10-13V	50-60Hz	6500	580	52	80	6	60W	21028510
Essential DC	11W	B22	10-13V	50-60Hz	6500	580	52	80	6	60W	21044510

Warm White

Essential DC	6W	E27	10-13V	50-60Hz	2700	280	46	82	6	25W	21039110
Essential DC	6W	B22	10-13V	50-60Hz	2700	280	46	82	6	25W	21041410
Essential DC	11W	E27	10-13V	50-60Hz	2700	600	54	82	6	60W	21040710
Essential DC	11W	B22	10-13V	50-60Hz	2700	600	54	82	6	60W	21042110

Essential Long life

Economy



Essential Long Life



Very attractive value

Good value for money

- Trusted quality energy savers for long and reliable performance
- Frequent turning on/off up to 15000 times for long life
- Choice of colours

Up to 80% energy saving

- The Essential Long Life range is available in 20W and 23W in high voltage replacing 100W and 125W incandescent equivalents for up to 80% energy saving

Long life: 12 Years

- Long and reliable life of 12000 hrs, which is up to 12 times longer when compared to incandescent lamps
- 1 year guarantee
- Safety fuse and flicker free start

Best Environmental choice

- The Essential Long Life range is fully RoHS compliant conforming to the most strict environmental legislation in the world

Essential Long life

Economy

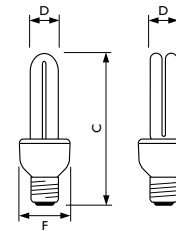

Essential Long Life

Dimensions in mm	C	F
	max.	max.
Essential Long Life 20W	165	52
Essential Long Life 23W	175	52

Applications

- The Essential Long Life range is widely used to replace incandescent lamp
- The long life time and 15000 switching cycles is ideal for applications where lamps are frequently switched on and off
- Enclosed luminaires are required for outdoor use
- Not suitable for dimmers and electronic devices

Preferred selection

Product ID	Lamp Wattage	Cap/ Base	Lamp Voltage	Frequency	Colour Temp.	Luminous Flux	Luminous Efficacy	Colour Rendering Index	Incandescent Equivalent	Box quantity	Order Code
	(W)	(V)	(Hz)	(K)	(lm)	(Lm/w)	(R _a)				8710163
Cool Daylight											
Essential Long Life	20W	E27	220-240V	50-60Hz	6500	1200	62	80	100W	12	39689715
Essential Long Life	20W	B22	220-240V	50-60Hz	6500	1200	62	80	100W	12	39693415
Essential Long Life	23W	E27	220-240V	50-60Hz	6500	1420	62	80	125W	12	39691015
Essential Long Life	23W	B22	220-240V	50-60Hz	6500	1420	62	80	125W	12	39695815

Warm White

Essential Long Life	20W	E27	220-240V	50-60Hz	2700	1250	65	82	100W	12	39688015
Essential Long Life	20W	B22	220-240V	50-60Hz	2700	1250	65	82	100W	12	39692715
Essential Long Life	23W	E27	220-240V	50-60Hz	2700	1460	63	82	125W	12	39690315
Essential Long Life	23W	B22	220-240V	50-60Hz	2700	1460	63	82	125W	12	39694115



Genie 14W/18W



A small lamp for big energy saving

Small size, fits any lamp shade in your home

- The Genie range is the top choice due to its small and compact size
- 20% smaller when compared to the Essential range, for perfect fit in small luminaires
- New lamp cap design for a refined, more sophisticated appearance with embossed Philips marking

Up to 80% energy saving

- The Genie range can replace the full incandescent range from 25W up to 100W for energy saving of up to 80%

Long Life: 8 years

- Up to 8 times longer when compared to normal incandescent lamps
- 1 year guarantee
- Safety fuse for instant and flicker free start

Best environmental choice

- The Genie range is fully RoHS compliant, conforming to the most strict environmental legislation in the world

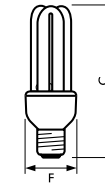

Genie

Dimensions in mm	C	F
Genie 5W	105	37
Genie 8W	105	44
Genie 11W	115	44
Genie 14W	130	44
Genie 18W	133	48

Applications

- The Genie range is widely used to replace incandescent light bulbs in indoor fixtures, table fixtures and other consumer or (semi) professional applications that require small sized lamps
- Enclosed luminaires are required for outdoor use
- Not suitable for dimmers, electronic switches or remote controls

Preferred selection

Product ID	Lamp	Cap/	Lamp	Frequency	Colour	Lumi- nous	Efficacy	Colour Render- ing	Incandescent	Box	Order
	Wattage (W)	Base	Voltage (V)	(Hz)	Temperature (K)	Flux (Lm)	(Lm/W)	Index (Ra)	Equivalent	quantity	code 8710163
Cool Daylight											
Genie	5W	E27	220-240V	50-60Hz	6500	235	47	80	25W	12	39357534
Genie	5W	E14	220-240V	50-60Hz	6500	235	47	80	25W	12	39361234
Genie	5W	B22	220-240V	50-60Hz	6500	235	47	80	25W	12	39359934
Genie	8W	E27	220-240V	50-60Hz	6500	415	52	80	40W	12	39363634
Genie	8W	E14	220-240V	50-60Hz	6500	415	52	80	40W	12	39367434
Genie	8W	B22	220-240V	50-60Hz	6500	415	52	80	40W	12	39365034
Genie	11W	E14	220-240V	50-60Hz	6500	600	54	80	60W	12	39373534
Genie	11W	E27	220-240V	50-60Hz	6500	600	54	80	60W	12	39369834
Genie	11W	B22	220-240V	50-60Hz	6500	600	54	80	60W	12	39371134
Genie	14W	E27	220-240V	50-60Hz	6500	790	56	80	75W	12	39375934
Genie	14W	B22	220-240V	50-60Hz	6500	790	56	80	75W	12	39377334
Genie	18W	E27	220-240V	50-60Hz	6500	1040	58	80	100W	12	39379734
Genie	18W	B22	220-240V	50-60Hz	6500	1040	58	80	100W	12	39381034

Warm White

Genie	5W	E27	220-240V	50-60Hz	2700	250	50	82	25W	12	39356834
Genie	5W	E14	220-240V	50-60Hz	2700	250	50	82	25W	12	39360534
Genie	5W	B22	220-240V	50-60Hz	2700	250	50	82	25W	12	39358234
Genie	8W	E27	220-240V	50-60Hz	2700	440	55	82	40W	12	39362934
Genie	8W	E14	220-240V	50-60Hz	2700	440	55	82	40W	12	39366734
Genie	8W	B22	220-240V	50-60Hz	2700	440	55	82	40W	12	39364334
Genie	11W	E14	220-240V	50-60Hz	2700	610	55	82	60W	12	39372834
Genie	11W	E27	220-240V	50-60Hz	2700	610	55	82	60W	12	39368134
Genie	11W	B22	220-240V	50-60Hz	2700	610	55	82	60W	12	39370434
Genie	14W	E27	220-240V	50-60Hz	2700	840	60	82	75W	12	39374234
Genie	14W	B22	220-240V	50-60Hz	2700	840	60	82	75W	12	39376634
Genie	18W	E27	220-240V	50-60Hz	2700	1100	61	82	100W	12	39378034
Genie	18W	B22	220-240V	50-60Hz	2700	1100	61	82	100W	12	39380334

Genie Long Life

Compact



Genie Long Life



A welcome light, savings in sight

Top-level performance, High switches

- Compact high quality energy saver for extra long and reliable performance
- Frequent turning on/off, up to 15000 times for long life

Up to 80% energy saving

- The Genie Long Life range can replace 25W up to 75W incandescent equivalents for energy savings of up to 80%

Long life: 12 Years

- Up to 12 times longer when compared to incandescent lamp, for less maintenance and replacements costs
- 1 year guarantee
- Safety fuse and flicker free start

Best environmental choice

- The Genie Long Life range is fully RoHS compliant conforming to the most strict environmental legislation in the world

Genie Long Life

Compact

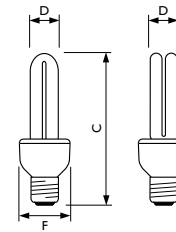

Genie Long Life

Dimensions in mm	C	F
Genie Long Life E27/B22 5W	105	37
Genie Long Life E27/B22 8W	105	44
Genie Long Life E27/B22 11W	115	44
Genie Long Life E27/B22 14W	130	44
Genie Long Life E27/B22 18W	133	48

Applications

- The Genie Long Life range is widely used to replace incandescent lamp
- The long lifetime and 15000 switching cycles is ideal for applications where lamps are frequently switched on/off. Especially suitable for hotel applications like lobby, rooms, corridors, restaurant
- Enclosed luminaires are required for outdoor use
- Not suitable for dimmers

Preferred selection

Product ID	Lamp Wattage	Cap/ Base	Lamp Voltage	Frequency	Colour Temp.	Luminous Flux	Luminous Efficacy	Colour Rendering Index	Incandescent Equivalent	Box quantity	Order Code
	(W)	(V)	(Hz)	(K)	(Lm)	(Lm/W)	(R _a)		pcs	8710163	
Cool Daylight											
Genie Long Life	5W	E27	220-240V	50-60Hz	6500	235	47	80	25W	48	39705415
Genie Long Life	5W	B22	220-240V	50-60Hz	6500	235	47	80	25W	48	39713915
Genie Long Life	8W	E27	220-240V	50-60Hz	6500	415	52	80	40W	48	39707815
Genie Long Life	8W	B22	220-240V	50-60Hz	6500	415	52	80	40W	48	39715315
Genie Long Life	11W	E27	220-240V	50-60Hz	6500	600	54	80	60W	48	39709215
Genie Long Life	11W	B22	220-240V	50-60Hz	6500	600	54	80	60W	48	39717715
Genie Long Life	14W	E27	220-240V	50-60Hz	6500	790	56	80	75W	48	39711515
Genie Long Life	14W	B22	220-240V	50-60Hz	6500	790	56	80	75W	48	39719115
Genie Long Life	18W	E27	220-240V	50-60Hz	6500	1040	58	80	100W	48	40151515
Genie Long Life	18W	B22	220-240V	50-60Hz	6500	1040	58	80	100W	48	40153915

Warm White

Genie Long Life	5W	E27	220-240V	50-60Hz	2700	250	50	82	25W	48	39704715
Genie Long Life	5W	B22	220-240V	50-60Hz	2700	250	50	82	25W	48	39712215
Genie Long Life	8W	E27	220-240V	50-60Hz	2700	440	55	82	40W	48	39706115
Genie Long Life	8W	B22	220-240V	50-60Hz	2700	440	55	82	40W	48	39714615
Genie Long Life	11W	E27	220-240V	50-60Hz	2700	610	55	82	60W	48	39708515
Genie Long Life	11W	B22	220-240V	50-60Hz	2700	610	55	82	60W	48	39716015
Genie Long Life	14W	E27	220-240V	50-60Hz	2700	840	60	82	75W	48	39710815
Genie Long Life	14W	B22	220-240V	50-60Hz	2700	840	60	82	75W	48	39718415
Genie Long Life	18W	B22	220-240V	50-60Hz	2700	1100	61	82	100W	48	40150815
Genie Long Life	18W	B22	220-240V	50-60Hz	2700	1100	61	82	100W	48	40152215

Tornado Mini

Decorative



Tornado Mini



Small with a bigger heart

More and brighter light, smallest in size

- New premium range in 5W, 8W and 12W
- 20% more and brighter light and is 25% smaller in size when compared to the Genie range
- Perfect decorative fit for small and open luminaires

Up to 80% energy saving

- The new Tornado Mini range can replace 25W up to 60W incandescent bulbs for instant energy savings of up to 80%

Long Life: 8 years

- Up to 8 times longer life when compared to normal incandescent lamps
- 1 year guarantee
- Safety fuse and flicker-free start

Best environmental choice

- The Tornado Mini range is fully RoHS compliant, conforming to the most strict environmental legislation in the world

Tornado Mini

Decorative

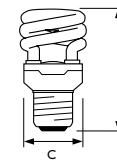

Tornado Mini 5W-12W

Dimensions in mm	C	F
Tornado Mini 5W	40	77
Tornado Mini 8W	40	84
Tornado Mini 12W	40	91

Applications

- The Tornado Mini range is widely used to replace incandescent light bulbs in all kinds of applications, especially where intensive light output is required
- Enclosed luminaires are required for outdoor use
- Not suitable for dimmers, electronic switches or remote controls

Preferred selection

Product ID	Lamp Wattage (W)	Cap/ Base	Lamp Voltage (V)	Frequency (Hz)	Colour Temp. (K)	Lumen Output (Lm)	Luminous Efficacy (Lm/W)	Rendering Index (Ra)	Box quantity pcs	Order Code
Cool Daylight										
Tornado Mini	5W	B22	220-240V	50-60Hz	6500	285	57	80	12	8710163
Tornado Mini	5W	E14	220-240V	50-60Hz	6500	285	57	80	12	39447315
Tornado Mini	5W	E27	220-240V	50-60Hz	6500	285	57	80	12	39435015
Tornado Mini	8W	B22	220-240V	50-60Hz	6500	475	59	80	12	39443515
Tornado Mini	8W	E14	220-240V	50-60Hz	6500	475	59	80	12	39449715
Tornado Mini	8W	E27	220-240V	50-60Hz	6500	475	59	80	12	39437415
Tornado Mini	12W	B22	220-240V	50-60Hz	6500	685	62	80	12	39445915
Tornado Mini	12W	E14	220-240V	50-60Hz	6500	685	62	80	12	39451015
Tornado Mini	12W	E27	220-240V	50-60Hz	6500	685	62	80	12	39439815

Warm White

Tornado Mini	5W	B22	220-240V	50-60Hz	2700	300	60	82	12	39440415
Tornado Mini	5W	E14	220-240V	50-60Hz	2700	300	60	82	12	39446615
Tornado Mini	5W	E27	220-240V	50-60Hz	2700	300	60	82	12	39434315
Tornado Mini	8W	B22	220-240V	50-60Hz	2700	500	62	82	12	39442815
Tornado Mini	8W	E14	220-240V	50-60Hz	2700	500	62	82	12	39448015
Tornado Mini	8W	E27	220-240V	50-60Hz	2700	500	62	82	12	39436715
Tornado Mini	12W	B22	220-240V	50-60Hz	2700	725	65	82	12	39444215
Tornado Mini	12W	E14	220-240V	50-60Hz	2700	725	65	82	12	39450315
Tornado Mini	12W	E27	220-240V	50-60Hz	2700	725	65	82	12	39438115

Tornado

Decorative



Tornado



The decorative lamp with high light output

More and brighter light, decorative shape

- Distinct, decorative shape, creating a modern look
- The spiral shape allows for more and better light distribution, offering up to 20% more and brighter light compared to Genie energy savers

Up to 80% energy saving

- The Tornado range can replace 60W up to 125W incandescent lamps for energy savings up to 80%

Long Life: 8 years

- Up to 8 times longer when compared to incandescent lamps
- 1 year guarantee
- Safety fuse for instant and flicker free start

Best environmental choice

- The Tornado range is fully RoHS compliant, conforming to the most strict environmental legislation in the world

Tornado

Decorative

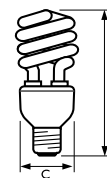

Tornado

Dimensions in mm	C	F
Tornado 11W	44	700
Tornado 15W	44	1000
Tornado 20W	48	1350
Tornado 23W	48	1550

Applications

- The Tornado range is widely used to replace incandescent light bulbs in all kinds of applications, especially where intensive light output is required
- Enclosed luminaires are required for outdoor use
- Not suitable for dimmers, electronic switches or remote controls

Preferred selection

Product ID	Lamp Wattage (W)	Cap/ Base	Lamp Voltage (V)	Frequency (Hz)	Colour Temp. (K)	Luminous Flux (Lm)	Luminous Efficacy (Lm/W)	Rendering Index (Ra)	Incandescent Equivalent	Box quantity pcs	Order Code
Cool Daylight											
Tornado	11W	B22	220-240V	50-60Hz	6500	660	60	80	60W	12	39657615
Tornado	11W	E27	220-240V	50-60Hz	6500	660	60	80	60W	12	39653815
Tornado	15W	E27	220-240V	50-60Hz	6500	950	60	80	75W	12	39655215
Tornado	15W	B22	220-240V	50-60Hz	6500	950	60	80	75W	12	39659015
Tornado	20W	E27	220-240V	50-60Hz	6500	1250	63	80	100W	12	39661315
Tornado	20W	B22	220-240V	50-60Hz	6500	1250	63	80	100W	12	39665115
Tornado	23W	E27	220-240V	50-60Hz	6500	1450	63	80	125W	12	39663715
Tornado	23W	B22	220-240V	50-60Hz	6500	1450	63	80	125W	12	39667515
Warm White											
Tornado	11W	E27	220-240V	50-60Hz	2700	700	64	82	60W	12	39652115
Tornado	11W	B22	220-240V	50-60Hz	2700	700	64	82	60W	12	39656915
Tornado	15W	E27	220-240V	50-60Hz	2700	1000	63	82	75W	12	39654515
Tornado	15W	B22	220-240V	50-60Hz	2700	1000	63	82	75W	12	39658315
Tornado	20W	E27	220-240V	50-60Hz	2700	1350	67	82	100W	12	39660615
Tornado	20W	B22	220-240V	50-60Hz	2700	1350	67	82	100W	12	39664415
Tornado	23W	E27	220-240V	50-60Hz	2700	1550	67	82	125W	12	39662015
Tornado	23W	B22	220-240V	50-60Hz	2700	1550	67	82	125W	12	39666815

Tornado Dimmable

Comfort



Tornado Dimmable



Create the perfect light level for any activity

Dim to create the perfect lighting mood

- Tornado Dimmable allows you to adjust to the light level that suits the situation like watching TV, reading, eating or entertaining friends
- Tornado Dimmable can be used on most existing conventional dimmers, no need to rewire or refit existing dimmers

Up to 80% energy savings

- An ideal replacement for incandescent bulbs allowing a dimming experience comparable to traditional incandescent bulbs, whilst saving up to 80% on energy consumption

Long Life: 8 Years

- 8000 hrs. Up to 8 times longer life when compared to incandescent lamps
- 1 year guarantee

Best Environmental choice

- Fully RoHS compliant, conforming to the most strict environmental legislation in the world

Tornado Dimmable

Comfort

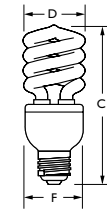

Tornado Dimmable

Dimensions in mm	C	F
	60	125

Applications

- An ideal replacement for incandescent bulbs and standard energy savers in indoor fixtures, meeting both functional and aesthetic lighting requirements. Compatible with existing wall and on-luminaire dimmers
- Ideal for living, dining rooms, bedrooms, halls and studies
- Enclosed fixtures are required for outdoor applications

Preferred selection

Product ID	Lamp Wattage (W)	Cap/ Base	Lamp Voltage (V)	Frequency (Hz)	Colour Temp. (K)	Lumen Output (Lm)	Luminous Efficacy (Lm/W)	Rendering Index (Ra)	Incandescent Equivalent	Order Code
Cool Daylight										
Tornado Dimmable	20W	E27	220-240V	50-60Hz	6500	1100	55	80	100 W	available on request
Tornado Dimmable	20W	B22	220-240V	50-60Hz	6500	1100	55	80	100 W	available on request
Warm White										
Tornado Dimmable	20W	E27	220-240V	50-60Hz	2700	1155	58	82	100 W	available on request
Tornado Dimmable	20W	B22	220-240V	50-60Hz	2700	1155	58	82	100 W	available on request

Ambiance Standard Shape

Comfort



Ambiance Standard Shape



For pleasant light effects

Attractive modern design in a classic shape

- The Ambiance range offers a decorative appeal to complement elegant, modern light fittings in homes, restaurants and hotels
- An elegant cover for a comfortable low glare light that is soft on the eyes
- In a familiar standard shape, similar in size to their incandescent equivalent

Up to 80% energy saving

- The Ambiance range with classic shape is an ideal replacement for incandescent bulbs of 25W up to 75W, saving up to 80% on energy consumption

Long Life: 6 Years

- 6000 hrs. Up to 6 times longer when compared to incandescent lamps
- 1 year guarantee, safety fuse and flicker free start

Best Environmental choice

- The Ambiance Standard range is fully RoHS compliant conforming to the most strict environmental legislation in the world

Ambiance Standard Shape

Comfort

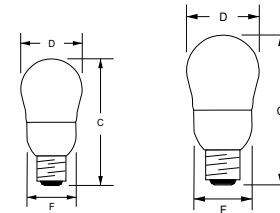

Ambiance
5W-11W

Ambiance
14W-18W

Dimensions in mm	C	F
5W	106	45
8W	106	45
11W	106	45
14W	106	50
18W	106	50

Applications

- Designed for replacement of incandescent lamps in standard shape for decorative and functional indoor applications
- Enclosed fixtures are required for outdoor applications
- Not suitable for dimming and electronic devices

Preferred selection

Product ID	Lamp Wattage	Cap/ Base*	Lamp Voltage	Frequency	Colour Temperature	Colour Rendering Index	Light Output	Efficacy	Dimmable	Order Code
	(W)		(V)	(Hz)	(K)	(R _a)	(Lumen)	(Lm/W)		8710163
Cool Daylight										
Ambiance	5W	E27	220-240V	50-60Hz	6500	80	190	38	No	40163815
Ambiance	5W	B22	220-240V	50-60Hz	6500	80	190	38	No	40165215
Ambiance	8W	E27	220-240V	50-60Hz	6500	80	380	47	No	40167615
Ambiance	8W	B22	220-240V	50-60Hz	6500	80	380	47	No	40169015
Ambiance	11W	E27	220-240V	50-60Hz	6500	80	540	49	No	40171315
Ambiance	11W	B22	220-240V	50-60Hz	6500	80	540	49	No	40173715
Ambiance	14W	E27	220-240V	50-60Hz	6500	80	780	56	No	40211610
Ambiance	14W	B22	220-240V	50-60Hz	6500	80	780	56	No	40213010
Ambiance	18W	E27	220-240V	50-60Hz	6500	80	1000	56	No	40215410
Ambiance	18W	B22	220-240V	50-60Hz	6500	80	1000	56	No	40217810
Warm White										
Ambiance	5W	E27	220-240V	50-60Hz	2700	82	200	40	No	40162115
Ambiance	5W	B22	220-240V	50-60Hz	2700	82	200	40	No	40164515
Ambiance	8W	E27	220-240V	50-60Hz	2700	82	400	50	No	40166915
Ambiance	8W	B22	220-240V	50-60Hz	2700	82	400	50	No	40168315
Ambiance	11W	E27	220-240V	50-60Hz	2700	82	570	51	No	40170615
Ambiance	11W	B22	220-240V	50-60Hz	2700	82	570	51	No	40172015
Ambiance	14W	E27	220-240V	50-60Hz	2700	82	820	59	No	40210910
Ambiance	14W	B22	220-240V	50-60Hz	2700	82	820	59	No	40212310
Ambiance	18W	E27	220-240V	50-60Hz	2700	82	1050	58	No	40214710
Ambiance	18W	B22	220-240V	50-60Hz	2700	82	1050	58	No	40216110

Ambiance Coloured

Decorative



Ambiance Coloured



For pleasant light effects

A choice of very attractive colours

- Coloured decorative energy-saving range is available in four bright colours: red, green, yellow and blue
- For original lighting effects and decorative ambiances for a multitude of occasions and applications

Colours that save up to 80% on energy

- The Ambiance Coloured range brings you both colours and energy savings up to 80%
- Long reliable life up to 6000 hrs which is up to 6 times longer life compared to normal incandescent lamps

Suitable for many application areas

- Ambiance Coloured energy savers can be used in a wide range of decorative applications, both outdoor and indoor, e.g. streets, facades, shopping centres, parties and special celebrations
- Not suitable for dimming and electronic devices

Ambiance Coloured

Decorative

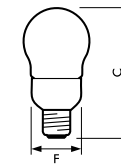

Ambiance Coloured

Dimensions in mm	C	F
Ambiance Coloured	124	44

Ambiance Coloured

Wattage	Cap/ Base	Voltage	Bulb Shape	Frequency	Colour	Box quantity	Dimmable	Order Code
(W)		(V)		(Hz)				8710163
Ambiance Coloured 11W	E27	220-240	A60	50-60	Blue	6	No	15728310
Ambiance Coloured 11W	B22	220-240	A60	50-60	Blue	6	No	21019315
Ambiance Coloured 11W	E27	220-240	A60	50-60	Green	6	No	15727610
Ambiance Coloured 11W	B22	220-240	A60	50-60	Green	6	No	21018615
Ambiance Coloured 11W	E27	220-240	A60	50-60	Red	6	No	15725210
Ambiance Coloured 11W	B22	220-240	A60	50-60	Red	6	No	21016215
Ambiance Coloured 11W	E27	220-240	A60	50-60	Yellow	6	No	15726910
Ambiance Coloured 11W	B22	220-240	A60	50-60	Yellow	6	No	21017915

Ambiance Reflector

Focus



Ambiance Reflector



Focussed light

Energy-saving solution for directional light

- An ideal energy saving replacement for incandescent reflector bulbs in indoor fixtures that give focused lighting effects

Up to 80% energy saving

- The Reflector range is available in the exact same diameters as their incandescent equivalent, allowing for immediate saving of up to 80% on energy consumption

Long Life: 6 Years

- 6000 hrs. Up to 6 times longer when compared to incandescent lamps
- 1 year guarantee

Best Environmental choice

- The Ambiance Reflector range is fully RoHS compliant conforming to the most strict environmental legislation in the world

Ambiance Reflector

Focus

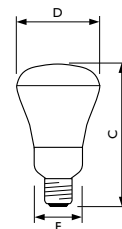

Ambiance Reflector

Dimensions in mm	C	F
8W R60	114	44
11W R63	124	44
14W R80	130	50
18W R80	144	50

Applications

- Designed for replacement of incandescent and halogen reflector lamps in downlighters in home and more professional applications like shops, restaurants, cafés
- Not suitable for dimming and electronic devices

Preferred selection

Product ID	Lamp Watt.	Cap/ Base	Bulb Shape	Lamp Voltage	Freq.	Colour Temp.	Colour Rendering Index	Beam Angle	Light Output	Efficacy	Packaging Type / config.	Life time	Dim.	Order Code
	(W)		(V)	(Hz)	(K)	(Ra)	(degrees)	(Lumen)	(Lm/W)		(hrs)		8710163	
Cool Daylight														
Ambiance Ref.	8W	E27	R63	220-240V	50-60Hz	6500	80	120	265	33	ICT/12	6000	No	40223915
Ambiance Ref.	8W	B22	R63	220-240V	50-60Hz	6500	80	120	265	33	ICT/12	6000	No	40225315
Ambiance Ref.	11W	E27	R63	220-240V	50-60Hz	6500	80	120	365	33	ICT/12	6000	No	40227715
Ambiance Ref.	11W	B22	R63	220-240V	50-60Hz	6500	80	120	365	33	ICT/12	6000	No	40229115
Ambiance Ref.	14W	E27	R80	220-240V	50-60Hz	6500	80	120	585	42	ICT/6	6000	No	40231410
Ambiance Ref.	14W	B22	R80	220-240V	50-60Hz	6500	80	120	585	42	ICT/6	6000	No	40233810
Ambiance Ref.	18W	E27	R95	220-240V	50-60Hz	6500	80	120	800	45	ICT/6	6000	No	40235210
Ambiance Ref.	18W	B22	R95	220-240V	50-60Hz	6500	80	120	800	45	ICT/6	6000	No	40237610

Warm White

Ambiance Ref.	8W	E27	R63	220-240V	50-60Hz	2700	82	120	280	35	ICT/12	6000	No	40222215
Ambiance Ref.	8W	B22	R63	220-240V	50-60Hz	2700	82	120	280	35	ICT/12	6000	No	40224615
Ambiance Ref.	11W	E27	R63	220-240V	50-60Hz	2700	82	120	385	35	ICT/12	6000	No	40226015
Ambiance Ref.	11W	B22	R63	220-240V	50-60Hz	2700	82	120	385	35	ICT/12	6000	No	40228415
Ambiance Ref.	14W	E27	R80	220-240V	50-60Hz	2700	82	120	615	44	ICT/6	6000	No	40230710
Ambiance Ref.	14W	B22	R80	220-240V	50-60Hz	2700	82	120	615	44	ICT/6	6000	No	40232110
Ambiance Ref.	18W	E27	R95	220-240V	50-60Hz	2700	82	120	840	47	ICT/6	6000	No	40234510
Ambiance Ref.	18W	B22	R95	220-240V	50-60Hz	2700	82	120	840	47	ICT/6	6000	No	40236910

Ambiance Reflector PAR38

Wide beam



Ambiance Reflector PAR38



Save energy outdoors

Same size, Wide beam

- Same size as the PAR38 incandescent equivalent, not fit issues in existing luminaires
- Wide beam angle of 120°
- Hard glass makes the lamps suitable for outdoor use

Up to 80% energy saving

- For savings of up to 80% energy as you can directly replace 80W and 120W PAR38 incandescent lamps

Long Life: 6 Years

- Reliable life of 6000 hrs, which is up to 6 times longer when compared to incandescent lamps
- 1 year guarantee
- Constant light output thanks to amalgam technology

Best Environmental choice

- The Ambiance Reflector range is fully RoHS compliant conforming to the most strict environmental legislation in the world

Ambiance Reflector PAR38

Wide beam

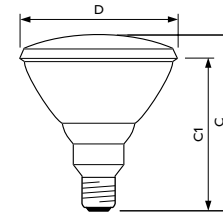

Ambiance Reflector PAR38

Dimensions in mm	C	F	D
PAR38 18W	135	43	120
PAR38 23W	159	73	120

Applications

- Wide range of indoor and outdoor applications like shops, windows displays, homes, hotels, buildings, statues, exhibitions, parks & gardens
- Not suitable for enclosed fixtures
- Not suitable for dimmers, electronic switches or remote controls

Preferred selection

Product ID	Lamp Wattage	Cap/ Base	Lamp Voltage	Frequency	Colour Temperature	Colour Rendering Index (R _a)	Light Output (Lumen)	Efficacy (Lm/W)	Order Code
	(W)		(V)	(Hz)	(K)				8710163
Cool Daylight									
Ambiance Reflector PAR38	23W	E27	220-240V	50-60Hz	6500	80	1000	50	40259210
Ambiance Reflector PAR38	23W	B22	220-240V	50-60Hz	6500	80	1000	50	40221510
Warm White									
Ambiance Reflector PAR38	23W	E27	220-240V	50-60Hz	2700	82	1250	54	40218510
Ambiance Reflector PAR38	23W	B22	220-240V	50-60Hz	2700	82	1250	54	40220810

Ambiance Candle Shape

Comfort



Ambiance Candle



For pleasant light effects

Attractive modern design in a Candle shape

- The Ambiance range offers a high decorative appeal to complement elegant, modern light fittings in homes, restaurants and hotels
- The elegant covered energy saver creates a comfortable low glare light that is soft on the eyes
- Available in a familiar Candle shape, similar in size to their incandescent equivalent

Up to 80% energy saving

- An ideal replacement for incandescent candles of 25W and 40W, saving up to 80% on energy consumption

Long Life: 6 years

- A long and reliable life of 6000 hrs, which is up to 6 times longer when compared to incandescent lamps
- 1 year guarantee, safety fuse and flicker free start

Best Environmental choice

- The Ambiance Candle range is fully RoHS compliant conforming to the most strict environmental legislation in the world

Ambiance Candle Shape

Comfort

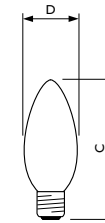

Ambiance Candle

Dimensions in mm	C	F
Ambiance Candle 5W	117	39
Ambiance Candle 8W	117	39

Applications

- Designed for replacement of incandescent lamps in standard shape in decorative and functional indoor applications
- Enclosed fixtures are required for outdoor applications
- Not suitable for dimming and electronic devices

Preferred selection

Product ID	Lamp Wattage (W)	Cap/ Base	Lamp Voltage (V)	Frequency (Hz)	Colour Temp. (K)	Colour Rendering Index	Light Output (Lumen)	Efficacy (Lm/W)	Dimmable	Order Code
Cool Daylight										
Ambiance Candle	5W	E14	220-240V	50-60Hz	6500	80	180	36	No	40184315
Ambiance Candle	5W	E27	220-240V	50-60Hz	6500	80	180	36	No	40175115
Ambiance Candle	5W	B22	220-240V	50-60Hz	6500	80	180	36	No	40177515
Ambiance Candle	8W	E14	220-240V	50-60Hz	6500	80	350	44	No	40185015
Ambiance Candle	8W	E27	220-240V	50-60Hz	6500	80	350	44	No	40181215
Ambiance Candle	8W	B22	220-240V	50-60Hz	6500	80	350	44	No	40183615

Warm White

Ambiance Candle	5W	E14	220-240V	50-60Hz	2700	82	190	38	No	40178215
Ambiance Candle	5W	E27	220-240V	50-60Hz	2700	82	190	38	No	40174415
Ambiance Candle	5W	B22	220-240V	50-60Hz	2700	82	190	38	No	40176815
Ambiance Candle	8W	E14	220-240V	50-60Hz	2700	82	370	46	No	40179915
Ambiance Candle	8W	E27	220-240V	50-60Hz	2700	82	370	46	No	40180515
Ambiance Candle	8W	B22	220-240V	50-60Hz	2700	82	370	46	No	40182915



Decotwist Decorative



Decorative energy saver for optimal brightness

Stylish modern design for direct installation

- Decotwist is a circular-shaped retrofit energy saving lamp with an integrated ballast and T5C burner and standard fitting, which allows for direct easy installation
- Available in two executions: with or without decorative covers

Brighter light, reliable life

- Round shape for excellent light dispersion and very bright light
- Almost constant light output (>80%) over recommended temperature range resulting in a reliable life
- Decotwist is available in both warm white and cool daylight colour temperatures
- All types offer a high intensity value of light with an

Save up to 80% energy

- 6000 hrs. Up to 6 times longer life when compared to normal incandescent lamps

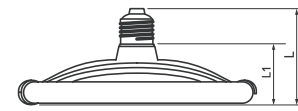

Decotwist

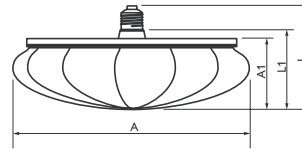
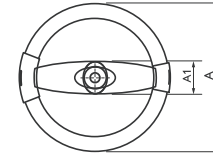

Decotwist with cover

Dimensions in mm	L	LI	A	AI	Burner
Decotwist	76	46.5	227.2	40.5	17
Decotwist with cover	124	96.0	290	84.0	17

Applications

- Decotwist range is designed for incandescent lamp replacement for general lighting in consumer and (semi-) professional applications
- Well suited to all shallow lampshades and pendant lamps fittings
- Not suitable for dimmers, electronic switches or remote controls

Preferred selection

Product ID	Lamp Wattage (W)	Cap/ Base (V)	Lamp Voltage (V)	Frequency (Hz)	Colour Temperature (K)	Luminous Flux (Lm)	Luminous Efficacy (Lm/W) (R _a)	Colour Rendering Index	Burner Type	Box quantity	Order code
Decotwist De Luxe - Cool Daylight											
Decotwist	25W	E27	220-240V	50-60Hz	6500	1100	44	80	T5C	6	31558845
Decotwist	25W	B22	220-240V	50-60Hz	6500	1100	44	80	T5C	6	31559545
Decotwist Blossom	25W	E27	220-240V	50-60Hz	6500	1100	44	80	T5C	6	31578610
Decotwist Blossom	25W	B22	220-240V	50-60Hz	6500	1100	44	80	T5C	6	31579310
Decotwist Lux	25W	E27	220-240V	50-60Hz	6500	1100	44	80	T5C	6	31574810
Decotwist Lux	25W	B22	220-240V	50-60Hz	6500	1100	44	80	T5C	6	31575510
Decotwist Ridge	25W	E27	220-240V	50-60Hz	6500	1100	44	80	T5C	6	31570010
Decotwist Ridge	25W	B22	220-240V	50-60Hz	6500	1100	44	80	T5C	6	31571710

Decotwist De Luxe - Warm White

Decotwist	25W	E27	220-240V	50-60Hz	2700	1150	46	82	T5C	6	31556445
Decotwist	25W	B22	220-240V	50-60Hz	2700	1150	46	82	T5C	6	31557145
Decotwist Blossom	25W	E27	220-240V	50-60Hz	2700	1150	46	82	T5C	6	31576210
Decotwist Blossom	25W	B22	220-240V	50-60Hz	2700	1150	46	82	T5C	6	31577910
Decotwist Lux	25W	E27	220-240V	50-60Hz	2700	1150	46	82	T5C	6	31572410
Decotwist Lux	25W	B22	220-240V	50-60Hz	2700	1150	46	82	T5C	6	31573110
Decotwist Ridge	25W	E27	220-240V	50-60Hz	2700	1150	46	82	T5C	6	31568710
Decotwist Ridge	25W	B22	220-240V	50-60Hz	2700	1150	46	82	T5C	6	31569410

MASTER ECOTONE High Lumen Twister

Value for money



High Lumen Twister



The bright new Twister for huge savings

High Lumen output for professional use

- The MASTER Ecotone High Twister is the perfect energy saving solution to replace conventional HPL and ML lamps offering brighter and better quality of light

Up to 70% energy saving

- The Twister range provides up to 70% energy savings when compared to ML 160W and 250W and for 20% energy savings and 70% better colour rendering when compared to HPL-N 80W and 125W

Long Life: 10 Years

- Long and reliable life of 10000 hrs, with a stable and constant light output

Best Environmental choice

- Fully RoHS compliant conforming to the most strict environmental legislation in the world

MASTER ECOTONE High Lumen Twister

Value for money

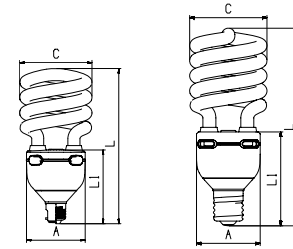

High Lumen Twister

Dimensions in mm	C	F
High Lumen Twister 45W	203	78
High Lumen Twister 65W	220	78
High Lumen Twister 80W	260	78

Applications

- Designed for professional applications in shops, industry and outdoor
- Enclosed fixtures
- Not suitable for dimmers, electronic switches or electronic devices/remote controls
- Safe in use, fully compliant to IEC and EMC Standards, HPF > 0.95

Preferred selection

Product ID	Lamp Wattage	Cap/ Base	Lamp Voltage	Colour Temp.	Luminous Flux	Luminous Efficacy	Colour Rendering Index	Equivalent light output to	Box quantity	Order Code
	(W)		(V)	(K)	(Lm)	(Lm/W)	(Ra)			8710163
Cool Daylight										
MASTER ECOTONE High Lumen Twister	45W	E27	220-240V	6500	2850	67	80	ML 160W-HPL-N 80W	6	21266110
MASTER ECOTONE High Lumen Twister	65W	E27	220-240V	6500	4000	65	80	ML 160W-250W-HPL-N 80W	6	21268510
MASTER ECOTONE High Lumen Twister	80W	E40	220-240V	6500	5300	66	80	ML 250W-HPL-N 125W	6	15963810
Cool White										
MASTER ECOTONE High Lumen Twister	45W	E27	220-240V	4000	3000	67	82	ML 160W-HPL-N 80W	6	21265410
MASTER ECOTONE High Lumen Twister	65W	E27	220-240V	4000	4000	65	82	ML 160W-250W-HPL-N 80W	6	21267810
MASTER ECOTONE High Lumen Twister	80W	E40	220-240V	4000	5600	70	82	ML 250W-HPL-N 125W	6	15962110

Compact Fluorescent Non-Integrated & Fluorescent Lamps



MASTER PL-S 2Pin

Reliable



PL-S 9W



Bright light in a compact size

Applications

- Designed for use in hotels, restaurants, theatres and homes
- Suitable for use in signs, corridors, security and orientation lighting

Why choose?

- Highest light output in its application, good colour rendering and energy savings
- Almost constant light output through entire life
- Long average life time reducing maintenance cost

Technical features

- Energy-saving compact fluorescent lamps
- Compact long-arc low-pressure mercury discharge lamp
- Envelope consists of 2 parallel narrow fluorescent tubes

MASTER PL-S 2Pin

Reliable

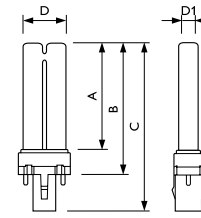

PL-S

Dimensions in mm	A	B	C	D	D1
	max.	min.	max.	max.	max.
PL-S 5W/2P	67	83	105	28	13
PL-S 7W/2P	97	113	135	28	13
PL-S 9W/2P	129	145	167	28	13
PL-S 11W/2P	198	214	236	28	13

Preferred selection

Product ID	Packaging Configuration	Net weight per piece (g)	Cap/ Base	Colour Designation	Colour Temperature (K)	Colour Rendering Index (Ra)
MASTER PL-S 5W/827/2P ICT	5X10BOX	30	G23	Incandescent White	2700	82
MASTER PL-S 5W/840/2P ICT	5X10BOX	30	G23	Cool White	4000	82
MASTER PL-S 7W/827/2P ICT	5X10BOX	35	G23	Incandescent White	2700	82
MASTER PL-S 7W/830/2P ICT	5X10BOX	35	G23	Warm White	3000	82
MASTER PL-S 7W/840/2P ICT	5X10BOX	35	G23	Cool White	4000	82
MASTER PL-S 9W/827/2P ICT	5X10BOX	41	G23	Incandescent White	2700	82
MASTER PL-S 9W/830/2P ICT	5X10BOX	41	G23	Warm White	3000	82
MASTER PL-S 9W/840/2P ICT	5X10BOX	41	G23	Cool White	4000	82
MASTER PL-S 11W/827/2P ICT	5X10BOX	58	G23	Incandescent White	2700	82
MASTER PL-S 11W/830/2P ICT	5X10BOX	58	G23	Warm White	3000	82
MASTER PL-S 11W/840/2P ICT	5X10BOX	58	G23	Cool White	4000	82

Product ID	Lamp Voltage (V)	Lamp Current EM (A)	Lamp Wattage EM (W)	Luminous Flux Lamp EM (lm)	Luminous Efficacy Lamp EM (lm/W)	Energy Efficiency Label	Dimmable	Order Code
MASTER PL-S 5W/827/2P ICT	35	0.180	5.4	250	46	B	No	26045170
MASTER PL-S 5W/840/2P ICT	35	0.180	5.4	250	46	B	No	26048270
MASTER PL-S 7W/827/2P ICT	47	0.175	7.1	400	56	B	No	26057470
MASTER PL-S 7W/830/2P ICT	47	0.175	7.1	400	56	B	No	26062870
MASTER PL-S 7W/840/2P ICT	47	0.175	7.1	400	56	B	No	26065970
MASTER PL-S 9W/827/2P ICT	60	0.170	8.7	600	69	B	No	26079670
MASTER PL-S 9W/830/2P ICT	60	0.170	8.7	600	69	B	No	26084070
MASTER PL-S 9W/840/2P ICT	60	0.170	8.7	600	69	B	No	26087170
MASTER PL-S 11W/827/2P ICT	91	0.155	11.8	900	76	B	No	26101470
MASTER PL-S 11W/830/2P ICT	91	0.155	11.8	900	76	B	No	26106970
MASTER PL-S 11W/840/2P ICT	91	0.155	11.8	900	76	B	No	26109070

MASTER PL-S 4Pin

Reliable



PL-S 9W



Bright light in a compact size

Applications

- Designed for use in hotels, restaurants, theatres and homes
- For use in signs, corridors, security and orientation lighting

Why choose?

- Highest light output in its application and good colour rendering and energy efficiency
- Almost constant light output through entire life
- Long average life time reducing maintenance cost

Technical features

- Energy-saving compact fluorescent lamps
- Compact long-arc low-pressure mercury discharge lamp
- Envelope consists of 2 parallel narrow fluorescent tubes

MASTER PL-S 4Pin

Reliable

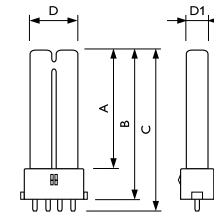

PL-S 4Pin

Dimensions in mm	A	B	C	D	D1
	max.	min.	max.	max.	max.
PL-S 5W/4P	66	83	89.1	28	13
PL-S 7W/4P	96	113	119.1	28	13
PL-S 9W/4P	128	145	151.1	28	13
PL-S 11W/4P	196	214	219.9	28	13

Preferred selection

Product ID	Packaging Configuration	Net weight per piece (g)	Cap/ Base	Colour Designation	Colour Temperature (K)	Colour Rendering Index (Ra)
MASTER PL-S 5W/827/4P ICT	5X10BOX	27	2G7	Incandescent White	2700	82
MASTER PL-S 5W/840/4P ICT	5X10BOX	27	2G7	Cool White	4000	82
MASTER PL-S 7W/827/4P ICT	5X10BOX	32	2G7	Incandescent White	2700	82
MASTER PL-S 7W/830/4P ICT	5X10BOX	32	2G7	Warm White	3000	82
MASTER PL-S 7W/840/4P ICT	5X10BOX	32	2G7	Cool White	4000	82
MASTER PL-S 9W/827/4P ICT	5X10BOX	38	2G7	Incandescent White	2700	82
MASTER PL-S 9W/830/4P ICT	5X10BOX	38	2G7	Warm White	3000	82
MASTER PL-S 9W/840/4P ICT	5X10BOX	38	2G7	Cool White	4000	82
MASTER PL-S 11W/827/4P ICT	5X10BOX	55	2G7	Incandescent White	2700	82
MASTER PL-S 11W/830/4P ICT	5X10BOX	55	2G7	Warm White	3000	82
MASTER PL-S 11W/840/4P ICT	5X10BOX	55	2G7	Cool White	4000	82

Product ID	Lamp Voltage (V)	Lamp Current (A)	Lamp Wattage (W)	Luminous Flux Lamp (lm)	Luminous Efficacy Lamp (lm/W)	Energy Efficiency	Dimmable	Order Code
MASTER PL-S 5W/827/4P ICT	27	0.19	5	250	50	B	Yes	8711500
MASTER PL-S 5W/840/4P ICT	27	0.19	5	250	50	B	Yes	26051270
MASTER PL-S 7W/827/4P ICT	37	0.175	6.5	400	61	B	Yes	26070370
MASTER PL-S 7W/830/4P ICT	37	0.175	6.5	400	61	B	Yes	26073470
MASTER PL-S 7W/840/4P ICT	37	0.175	6.5	400	61	B	Yes	26076570
MASTER PL-S 9W/827/4P ICT	48	0.17	8	600	75	B	Yes	26090170
MASTER PL-S 9W/830/4P ICT	48	0.17	8	600	75	B	Yes	26093270
MASTER PL-S 9W/840/4P ICT	48	0.17	8	600	75	B	Yes	26096370
MASTER PL-S 11W/827/4P ICT	75	0.15	11	900	82	B	Yes	26114470
MASTER PL-S 11W/830/4P ICT	75	0.15	11	900	82	B	Yes	26119970
MASTER PL-S 11W/840/4P ICT	75	0.15	11	900	82	B	Yes	26122970

MASTER PL-C 2Pin

Reliable



PL-C 10W



Bright light in a compact size

Applications

- Designed for general or supplementary lighting in professional or home environments
- Recessed or surface-mounted downlighters, wall units, table lamps and pendant lamps

Why choose?

- Highest light output in its application and good colour rendering and energy efficiency
- Almost constant light output through entire life
- Long average life time reducing maintenance costs

Technical features

- Energy-saving compact fluorescent lamps
- Compact long-arc low-pressure mercury discharge lamp
- Envelope consists of 4 parallel narrow fluorescent tubes

MASTER PL-C 2Pin

Reliable

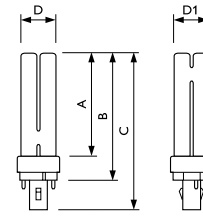

MASTER PL-C 2Pin

Dimensions in mm	A	B	C	D	D1
	max.	min.	max.	max.	max.
PL-C 10W/2P	75.7	94	116.4	27.1	27.1
PL-C 13W/2P	97.7	116	138.4	27.1	27.1
PL-C 18W/2P	109.7	128	150.4	27.1	27.1
PL-C 26W/2P	130.7	149	171.4	27.1	27.1

Preferred selection

Product ID	Packaging Configuration	Net weight per piece (g)	Cap/Base	Colour Designation	Colour Temperature (K)	Colour Rendering Index (Ra)
MASTER PL-C 10W/827/2P 1CT	5X10BOX	45	G24d-1	Incandescent White	2700	82
MASTER PL-C 10W/830/2P 1CT	5X10BOX	45	G24d-1	Warm White	3000	82
MASTER PL-C 10W/840/2P 1CT	5X10BOX	45	G24d-1	Cool White	4000	82
MASTER PL-C 13W/827/2P 1CT	5X10BOX	53.6	G24d-1	Incandescent White	2700	82
MASTER PL-C 13W/830/2P 1CT	5X10BOX	53.6	G24d-1	Warm White	3000	82
MASTER PL-C 13W/840/2P 1CT	5X10BOX	53.6	G24d-1	Cool White	4000	82
MASTER PL-C 13W/865/2P 1CT	5X10BOX	53.6	G24d-1	Cool Daylight	6500	80
MASTER PL-C 18W/827/2P 1CT	5X10BOX	57.8	G24d-2	Incandescent White	2700	82
MASTER PL-C 18W/830/2P 1CT	5X10BOX	57.8	G24d-2	Warm White	3000	82
MASTER PL-C 18W/835/2P 1CT	5X10BOX	57.8	G24d-2	White	3500	82
MASTER PL-C 18W/840/2P 1CT	5X10BOX	57.8	G24d-2	Cool White	4000	82
MASTER PL-C 18W/865/2P 1CT	5X10BOX	57.8	G24d-2	Cool Daylight	6500	80
MASTER PL-C 26W/827/2P 1CT	5X10BOX	64.3	G24d-3	Incandescent White	2700	82
MASTER PL-C 26W/830/2P 1CT	5X10BOX	64.3	G24d-3	Warm White	3000	82
MASTER PL-C 26W/835/2P 1CT	5X10BOX	64.3	G24d-3	White	3500	82
MASTER PL-C 26W/840/2P 1CT	5X10BOX	64.3	G24d-3	Cool White	4000	82
MASTER PL-C 26W/865/2P 1CT	5X10BOX	64.3	G24d-3	Cool Daylight	6500	80

MASTER PL-C 2Pin

Reliable

Product ID	Lamp Voltage (V)	Lamp Current EM (A)	Lamp Wattage EM (W)	Luminous Flux Lamp EM (lm)
MASTER PL-C 10W/827/2P CT	64	0.19	10	600
MASTER PL-C 10W/830/2P CT	64	0.19	10	600
MASTER PL-C 10W/840/2P CT	64	0.19	10	600
MASTER PL-C 13W/827/2P CT	91	0.175	13	900
MASTER PL-C 13W/830/2P CT	91	0.175	13	900
MASTER PL-C 13W/840/2P CT	91	0.175	13	900
MASTER PL-C 13W/865/2P CT	91	0.175	13	900
MASTER PL-C 18W/827/2P CT	100	0.22	18	1200
MASTER PL-C 18W/830/2P CT	100	0.22	18	1200
MASTER PL-C 18W/835/2P CT	100	0.22	18	1200
MASTER PL-C 18W/840/2P CT	100	0.22	18	1200
MASTER PL-C 18W/865/2P CT	100	0.22	18	1200
MASTER PL-C 26W/827/2P CT	105	0.325	26	1800
MASTER PL-C 26W/830/2P CT	105	0.325	26	1800
MASTER PL-C 26W/835/2P CT	105	0.325	26	1800
MASTER PL-C 26W/840/2P CT	105	0.325	26	1800
MASTER PL-C 26W/865/2P CT	105	0.325	26	1800

Product ID	Luminous Efficacy Lamp EM (lm/W)	Energy Efficiency Label	Dimmable	Order Code
MASTER PL-C 10W/827/2P CT	60	B	No	8711500 70681270
MASTER PL-C 10W/830/2P CT	60	B	No	70724670
MASTER PL-C 10W/840/2P CT	60	B	No	70498670
MASTER PL-C 13W/827/2P CT	69	A	No	62081170
MASTER PL-C 13W/830/2P CT	69	A	No	62084270
MASTER PL-C 13W/840/2P CT	69	A	No	62086670
MASTER PL-C 13W/865/2P CT	69	A	No	63523570
MASTER PL-C 18W/827/2P CT	67	B	No	62088070
MASTER PL-C 18W/830/2P CT	67	B	No	62091070
MASTER PL-C 18W/835/2P CT	67	B	No	86646270
MASTER PL-C 18W/840/2P CT	67	B	No	62093470
MASTER PL-C 18W/865/2P CT	67	B	No	63527370
MASTER PL-C 26W/827/2P CT	69	B	No	62095870
MASTER PL-C 26W/830/2P CT	69	B	No	62098970
MASTER PL-C 26W/835/2P CT	69	B	No	86650970
MASTER PL-C 26W/840/2P CT	69	B	No	62100970
MASTER PL-C 26W/865/2P CT	69	B	No	63531070

MASTER PL-C 2Pin

Reliable



MASTER PL-C 4Pin

Reliable



PL-C 10W



Bright light in a compact size

Applications

- Designed for general or supplementary lighting in professional or home environments
- Recessed or surface-mounted downlighters, wall units, table lamps and pendant lamps

Why choose?

- Highest light output in its application and good colour rendering and energy efficiency
- Almost constant light output through entire life
- Long average life time reducing maintenance costs

Technical features

- Energy-saving compact fluorescent lamps
- Compact long-arc low-pressure mercury discharge lamp
- Envelope consists of 4 parallel narrow fluorescent tubes

MASTER PL-C 4Pin

Reliable

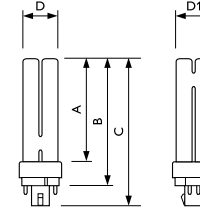

PL-C 4Pin

Dimensions in mm	A	B	C	D	D1
	max.	min.	max.	max.	max.
PL-S 10W/4P	75.7	94	108.9	27.1	27.1
PL-S 13W/4P	97.7	116	130.9	27.1	27.1
PL-S 18W/4P	109.7	128	142.9	27.1	27.1
PL-S 26W/4P	130.7	149	163.9	27.1	27.1

Preferred selection

Product ID	Packaging Configuration	Net weight per piece (g)	Cap/ Base	Colour Designation	Colour Temperature	Colour Rendering Index (Ra)
					(K)	(Ra)
MASTER PL-C 10W/827/4P ICT	5X10BOX	41.4	G24q-1	Incandescent White	2700	82
MASTER PL-C 10W/830/4P ICT	5X10BOX	41.4	G24q-1	Warm White	3000	82
MASTER PL-C 10W/840/4P ICT	5X10BOX	41.4	G24q-1	Cool White	4000	82
MASTER PL-C 13W/827/4P ICT	5X10BOX	49.9	G24q-1	Incandescent White	2700	82
MASTER PL-C 13W/830/4P ICT	5X10BOX	49.9	G24q-1	Warm White	3000	82
MASTER PL-C 13W/840/4P ICT	5X10BOX	49.9	G24q-1	Cool White	4000	82
MASTER PL-C 18W/827/4P ICT	5X10BOX	55.3	G24q-2	Incandescent White	2700	82
MASTER PL-C 18W/830/4P ICT	5X10BOX	55.3	G24q-2	Warm White	3000	82
MASTER PL-C 18W/840/4P ICT	5X10BOX	55.3	G24q-2	Cool White	4000	82
MASTER PL-C 26W/827/4P ICT	5X10BOX	60.4	G24q-3	Incandescent White	2700	82
MASTER PL-C 26W/830/4P ICT	5X10BOX	60.4	G24q-3	Warm White	3000	82
MASTER PL-C 26W/835/4P ICT	5X10BOX	60.4	G24q-3	White	3500	82
MASTER PL-C 26W/840/4P ICT	5X10BOX	60.4	G24q-3	Cool White	4000	82
MASTER PL-C 26W/865/4P ICT	5X10BOX	60.4	G24q-3	Cool Daylight	6500	80

Product ID	Lamp Voltage	Lamp Current	Lamp Wattage	Luminous Flux Lamp	Luminous Efficacy Lamp	Energy Efficiency	Dimmable	Order Code
	(V)	(A)	(W)	(lm)	(lm/W)	Label		
MASTER PL-C 10W/827/4P ICT	51	0.19	9.5	600	63	B	Yes	8711500 62325670
MASTER PL-C 10W/830/4P ICT	51	0.19	9.5	600	63	B	Yes	62329470
MASTER PL-C 10W/840/4P ICT	51	0.19	9.5	600	63	B	Yes	62330070
MASTER PL-C 13W/827/4P ICT	77	0.165	12.5	900	72	A	Yes	62326370
MASTER PL-C 13W/830/4P ICT	77	0.165	12.5	900	72	A	Yes	62331770
MASTER PL-C 13W/840/4P ICT	77	0.165	12.5	900	72	A	Yes	62332470
MASTER PL-C 18W/827/4P ICT	80	0.21	16.5	1200	73	B	Yes	62327070
MASTER PL-C 18W/830/4P ICT	80	0.21	16.5	1200	73	B	Yes	62333170
MASTER PL-C 18W/840/4P ICT	80	0.21	16.5	1200	73	B	Yes	62334870
MASTER PL-C 26W/827/4P ICT	80	0.3	24	1800	75	B	Yes	62328770
MASTER PL-C 26W/830/4P ICT	80	0.3	24	1800	75	B	Yes	62335570
MASTER PL-C 26W/835/4P ICT	80	0.3	24	1800	75	B	Yes	86653070
MASTER PL-C 26W/840/4P ICT	80	0.3	24	1800	75	B	Yes	62336270
MASTER PL-C 26W/865/4P ICT	80	0.3	24	1800	75	B	Yes	64457270

MASTER PL-L 4Pin

Compact



PL-L 24W



Always optimal light performance

Applications

- Designed for general lighting in shops, offices, hotels and specific task lighting, as well as outdoors in residential areas and parks

Why choose?

- Optimal light performance for short or long operation
- Long life and sustainable light output

Technical features

- Energy-saving compact fluorescent lamps
- Compact long-arc low-pressure mercury discharge lamp
- Envelope consists of 2 parallel fluorescent tubes

MASTER PL-L 4Pin

Compact

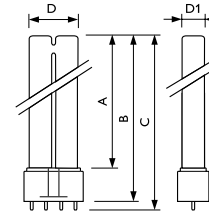

MASTER PL-L 4Pin

Dimensions in mm	A	B	C	D	D1
	max.	min.	max.	max.	max.
PL-L 18/4P	195	220	227	38	18
PL-L 24/4P	290	315	322	38	18
PL-L 36/4P	385	410	417	38	18
PL-L 40/4P	510	535	542	38	18
PL-L 55/4P	510	535	542	38	18
PL-L 80/4P	540	565	572	38	18

Preferred selection

Product ID	Packaging Configuration	Net weight per piece (g)	Cap/ Base	Colour Designation	Colour Temperature (K)	Colour Rendering Index (Ra)
MASTER PL-L 18W/827/4P 1CT	25	60.9	2G11	Incandescent White	2700	82
MASTER PL-L 18W/830/4P 1CT	25	60.9	2G11	Warm White	3000	82
MASTER PL-L 18W/840/4P 1CT	25	60.9	2G11	Cool White	4000	82
MASTER PL-L 18W/865/4P 1CT	25	60.9	2G11	Cool Daylight	6500	80
MASTER PL-L 24W/827/4P 1CT	25	92	2G11	Incandescent White	2700	82
MASTER PL-L 24W/830/4P 1CT	25	92	2G11	Warm White	3000	82
MASTER PL-L 24W/840/4P 1CT	25	92	2G11	Cool White	4000	82
MASTER PL-L 24W/865/4P 1CT	25	92	2G11	Cool Daylight	6500	80
MASTER PL-L 36W/827/4P 1CT	25	104.2	2G11	Incandescent White	2700	82
MASTER PL-L 36W/830/4P 1CT	25	104.2	2G11	Warm White	3000	82
MASTER PL-L 36W/840/4P 1CT	25	104.2	2G11	Cool White	4000	82
MASTER PL-L 36W/865/4P 1CT	25	104.2	2G11	Cool Daylight	6500	80
MASTER PL-L 40W/830/4P 1CT	25	146	2G11	Warm White	3000	82
MASTER PL-L 40W/840/4P 1CT	25	146	2G11	Cool White	4000	82
MASTER PL-L 55W/827/4P 1CT	25	146	2G11	Incandescent White	2700	82
MASTER PL-L 55W/830/4P 1CT	25	146	2G11	Warm White	3000	82
MASTER PL-L 55W/840/4P 1CT	25	146	2G11	Cool White	4000	82
MASTER PL-L 55W/865/4P 1CT	25	146	2G11	Cool Daylight	6500	80
MASTER PL-L 80W/830/4P 1CT	25	152	2G11	Warm White	3000	82
MASTER PL-L 80W/840/4P 1CT	25	152	2G11	Cool White	4000	82

Product ID	Lamp Voltage Electronic (V)	Lamp Current Electronic (A)	Lamp Wattage Electronic (W)	Luminous Flux Lamp Electronic (lm)	Luminous Efficacy Lamp Electronic (lm/W)	Energy Efficiency Label	Dimmable	Order Code
MASTER PL-L 18W/827/4P 1CT	50	0.32	16	1200	75	B	Yes	8711500 70667640
MASTER PL-L 18W/830/4P 1CT	50	0.32	16	1200	75	B	Yes	70668340
MASTER PL-L 18W/840/4P 1CT	50	0.32	16	1200	75	B	Yes	70669040
MASTER PL-L 18W/865/4P 1CT	50	0.32	16	1200	75	B	Yes	63514340
MASTER PL-L 24W/827/4P 1CT	75	0.3	22	1800	82	B	Yes	70670640
MASTER PL-L 24W/830/4P 1CT	75	0.3	22	1800	82	B	Yes	70671340
MASTER PL-L 24W/840/4P 1CT	75	0.3	22	1800	82	B	Yes	70672040
MASTER PL-L 24W/865/4P 1CT	75	0.3	22	1800	82	B	Yes	63517440
MASTER PL-L 36W/827/4P 1CT	90	0.36	32	2900	90	A	Yes	70673740
MASTER PL-L 36W/830/4P 1CT	90	0.36	32	2900	90	A	Yes	70674440
MASTER PL-L 36W/840/4P 1CT	90	0.36	32	2900	90	A	Yes	70675140
MASTER PL-L 36W/865/4P 1CT	90	0.36	32	2900	90	A	Yes	63520440
MASTER PL-L 40W/830/4P 1CT	126	0.32	40	3500	87	A	Yes	61094240
MASTER PL-L 40W/840/4P 1CT	126	0.32	40	3500	87	A	Yes	61097340
MASTER PL-L 55W/827/4P 1CT	101	0.55	55	4800	87	A	Yes	64148940
MASTER PL-L 55W/830/4P 1CT	101	0.55	55	4800	87	A	Yes	61541140
MASTER PL-L 55W/840/4P 1CT	101	0.55	55	4800	87	A	Yes	61542840
MASTER PL-L 55W/865/4P 1CT	101	0.55	55	4500	82	A	Yes	26170040
MASTER PL-L 80W/830/4P 1CT	145	0.555	80	6000	75	B	Yes	86708740
MASTER PL-L 80W/840/4P 1CT	145	0.555	80	6000	75	B	Yes	86712440



MASTER TL5 High Efficiency

Design



TL5



Aesthetics and high quality lighting

Applications

- Ideally suited for recessed, surface mounted and suspended luminaires in applications like offices, shops, schools, public buildings and industry, where ever high-quality, energy-effective lighting is required

Why choose?

- Offers higher efficiencies and energy savings compared with TL-D lamps
- Virtually constant lumen level with excellent lumen maintenance
- Good colour rendering

Technical features

- 40% thinner than TL-D lamps
- High lamp efficacies up to 104 lm/W
- Highly efficient 3-band fluorescent coating in combination with precoating
- Specifically designed for operation with electronic gear and well suited for dimming

MASTER TL5 High Efficiency

Design

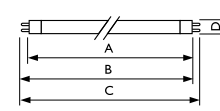

TL5

Dimensions in mm	A		B		C		D	
	max.	min.	max.	max.	max.	max.	max.	
TL5 14W	549	553.7	556.1	563.2	17			
TL5 21W	849	853.7	856.1	863.2	17			
TL5 28W	1149	1153.7	1156.1	1163.2	17			
TL5 35W	1449	1453.7	1456.1	1463.2	17			

Preferred selection

Product ID	Packaging Configuration	Net weight per piece (g)	Cap/ Base	Colour Designation	Colour Temperature (K)	Colour Rendering Index (Ra)
MASTER TL5 HE Super 80 14W/827 SLV	40	54	G5	Incandescent White	2700	85
MASTER TL5 HE Super 80 14W/830 SLV	40	54	G5	Warm White	3000	85
MASTER TL5 HE Super 80 14W/840 SLV	40	54	G5	Cool White	4000	85
MASTER TL5 HE Super 80 14W/850 SLV	40	54	G5	Daylight	5000	85
MASTER TL5 HE Super 80 14W/865 SLV	40	54	G5	Cool Daylight	6500	85
MASTER TL5 HE Super 80 21W/827 SLV	40	78	G5	Incandescent White	2700	85
MASTER TL5 HE Super 80 21W/830 SLV	40	78	G5	Warm White	3000	85
MASTER TL5 HE Super 80 21W/840 SLV	40	78	G5	Cool White	4000	85
MASTER TL5 HE Super 80 21W/865 SLV	40	78	G5	Cool Daylight	6500	85
MASTER TL5 HE Super 80 28W/827 SLV	40	105	G5	Incandescent White	2700	85
MASTER TL5 HE Super 80 28W/830 SLV	40	105	G5	Warm White	3000	85
MASTER TL5 HE Super 80 28W/840 SLV	40	105	G5	Cool White	4000	85
MASTER TL5 HE Super 80 28W/850 SLV	40	105	G5	Daylight	5000	85
MASTER TL5 HE Super 80 28W/865 SLV	40	105	G5	Cool Daylight	6500	85
MASTER TL5 HE Super 80 35W/827 SLV	40	132	G5	Incandescent White	2700	85
MASTER TL5 HE Super 80 35W/830 SLV	40	132	G5	Warm White	3000	85
MASTER TL5 HE Super 80 35W/840 SLV	40	132	G5	Cool White	4000	85
MASTER TL5 HE Super 80 35W/865 SLV	40	132	G5	Cool Daylight	6500	85

Product ID	Lamp	Lamp	Luminous	Luminous	Luminance	Energy	Order Code
	Voltage	Current	Flux Lamp	Efficacy Lamp, Electronic	Average	Efficiency	
	Electronic 25°C (V)	Electronic 25°C (A)	Electronic 25°C (lm)	at top 35°C (lm/W)	Electronic 25°C (cd/cm ²)	Label	
MASTER TL5 HE Super 80 14W/827 SLV	83	0.17	1200	96	1.5	A	64102155
MASTER TL5 HE Super 80 14W/830 SLV	83	0.17	1200	96	1.5	A	63938755
MASTER TL5 HE Super 80 14W/840 SLV	83	0.17	1200	96	1.5	A	63940055
MASTER TL5 HE Super 80 14W/850 SLV	83	0.17	1100	89	1.4	A	26127455
MASTER TL5 HE Super 80 14W/865 SLV	83	0.17	1100	89	1.4	A	71009355
MASTER TL5 HE Super 80 21W/827 SLV	125	0.17	1900	100	1.5	A	64320955
MASTER TL5 HE Super 80 21W/830 SLV	125	0.17	1900	100	1.5	A	63942455
MASTER TL5 HE Super 80 21W/840 SLV	125	0.17	1900	100	1.5	A	63944855
MASTER TL5 HE Super 80 21W/865 SLV	125	0.17	1750	93	1.4	A	71011655
MASTER TL5 HE Super 80 28W/827 SLV	166	0.17	2600	104	1.5	A	643223 55
MASTER TL5 HE Super 80 28W/830 SLV	166	0.17	2600	104	1.5	A	639462 55
MASTER TL5 HE Super 80 28W/840 SLV	166	0.17	2600	104	1.5	A	639486 55
MASTER TL5 HE Super 80 28W/850 SLV	166	0.17	2400	96	1.4	A	260208 55
MASTER TL5 HE Super 80 28W/865 SLV	166	0.17	2400	96	1.4	A	710154 55
MASTER TL5 HE Super 80 35W/827 SLV	208	0.17	3300	104	1.5	A	643247 55
MASTER TL5 HE Super 80 35W/830 SLV	208	0.17	3300	104	1.5	A	639509 55
MASTER TL5 HE Super 80 35W/840 SLV	208	0.17	3300	104	1.5	A	639523 55
MASTER TL5 HE Super 80 35W/865 SLV	208	0.17	3100	97	1.4	A	710185 55

SLV: Sleeve packaging

Note: Nominal luminous flux, average luminance and electrical specifications defined at an ambient temperature of 25°C in free burning position on reference ballast/Luminous efficacy (lm/W) defined at top of the lumen curve (approx. 35°C).



MASTER TL5 High Output

Design



TL5



High light output

Applications

- Offers economic solutions with high-ceiling lighting in shops, industry and department stores
- The high luminous flux gives optimal results in aesthetic pendants and furniture-mounted luminaires in offices, workshops, restaurants and reception areas

Why choose?

- Optimised for installations which need high luminous flux
- Virtually constant lumen level with excellent lumen maintenance
- Good colour rendering

Technical features

- 40% thinner than TL-D lamps
- Designed for high lumen output and system miniaturization
- Highly efficient 3-band fluorescent coating in combination with precoating
- Specifically designed for operation with electronic gear and well-suited for dimming
- Can be ignited from -15°C to + 50°C

MASTER TL5 High Output

Design

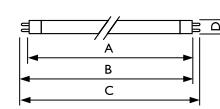

TL5

Dimensions in mm	A		B		C		D	
	max.	min.	max.	max.	max.	max.	max.	max.
TL5 24W	549	554	556	563	17			
TL5 39W	849	854	856	863	17			
TL5 54W	1149	1154	1156	1163	17			
TL5 49W/80W	1449	1454	1456	1463	17			

Preferred selection

Product ID	Packaging Configuration	Net weight per piece (g)	Cap/ Base	Colour Designation	Colour Temperature (K)	Colour Rendering Index (Ra)
MASTER TL5 HO Super 80 24W/827 SLV	40	54	G5	Incandescent White	2700	85
MASTER TL5 HO Super 80 24W/830 SLV	40	54	G5	Warm White	3000	85
MASTER TL5 HO Super 80 24W/840 SLV	40	54	G5	Cool White	4000	85
MASTER TL5 HO Super 80 24W/865 SLV	40	54	G5	Cool Daylight	6500	85
MASTER TL5 HO Super 80 39W/827 SLV	40	78	G5	Incandescent White	2700	85
MASTER TL5 HO Super 80 39W/830 SLV	40	78	G5	Warm White	3000	85
MASTER TL5 HO Super 80 39W/840 SLV	40	78	G5	Cool White	4000	85
MASTER TL5 HO Super 80 39W/865 SLV	40	78	G5	Cool Daylight	6500	85
MASTER TL5 HO Super 80 49W/827 SLV	40	132	G5	Incandescent White	2700	85
MASTER TL5 HO Super 80 49W/830 SLV	40	132	G5	Warm White	3000	85
MASTER TL5 HO Super 80 49W/840 SLV	40	132	G5	Cool White	4000	85
MASTER TL5 HO Super 80 49W/865 SLV	40	132	G5	Cool Daylight	6500	85
MASTER TL5 HO Super 80 54W/827 SLV	40	105	G5	Incandescent White	2700	85
MASTER TL5 HO Super 80 54W/830 SLV	40	105	G5	Warm White	3000	85
MASTER TL5 HO Super 80 54W/840 SLV	40	105	G5	Cool White	4000	85
MASTER TL5 HO Super 80 54W/865 SLV	40	105	G5	Cool Daylight	6500	85
MASTER TL5 HO Super 80 80W/830 SLV	40	132	G5	Warm White	3000	85
MASTER TL5 HO Super 80 80W/840 SLV	40	132	G5	Cool White	4000	85
MASTER TL5 HO Super 80 80W/865 SLV	40	132	G5	Cool Daylight	6500	85

SLV: Sleeve packaging

Note: Nominal luminous flux, average luminance and electrical specifications defined at an ambient temperature of 25°C in free burning position on reference ballast/Luminous efficacy (lm/W) defined at top of the lumen curve (approx. 35°C).

Product ID	Lamp Voltage Electronic 25°C (V)	Lamp Current Electronic 25°C (A)	Luminous Flux Lamp Electronic 25°C (lm)	Luminous Efficacy Lamp, Electronic at top 35°C (lm/W)	Luminance Average Electronic 25°C (cd/cm ²)	Energy Efficiency Label	Order Code
MASTER TL5 HO Super 80 24W/827 SLV	80	0	1750	89	2	B	64308755
MASTER TL5 HO Super 80 24W/830 SLV	80	0	1750	89	2	B	63958555
MASTER TL5 HO Super 80 24W/840 SLV	80	0	1750	89	2	B	63960855
MASTER TL5 HO Super 80 24W/865 SLV	80	0	1650	84	2	B	64393355
MASTER TL5 HO Super 80 39W/827 SLV	119	0	3100	92	3	B	64310055
MASTER TL5 HO Super 80 39W/830 SLV	119	0	3100	92	3	B	63962255
MASTER TL5 HO Super 80 39W/840 SLV	119	0	3100	92	3	B	63964655
MASTER TL5 HO Super 80 39W/865 SLV	119	0	2950	87	2	B	64387255
MASTER TL5 HO Super 80 49W/827 SLV	195	0	4300	99	2	B	64312455
MASTER TL5 HO Super 80 49W/830 SLV	195	0	4300	99	2	B	63954755
MASTER TL5 HO Super 80 49W/840 SLV	195	0	4300	99	2	B	63956155
MASTER TL5 HO Super 80 49W/865 SLV	195	0	4100	94	2	B	64389655
MASTER TL5 HO Super 80 54W/827 SLV	118	0	4450	93	3	B	64314855
MASTER TL5 HO Super 80 54W/830 SLV	118	0	4450	93	3	B	64316255
MASTER TL5 HO Super 80 54W/840 SLV	118	0	4450	93	3	B	64318655
MASTER TL5 HO Super 80 54W/865 SLV	118	0	4250	89	3	B	64391955
MASTER TL5 HO Super 80 80W/830 SLV	151	1	6150	88	3	B	71040655
MASTER TL5 HO Super 80 80W/840 SLV	130	1	6150	88	3	B	71045155
MASTER TL5 HO Super 80 80W/865 SLV	151	1	5850	83	3	B	71047555

SLV: Sleeve packaging

Note: Nominal luminous flux, average luminance and electrical specifications defined at an ambient temperature of 25°C in free burning position on reference ballast/Luminous efficacy (lm/W) defined at top of the lumen curve (approx. 35°C).



MASTER TL-D Super 80

Natural



MASTER TL-D Super 80



Experience true colours

Applications

- Schools, offices, shops, industrial plants, homes

Why choose?

- Up to 40% longer life than standard fluorescent lamps with an almost constant light output over life, significantly reducing maintenance costs
- Provides up to 30% more light compared to standard fluorescent lamps, allowing you to generate the same amount of light with fewer lamps
- Good colour rendering. Provides a pleasant working environment and enables increased productivity

Technical features

- Good colour rendering: Ra>80
- Lowest mercury content on the market: 2mg
- Triphosphor for good colour rendering

Lifetime

- 18000 hrs on conventional gear (avg life 50% survivors on EM gear, 12hrs switching cycle)
- 23000 hrs on electronic gear (avg life 50% survivors on EL gear, 12hrs switching cycle)

MASTER TL-D Super 80

Natural

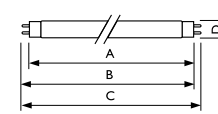

MASTER TL-D Super 80

Dimensions in mm	A	B	C	D
	max.	max.	max.	max.
TL-D 18W	589.8	596.9	604	28
TL-D 36W	1199.4	1206.5	1213	28
TL-D 58W	1500	1507	1514	28

Preferred selection

Product ID	Luminous Flux Lamp (lm)	Luminance Average EM (cd/cm sq)	Colour Rendering Index (Ra)	Colour Designation	Order Code
MASTER TL-D Super 80 18W/827 SLV	1350	1.00	85	Incandescent White	63162640
MASTER TL-D Super 80 18W/830 SLV	1350	1.00	85	Warm White	63165740
MASTER TL-D Super 80 18W/840 SLV	1350	1.00	85	Cool White	63171840
MASTER TL-D Super 80 18W/865 SLV	1300	0.95	85	Cool Daylight	63177040
MASTER TL-D Super 80 36W/827 SLV	3350	1.25	85	Incandescent White	63192340
MASTER TL-D Super 80 36W/830 SLV	3350	1.25	85	Warm White	63195440
MASTER TL-D Super 80 36W/840 SLV	3350	1.25	85	Cool White	63201240
MASTER TL-D Super 80 36W/865 SLV	3250	1.20	85	Cool Daylight	63207440
MASTER TL-D Super 80 58W/827 SLV	5200	1.50	85	Incandescent White	63210440
MASTER TL-D Super 80 58W/830 SLV	5200	1.50	85	Warm White	63213540
MASTER TL-D Super 80 58W/840 SLV	5200	1.50	85	Cool White	63219740
MASTER TL-D Super 80 58W/865 SLV	5000	1.45	85	Cool Daylight	63225840

TL-D Snow White

Extreme Cool



TL-D Snow White



Cool light for pleasant and relaxing ambiances

Applications

- Suitable in a wide range of luminaires for TL-D Fluorescent lamps, used in applications where cool ambiances are requested like: offices, shops, schools, indoor ski centers, warehouses, industry, etc.

Why choose?

- Creates a relaxing and comfortable cool ambiance, especially in very hot and dry climate conditions
- Increases human well-being and contributes very positively to the perceived atmosphere
- Offers a very high colour temperature, a good colour rendering, direct replacement for any TL-D

Technical features

- Low-pressure mercury discharge lamps with a tubular 26 mm envelope

TL-D Snow White

Extreme Cool

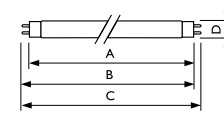

TL-D Snow White

Dimensions in mm	A		B	C		D
	max.	min.	max.	max.	max.	max.
TL-D 18W	509	595	597	604	28	
TL-D 36W	1199	1204	1207	1214	28	
TL-D 58W	1500	1505	1507	1514	25	

Preferred selection

Product ID	Packaging Configuration	Net weight	Lamp cap/Base	Colour Designation	Colour Temperature (K)	Colour Rendering Index (Ra)
TL-D 18W Snow White	25	71	G13	Extreme Cool Daylight	12000	78
TL-D 36W Snow White	25	137.5	G13	Extreme Cool Daylight	12000	78
TL-D 58W Snow White	25	186	G13	Extreme Cool Daylight	12000	78

Product ID	Lamp Voltage (V)	Lamp Wattage EM (W)	Lamp Current EM (mA)	Luminous Flux Lamp EM (Lm)	Luminance Average EM (cd/cm ²)	Order Code
TL-D 18W Snow White	59	18W	0.36	1050	0.75	89350540
TL-D 36W Snow White	103	36W	0.44	2500	0.95	89352940
TL-D 58W Snow White	111	58W	0.67	4000	1.15	89354340

MASTER TL-D Xtra

Lifetime



MASTER TL-D Xtra



Very long life

Applications

- MASTER TL-D Xtra is suitable for warehouses, food and drinks industries, airports, department stores, super markets, street lighting, car parks, large offices, hospitals

Why choose?

- Very long lifetime and few early failures reduce maintenance costs and hassle
- High efficiency, low operating costs
- Good colour rendering for a pleasant and productive environment
- Environment-friendly, low mercury content, less waste and reduced disposal cost at end of life
- Also available in Secura shatterproof and cold temperature polar versions

Technical Features

- Service life MASTER TL-D Xtra 24000 hrs (300% longer than standard T8 lamps)
- Good colour rendering ($R_a > 80$)
- Green X-cap
- Lowest mercury content on the market (3 mg)

MASTER TL-D Xtra

Lifetime

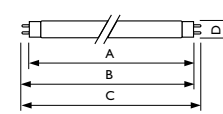

MASTER TL-D Xtra

Dimensions in mm	A	B	C	D
	max.	min.	max.	max.
MASTER TL-D Xtra	1199.4	1204.1	1206.5	1213.6
				28

Preferred selection

Product ID	Wattage (W)	Lumen	Order Code
			8711500
MASTER TL-D Xtra 830 SLV	18W	1350	54698840
MASTER TL-D Xtra 840 SLV	18W	1350	55862640
MASTER TL-D Xtra 830 SLV	36W	3350	55871840
MASTER TL-D Xtra 840 SLV	36W	3350	55876340
MASTER TL-D Xtra 840 SLV	58W	5200	55890940

MASTER TL-D Xtreme

Lifetime



MASTER TL-D Xtreme



Extremely long life

Applications

- MASTER TL-D Xtreme is suitable for offshore, car parks, underground stations, mining industry, street lighting

Why choose?

- Very long lifetime and few early failures reduce maintenance costs and hassle
- High efficiency, low operating costs
- Good colour rendering for a pleasant and productive environment
- Environment-friendly, low mercury content, less waste and reduced disposal cost at end of life
- Also available in Secura shatterproof and cold temperature polar versions

Technical Features

- Service life MASTER TL-D Xtreme 40000 hrs (500% longer than standard T8 lamps)
- Good colour rendering ($R_a > 80$)
- Green X-cap
- Lowest mercury content on the market (3 mg)

MASTER TL-D Xtreme

Lifetime

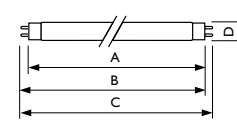

MASTER TL-D Xtreme

Dimensions in mm	A	B	C	D
	max.	min.	max.	max.
MASTER TL-D Xtreme	589.8	594.5	596.9	604.0
				28

Preferred selection

Product ID	Wattage (W)	Lumen	Order Code
MASTER TL-D Xtreme 830 SLV	18W	1350	54492640
MASTER TL-D Xtreme 840 SLV	18W	1350	54496440
MASTER TL-D Xtreme 830 SLV	36W	3250	55866440
MASTER TL-D Xtreme 840 SLV	36W	3250	55868840
MASTER TL-D Xtreme 840 SLV	58W	5150	55886240

TL-D Standard Colours

Standard



TL-D Standard Colours



Create atmospheres from warm white to cool daylight

Applications

- Suitable for use in a wide range of luminaires for TL-D Fluorescent lamps, used in applications where colour rendering is not an important factor

Why choose?

- Standard colours with moderate colour rendering
- Available in various colour designations
- Create atmospheres from warm white to cool daylight

Technical features

- Low-pressure mercury discharge lamps with a tubular 26mm envelope

TL-D Standard Colours

Standard

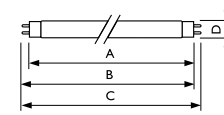

TL-D Standard Colours

Dimensions in mm	A	B	C	D	
	max.	min.	max.	max.	
TL-D 15W	437.4	442.1	444.5	451.6	28
TL-D 18W	589.8	594.5	596.9	604	28
TL-D 30W	894.6	899.3	901.7	908.8	28
TL-D 36W	1199.4	1204.1	1206.5	1213.6	28
TL-D 38W	1047	1051.7	1054.1	1061.2	28
TL-D 58W	1500	1504.7	1507.1	1514.2	28
TL-D 70W	1763.8	1768.5	1770.9	1778	28

TL-D Standard Colours

Standard

Preferred selection

Product ID	Packaging Configuration	Net weight per piece (g)	Cap/ Base	Colour Designation	Colour Temperature (K)	Colour Rendering Index (Ra)
TL-D 15W/33-640 SLV	25	76	G13	Cool White	4100	63
TL-D 15W/54-765 SLV	25	76	G13	Cool Daylight	6200	72
TL-D 18W/33-640 SLV	25	71	G13	Cool White	4100	63
TL-D 18W/54-765 SLV	25	71	G13	Cool Daylight	6200	72
TL-D 23W/33-640 SLV	25	120	G13	Cool White	4100	63
TL-D 23W/54-765 SLV	25	120	G13	Cool Daylight	6200	72
TL-D 30W/33-640 SLV	25	113	G13	Cool White	4100	63
TL-D 30W/54-765 SLV	25	113	G13	Cool Daylight	6200	72
TL-D 36W/33-640 SLV	25	137.5	G13	Cool White	4100	63
TL-D 36W/54-765 SLV	25	137.5	G13	Cool Daylight	6200	72
TL-D 38W/33-640 SLV	25	133	G13	Cool White	4100	63
TL-D 58W/33-640 SLV	25	186	G13	Cool White	4100	63
TL-D 58W/54-765 SLV	25	186	G13	Cool Daylight	6200	72
TL-D 70W/33-640 SLV	25	214	G13	Cool White	4100	63

SLV: Sleeve packaging

Product ID	Lamp Voltage (V)	Lamp Wattage EM (W)	Lamp Current EM (A)	Luminous Flux Lamp EM (lm)	Luminance Average EM (cd/cm ²)	Energy Efficiency Label	Order Code
TL-D 15W/33-640 SLV	51	15	0.34	960	0.95	B	8711500 70277740
TL-D 15W/54-765 SLV	51	15	0.34	830	0.85	B	72221840
TL-D 18W/33-640 SLV	59	18	0.36	1200	0.85	B	70266140
TL-D 18W/54-765 SLV	59	18	0.36	1050	0.75	B	70267840
TL-D 23W/33-640 SLV	95	23	0.3	1900	0.9	A	72638440
TL-D 23W/54-765 SLV	95	23	0.3	1550	0.7	B	72641440
TL-D 30W/33-640 SLV	98	30	0.36	2100	1.05	B	70282140
TL-D 30W/54-765 SLV	98	30	0.36	1825	0.9	B	72263840
TL-D 36W/33-640 SLV	103	36	0.44	2850	1.05	B	70270840
TL-D 36W/54-765 SLV	103	36	0.44	2500	0.95	B	70271540
TL-D 38W/33-640 SLV	104	38	0.43	3100	1.2	B	72669840
TL-D 58W/33-640 SLV	111	58.5	0.67	4600	1.35	B	70274640
TL-D 58W/54-765 SLV	111	58.5	0.67	4000	1.15	B	70275340
TL-D 70W/33-640 SLV	132	70	0.69	5250	1.3	B	61837540

SLV: Sleeve packaging

TL-D Standard Colours

Standard

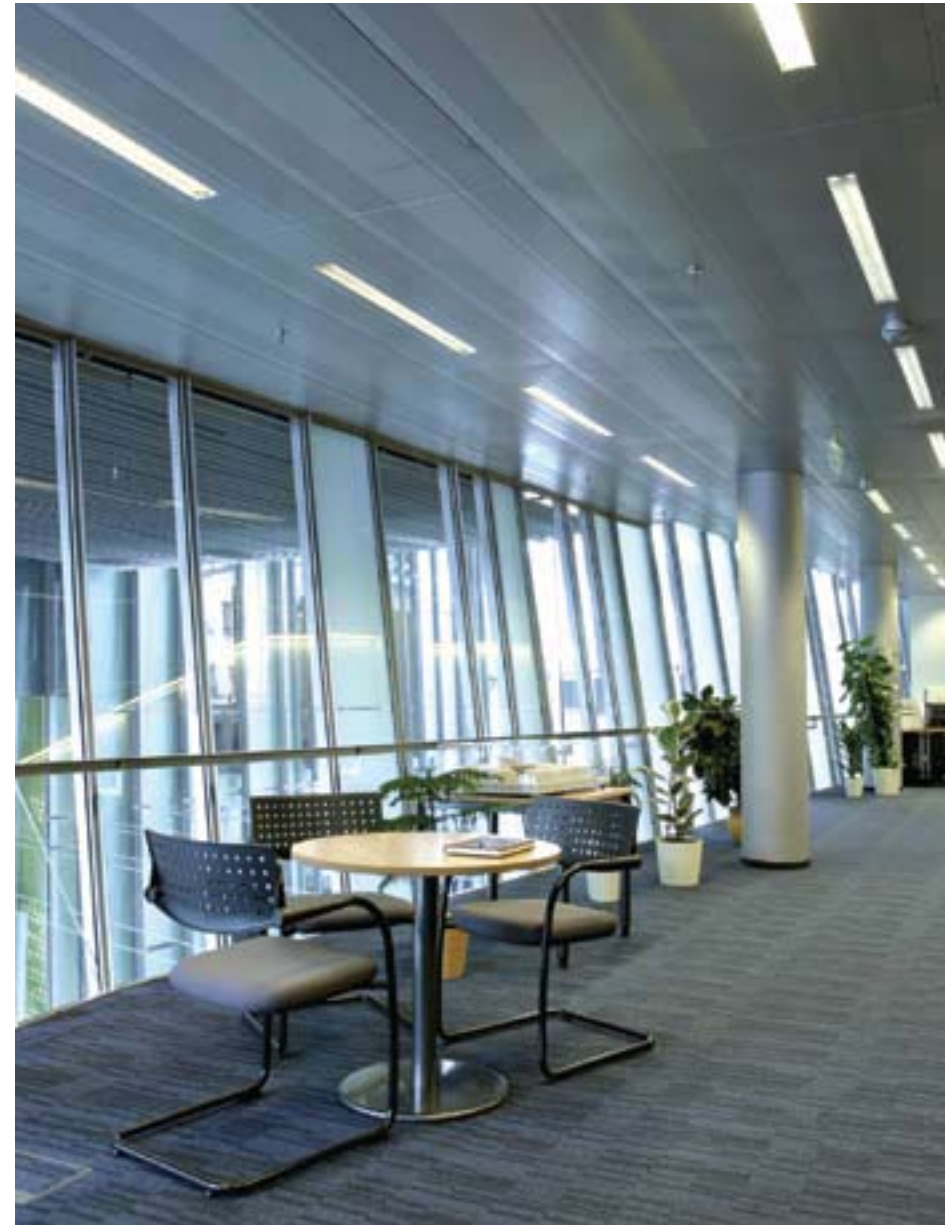

TL-E Standard Colours

Standard



TL-E Standard Colours



Create atmosphere
from warm white to
cool daylight

Applications

- Suitable for use in a wide range of luminaires for various purposes, including many decorative luminaires where colour rendering is not important

Why choose?

- Symmetrical, omnidirectional light distribution
- Create atmosphere from warm white to cool daylight

Technical features

- Low-pressure mercury discharge lamps with a circular 26 mm tube

TL-E Standard Colours

Standard

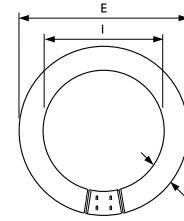

TL-E Standard Colours

Dimensions in mm	D		E		I	
	min.	max.	min.	max.	min.	max.
TL-E 22W	26.2	30.9	200	219	147.6	157.2
TL-E 32W	26.2	30.9	288.9	307.9	236.5	246.1
TL-E 40W	26.2	30.9	390.5	409.5	338.1	347.7

Preferred selection

Product ID	Packaging Configuration	Net weight per piece	Cap/ Base	Colour Designation	Colour Temperature	Colour Rendering Index (Ra)
TL-E 22W/54-765 ICT	12	156	G10q (g)	Cool Daylight	6200 (K)	72
TL-E 32W/54-765 ICT	12	262	G10q	Cool Daylight	6200	72
TL-E 40W/54-765 ICT	12	336	G10q	Cool Daylight	6200	72

Product ID	Lamp Voltage	Lamp Wattage	Lamp Current	Luminous Flux Lamp	Luminous Efficacy Lamp	Luminance Average	Energy Efficiency	Order Code
	(V)	(W)	(A)	(lm)	(lm/W)	(cd/cm ²)	Label	8711500
TL-E 22W/54-765 ICT	62	22	0.4	1050	48	0.7	B	63390315
TL-E 32W/54-765 ICT	81	32	0.45	1750	57	0.65	B	63387315
TL-E 40W/54-765 ICT	110	40	0.42	2500	62	0.65	B	55991315

TL Mini Standard Colours

Limited space



TL Mini Standard Colours



Small directional

Applications

- Ideal for applications where space is limited and colour rendering is not important
- Orientation lighting
- Emergency lighting

Why choose?

- Creates atmospheres from warm white to cool daylight

Technical features

- 16 mm diameter tubes with moderate colour rendering

TL Mini Standard Colours

Limited space

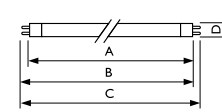

TL Mini Standard Colours

Dimensions in mm	A		B		C		D	
	max.	min.	max.	min.	max.	min.	max.	min.
TL 6W	212.1	216.8	219.2	226.3	16			
TL 8W	288.3	293.0	295.4	302.5	16			
TL 13W	516.9	521.6	524.0	531.1	16			

Preferred selection

Product ID	Packaging Configuration	Net weight per piece (g)	Cap/Base	Colour Designation	Colour Temperature (K)	Colour Rendering Index (Ra)
TL Mini 6W/33-640 FAM	10x25BOX	21	G5	Cool White	4100	60
TL Mini 6W/54-765 FAM	10x25BOX	22	G5	Cool Daylight	6200	75
TL Mini 8W/33-640 FAM	10x25BOX	29	G5	Cool White	4100	60
TL Mini 8W/54-765 FAM	10x25BOX	29	G5	Cool Daylight	6200	75
TL Mini 13W/33-640 FAM	10x25BOX	45	G5	Cool White	4100	60
TL Mini 13W/54-765 FAM	10x25BOX	45	G5	Cool Daylight	6200	75

SLV: Sleeve packaging

Product ID	Lamp Voltage (V)	Lamp Wattage EM (W)	Lamp Current EM (A)	Luminous Flux Lamp EM (lm)	Luminous Efficacy Lamp EM (lm/W)	Luminance Average EM (cd/cm ²)	Energy Efficiency Label	Order Code
TL Mini 6W/33-640 FAM	42	6	0,16	260	43	0,85	B	71583827
TL Mini 6W/54-765 FAM	42	6	0,16	230	38	0,7	B	71597527
TL Mini 8W/33-640 FAM	56	7,1	0,15	410	51	0,9	B	70473327
TL Mini 8W/54-765 FAM	56	7,1	0,15	340	48	0,75	B	71628627
TL Mini 13W/33-640 FAM	90	13	0,17	930	71	1,1	A	70475727
TL Mini 13W/54-765 FAM	90	13	0,17	740	57	0,9	B	71671227

SLV: Sleeve packaging

MASTER TL-D ECO

Simple energy savings



TL-D ECO



10% extra energy savings

Applications

- Indoor working areas (office, public/government buildings, schools, hospitals, etc.) with ambient temperatures above 15°C
- High-quality lighting with good color rendering (CRI>80)
- Helps reduce CO₂ emissions and meet climate change targets
- Philips Green Flagship label due to extremely low mercury levels

Why choose?

- Low-pressure mercury discharge lamps with a tubular 26 mm envelope
- Simple lamp-for-lamp replacement for more than 10% energy savings
- Makes lighting installations compliant with latest indoor lighting standards
- Relatively high efficacy, both initially and during lifetime, with high lumen maintenance

MASTER TL-D ECO

Simple energy savings

Dimensions in mm	A	B	C		D
	max.	min.	max.	max.	max.
MASTER TL-D Eco 32W/865 ISL	1199.4	1204.1	1206.5	1213.6	28

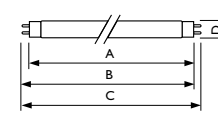

TL-D ECO

Preferred selection

Product ID	Wattage (W)	Net weight per piece (g)	Cap/ Base	Colour Temperature (K)	Colour Rendering Index (R _a)	Colour Designation	Order Code
							8711500
MASTER TL-D Eco 32W/830 ISL	32	138	G13	3000	85	Warm White	26458940
MASTER TL-D Eco 32W/840 ISL	32	138	G13	4000	85	Cool White	26462640
MASTER TL-D Eco 32W/865 ISL	32	138	G13	6500	85	Cool Day Light	26464040
MASTER TL-D Eco 51W/830 ISL	51	173	G13	3000	85	Warm White	26466440
MASTER TL-D Eco 51W/840 ISL	51	173	G13	4000	85	Cool White	26470140
MASTER TL-D Eco 51W/865 ISL	51	173	G13	6500	85	Cool Day Light	26472540



Halogen Lamps



MASTER Line ES

LV Halogen with Reflector



MASTER Line ES



40% less energy, less heat

Applications

- Accent and general lighting applications in homes, shops, hotels and restaurants, where energy efficiency and low maintenance are important and especially in art galleries, museums and exhibitions

Why choose?

- Energy efficiency 40% better than standard products
- Bright, sparkling white halogen light
- Excellent colour rendering
- Extreme long average rated life

Product Features

- Energy saving, low voltage halogen reflector lamp of the MASTER collection, with dichroic reflector and infra red coated double ended burner
- Unique Philips patented Infra red coated double ended burner with the highest possible efficiency (40% better than standard products)

Luminaires

- Can be used in luminaires without front glass in accordance with IEC 598

MASTER Line ES

LV Halogen with Reflector

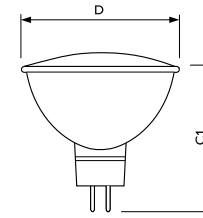

MASTER Line ES

Dimensions in mm	C	D
	max.	max.
MASTER Line ES	50.5	51

Preferred selection

Product ID	Voltage (V)	Wattage (W)	Beam Angle	Cap/ Base	Luminous Intensity (cd)	Average Life (h)	Order Code 8711500
MASTER Line ES	12V	20W	8D	GU5.3	6500	5000	41364271
MASTER Line ES	12V	20W	36D	GU5.3	1000	5000	41367371
MASTER Line ES	12V	30W	8D	GU5.3	11000	5000	41370371
MASTER Line ES	12V	30W	24D	GU5.3	3350	5000	41375871
MASTER Line ES	12V	30W	36D	GU5.3	1600	5000	41378971
MASTER Line ES	12V	30W	60D	GU5.3	750	5000	41382671
MASTER Line ES	12V	35W	8D	GU5.3	14000	5000	41387171
MASTER Line ES	12V	35W	24D	GU5.3	4400	5000	41397071
MASTER Line ES	12V	35W	36D	GU5.3	2200	5000	42432771
MASTER Line ES	12V	35W	60D	GU5.3	1050	5000	42435871
MASTER Line ES	12V	45W	8D	GU5.3	16000	5000	42438971
MASTER Line ES	12V	45W	24D	GU5.3	5450	5000	42441971
MASTER Line ES	12V	45W	36D	GU5.3	2850	5000	42444071
MASTER Line ES	12V	45W	60D	GU5.3	1300	5000	42447171

Essential Dichroic MRI6

LV Halogen with Reflector



MRI6



Crisp, white light

Applications

- Accent, task lighting and decorative applications in homes, shops, hotels and restaurants

Why choose?

- Good light quality with cool beam halogen crisp, white light
- Professional lifetime
- Dimmable

Technical features

- The dichroic reflector coating transmits the heat towards the back and reflects the visible light towards the front of the lamp
- UV-Block burner
- Excellent colour rendering
- GU5.3 base for extra retention in luminaire

Luminaires

- Can be used in luminaires without a front glass in accordance with IEC 598

Essential Dichroic MRI6

LV Halogen with Reflector

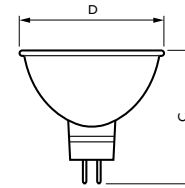

MRI6

Burning position



Universal

Dimensions in mm	C	D
MRI6 GU5.3	46	50

Product ID	Voltage (V)	Wattage (W)	Cap/Base	Half Intensity Beam angle (degrees)	Luminous Intensity (cd)	Average Life (h)	Colour Temperature (K)	Order Code
ESS MRI6	12	20	GU5.3	36	400	2000	2900	88592065
ESS MRI6	12	35	GU5.3	36	800	2000	2900	88593760
ESS MRI6	12	50	GU5.3	36	1200	2000	2900	88594465

Maximum permissible temperatures	
Reflector	250°
Reflector rim	240°
Pinch	350°
Contacts	300°

Capsuline

LV Halogen without Reflector



CAP LS GY6.35



Brighter light

Applications

- Task lighting and decorative applications in homes, shops, hotels and restaurants

Why choose?

- Low-pressure technology allows use in luminaires without front glass

Technical features

- Sturdy, low-pressure lamps with UV-Block glass (IEC 357)
- Gas-filled (≤ 2.5 bar) lamps can be used in luminaires without a front glass in accordance with IEC 598
- Axial filament for higher light output in combination with luminaires and a uniform beam
- Excellent colour rendering
- Universal burning position

Capsuline

LV Halogen without Reflector

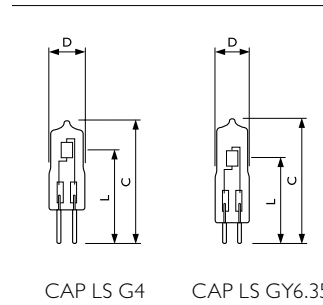

CAP LS G4 CAP LS GY6.35

Dimensions in mm	C	D	L
	max.	max.	nom.
CAP G4 10W	31	9	22
CAP G4 80W	32	9	22
CAP GY6.35 50W	44	12	30

Preferred selection

Product ID	Voltage (V)	Wattage (W)	Cap/ Base	Luminous Intensity (cd)	Average Life (h)	Order Code
Capsuline	12V	10W	G4	120	2000	871 1500
Capsuline	12V	20W	G4	300	2000	41233150
Capsuline	12V	50W	GY6.35	800	2000	42839446

Essential Twistline Alu

MV Halogen with Reflector



TWIST Alu GU10



Easy to install

Applications

- Typically used for accent lighting in homes
- Also used in accent and general lighting in shops, hotels, restaurants, bars etc

Why choose?

- Lamp can be connected directly to the mains supply, so no transformers are needed
- UV-Block lamp so no additional front glass or UV filter required
- Twistline dichroic and aluminium versions are the most compact lamps of their kind available

Technical features

- Quartz burner with filament optically positioned in an aluminium-coated reflector
- Aluminium-coated version (GU10 lamp base) directs most of its heat to the front
- No light goes to the back of the reflector
- Clear front glass protects against touching the burner and against dust/moisture

Essential Twistline Alu

MV Halogen with Reflector

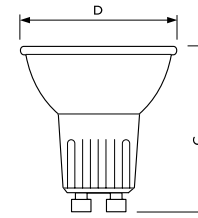

TWIST Alu GU10

Dimensions in mm	C	D
	max.	max.
Twistline Alu GU10	51	51

Preferred selection

Product ID	Voltage (V)	Wattage (W)	Beam Angle	Cap/ Base	Luminous Intensity (cd)	Average Life (h)	Order Code
Essential Twistline Alu	230V	35W	40D	GU10	250	2000	88767260
Essential Twistline Alu	240V	35W	40D	GU10	250	2000	88768960
Essential Twistline Alu	230V	50W	40D	GU10	400	2000	88769660
Essential Twistline Alu	240V	50W	40D	GU10	400	2000	88770260

Plusline (Double Ended)

MV Halogen without Reflector



Plusline Small R7s



Create a brighter atmosphere

Applications

- Typically used in shop lighting applications
- Indoor: homes, offices, shops and museums
- Outdoor: billboards, car parks, security lighting and construction sites
- Excellent colour rendering

Why choose?

- 20% more light than ordinary double-ended
- Long lifetime
- Bright halogen light
- Excellent colour rendering

Technical Features

- Double-ended high-efficacy lamps
- Clear tubular UV block quartz bulb
- Constant light output during life
- Must be used in luminaires with a front cover glass

Plusline (Double Ended)

MV Halogen without Reflector

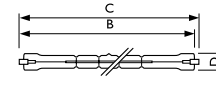

Plusline

Dimensions in mm	B	C	D
	nom.	max.	max.
Plusline Small	114.2	117.6	12
Plusline Compact	74.9	78.3	12
Plusline Large 1000W	185.7	189.1	11
Plusline Large 1500W	250.7	254.1	11

Preferred selection

Product ID	Voltage	Wattage	Cap/Base	Luminous	Average	Colour	Packaging	Order Code
	(V)	(W)		(Lm)	Lifetime (hrs)	Temperature (K)		
PlusLine Compact	230	60	R7s	810	1500	2900	blisbox	871 1500 49472626
PlusLine Compact	230	100	R7s	1550	2000	2900	blisbox	05833126
PlusLine Compact	230	150	R7s	2400	2000	2900	blisbox	05834826
PlusLine Compact	240	100	R7s	1550	2000	2900	blisbox	05827026
PlusLine Compact	240	150	R7s	2400	2000	2900	blisbox	05828726
PlusLine Small	230	200	R7s	3000	2000	2900	blisbox	49437526
PlusLine Small	230	300	R7s	5114	2000	2900	blisbox	49438226
PlusLine Small	230	500	R7s	9660	2000	2900	blisbox	49439926
PlusLine Small	240	200	R7s	3000	2000	2900	blisbox	05829426
PlusLine Small	240	300	R7s	5114	2000	2900	blisbox	05831726
PlusLine Small	240	500	R7s	9660	2000	2900	blisbox	05832426
PlusLine Small	120	500	R7s	9500	2000	2900	blisbox	49463426
Plusline Large	230	1000	R7s	21500	2000	2900	etui	49434425
Plusline Large	240	1000	R7s	21500	2000	2900	etui	05597225
Plusline Large	240	1500	R7s	32250	2000	2900	etui	05599625
Plusline Large	120	1000	R7s	21500	2000	2900	etui	49485625

EcoClassic 30

Energy saving



EcoClassic 30 clear



30% energy saving halogen

Applications

- General lighting applications in homes, shops, hotels and restaurants

Why choose?

- Sparkling, crisp white halogen light of professional quality
- 30% energy savings compared with classic incandescent lamps
- Creates an attractive ambiance
- Dimmable

Technical Features

- Direct retrofit for the corresponding incandescent lamps
- Wide choice of wattages to replace classic incandescent range from 40W to 200W
- Available with E27, E14 and B22 caps. Also in frosted and clear versions
- 2000 hrs lifetime

EcoClassic 30

Energy saving



EcoClassic 30

Operational position



Universal

Dimensions in mm	C	D
	max.	max.
EcoClassic 30	107	61

Preferred selection

Product ID	Voltage (V)	Wattage (W)	Output of	Energy Saving	Finish	Cap/ Base	Average life (hrs)	Order Code
EcoClassic 30 Standard Shape	230V	42W	60W	30%	Clear	E27	2000	8727900
EcoClassic 30 Standard Shape	230V	53W	75W	30%	Clear	E27	2000	25171525
EcoClassic 30 Standard Shape	230V	70W	100W	30%	Clear	E27	2000	25172225
EcoClassic 30 Standard Shape	230V	105W	150W	30%	Clear	E27	2000	25225525
EcoClassic 30 Standard Shape	230V	140W	200W	30%	Clear	E27	2000	25255225
EcoClassic 30 Standard Shape	230V	42W	60W	30%	Frosted	E27	2000	25175325
EcoClassic 30 Standard Shape	230V	53W	75W	30%	Frosted	E27	2000	25176025
EcoClassic 30 Standard Shape	230V	70W	100W	30%	Frosted	E27	2000	25177725
EcoClassic 30 Standard Shape	230V	105W	150W	30%	Frosted	E27	2000	25178425
EcoClassic 30 Standard Shape	230V	140W	200W	30%	Frosted	E27	2000	25256925
EcoClassic 30 Standard Shape	240V	42W	60W	30%	Clear	B22	2000	25187625
EcoClassic 30 Standard Shape	240V	53W	75W	30%	Clear	B22	2000	25188325
EcoClassic 30 Standard Shape	240V	70W	100W	30%	Clear	B22	2000	25189025
EcoClassic 30 Standard Shape	240V	105W	150W	30%	Clear	B22	2000	25190625
EcoClassic 30 Standard Shape	240V	42W	60W	30%	Frosted	B22	2000	25191325
EcoClassic 30 Standard Shape	240V	53W	75W	30%	Frosted	B22	2000	25192025
EcoClassic 30 Standard Shape	240V	70W	100W	30%	Frosted	B22	2000	25193725
EcoClassic 30 Standard Shape	240V	105W	150W	30%	Frosted	B22	2000	25194425
EcoClassic 30 Standard Shape	240V	140W	200W	30%	Frosted	B22	2000	25260625
EcoClassic 30 Standard Shape	240V	42W	60W	30%	Clear	E27	2000	25179125
EcoClassic 30 Standard Shape	240V	53W	75W	30%	Clear	E27	2000	25180725
EcoClassic 30 Standard Shape	240V	70W	100W	30%	Clear	E27	2000	25181425
EcoClassic 30 Standard Shape	240V	105W	150W	30%	Clear	E27	2000	25182125
EcoClassic 30 Standard Shape	240V	42W	60W	30%	Frosted	E27	2000	25183825
EcoClassic 30 Standard Shape	240V	53W	75W	30%	Frosted	E27	2000	25184525
EcoClassic 30 Standard Shape	240V	70W	100W	30%	Frosted	E27	2000	25185225
EcoClassic 30 Standard Shape	240V	105W	150W	30%	Frosted	E27	2000	25186925
EcoClassic 30 Standard Shape	240V	140W	200W	30%	Frosted	E27	2000	25259025



Incandescent Lamps



Standard (A-shape)

Incandescent



A55 E27 Clear



Standard good quality light

Applications

- Frosted lamps give low glare and diffused lighting for universal applicability
- Clear lamps are ideal for indirect lighting in closed luminaires, and where brilliance and sparkling effects are more important than reduction of glare

Why choose?

- Good quality of light

Technical features

- Vacuum-filled (15W) or gas-filled (25W and above)
- Product description
- Conventional pear-shaped incandescent lamps

Standard (A-shape)

Incandescent

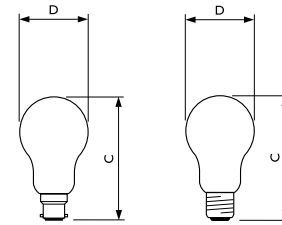

A55 B22

A55 E27

Dimensions in mm	C	D
A55 B22	93	55
A55 E27	96	55

Burning position



Universal

Standard (A-shape)

Incandescent

Preferred selection

Product ID	Lamp Voltage (V)	Bulb Shape	Cap/ Base	Finish	Luminous Flux Lamp (Lm)	Avg Lifetime (hrs)	Packaging Configuration	Packaging Type	Order Code
Clear									
STANDARD A55 25W	230V	A55	E27	CL	220	1000	120	ICT	7563184
STANDARD A55 25W	230V	A55	B22	CL	220	1000	120	ICT	7558784
STANDARD A55 40W	230V	A55	E27	CL	415	1000	120	ICT	7564884
STANDARD A55 40W	230V	A55	B22	CL	415	1000	120	ICT	7559484
STANDARD A55 60W	230V	A55	E27	CL	710	1000	120	ICT	7565584
STANDARD A55 60W	230V	A55	B22	CL	710	1000	120	ICT	7560084
STANDARD A55 75W	230V	A55	E27	CL	930	1000	120	ICT	7566284
STANDARD A55 75W	230V	A55	B22	CL	930	1000	120	ICT	7561784
STANDARD A55 100W	230V	A55	E27	CL	1340	1000	120	ICT	7562484
STANDARD A55 100W	230V	A55	B22	CL	1340	1000	120	ICT	7557084
8710163									
Frosted									
STANDARD A55 25W	240V	A55	E27	CL	215	1000	120	ICT	7572384
STANDARD A55 25W	240V	A55	B22	CL	215	1000	120	ICT	7568684
STANDARD A55 40W	240V	A55	E27	CL	410	1000	120	ICT	7573084
STANDARD A55 40W	240V	A55	B22	CL	410	1000	120	ICT	7569384
STANDARD A55 60W	240V	A55	E27	CL	700	1000	120	ICT	7574784
STANDARD A55 60W	240V	A55	B22	CL	700	1000	120	ICT	7570984
STANDARD A55 75W	240V	A55	E27	CL	920	1000	120	ICT	7575484
STANDARD A55 100W	240V	A55	E27	CL	1330	1000	120	ICT	7571684
STANDARD A55 100W	240V	A55	B22	CL	1330	1000	120	ICT	7567984
125-130V									
STANDARD A55 25W	125-130V	A55	E27	CL	260	1000	120	ICT	7553284
STANDARD A55 40W	125-130V	A55	E27	CL	490	1000	120	ICT	7554984
STANDARD A55 60W	125-130V	A55	E27	CL	820	1000	120	ICT	7555684
STANDARD A55 75W	125-130V	A55	E27	CL	1070	1000	120	ICT	7556384
STANDARD A55 100W	125-130V	A55	E27	CL	1560	1000	120	ICT	7552584

Standard (A-shape)

Incandescent

Product ID	Lamp Voltage (V)	Bulb Shape	Cap/ Base	Finish	Luminous Flux Lamp (Lm)	Avg Lifetime (hrs)	Packaging Configuration	Packaging Type	Order Code
8710163									
Frosted									
STANDARD A55 25W	230V	A55	E27	FR	220	1000	120	ICT	7535884
STANDARD A55 25W	230V	A55	B22	FR	220	1000	120	ICT	7529784
STANDARD A55 40W	230V	A55	E27	FR	415	1000	120	ICT	7536584
STANDARD A55 40W	230V	A55	B22	FR	415	1000	120	ICT	7530384
STANDARD A55 60W	230V	A55	E27	FR	710	1000	120	ICT	7537284
STANDARD A55 60W	230V	A55	B22	FR	710	1000	120	ICT	7531084
STANDARD A55 75W	230V	A55	E27	FR	930	1000	120	ICT	7538984
STANDARD A55 75W	230V	A55	B22	FR	930	1000	120	ICT	7532784
STANDARD A55 100W	230V	A55	E27	FR	1340	1000	120	ICT	7533484
STANDARD A55 100W	230V	A55	B22	FR	1340	1000	120	ICT	7528084
240V									
STANDARD A55 25W	240V	A55	E27	FR	215	1000	120	ICT	7545784
STANDARD A55 25W	240V	A55	B22	FR	215	1000	120	ICT	7540284
STANDARD A55 40W	240V	A55	E27	FR	410	1000	120	ICT	7546484
STANDARD A55 40W	240V	A55	B22	FR	410	1000	120	ICT	7541984
STANDARD A55 60W	240V	A55	E27	FR	700	1000	120	ICT	7547184
STANDARD A55 60W	240V	A55	B22	FR	700	1000	120	ICT	7542684
STANDARD A55 75W	240V	A55	E27	FR	920	1000	120	ICT	7548884
STANDARD A55 75W	240V	A55	B22	FR	920	1000	120	ICT	7543384
STANDARD A55 100W	240V	A55	E27	FR	1330	1000	120	ICT	7544084
STANDARD A55 100W	240V	A55	B22	FR	1330	1000	120	ICT	7539684
125-130V									
STANDARD A55 25W	125-130V	A55	E27	FR	260	1000	120	ICT	7524284
STANDARD A55 40W	125-130V	A55	E27	FR	490	1000	120	ICT	7525984
STANDARD A55 40W	125-130V	A55	B22	FR	490	1000	120	ICT	7521184
STANDARD A55 60W	125-130V	A55	E27	FR	820	1000	120	ICT	7526684
STANDARD A55 60W	125-130V	A55	B22	FR	820	1000	120	ICT	7522884
STANDARD A55 75W	125-130V	A55	E27	FR	1070	1000	120	ICT	7527384
STANDARD A55 100W	125-130V	A55	E27	FR	1560	1000	120	ICT	7523584
STANDARD A55 100W	125-130V	A55	B22	FR	1560	1000	120	ICT	7520484

Standard Candle (B-shape)

Incandescent



B35 Clear



Good quality light

Applications

- Home use in living and dining rooms, bedrooms, halls and studies
- Hotel lounges, restaurants, bedrooms, halls, conference rooms and foyers
- Clubs and social areas, Ballrooms, Shops and boutiques, Churches

Why choose?

- Decorative shape; good quality of light
- The clear types are at their best in decorative glass chandeliers and wall brackets with clear or textured glass bowls. Their brilliant, visible filament adds small points of brightness for an enriched lighting effect
- The frosted types are graceful lamps that enhance the elegance of classical chandeliers, candelabras, wall brackets etc. They set the scene for cosiness and comfort, and can be used with or without lampshades

Technical features

- The slender, crystal-clear lamps are designed for sparkling highlights, they create a classic sparkling atmosphere
- The slender, frosted lamps create a low glare atmosphere

Standard Candle (B-shape)

Incandescent

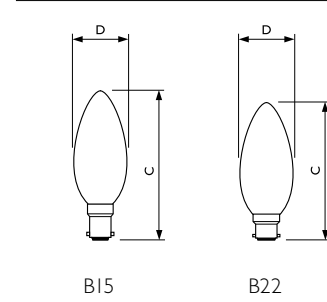

B15

B22

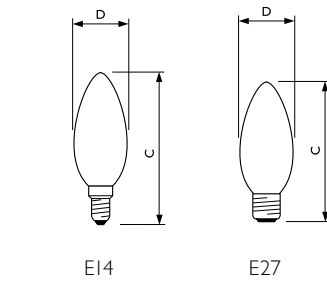

E14

E27

Dimensions in mm	C	D
Candle B15	97	35
Candle B22	94	35
Candle E14	99	35
Candle E27	95	35

Burning position



Universal

Standard Candle (B-shape)

Incandescent

Preferred selection

Product ID	Lamp Voltage (V)	Bulb Shape	Cap/ Base	Finish	Luminous Flux Lamp (Lm)	Avg Lifetime (hrs)	Packaging Configuration	Packaging Type	Order Code
Clear									8710163
CANDLE B35 15W	230V	B35	E14	CL	115	1000	100	ICT	7579250
CANDLE B35 25W	230V	B35	E14	CL	210	1000	100	ICT	7580850
CANDLE B35 40W	230V	B35	E14	CL	410	1000	100	ICT	7581550
CANDLE B35 40W	230V	B35	E27	CL	410	1000	100	ICT	7583950
CANDLE B35 60W	230V	B35	E14	CL	690	1000	100	ICT	7582250
CANDLE B35 25W	240V	B35	E14	CL	210	1000	100	ICT	7584650
CANDLE B35 40W	240V	B35	E14	CL	405	1000	100	ICT	7585350
CANDLE B35 40W	240V	B35	E27	CL	405	1000	100	ICT	7587750
CANDLE B35 60W	240V	B35	E14	CL	670	1000	100	ICT	7586050
CANDLE B35 25W	125-130V	B35	E14	CL	255	1000	100	ICT	7576150
CANDLE B35 40W	125-130V	B35	E14	CL	480	1000	100	ICT	7577850
CANDLE B35 60W	125-130V	B35	E14	CL	710	1000	100	ICT	7578550

Preferred selection

Product ID	Lamp Voltage (V)	Bulb Shape	Cap/ Base	Finish	Luminous Flux Lamp (Lm)	Avg Lifetime (hrs)	Packaging Configuration	Packaging Type	Order Code
Frosted									8710163
CANDLE B35 15W	230V	B35	E14	FR	115	1000	100	ICT	7591450
CANDLE B35 25W	230V	B35	E14	FR	215	1000	100	ICT	7592150
CANDLE B35 40W	230V	B35	B22	FR	410	1000	100	ICT	7505150
CANDLE B35 40W	230V	B35	E14	FR	410	1000	100	ICT	7593850
CANDLE B35 40W	230V	B35	E27	FR	410	1000	100	ICT	7596950
CANDLE B35 60W	230V	B35	E14	FR	670	1000	100	ICT	7594550
CANDLE B35 25W	240V	B35	E14	FR	210	1000	100	ICT	7598350
CANDLE B35 40W	240V	B35	B15	FR	405	1000	100	ICT	7597650
CANDLE B35 40W	240V	B35	E14	FR	405	1000	100	ICT	7599050
CANDLE B35 40W	240V	B35	E27	FR	405	1000	100	ICT	7601050
CANDLE B35 60W	240V	B35	E14	FR	670	1000	100	ICT	7600350
CANDLE B35 60W	240V	B35	E27	FR	670	1000	100	ICT	7602750
CANDLE B35 25W	125-130V	B35	E14	FR	255	1000	100	ICT	7588450
CANDLE B35 40W	125-130V	B35	E14	FR	480	1000	100	ICT	7589150
CANDLE B35 60W	125-130V	B35	E14	FR	710	1000	100	ICT	7590750

Standard Candle (B-shape)

Incandescent



Standard Lustre (P-shape)

Incandescent



P45 E14 Clear



Good quality light

Applications

- Home use in living and dining rooms, bedrooms, halls and studies
- Hotel lounges, restaurants, bedrooms, halls, conference rooms and foyers
- Clubs and social areas
- Shops, boutiques and department stores

Why choose?

- The clear versions with their brilliant, visible filament add small points of brightness for an enriched lighting effect
- The frosted types create softly diffused light to set the scene for cosiness and comfort, and meet both aesthetic and functional requirements

Technical features

- Lamps with reduced size and neat shape
- The small, crystal-clear lamps are designed for sparkling highlights. They are at their best in decorative small luminaires such as table models and wall brackets with clear glass bowls where they create a sparkling atmosphere
- They create a pleasant low glare atmosphere

Standard Lustre (P-shape)

Incandescent

Dimensions in mm	C	D
Lustre B22	70	45
Lustre E14	77	45
Lustre E27	72	45

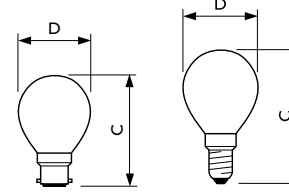

B22

E27

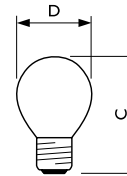

E14

Burning position

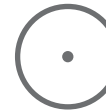

Universal

Standard Lustre (P-shape)

Incandescent

Preferred selection

Product ID	Lamp Voltage (V)	Bulb Shape	Cap/ Base	Finish	Luminous Flux Lamp (Lm)	Avg Lifetime (hrs)	Packaging Configuration	Packaging Type	Order Code
Clear									
LUSTRE P45 15W	230V	P45	E27	CL	115	1000	100	ICT	7614050
LUSTRE P45 25W	230V	P45	B22	CL	205	1000	100	ICT	7609650
LUSTRE P45 25W	230V	P45	E14	CL	205	1000	100	ICT	7611950
LUSTRE P45 25W	230V	P45	E27	CL	205	1000	100	ICT	7615750
LUSTRE P45 40W	230V	P45	B22	CL	405	1000	100	ICT	7610250
LUSTRE P45 40W	230V	P45	E14	CL	405	1000	100	ICT	7612650
LUSTRE P45 40W	230V	P45	E27	CL	405	1000	100	ICT	7616450
LUSTRE P45 60W	230V	P45	E14	CL	650	1000	100	ICT	7613350
LUSTRE P45 60W	230V	P45	E27	CL	650	1000	100	ICT	7617150
LUSTRE P45 25W	240V	P45	E14	CL	210	1000	100	ICT	7618850
LUSTRE P45 25W	240V	P45	E27	CL	210	1000	100	ICT	7620150
LUSTRE P45 40W	240V	P45	E14	CL	400	1000	100	ICT	7619550
LUSTRE P45 40W	240V	P45	E27	CL	400	1000	100	ICT	7621850
LUSTRE P45 25W	125-130V	P45	E27	CL	255	1000	100	ICT	7606550
LUSTRE P45 40W	125-130V	P45	E27	CL	480	1000	100	ICT	7607250
LUSTRE P45 60W	125-130V	P45	E27	CL	710	1000	100	ICT	7608950

Preferred selection

Product ID	Lamp Voltage (V)	Bulb Shape	Cap/ Base	Finish	Luminous Flux Lamp (Lm)	Avg Lifetime (hrs)	Packaging Configuration	Packaging Type	Order Code
Frosted									
LUSTRE P45 15W	230V	P45	E14	FR	120	1000	100	ICT	7630050
LUSTRE P45 15W	230V	P45	E27	FR	120	1000	100	ICT	7634850
LUSTRE P45 25W	230V	P45	B22	FR	215	1000	100	ICT	7627050
LUSTRE P45 25W	230V	P45	E14	FR	215	1000	100	ICT	7631750
LUSTRE P45 25W	230V	P45	E27	FR	215	1000	100	ICT	7635550
LUSTRE P45 40W	230V	P45	B22	FR	405	1000	100	ICT	7628750
LUSTRE P45 40W	230V	P45	E14	FR	405	1000	100	ICT	7632450
LUSTRE P45 40W	230V	P45	E27	FR	405	1000	100	ICT	7636250
LUSTRE P45 60W	230V	P45	B22	FR	650	1000	100	ICT	7629450
LUSTRE P45 60W	230V	P45	E14	FR	650	1000	100	ICT	7633150
LUSTRE P45 60W	230V	P45	E27	FR	650	1000	100	ICT	7637950
LUSTRE P45 25W	240V	P45	E14	FR	210	1000	100	ICT	7638650
LUSTRE P45 25W	240V	P45	E27	FR	210	1000	100	ICT	7640950
LUSTRE P45 40W	240V	P45	E14	FR	400	1000	100	ICT	7639350
LUSTRE P45 40W	240V	P45	E27	FR	400	1000	100	ICT	7641650
LUSTRE P45 25W	125-130V	P45	E14	FR	255	1000	100	ICT	7622550
LUSTRE P45 25W	125-130V	P45	E27	FR	255	1000	100	ICT	7624950
LUSTRE P45 40W	125-130V	P45	E14	FR	480	1000	100	ICT	7623250
LUSTRE P45 40W	125-130V	P45	E27	FR	480	1000	100	ICT	7625650
LUSTRE P45 60W	125-130V	P45	E27	FR	725	1000	100	ICT	7626350

Standard Lustre (P-shape)

Incandescent



A55 White (A-shape)

Incandescent



A55 White E27



Standard light

Applications

- Living and dining rooms
- Hotels
- Restaurants
- Bedrooms
- Halls

Why choose?

- Conventional pear-shaped incandescent lamps

Technical features

- Gas-filled (25W and above) lamps with a modern white coating

A55 White (A-shape)

Incandescent

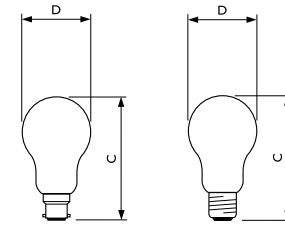

B22

E27

Dimensions in mm	C	D
A55 E27	96	55
A55 B22	93	55

Preferred selection

Product ID	Lamp Voltage (V)	Bulb Shape	Lamp Base	Bulb Finish	Light Output (Lm)	Lifetime (hrs)	Packaging Configuration (Pcs)	Packaging Type	Order Code
A55 White 40W	240V	A55	B22	White	385	1000	120	Carton	8711500 38260384
A55 White 40W	240V	A55	E27	White	385	1000	120	Carton	38265884
A55 White 60W	240V	A55	B22	White	680	1000	120	Carton	38261084
A55 White 60W	240V	A55	E27	White	680	1000	120	Carton	38266584
A55 White 75W	240V	A55	B22	White	895	1000	120	Carton	38262784
A55 White 75W	240V	A55	E27	White	895	1000	120	Carton	38267284
A55 White 100W	240V	A55	B22	White	1300	1000	120	Carton	38263484
A55 White 100W	240V	A55	E27	White	1300	1000	120	Carton	38268984
A55 White 40W	230V	A55	B22	White	395	1000	120	Carton	38269684
A55 White 40W	230V	A55	E27	White	395	1000	120	Carton	38272684
A55 White 60W	230V	A55	B22	White	690	1000	120	Carton	38270284
A55 White 60W	230V	A55	E27	White	690	1000	120	Carton	38273384
A55 White 100W	230V	A55	B22	White	1310	1000	120	Carton	38271984
A55 White 100W	230V	A55	E27	White	1310	1000	120	Carton	38274084
A55 White 40W	125-130V	A55	B22	White	460	1000	120	Carton	38275784
A55 White 40W	125-130V	A55	E27	White	460	1000	120	Carton	38278884
A55 White 60W	125-130V	A55	B22	White	790	1000	120	Carton	38276484
A55 White 60W	125-130V	A55	E27	White	790	1000	120	Carton	38279584
A55 White 100W	125-130V	A55	B22	White	1530	1000	120	Carton	38277184
A55 White 100W	125-130V	A55	E27	White	1530	1000	120	Carton	38280184

Softone Globe (G-shape)

Incandescent



Softone Globe



Decorative, soft light

Applications

- Home use in living and dining rooms, halls and studies
- Hotel lounges, restaurants, bedrooms, foyers
- Clubs, social areas and public areas
- Shops and boutiques
- Other similar areas

Why choose?

- Gives a delicate, glare-free light in a subtle white colour
- Enhances colours in the home and adds a new dimension to interior decoration
- Creates a pleasant, relaxed atmosphere with a high degree of visual comfort

Technical features

- Bulb internally coated with an opal layer, creating a soft, diffused, glare free light
- Diffused light without harsh shadows

Softone Globe (G-shape)

Incandescent

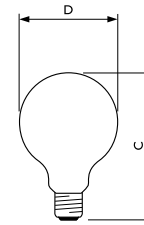

Softone Globe

Burning position



Universal

Dimensions in mm	C	D
Softone G80	124	80
Softone G95	146	95
Softone G120	171	122

Preferred selection

Product ID	Lamp Voltage (V)	Bulb Shape	Cap/ Base	Finish	Luminous Flux Lamp (Lm)	Avg Lifetime (hrs)	Packaging Configuration	Packaging Type	Order Code
Softone Globe 40W	230V	G95	E27	Soft White	390	1000	10	ICT	8711500 3454025
Softone Globe 60W	230V	G80	E27	Soft White	630	1000	10	ICT	3440325
Softone Globe 60W	230V	G95	E27	Soft White	630	1000	10	ICT	3455725
Softone Globe 100W	230V	G95	E27	Soft White	1200	1000	10	ICT	3484725
Softone Globe 100W	230V	G120	E27	Soft White	1200	1000	10	ICT	3464925
Softone Globe 150W	230V	G120	E27	Soft White	1750	1000	10	ICT	7387725

Deco Candle Swan-Neck

Incandescent



Swan-Neck Clear



A luxurious ambiance

Applications

- Suitable for a wide variety of decorative lighting solutions
- Home use in living and dining rooms, studies and halls
- Hotel lounges, restaurants, bedrooms, halls, conference rooms and foyers
- Clubs and social areas
- Ballrooms
- Shops and boutiques

Why choose?

- The clear types with their brilliant, visible filament add small points of brightness for an enriched lighting effect.
- The amber and frosted types give a softly diffused light for cosiness and comfort.

Technical features

- Special decorative flame-shaped bulb available with clear glass, with amber or with inside frosted glass

Deco Candle Swan-Neck

Incandescent

Dimensions in mm	C	D
Deco BxS35	114	35

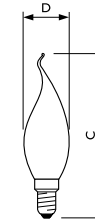

Swan-Neck

Universal

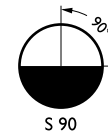

Preferred selection

Product ID	Lamp Voltage (V)	Bulb Shape	Cap/ Base	Finish	Luminous Flux Lamp (Lm)	Avg Lifetime (Lm)	Packaging Configuration	Packaging Type	Order Code
Deco Swan-Neck 25W	230V	BXS35	E14	clear	180	1000	20	ICT	8711500 17579338
Deco Swan-Neck 25W	230V	BXS35	E14	amber	170	1000	20	ICT	32919638
Deco Swan-Neck 25W	230V	BXS35	E14	frosted	180	1000	20	ICT	17534238
Deco Swan-Neck 40W	230V	BXS35	E14	clear	370	1000	20	ICT	17580938
Deco Swan-Neck 40W	230V	BXS35	E14	amber	360	1000	20	ICT	32919638
Deco Swan-Neck 40W	230V	BXS35	E14	frosted	370	1000	20	ICT	17535938

Party Standard (A-shape)

Incandescent Specialties



E27 Red



Party lights

Applications

- Suitable for a wide variety of decorative lighting solutions
- Home use in living and dining rooms, studies and halls
- Hotel lounges, restaurants, bedrooms, halls, conference rooms and foyers
- Clubs and social areas
- Ballrooms
- Shops and boutiques

Why choose?

- Environment-friendly due to ESC coating and cadmium-free lamp
- Energy savings thanks to much higher colour brilliance and lumen output than conventional coloured lamps with higher wattages
- Weather-resistant bulbs are perfectly suitable for outdoor use

Technical features

- Choice of attractive colours
- Superior quality thanks to the Electro Static Coated (ESC) internal coating (instead of the conventional wet-flushed inside paint process)

Party Standard (A-shape)

Incandescent Specialties

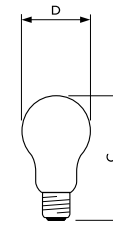

E27

Dimensions in mm	C	D
Deco Bx535	96	55

Preferred selection

Product ID	Lamp Voltage (V)	Bulb Shape	Cap/ Base	Finish	Avg Lifetime (hrs)	Packaging Configuration	Packaging Type	Order Code
								8711500
Party 15W	220-240V	A60	E27	Blue	1000	20	ICT	33901005
Party 15W	220-240V	A60	E27	Green	1000	20	ICT	33845705
Party 15W	220-240V	A60	E27	Orange	1000	20	ICT	33947805
Party 15W	220-240V	A60	E27	Red	1000	20	ICT	33912605
Party 15W	220-240V	A60	E27	Yellow	1000	20	ICT	33907205

Party Lustre (P-shape)

Incandescent Specialties



P45 Red



Party lights

Applications

- Outdoor: streets, facades, shopping centres, amusement parks, garden parties, carnivals, restaurants, bars, beaches, Christmas and other decorations
- Indoor: parties, special celebrations and decorative effects
- Multi-colour versions and printing of special graphics available on project basis

Why choose?

- Environment-friendly due to ESC coating and cadmium-free lamp
- Energy savings thanks to much higher colour brilliance and lumen output than conventional coloured lamps with higher wattages
- Weather-resistant bulbs are perfectly suitable for outdoor use

Technical features

- Choice of attractive colours
- Superior quality thanks to the Electro Static Coated (ESC) internal coating (instead of the conventional wet-flushed inside paint process)

Party Lustre (P-shape)

Incandescent Specialties

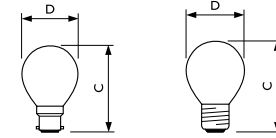

B22

E27

Dimensions in mm	C	D
Party P45 E27	76,5	45
Party P45 B22	76,5	45

Preferred selection

Product ID	Lamp Voltage (V)	Bulb Shape	Cap/ Base	Finish	Avg Lifetime (hrs)	Packaging Configuration	Packaging Type	Order Code
Party 15W	220-240V	P45	E27	Blue	1000	10X10F	1CT	8711500 17747650
Party 15W	220-240V	P45	E27	Green	1000	10X10F	1CT	32690450
Party 15W	220-240V	P45	E27	Orange	1000	10X10F	1CT	32692850
Party 15W	220-240V	P45	E27	Red	1000	10X10F	1CT	17743805
Party 15W	220-240V	P45	E27	Yellow	1000	10X10F	1CT	17745250
Party 15W	220-240V	P45	B22	Blue	1000	10X10F	1CT	17312650
Party 15W	220-240V	P45	B22	Green	1000	10X10F	1CT	17309650
Party 15W	220-240V	P45	B22	Orange	1000	10X10F	1CT	32686750
Party 15W	220-240V	P45	B22	Red	1000	10X10F	1CT	17306550
Party 15W	220-240V	P45	B22	Yellow	1000	10X10F	1CT	17315750



LINEAR S14s T30 WH



Soft diffused light

Applications

- Aquariums
- Pictures
- Mirrors
- Kitchen cabinets
- Other similar objects

Why choose?

- White-enamelled versions provide softly diffused lighting
- Specially positioned lamp bases allowing installation in continuous strips of light

Technical features

- White-enamelled finish
- Slender shape and high luminous intensity

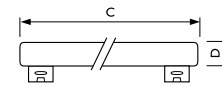

Philinea

Dimensions in mm	C	D
Philinea 35W	300	30
Philinea 60W	500	30
Philinea 120W	1000	30

Preferred selection

Product ID	Lamp Voltage (V)	Bulb Shape	Cap/ Base	Finish	Luminous Flux Lamp (Lm)	Avg Lifetime (hrs)	Packaging Configuration	Packaging Type	Order Code
Philinea 35W	240V	T30	S14s	White	270	1000	25	ICT	8711500 5690040
Philinea 35W	125-130V	T30	S14s	White	270	1000	25	ICT	13786940
Philinea 60W	230V	T30	S14s	White	420	1000	10	ICT	1356925
Philinea 60W	240V	T30	S14s	White	420	1000	25	ICT	5693140
Philinea 60W	125-130V	T30	S14s	White	420	1000	25	ICT	13788340
Philinea 120W	230V	T30	S14s	White	840	1000	16	ICT	1977643

PAR38

Incandescent Reflector



PAR38 E27 FLOOD



Spot lighting

Applications

- Can be used indoors and outdoors, or wherever blown-bulb reflector lamps would be too vulnerable
- Indoors: shops, window displays, homes, hotels, restaurants, theatres, museums, exhibitions and buildings
- Outdoors: floodlighting, advertising signs, buildings, statues, podiums, sports grounds, parks and gardens
- Can be installed outdoors without any protection, provided they are used in a watertight lampholder

Why choose?

- Saves 20% energy compared to conventional lamps while providing the same amount of light

Technical Features

- Spot versions have a stippled front reflector producing a narrow, homogeneous beam
- Flood versions have a front refractor composed of prismatic elements
- PAR38 lamps have a lifetime of 2000 hrs

PAR38

Incandescent Reflector

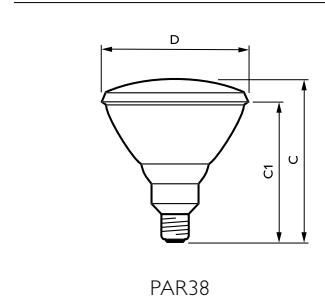

Dimensions in mm	C	C1	D
	max.	max.	max.
PAR38	135	123	121

Preferred selection

Product ID	Lamp Voltage (V)	Beam Description	Beam Angle (degrees)	Bulb shape	Cap/ Base	Luminous Intensity (cd)	Avg Lifetime (hrs)	Packaging Type	Order Code
PAR38 80W	230V	Spot	12D	PAR38	E27	4700	2000	1CT	8711500 60037092
PAR38 80W	240V	Spot	12D	PAR38	E27	4700	2000	1CT	01857197
PAR38 80W	230V	Flood	30D	PAR38	E27	1800	2000	1CT	90003620
PAR38 80W	240V	Flood	30D	PAR38	E27	1800	2000	1CT	01856497
PAR38 120W	220-240V	Spot	12D	PAR38	E27	8200	2000	1CT	60038792
PAR38 120W	240V	Spot	12D	PAR38	E27	8200	2000	1CT	02136697
PAR38 120W	220-240V	Flood	30D	PAR38	E27	3100	2000	1CT	60041792
PAR38 120W	240V	Flood	30D	PAR38	E27	3100	2000	1CT	02135997

PAR38 Coloured

Incandescent Reflector



PAR38 Red



Coloured light

Applications

- Parks, public and private gardens
- Festive illumination
- Restaurants, bars, dance halls, discotheques
- Show-window displays, fountains and 'Son et Lumi' spectacles
- Can be installed outdoors without any protection, provided they are used in a watertight lampholder
- For outdoor use, a heat-resistant rubber ring must be fitted between the lamp and the lampholder

Why choose?

- Gives striking decorative effects, both indoors and outdoors
- 20% lower power consumption compared with conventional coloured PAR lamps

Technical Features

- Weatherproof coloured coating on the refractor face in a choice of colours
- Flood beam width

PAR38 Coloured

Incandescent Reflector

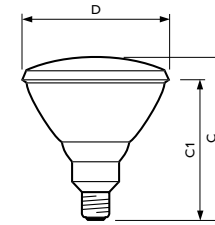

PAR38 Coloured

Dimensions in mm	C	CI	D
	max.	max.	max.
PAR38 Coloured	135	123	121

Preferred selection

Product ID	Lamp Voltage (V)	Bulb Shape	Cap/ Base	Finish	Avg Lifetime (hrs)	Packaging Type	Order Code
							8711500
PAR38 Coloured	230V	PAR38	E27	Blue	2000	ICT	33994220
PAR38 Coloured	240V	PAR38	E27	Blue	2000	ICT	04508997
PAR38 Coloured	230V	PAR38	E27	Yellow	2000	ICT	33996620
PAR38 Coloured	240V	PAR38	E27	Yellow	2000	ICT	04509697
PAR38 Coloured	230V	PAR38	E27	Green	2000	ICT	33998020
PAR38 Coloured	240V	PAR38	E27	Green	2000	ICT	04510297
PAR38 Coloured	230V	PAR38	E27	Red	2000	ICT	34000920
PAR38 Coloured	240V	PAR38	E27	Red	2000	ICT	04511997

Reflector R50

Incandescent Reflector



Reflector R50



Brighter light

Applications

- All the benefits of high-performance, high-efficiency spotlighting, simply by replacing conventional reflector lamps with ring mirror lamps of the same size and wattage
- Display lighting in shops, hotels, restaurants and homes

Why choose?

- Centre-beam intensities up to 100% higher than with conventional reflector lamps

Technical Features

- Optic gives double reflection of part of the light emitted by the filament
- Beam spread and luminous intensity make these lamps especially suitable wherever space is limited and in small luminaires
- Direct replacement for conventional reflector lamps of all kinds
- Easy fitting and removal thanks to tapered profile

Reflector R50

Incandescent Reflector

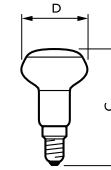

NR50

Dimensions in mm	C	D
	max.	max.
NR50	85	50

Preferred selection

Product ID	Lamp Wattage (W)	Lamp Voltage (V)	Cap/ Base	Bulb Shape	Beam Angle (degrees)	Finish	Luminous Intensity (cd)	Avg Lifetime (hrs)	Operating position	Packaging Type	Order Code
Reflector R50	25W	230V	E14	NR50	30D	Frosted	210	1000	any	ICT	8711500
Reflector R50	40W	125-130V	E14	NR50	30D	Frosted	400	1000	any	ICT	14985578
Reflector R50	40W	230V	E14	NR50	30D	Frosted	400	1000	any	ICT	05415978
Reflector R50	40W	240V	E14	NR50	30D	Frosted	400	1000	any	ICT	37986378

Reflector R63

Incandescent Reflector



Reflector R63



Narrow light beams

Applications

- Display lighting in shops, hotels, restaurants and homes

Why choose?

- Centre-beam intensities up to 100% higher than with conventional reflector lamps

Technical Features

- Optic gives double reflection of part of the light emitted by the filament
- Beam spread and luminous intensity make these lamps especially suitable wherever space is limited and in small luminaires
- Direct replacement for conventional reflector lamps of all kinds

Product Description

- Reflector lamps based on advanced spotlighting technology

Reflector R63

Incandescent Reflector

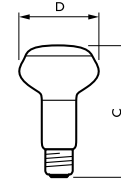

Reflector R63

Dimensions in mm	C	D
	max.	max.
NR63	103	63

Preferred selection

Product ID	Lamp Wattage (W)	Lamp Voltage (V)	Cap/ Base	Bulb Shape	Beam Angle (degrees)	Finish	Luminous Intensity (cd)	Avg Lifetime (hrs)	Operating Position	Packaging Type	Order Code
Reflector R63	25W	230V	E27	NR63	30D	Frosted	230	1000	any	ICT	8711500 04356678
Reflector R63	40W	230V	E27	NR63	30D	Frosted	420	1000	any	ICT	04360378
Reflector R63	40W	240V	E27	NR63	30D	Frosted	420	1000	any	ICT	04361078
Reflector R63	60W	125-130V	E27	NR63	30D	Frosted	750	1000	any	ICT	04365878
Reflector R63	60W	230V	E27	NR63	30D	Frosted	750	1000	any	ICT	04366578
Reflector R63	60W	240V	E27	NR63	30D	Frosted	750	1000	any	ICT	37988778

Reflector R80/E80

Incandescent Reflector



Reflector E80



Lighting effects

Applications

- Homes, shops, shop windows and displays, restaurants, hotels, exhibitions, bars and night clubs

Why choose?

- Beam spread and luminous intensity make these lamps especially suitable wherever space is limited and in small luminaires

Technical Features

- Blown glass bulb with frosted front
- Wide choice of diameters and wattages
- Lamp is designed to achieve brilliant indoor lighting effects

Product Description

- Normal incandescent lamps with an internal ring-shaped parabolic aluminium mirror behind the filament

Reflector R80/E80

Incandescent Reflector

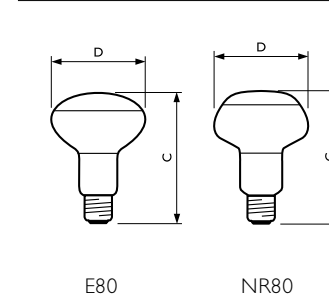

Dimensions in mm	C	D
	max.	max.
E80	113	80
NR80	115	80

Preferred selection

Product ID	Lamp Wattage (W)	Lamp Voltage (V)	Cap/ Base	Bulb Shape	Beam Angle (degrees)	Finish	Luminous Intensity (cd)	Avg Lifetime (hrs)	Operating Position	Packaging Type	Order Code
Reflector E80											
Reflector E80	40W	230V	E27	E80	50D	Frosted	370	1000	any	ICT	02860078
Reflector E80	60W	125-130V	E27	E80	80D	Frosted	270	1000	any	ICT	04654378
Reflector E80	60W	230V	E27	E80	50D	Frosted	580	1000	any	ICT	02861778
Reflector E80	60W	230V	E27	E80	80D	Frosted	270	1000	any	ICT	01245678
Reflector E80	60W	240V	E27	E80	80D	Frosted	270	1000	any	ICT	37990078
Reflector E80	75W	230V	E27	E80	50D	Frosted	770	1000	any	ICT	02863140
Reflector E80	75W	230V	E27	E80	80D	Frosted	360	1000	any	ICT	01247078
Reflector E80	75W	240V	E27	E80	80D	Frosted	360	1000	any	ICT	37991778
Reflector E80	75W	240V	E27	E80	80D	Frosted	360	1000	any	ICT	05378740
Reflector E80	100W	125-130V	E27	E80	80D	Frosted	530	1000	any	ICT	04659878
Reflector E80	100W	125-130V	E27	E80	80D	Frosted	530	1000	any	ICT	04659840
Reflector E80	100W	230V	E27	E80	50D	Frosted	1050	1000	any	ICT	02865578
Reflector E80	100W	230V	E27	E80	80D	Frosted	530	1000	any	ICT	01250078
Reflector E80	100W	240V	E27	E80	80D	Frosted	530	1000	any	ICT	37992478

Reflector R80

Reflector R80	60W	230V	E27	NR80	25D	Frosted	1000	1000	any	ICT	06581078
Reflector R80	60W	240V	E27	NR80	25D	Frosted	1000	1000	any	ICT	37983278
Reflector R80	75W	230V	E27	NR80	25D	Frosted	1600	1000	any	ICT	06401178
Reflector R80	75W	240V	E27	NR80	25D	Frosted	1600	1000	any	ICT	37984978
Reflector R80	100W	230V	E27	NR80	25D	Frosted	2000	1000	any	ICT	06404278
Reflector R80	100W	240V	E27	NR80	25D	Frosted	2000	1000	any	ICT	37985678

Reflector Colours

Incandescent Reflector



NR80 Green



Concentrated coloured beams

Applications

- Homes children's bedrooms and in-house bars
- Social areas, bars, night clubs, dance halls, theatres
- Show windows

Why choose?

- 25% more light in the centre of the beam (NR50 and NR63 versions) than standard coloured reflector lamps
- NR50 and NR63 versions are small lamps producing low illuminance levels for subdued lighting

Technical Features

- More concentrated beam with less stray light, providing a high degree of visual comfort
- Significantly improved beam light distribution, with no black spots
- Modern appearance with distinctive flatter-top shape and recessed neck
- Produced with cadmium-free lacquer

Reflector Colours

Incandescent Reflector

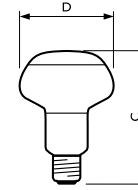

NR80 Colours

Dimensions in mm	C	D
	max.	max.
NR80 Colours	114	80

Preferred selection

Product ID	Lamp Wattage (W)	Lamp Voltage (V)	Cap/ Base	Bulb Shape	Beam Angle (degrees)	Finish	Luminous Intensity (cd)	Avg Lifetime (hrs)	Operating Position	Packaging Type	Order Code
Reflector Colours	60W	230V	E27	NR80	30D	Clear-Green	270	1000	any	ICT	8711500
Reflector Colours	60W	230V	E27	NR80	30D	Clear-Red	100	1000	any	ICT	06654115
Reflector Colours	60W	230V	E27	NR80	30D	Clear-Yellow	450	1000	any	ICT	06655815
Reflector Colours	60W	230V	E27	NR80	30D	Clear-Blue	180	1000	any	ICT	06652715

Softone T55

Comfort



E27 Softone



Visual comfort

Applications

- Home use in living and dining rooms, halls and studies
- Offices
- Hotel lounges, restaurants, bedrooms, halls, conference rooms and foyers
- Clubs, social areas and public accommodation
- Shops and boutiques
- Other similar areas

Why choose?

- Enhances colours in the home and adds a new dimension to interior decoration.
- Creates a pleasant, relaxed atmosphere with a high degree of visual comfort.

Technical Features

- T-shaped gas-filled lamps with a modern appearance.
- Gives a delicate, glare-free light in a subtle white or pastel colour

Softone T55

Comfort

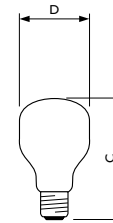

Softone T55

Dimensions in mm	C	D
	max.	nom.
Softone 75W E27 230V T55 WH I CT	95	55

Preferred selection

product ID	Lamp Voltage (V)	bulb Shape	Cap/base	Luminous Flux (lm)	Average Lifetime (hrs)	Packaging Type	Order Code
Softone 40W White	230V	T55	B22	370	1000 hrs	ICT	366375 84
Softone 60W Citron	230V	T55	B22	650	1000 hrs	ICT	366771 85
Softone 60W White	230V	T55	B22	630	1000 hrs	ICT	366405 84
Softone 75W White	230V	T55	B22	840	1000 hrs	ICT	366443 84
Softone 100W White	230V	T55	B22	1200	1000 hrs	ICT	366467 84
Softone 25W White	230V	T55	E27	165	1000 hrs	ICT	366504 86
Softone 40W Apricot	230V	T55	E27	345	1000 hrs	ICT	366535 85
Softone 40W Terracotta	230V	T55	E27	330	1000 hrs	ICT	366818 86
Softone 40W White	230V	T55	E27	370	1000 hrs	ICT	366306 84
Softone 60W Apricot	230V	T55	E27	620	1000 hrs	ICT	366603 84
Softone 60W Azur	230V	T55	E27	550	1000 hrs	ICT	366641 85
Softone 60W Citron	230V	T55	E27	650	1000 hrs	ICT	366634 84
Softone 60W Terracotta	230V	T55	E27	530	1000 hrs	ICT	366849 84
Softone 60W White	230V	T55	E27	630	1000 hrs	ICT	366221 84
Softone 75W White	230V	T55	E27	840	1000 hrs	ICT	366344 86
Softone 100W White	230V	T55	E27	1200	1000 hrs	ICT	366252 84



Compact High Intensity Discharge Lamps



MASTER Colour CDM-T

Quality



CDM-T 70W G12



High quality light

Applications

- For use in shops and shop windows, offices and public buildings
- Decorative outdoor: floodlighting and pedestrian areas

Why choose?

- High lamp efficacy for low operating costs and low heat output
- Very high quality of light
- Stable light colour over lifetime
- Long lifetime: 12000 hrs

Technical Features

- Range of single-ended, compact, high-efficiency, discharge lamps with a stable colour over lifetime and a crisp, sparkling light
- Warm or cool white colour impression
- Colour rendering good to excellent
- Allows small-size luminaires designs that give high beam intensities

MASTER Colour CDM-T

Quality

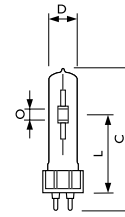

CDM-T

Dimensions in mm	C	D	L	O
	max.	max.	nom.	nom.
CDM-T 35W/830	103	20	56	5
CDM-T 70W/830	103	20	56	7
CDM-T 70W/942	103	20	56	6
CDM-T 150W/830	110	20	56	9
CDM-T 150W/942	110	20	56	8

Preferred selection

Product ID	Cap/ Base	Packing Configuration	Luminous Flux Lamp EM (lm)	Colour Temperature (K)	Operating Position	Colour Rendering Index (R _a)	Order Code
MASTER Colour CDM-T 35W/830 G12	G12	12	3300	3000	ANY	81	19697215
MASTER Colour CDM-T 70W/830 G12	G12	12	6600	3000	ANY	81	19699615
MASTER Colour CDM-T 70W/942 G12	G12	12	6600	4200	ANY	92	19927015
MASTER Colour CDM-T 150W/830 G12	G12	12	14000	3000	ANY	85	19780115
MASTER Colour CDM-T 150W/942 G12	G12	12	12700	4200	ANY	96	20005115

Product ID	Lamp Voltage (V)	Dimmable	Lamp Current EM (A)	Lamp Wattage EM (W)	Recommended ballast	Net weight per piece (g)	Ignition Supply min. (V)
MASTER Colour CDM-T 35W/830 G12	88	No	0.53	38	HID-PC035/...	27	198
MASTER Colour CDM-T 70W/830 G12	88	No	0.98	71	HID-PV070/...	29	198
MASTER Colour CDM-T 70W/942 G12	88	No	0.98	72	HID-PC070/...	29	198
MASTER Colour CDM-T 150W/830 G12	96	No	1.8	147	HID-PC150/...	33	198
MASTER Colour CDM-T 150W/942 G12	90	No	1.9	145	HID-PC150/...	33	198

Product ID	Ignition Time max. (sec.)	Colour Designation	Bulb Finish	Luminous Efficacy Lamp EM (lm/W)	Pinch Temp. max. (°C)
MASTER Colour CDM-T 35W/830 G12	30	Warm White	Clear	87	350
MASTER Colour CDM-T 70W/830 G12	30	Warm White	Clear	93	350
MASTER Colour CDM-T 70W/942 G12	30	Cool White	Clear	92	350
MASTER Colour CDM-T 150W/830 G12	30	Warm White	Clear	95	350
MASTER Colour CDM-T 150W/942 G12	30	Cool White	Clear	88	350

MASTER Colour CDM-TD

Colour stability



CDM-TD 70W



Colour stability

Applications

- For use in shops and shop windows, offices and public buildings
- Decorative outdoor: floodlighting of facades, statues and monuments

Why choose?

- Light colour that remains stable over lifetime
- Very high quality of light for a natural light effect
- Significant reduced costs of lighting ownership
- Long lifetime: 16000 hrs

Technical Features

- Range of double-ended, compact, high-efficiency, discharge lamps with a stable colour over lifetime and a crisp, sparkling light
- Warm or cool white colour impression
- Colour rendering good to excellent
- Retrofit in double-ended luminaires for quartz metal halide lamps (MHN/W-TD), thereby allowing to reduce operating costs and improve colour quality
- Burning position horizontal +/-45°

MASTER Colour CDM-TD

Colour stability

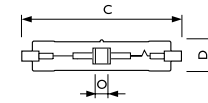

CDM-TD

Dimensions in mm	C	D	O
	max.	max.	nom.
CDM-TD 70W/830	119,63	22	8
CDM-TD 70W/942	119,63	22	6,85
CDM-TD 150W	137,43	25	10

Preferred selection

Product ID	Cap/ Base	Packing Configuration	Luminous Flux Lamp EM (lm)	Colour Temperature (K)	Operating Position	Colour Rendering Index (R _a)	Order Code
MASTER Colour CDM-TD 70W/830	RX7s	12	6500	3000	P45	82	19782515
MASTER Colour CDM-TD 70W/942	RX7s	12	6000	4200	P45	92	20002015
MASTER Colour CDM-TD 150W/830	RX7s	12	13250	3000	P45	88	19784915
MASTER Colour CDM-TD 150W/942	RX7s	12	14200	4200	P45	96	20025915

Product ID	Lamp Voltage (V)	Dimmable	Lamp Current EM (A)	Lamp Wattage EM (W)	Recommended Ballast	Net Weight per piece (g)	Ignition Supply Voltage min. (V)
MASTER Colour CDM-TD 70W/830	92	No	0,97	71	HID-PV 070/...	21	198
MASTER Colour CDM-TD 70W/942	89	No	0,99	71	HID-PV 070/...	21	198
MASTER Colour CDM-TD 150W/830	96	No	1,8	145	HID-PV 150/...	30	198
MASTER Colour CDM-TD 150W/942	100	No	1,82	149	HID-PV 150/...	30	198

Product ID	Ignition Time max. (sec.)	Colour Designation Lamp EM (lm/W)	Bulb Finish	Luminous Efficacy	Pinch Temperature max. (°C)
MASTER Colour CDM-TD 70W/830	30	Warm White	Clear	78	280
MASTER Colour CDM-TD 70W/942	30	Cool White	Clear	72	280
MASTER Colour CDM-TD 150W/830	30	Warm White	Clear	78	300
MASTER Colour CDM-TD 150W/942	30	Cool White	Clear	84	300

MHN/W-TD

Low Wattage Metal Halide



MHN-TD RX7s



Good colour quality

Applications

- For use in indoors - accent lighting, general lighting in downlighters, e.g. in shops and malls
- Downlighters, uplighters and wall-washers, e.g. in shops and malls
- Outdoors - floodlighting monuments, facades and billboards

Why choose?

- All types are UV-Block for reduced health and fading risks

Technical Features

- Double-ended quartz Metal halide discharge lamp
- Available in 3 colours: warm white (3000K), neutral white (4200K) and cool white (5200K), with good colour quality
- No UV output due to UV-block quartz of outer bulb
- Burning position horizontal +/-45°

MHN/W-TD

Low Wattage Metal Halide

Dimensions in mm	A	C	D	L	O
	max.	max.	max.	nom.	nom.
MHN/W 70W	117.6	119.63	21	57.1	7
MHN/W 150W	135.4	137.43	24	66	18
MHN/W 250W	135.4	161.6	27.5	69.5	27

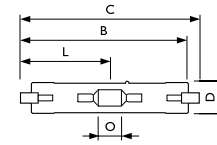

70+150W

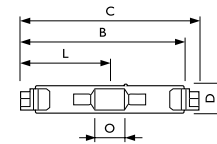

250W

Preferred selection

Product ID	Cap/ Base	Packing Configuration	Luminous Flux Lamp Electronic EM (lm)	Colour Temperature (K)	Operating Position	Order Code
MHW-TD 70W/730 RX7s ICT	RX7s	12	6200	3000	P45	20271015
MHW-TD 70W/842 RX7s ICT	RX7s	12	5700	4200	P45	73398615
MHW-TD 150W/730 RX7s ICT	RX7s	12	13800	3000	P45	20269715
MHN-TD 150W/842 RX7s ICT	RX7s	12	12900	4200	P45	73399315
MHN-TD 150W/852 RX7s ICT	RX7s	12	11000	5200	P45	20915315
MHN-TD 250W/842 FC2 ICT	FC2	12	20000	4200	P45	73400615

Product ID	Colour Rendering Index (R _a)	Lamp Voltage (V)	Bulb Temperature max. (°C)	Lamp Current Run-up max. (A)	Dimmable	Lamp Current EM (A)
MHW-TD 70W/730 RX7s ICT	75	90	500	1.35	No	1
MHW-TD 70W/842 RX7s ICT	80	90	500	1.35	No	1
MHW-TD 150W/730 RX7s ICT	80	96	650	2.4	No	1.8
MHN-TD 150W/842 RX7s ICT	85	98	650	2.4	No	1.8
MHN-TD 150W/852 RX7s ICT	85	98	650	2.4	No	1.8
MHN-TD 250W/842 FC2 ICT	85	100	650	4.5	No	3

Product ID	Lamp Wattage EM (W)	Recommended Ballast	Ignition Peak Voltage max. (V)	Colour Designation
MHW-TD 70W/730 RX7s ICT	75	HID-PV 070/...	5000	Warm White
MHW-TD 70W/842 RX7s ICT	75	HID-PV 070/...	5000	Neutral White
MHW-TD 150W/730 RX7s ICT	150	HID-PV 150/...	5000	Warm White
MHN-TD 150W/842 RX7s ICT	150	HID-PV 150/...	5000	Neutral White
MHN-TD 150W/852 RX7s ICT	150	BSN150L30	5000	Cool White
MHN-TD 250W/842 FC2 ICT	252	BSN250L33	3500	Neutral White

Product ID	Bulb Finish	Luminous Efficacy Lamp Electronic (lm/W)	Nett Weight Product (g)
MHW-TD 70W/730 RX7s ICT	Clear	83	22
MHW-TD 70W/842 RX7s ICT	Clear	76	22
MHW-TD 150W/730 RX7s ICT	Clear	92	30
MHN-TD 150W/842 RX7s ICT	Clear	86	30
MHN-TD 150W/852 RX7s ICT	Clear	73	30
MHN-TD 250W/842 FC2 ICT	Clear	80	61





High Intensity Discharge Lamps



MASTER HPI-T Plus

MH/HPI Metal Halide



HPI-T



Low maintenance costs

Applications

- Sports lighting, floodlighting of buildings and monuments, area lighting e.g. harbours and building sites, canopy lighting e.g. petrol stations, horticultural lighting

Why choose?

- High safety and comfort level, maintained over life
- Minimal maintenance cost
- Initial investment saving options with “Plus”-concept

Technical Features

- Quartz metal halide lamps with clear outer bulb
- Clear tubular outer bulb
- Unique 3-band technology resulting in high luminous efficacy, both initially and over long lifetime
- Renders a natural white colour appearance and good colour stability
- HPI-T Plus lamps require a protective front glass
- Can be run on HPI-gear as well as on SON-gear (“Plus”-concept). The results in both light output and colour temperature are different

MASTER HPI-T Plus

MH/HPI Metal Halide

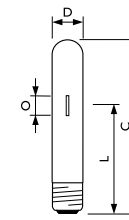

HPI-T

Dimensions in mm	C	D	L	O
	max.	max.	nom.	nom.
HPI-T Plus 250W	257	47	158	29
HPI-T Plus 400W	286	47	172	40

Preferred selection

Product ID	Cap/ Base	Packing Configuration	Colour Rendering Index (R _a)	Colour Temp. (K)	Luminous Flux Lamp EM (lm)	Operating Position	Order Code
MASTER HPI-T Plus 250W/645 E40	E40	12	65	4500	19000	P20	17989015
MASTER HPI-T Plus 400W/645 E40	E40	12	65	4500	30000	P20	17990615

Product ID	Mains Voltage (V)	Lamp Voltage (V)	Bulb Finish	Lamp Current EM (A)	Luminous Efficacy Lamp EM (lm/W)	Lamp Wattage EM (W)
MASTER HPI-T Plus 250W/645 E40	198	128	Clear	2.15	76	250
MASTER HPI-T Plus 400W/645 E40	198	128	Clear	2.15	76	250

Product ID	Recommended Ballast	Net weight per piece (g)	Ignition Supply Coordinate min. (V)	Colour Designation
MASTER HPI-T Plus 250W/645 E40	BHL250L307	178	198	Cool White
MASTER HPI-T Plus 400W/645 E40	BHL400L307	178	198	Cool White

MASTER HPI Plus (Daylight)

Comfort



HPI



Safety and comfort

Applications

- High bay lighting, e.g. industrial workshops, exhibition halls, supermarkets, shopping malls, DIY stores, churches, airports and train stations

Why choose?

- High safety and comfort level, maintained over life
- Minimal maintenance cost
- Initial investment saving options with “Plus”-concept and “S” and “P”-types
- Adjustable atmosphere creation by using appropriate colour temperature

Technical Features

- Ovoid, internally white coated outer bulb
- Unique 3-band technology resulting in high luminous efficacy, both initially and over long lifetime
- Available in cool white and daylight
- Colour appearance demonstrating good colour stability
- HPI Plus BU-P and BUS-P suitable for use in open luminaires
- For other HPI Plus lamps a protective front glass is required

MASTER HPI Plus (Daylight)

Comfort

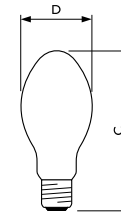

HPI

Dimensions in mm	C	D
	max.	max.
HPI BU/BU-P 250W	262	91
HPI BU/BU-P 400W	284	122
HPI BUS/BUS-P 400W	290	122

Preferred selection

Product ID	Cap/ Base	Packing Configuration	Colour Rendering Index (R _a)	Colour Temp. (K)	Luminous Flux Lamp EM (lm)	Operating Position	Order Code
							8711500
MASTER HPI Plus 250W/743 BU E40	E40	12	69	4300	18000	H15	18114515
MASTER HPI Plus 250W/767 BU E40	E40	12	69	6700	18000	H15	20739515
MASTER HPI Plus 250W/743 BU-P E40	E40	12	69	4300	18000	H15	21147715
MASTER HPI Plus 400W/743 BU E40	E40	6	69	4300	32500	H15	18252410
MASTER HPI Plus 400W/767 BU E40	E40	6	69	6700	32500	H15	20737110
MASTER HPI Plus 400W/743 BU-P E40	E40	6	69	4300	32500	H15	21143910
MASTER HPI Plus 400W/743 BUS E40	E40	6	69	4300	32500	H15	18114110
MASTER HPI Plus 400W/743 BUS-P E40	E40	6	69	4300	32500	H15	21145310

Product ID	Mains Voltage (V)	Lamp Voltage (V)	Bulb Finish	Lamp Current EM (A)	Luminous Efficacy Lamp EM (lm/W)	Lamp Wattage EM
MASTER HPI Plus 250W/743 BU E40	198	128	Coated	2.2	72	253
MASTER HPI Plus 250W/767 BU E40	198	125	Coated	2.2	72	253
MASTER HPI Plus 250W/743 BU-P E40	198	128	Coated	2.2	72	253
MASTER HPI Plus 400W/743 BU E40	198	125	Coated	3.4	82	395
MASTER HPI Plus 400W/767 BU E40	198	125	Coated	3.4	82	395
MASTER HPI Plus 400W/743 BU-P E40	198	125	Coated	3.4	82	395
MASTER HPI Plus 400W/743 BUS E40	198	125	Coated	3.4	82	395
MASTER HPI Plus 400W/743 BUS-P E40	198	125	Coated	3.4	82	395

Product ID	Recommended Ballast	Net weight per piece (g)	Ignition Supply Voltage min. (V)	Colour Designation
MASTER HPI Plus 250W/743 BU E40	BHL250 L302 ITS	182	198	Cool White
MASTER HPI Plus 250W/767 BU E40	BHL250 L302 ITS	192	198	Daylight
MASTER HPI Plus 250W/743 BU-P E40	BHL250 L302 ITS	190	198	Cool White
MASTER HPI Plus 400W/743 BU E40	BHL400 L302 ITS	250	198	Cool White
MASTER HPI Plus 400W/767 BU E40	BHL400 L302 ITS	250	198	Daylight



SON E27



Energy efficiency

Applications

- For use in road and residential lighting
- Decorative floodlighting
- Commercial and industrial applications

Why choose?

- Energy efficiency
- SON Pro is a cost-efficient and reliable solution in High Pressure Sodium, offering good value for money

Technical Features

- Ovoid, internally white coated outer bulb
- Robust construction is vibration- and shock-resistant leading to a reliable life
- Dimming possible with dedicated gear
- Require a ballast and ignitor, except for SON 70W I lamps which have an internal ignitor

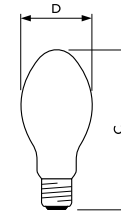

SON E27

Dimensions in mm	C	D
	max.	max.
SON 70W	156	71
SON 150W/250W	227	91
SON 400W	290	122

Preferred selection

Product ID	Ignitor kind	Cap/ Base	Packing Configuration	Colour Rendering Index (Ra)	Colour Temperature (K)	Luminous Flux Lamp EM (lm)	Operating Position	Order Code
SON 70W	E	E27	24	25	2000	5600	ANY	871 1500
SON 70W	I	E27	24	25	2000	5600	ANY	210 24130
SON 150W	E	E40	12	25	2000	14500	ANY	9284 806 00092
SON 250W	E	E40	12	25	2000	27000	ANY	210 28915
SON 400W	E	E40	12	25	2000	48000	ANY	210 38815
								210 32615

Product ID	Lamp Voltage (V)	Bulb Shape	Bulb Finish	Dimmable	Lamp Current EM (A)	Luminous Efficacy Lamp EM (lm/W)
SON 70W	90	B70	Coated	Yes	0.98	80
SON 70W	90	B70	Coated	Yes	0.98	80
SON 150W	100	BD90	Coated	Yes	1.8	99
SON 250W	100	BD90	Coated	Yes	3	108
SON 400W	105	BD120	Coated	Yes	4.45	120

Product ID	Lamp Wattage EM (W)	Recommended Ballast	Net weight per piece (g)	System Description	Luminance Average EM (cd/cm ²)	Ignition Supply Voltage min. (V)
SON 70W	70	BSN70L33 TS	52	External ignitor	6.6	198
SON 70W	70	BSN70L33 TS	57	Internal Ignitor	6.6	198
SON 150W	147	BSN150L33 TS	180	External ignitor	-	198
SON 250W	250	BSN250L33 TS	175	External ignitor	19	198
SON 400W	400	BSN400L33 TS	240	External ignitor	24	198

SON-T

Cost effectiveness



SON-T E40



Cost efficient

Applications

- For use in road and residential lighting
- Decorative floodlighting
- Commercial and industrial applications
- Recreational sports facilities Outdoor and Indoor

Why choose?

- Energy efficiency
- SON-T Pro is a cost-efficient and reliable solution in High Pressure Sodium, offering good value for money

Technical Features

- High Pressure Sodium lamp with clear outer bulb
- Clear tubular outer bulb
- Robust construction is vibration- and shock-resistant leading to a reliable life
- Dimming possible with dedicated gear

SON-T

Cost effectiveness

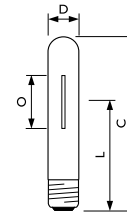

SON-T

Dimensions in mm	C	D	L	O
	max.	max.	nom.	nom.
SON-T 70W	156	37	102	42
SON-T 100W	210	46	132	44
SON-T 150W	211	47	132	61
SON-T 250W	257	47	158	70
SON-T 400W	283	47	175	87
SON-T 1000W	390	66	240	153

Preferred selection

Product ID	Ignitor Kind	Cap/ Base	Packing Configuration	Colour Rendering Index (Ra)	Colour Temperature (K)	Luminous Flux Lamp EM (lm)	Operating Position	Order Code
SON-T 70W	E	E27	12	25	2000	6000	ANY	210 42515
SON-T 100W	E	E40	12	25	2000	9000	ANY	9284 815 00091
SON-T 150W	E	E40	12	25	2000	15000	ANY	210 46315
SON-T 250W	E	E40	12	25	2000	28000	ANY	210 52415
SON-T 400W	E	E40	12	25	2000	48000	ANY	210 56215
SON-T 1000W	E	E40	4	25	2000	130000	ANY	210 60945

Product ID	Lamp Voltage (V)	Bulb Shape	Bulb Finish	Dimmable	Lamp. Current EM (A)	Luminous Efficacy Lamp EM (lm/W)
SON-T 70W	90	T31	Clear	Yes	0.98	86
SON-T 100W	100	T46	Clear	-	1.2	90
SON-T 150W	100	T46	Clear	Yes	1.8	100
SON-T 250W	100	T46	Clear	Yes	3	112
SON-T 400W	100	T46	Clear	Yes	4.6	120
SON-T 1000W	105	T65	Clear	Yes	10.6	130

Product ID	Lamp Wattage EM (W)	Recommended Ballast	Net weight per piece (g)	System Description	Luminance Average EM (cd/cm ²)
SON-T 70W	70	BSN70L33 TS	45	External ignitor	270
SON-T 100W	100	-	134	External ignitor	-
SON-T 150W	150	BSN150L33 TS	136	External ignitor	300
SON-T 250W	250	BSN250L33 TS	170	External ignitor	400
SON-T 400W	392	BSN400L33 TS	175	External ignitor	550
SON-T 1000W	1000	BSN1000L78	404	External ignitor	650

SON H

SON High Pressure Sodium



SONH



Energy savings

Applications

- For use in road and residential lighting
- Industrial lighting both indoor and outdoor
- Recreational sports facilities Outdoor and Indoor

Why choose?

- Superior technology results in a long and reliable lifetime, high lumen maintenance and a reliable ignition over lifetime
- High energy efficacy and absence of lead (Pb) makes this a sound environmental offer
- High luminous efficacy makes this the most energy efficient HPS lamp
- Direct upgrade, without gear change

Technical Features

- Ovoid, internally white coated outer bulb
- Ceramic discharge tube with Philips Integrated Antenna (PIA) for a long and reliable lifetime
- Robust construction with few welding points is highly vibration- and shock-resistant, further reducing early failures and extending lamp life
- Operates both on HPL gear

SON H

SON High Pressure Sodium

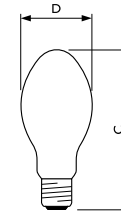

SON-H

Dimensions in mm	C	D
	max.	max.
SON-H 110W	169	71
SON-H 220W	227	91
SON-H 350W	290	122

Preferred selection

Product ID	Cap/ Base	Packing Configuration	Colour Rendering Index	Colour Temperature (K)	Luminous Flux Lamp EM (lm)	Operating Position	Order Code
SON H 110W	E27	24	25	2000	10400	ANY	20186730
SON H 220W	E40	12	25	2000	20000	ANY	18207415
SON H 350W	E40	12	25	2000	34000	ANY	18213515

Product ID	Lamp Voltage (V)	Bulb shape	Bulb finish	Dimmable	Lamp Current EM (A)	Luminous Efficacy Lamp EM (lm/W)
SON H 110W	117	B70	Coated	No	1.22	92
SON H 220W	120	BD90	Coated	No	2.2	91
SON H 350W	117	BD120	Coated	No	3.6	97

Product ID	Lamp Wattage EM (W)	Recommended Ballast	Net weight per piece (g)	Luminance Average EM (cd/cm ²)
SON H 110W	113	BHL125L202	60	-
SON H 220W	220	BHL250L202	170	15
SON H 350W	350	BHL350L202	236	18



HPL E40



Soft white light

Applications

- All outdoor applications, factories, transport sector and industrial area lighting

Why choose?

- Low initial costs (higher lifetime costs)

Product Features

- Standard High Pressure Mercury lamp
- Equipped with 1 electrode to ensure quick and reliable ignition
- Single-ended gas-filled glass bulb (HG-SG) with a quartz mercury vapour discharge tube
- Internally coated ovoid outer bulb, providing a cool, bluish white light with reasonable colour qualities

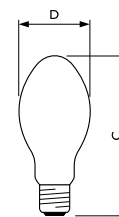

HPL-N

Dimensions in mm	C	D
	max.	max.
HPL-N 50W	129	55
HPL-N 80W	154	70
HPL-N 125W	172	75
HPL-N 250W	227	90
HPL-N 400W	289	121

Operational position



Universal

Preferred selection

Product ID	Cap/ Base	Packing Configuration	Colour Rendering Index (R _a)	Colour Temperature (K)	Luminous Flux Lamp EM (lm)	Operating Position	Order Code
HPL-N 50W/542	E27	24	49	4200	1800	ANY	9280 505 07396
HPL-N 80W/542	E27	24	48	4200	3700	ANY	9280 510 07396
HPL-N 125W/542	E27	24	46	4100	6200	ANY	9280 520 07396
HPL-N 250W/542	E40	12	45	4100	12700	ANY	9280 530 07496
HPL-N 400W/542	E40	6	45	3900	22000	ANY	9280 535 07496

Product ID	Lamp Voltage (V)	Bulb Finish	Lamp Current EM (A)	Luminous Efficacy Lamp EM (lm/W)	Lamp Wattage EM (W)	Soft Glass/ Hard Glass
HPL-N 50W/542	95	Coated	0.61	36	50	SG
HPL-N 80W/542	115	Coated	0.8	44.5	84	SG
HPL-N 125W/542	125	Coated	1.15	50	125	SG
HPL-N 250W/542	135	Coated	2.1	51	250	HG
HPL-N 400W/542	140	Coated	3.25	55	400	HG

Product ID	Recommended Ballast	Net weight per piece (g)	Colour Designation
HPL-N 50W/542	BHL50L202	45	Cool White
HPL-N 80W/542	BHL80L202	57	Cool White
HPL-N 125W/542	BHL125L202	63	Cool White
HPL-N 250W/542	BHL250L02	184	Cool White



ML E27



More efficient than incandescent

Applications

- Public outdoor lighting, car parks, workshops, garages and shops

Why choose?

- Direct retrofit for incandescent lamps
- Higher efficacy and lifetime than incandescent

Technical Features

- High-pressure mercury tube in series with a tungsten filament
- Runs on mains voltage without additional gear
- Combines a continuous spectrum from the incandescent source and a line spectrum from the high-pressure mercury source
- It is recommended to protect ML against water splashes
- ML lamps are not dimmable

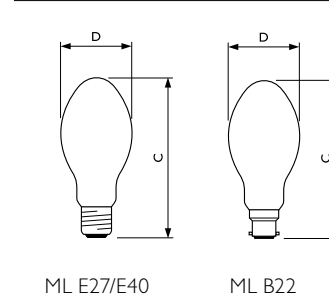

ML E27/E40

ML B22

Burning positions



ML 100 W ML
160 W

Burning positions

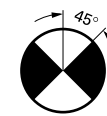

ML 250 W ML
500 W

Dimensions in mm	C	D
	max.	max.
160W B22	165	75
100W E27	154	70
160W E27	172	75
250W E27	216	90
250W E40	226	90
500W E40	289	120

Operational position



Universal

Preferred selection

Product ID	Lamp Base	Packaging Configuration	Soft Glass/ Hard glass	Colour Rendering Index (R _a)	Colour Temperature (K)	Luminous flux lamp EM (lm)	Order Code
ML100W	E27	24	SG	72	3300	1100	9280 900 57296
ML160W	B22	24	SG	65	3600	3150	9286 010 11401
ML160W	E27	24	SG	65	3600	3150	9286 010 08988
ML250W	E27	12	SG	65	3400	5400	9280 960 56898
ML250W	E40	12	HG	65	3400	5400	9280 962 57296
ML250W	E40	12	SG	65	3400	5400	9286 010 09288
ML500W	E40	6	HG	48	3700	13000	9280 970 57796

Product ID	Voltage	Bulb Finish	Lamp Current EM (A)	Luminous Efficacy lamp EM (Lm/W)	Net weight per piece (g)	Ignition Supply Voltage min. (V)
ML100W	220-230V	coated	0.46	10.5	52	180
ML160W	220-230V	coated	0.76	19	64	180
ML160W	220-230V	coated	0.76	19	61	180
ML250W	225-235V	coated	1.2	21	184	180
ML250W	220-230V	coated	1.2	21	184	180
ML250W	220-230V	coated	1.2	21	184	180
ML500W	220-230V	coated	2.3	26	230	180
ML500W	225-235V	coated	2.3	26	230	180



Starters



Lamp Control Gear

Starters for fluorescent lamps



S10-E



Definition

- Range of premium quality glow switch and electronic starters, used to ignite fluorescent lamps on electromagnetic control gear

Applications

- Starters are used in conventional electromagnetic fluorescent lamp systems using TLD (T8), TL (T12), TL mini, PLS and PLL lamps
- When replacing the fluorescent lamps it is recommended to also replace the starter
- For 220/240V~, 18W Single-application, Philips recommend S2 for optimal performance
- For 220/240V~, 13W Single-application, the S10 starter needs to be used
- S2 starters for ignition of low-voltage fluorescent TL lamps and serie/single application in high voltage for lower wattages (4-22W)

Lamp Control Gear

Starters for fluorescent lamps

Dimensions in mm	C	E
1. Starters S2/S10	max.	max.
2. Starters S2-E/S10-E/SIS 10	40	22

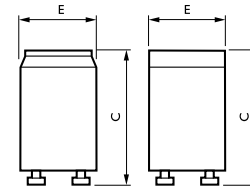

Starters S2/S10

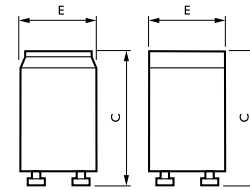

Starters S2-E/S10

Why choose?

Starters S2/S10

- More than 25% longer lamp life; lower maintenance costs compared with lower-quality, non-IEC-complaint starters (>10000 switches)
- Eco-friendly, recyclable concept (free of lead and radioactivity)
- Flame-retardant components and UV-resistant canister for additional safety and secure ignition
- Easy recognition & installation and replacement friendly

Starters S2-E/S10-E

- Lower cost of lighting ownership: -Electronic starters turn off lamps at end of life, which avoids irritation (no flickering), useless electricity consumption and fire risk / - Lamps last much longer thanks to a totally smooth, flickerfree and fast starting / - Longer starter service life compared to conventional starters (100000 switches)
- Eco-friendly, recyclable concept (free of lead and radioactivity)
- Flame-retardant components and UV-resistant canister for additional safety and secure ignition
- Easy recognition & installation and replacement friendly

Starters SiS 10

- Lower cost of lighting ownership: -SiS10 starter turns off lamps at end of life, which avoids irritation (no flickering), useless electricity consumption and fire risk / - Four times longer service life compared to conventional starters
- System is immediately ready for use again by simply pressing the red button following an interruption
- Contribution to a green environment (no radioactivity)
- Flame-retardant components and UV-resistant canister for additional safety and secure ignition



Technical data

Product ID	Circuit	Mains voltage Range V	Wattage Range W	Lamp Range
S2	single	110-130	4-22	4, 6, 8, 14-16, 15, 18, 20, 22W
S2	single	220-240	4, 6, 8, 15, 18, 22	4, 6, 8, 14-16, 15, 18, 20, 22W
S2	series	220-240	4-22	4, 6, 8, 14-16, 15, 18, 20, 22W
S10	single	220-240	4-65	4, 6, 8, 13, 14-16, 15, 16, 18, 20, 22, 23, 30, 32, 36, 38, 40, 58, 60, 65W
S2-E	single	110-130	18-22	18, 20, 22W
S2-E	series	220-240	18-22	18, 20, 22W
S10-E	single	220-240	18-75	18, 20, 22, 30, 32, 36, 38, 40, 58, 65W
SiS 10	single	220-240	30-65	30, 32, 36, 38, 40, 58, 65W
S12	single	220-240	115-140	115, 140W
S16	single	240	70, 75, 85, 100, 125	70, 75, 85, 100, 125W

Ordering and packing data

Product ID	Box packing quantity	Dimensions in cm			Weight Gross kg	Order Code
		L	B	H		
S2 blue	12x25	23.0	23.0	13.5	2.298	928390610103
	1000	40.0	30.0	19.3	7.735	928390610123
S10 blue	12x25	23.0	23.0	13.5	2.298	928392110103
	1000	40.0	30.0	19.3	7.735	928392110123
S2-E	20x25	23.0	23.0	22.5	4.900	926000192603
S10-E	20x25	23.0	23.0	22.5	4.800	926000192703
SiS 10	20x10	22.5	13.0	17.5	2.100	928391000020
S12	20x25	23.0	23.0	22.5	3.975	928391630303
S16	1000	40.0	30.0	18.8	7.500	928890930355