

# INSTALLER'S & OWNER'S MANUAL

*HVAC INSTALLER: PLEASE LEAVE MANUAL FOR HOMEOWNER*

# Ultra·Aire 90H



**P/N 4025700 • Serial No.** \_\_\_\_\_

The Ultra-Aire 90H dehumidifier performs multiple functions in a compact enclosure; high-capacity dehumidification, fresh air ventilation, and particulate filtration.

## **Dehumidification**

The highly efficient UA-90H dehumidifier utilizes refrigeration to cool the incoming air stream below its dew point. This cooled and drier air is used to pre-cool the incoming air stream resulting in increased overall efficiency. After the pre-cooling stage the processed air is reheated by passing through the condenser coil. The heat removed by the evaporator coil is returned to the air stream, resulting in an overall temperature increase from the incoming air.

## **Fresh Air Ventilation (optional)**

Fresh air may be ducted to the unit and regulated by a variety of controls in order to provide desired ventilation rates.

## **Air Filtration**

The UA-90H includes particulate filtration to improve the indoor air quality of your living/working space. MERV-11 media filter is standard.



Driven by performance. Powered by design.™

P.O. Box 8680 Madison, WI 53708 • TOLL-FREE 1-800-533-7533 • [www.thermastor.com](http://www.thermastor.com) • [sales@thermastor.com](mailto:sales@thermastor.com)

© 2007 Therma-Stor LLC • Manual P/N TS-325, 8/07

# TABLE OF CONTENTS

Introduction .....	1	4.9A Setting the Time .....	9
Features & Benefits .....	1	4.9B Ventilation Schedule .....	9
Safety Precautions .....	3	4.9C Automatic or Manual Mode .....	9
1. Intended Application .....	4	5. DEH 3000 Digital Control .....	10
2. Registrations .....	4	5.1. Specifications.....	10
3. Specifications .....	4	5.2. Installation .....	10
4 . Installation .....	4	5.2A Install Instructions .....	10
4.1 Installation Checklist .....	4	5.2B Wiring.....	10
4.1A Power Accessibility .....	4	5.2C Auxillary Relay Operation.....	11
4.1B Space .....	4	5.2D Dehumidifier Lockout.....	11
4.1C Low Voltage Wiring .....	4	5.2E Location .....	12
4.1D Back-Draft Damper .....	4	5.2F Testing.....	12
4.1E Support Structure and Suspension .....	4	5.3. Operation.....	13
4.2 Electrical Requirements .....	4	5.3A Display .....	13
4.3 Condensate Removal .....	5	5.3B Setting .....	13
4.3A Lifting Condensate .....	5	5.3C On/Off Setting .....	13
4.3B Condensate Pump Kit .....	5	5.3D Setting Clock Time .....	13
4.4 Ducting .....	5	5.3E Setting Relative Humidity Setpoint.....	13
4.4A Fresh Air/Supply Air .....	5	5.3F Fan Setting & Operation.....	14
4.4B Ducting for Fresh Air - Option .....	6	5.3G Damper Operation and Setting (Ventilation) .....	14
4.4C Installation in a Basement or Crawlspace .....	6	5.3H Intermittent/Programmed Ventilation .....	15
4.4D Installation in an Attic .....	7	5.3I Temperature Cutout Programming.....	16
4.4E Installation in a Structure with No Forced Air HVAC System .....	7	5.3J Default Settings .....	17
4.4F Ducting for High Efficiency Filtration .....	7	6. Control Package Diagram Sheet.....	14
4.5 Compressor Release and Noise Abatement.....	7	7. Maintenance .....	18
4.6 Controls .....	7	7.1 Standard Air Filter .....	18
4.6A Humidity/Fan Control Panel WITHOUT Fresh Air Ventilation or Damper .....	8	7.2 High Efficiency Air Filter .....	18
4.6B Humidity/Fan Control Panel WITH Fresh Air Ventilation and WITHOUT Damper .....	8	7.3 Optional Fresh Air Intake .....	18
4.6C Humidity/Fan Control Panel WITH Fresh Air Ventilation AND Damper .....	8	8. Wiring Diagrams .....	19
4.6D Ventilation Timer and Humidity Control WITH Fresh Air AND Motorized Damper .....	8	9. Optional Parts List .....	20
4.6E DEH 2000 Digital Controller WITH Fresh Air AND Damper .....	8	10. Service Parts List .....	21
4.6F DEH 2000 Digital Controller WITHOUT Fresh Air .....	8	11. Service .....	22
4.7 Humidity Control Adjustment .....	8	11.1 Technical Description .....	22
4.8 Fan/Filter Switch .....	8	11.2 Troubleshooting .....	22
4.9 Ventilation Timer .....	9	11.3 Refrigerant Charging .....	23
		11.4 Compressor/Capacitor Replacement .....	23
		11.5 Electric Ventilation Damper .....	23
		11.6 Condensate Pump Kit .....	23-29
		Warranty .....	30

## SAFETY PRECAUTIONS

Read the installation, operation and maintenance instructions carefully before installing and operating this device. Proper adherence to these instructions is essential to obtain maximum benefit from your Ultra-Aire 90H indoor air quality system.

### **READ AND SAVE THESE INSTRUCTIONS**

- The device is designed to be installed INDOORS IN A SPACE THAT IS PROTECTED FROM RAIN AND FLOODING.
- Install the unit with space to access the front panel for maintenance and service. DO NOT INSTALL UNIT WITH THE FRONT PANEL INACCESSIBLE.
- Avoid directing the discharge air at people, or over the water in pool areas.
- If used near a pool or spa; be certain there is NO chance the unit could fall into the water, splashed and that it is plugged into a GFCI GROUND FAULT CIRCUIT INTERRUPT OUTLET.
- DO NOT use the device as a bench or table.
- DO NOT place the device directly on structural members.
- A drain pan MUST be placed under the unit if installed above a living area or above an area where water leakage could cause damage.

## 1. Intended Application for Ultra-Aire 90H

For the ideal installation, draw air from the central part of the home and return it to isolated areas of the home like the bedrooms, den, utility room, or family room. The ductwork of the existing heating system can be used to supply air to the home.

## 2. Registrations

The UA-90H conforms to UL STD 474 and CSA Standard C22.2 No.92.

## 3. Specifications

Model:	Ultra-Aire 90H
Electrical:	110-120 VAC, 6.3 Amps, 60 Hz, grounded
Capacity:	90 pints/day @ 80°F, 60% RH
Operating Temp.:	56°F min., 100°F max.
Air Flow:	200 CFM without external ducting
Refrigerant Charge:	1 lb., 12 oz. R22
Duct Connections:	Round 10" inlet, 10" outlet, 6" ventilation inlet
Filter Size:	Pleated cloth: 14" X 14" X 1"
Unit Size (w/o duct collars):	34 <sup>1</sup> / <sub>2</sub> "L x 15 <sup>3</sup> / <sub>4</sub> "W x 20 <sup>7</sup> / <sub>8</sub> "H
Weight:	92 lbs Shipping Weight: 99 lbs

## 4. Installation

### 4.1 Installation Checklist

# ! IMPORTANT

Prior to installation of the UA-90H, the following checklist should be reviewed. The UA-90H can be installed in a variety of locations to meet the owner's needs, and integrate with existing forced air systems or existing ductwork if desired. The location choice is contingent on a variety of requirements not limited to: ease of service, controls access, drainage, filtration, power, fresh-air ventilation, water damage prevention, and current regulatory codes (ASHRAE, fire, etc). Please address all of these issues before you select the device's location.

#### ■ 4.1A Power Accessibility

Unit should be located in an area where the cord's length (10') should easily reach a 115 VAC electrical outlet with a minimum of a 15 A circuit capacity.

#### ■ 4.1B Space

Location should have enough clearance to handle the unit's overall dimensions as well as the necessary return/supply ductwork to the unit.

#### ■ 4.1C Low Voltage Wiring

Unit location should be in an area where field wiring the remote controls (low voltage) to the unit will be possible.

#### ■ 4.1D Back-Draft Damper

It is recommended that a back draft damper be used in the discharge duct of the UA-90H, especially when connecting to the supply ducting system. The backdraft damper prevents supply air from counter flowing through the UA-90H when it is not operating. The unit location should be chosen to allow installation of this accessory if requested by the end user.

#### ■ 4.1E Support Structure and Suspension

Place the UA-90H on supports to raise the base of the unit. Do not place the UA-90H directly on structural building members without vibration absorbers or unwanted noise may result.

The UA-90H may be suspended with steel hanger straps (plumbers tape) or a suitable alternative from structural members, as long as the suspending assembly supports the UA-90H's base in its entirety. Do not hang the UA-90H from the cabinet. Remember to place a drain pan under the unit if it is suspended above a finished area or above an area where water leakage could cause damage.

### 4.2 Electrical Requirements

# ! WARNING

**WARNING: DO NOT ALLOW THE YELLOW LEAD FROM THE ULTRA-AIRE TO CONTACT THE RED LEAD FROM THE ULTRA-AIRE OR DAMAGE TO THE TRANSFORMER WILL RESULT.**

The UA-90H plugs into a common grounded 115VAC outlet. The device draws 6.3 Amps under normal operating conditions. If used in an area which may become wet, a ground fault interrupter (GFI) protected circuit is recommended. Please, consult local electrical codes for any further information.

Therma-Stor LLC offers a family of control devices for use with the UA-90H. The controls are to be located remotely from the unit and located in the space to be conditioned. The controls are low voltage (24 volt) and should be connected to the UA-90H with low voltage wire (thermostat or other appropriate).

## **IMPORTANT**

**Do not install the control panel where it may not accurately sense the relative humidity such as near HVAC supply registers, near exterior doors, on an outside wall, near a window, or near a water source.**

The installer must supply the wiring between the UA-90H and the control panel. Be sure to safely route the control wiring to prevent damage during installation.

## **CAUTION**

Do not cross wires when connecting the UA-90H and the remote control panel or damage to the transformer may result. The remote controls of the UA-90H are powered by a low voltage circuit (24VAC) and must NEVER contact or be connected to a high voltage circuit.

The control wires leaving the UA-90H and the remote control panels are numbered and color-coded to prevent confusion. Some of the control wires leaving the UA-90H may not be used with certain control panels and should be left unconnected with wire nuts taped onto the stripped ends for safety. Be sure to consult the electrical schematic in this manual or inside the access panel of the UA-90H before making control connections.

### **4.3 Condensate (Water) Removal**

## **IMPORTANT**

A trap in the drain line is preferred, but not required for the unit to drain properly. Local codes may require a trap. Use care to keep the pipe assembly as flat to the floor as possible. Kinks and/or humps will prevent proper drainage. The UA-90H generates condensate. Install a 3/4" male nominal pipe thread adapter to the drain pan. It is necessary to assemble your own drain pipe assembly utilizing 3/4" PVC pipe to get the condensate to a floor or other drain. Pipe is commonly available in 10' lengths from building supply, plumbing or hardware stores. Grade of pitch should be 1" per 10'.

#### **4.3A Lifting Condensate**

An optional condensate pump kit may be installed if a lift is required to dispose of the condensate. The condensate pump can be ordered direct from the factory. See the optional parts list in Section 8 for information on the kit.

#### **4.3B Condensate Pump Kit**

An optional condensate pump kit is available from the factory for use with the UA-90H. Condensate is automatically pumped to a

remote location when the water level in the pump's reservoir rises to close the float switch. The pump also contains a safety float switch. The white leads from this switch extend from beneath the pump cover. This switch should be installed in series with the field wire that connects the blue (#5) lead from the UA-90H to the control panel. If the pump fails, this switch opens the compressor control circuit and stops water production before the reservoir overflows. The UA-90H will continue to ventilate or circulate air as normal, but will not dehumidify until this switch closes.

### **4.4 Ducting**

## **IMPORTANT**

Attention: For ventilation only! Remove label and 6" round insulation from the duct prior to installing ducting for outside ventilation. For all other applications leave in place.

For the ideal installation, draw air from the central part of the home and return it to the isolated areas of the home like the bedrooms, den, utility room, or family room. The ductwork of the existing heating system can be used to supply air to the home. If the existing supply goes to isolated areas of the home, discharge the supply of the UA-90H into the supply of the existing heating system. Installation of a separate supply duct to the UA-90H from a central area is recommended.

#### **4.4A Fresh Air/Supply Air**

## **IMPORTANT**

**DO NOT draw air directly from the kitchen, laundry, or isolated basement.**

You may draw air from a basement that is open to the home. All flexible ducting connected to the UA-90H should be UL listed.

A short piece of flexible ducting on all UA-90H duct connections is recommended to reduce noise and vibration transmitted to rigid ductwork in the structure. Ducting the UA-90H as mentioned requires consideration of the following points:

Duct Sizing: For total duct lengths up to 25', use a minimum 10" diameter round or equivalent rectangular. For longer lengths, use a minimum 12" diameter or equivalent. Grills or diffusers on the duct ends must not excessively restrict airflow.

## FOR HVAC INSTALLER ONLY

**Isolated Areas:** Effective dehumidification may require that ducting be branched to isolated, stagnant air flow areas. Use 8" or larger diameter branch ducting to each of two or three areas, use 6" or larger to each of four or more areas. Provisions must be made to provide airflow from supply locations to central return location. Proper air distribution is important to ensure even humidity control and heat distribution throughout the structure. See Figure 1.

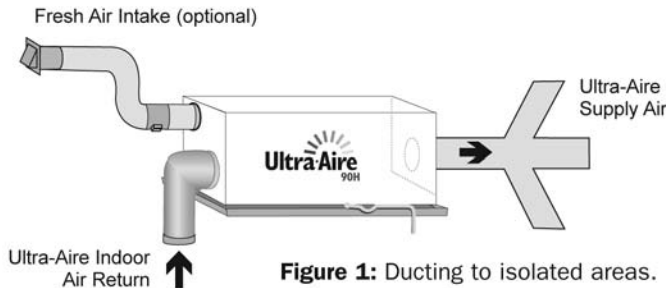

**Figure 1:** Ducting to isolated areas.

**Connecting to existing HVAC systems:** An optional 10" check backdraft damper is available from the factory to prevent reverse air flow through the UA-90H. If the UA-90H is ducted to the supply of an air handler, the check damper should be placed in the UA-90H supply duct. Ventilation operation is controlled by the remote controls offered with the UA-90H. These controls determine the time/frequency that the unit introduces outside air. The amount of outside air can be restricted by the blade damper in the 6" collar. Some control options require a 6" motorized damper be installed in the 6" fresh air duct.

## ! IMPORTANT

Contact the factory when connecting to a static pressure of greater than or equal to  $+0.5$ " WG.

### 4.4B Ducting for Fresh Air — Option

Fresh air may be brought into the structure by connecting an insulated duct from outside the structure to the 6" inlet of the UA-90H. Advantages of this form of ventilation include:

1. Outside air is filtered before entering the building.
2. Outside air will be dehumidified before entering if the UA-90H is running in dehumidification mode.
3. Drawing air from outside and blowing inside aids in slightly pressurizing the structure. This helps prevent dirty and humid air from entering elsewhere. It also reduces the potential for carcinogenic radon gas to enter and provides a small amount of make-up air for open combustion and exhaust devices like the clothes drier, fireplace, and water heater.
4. Exhaust fans are recommended in the bath rooms and kitchen.

In cold climates or areas where the outdoor dew point is low at times, ventilation can be used to dehumidify the structure, making the UA-90H capable of year-round drying. This is accomplished by bringing the dry, low dew point air into the structure during these times. This approach is often more economical than running the dehumidifier to remove excess moisture from the structure. In cold climates, it is critical to adequately ventilate to reduce the inside moisture content to avoid moisture accumulating in the wall cavities. For example; in a house that experiences condensation on the interior surface of the windows during the winter, increasing the amount of ventilation will often cure the problem.

An insulated 6" diameter duct is generally sufficient to provide up to 75 CFM of outside air. Large quantities of outside air will impact UA-90H performance positively or negatively, depending upon the inside and outside air conditions.

The outside air duct should be connected to the 6" round collar on the front of the unit. The amount of outside air can be restricted by the blade damper in the 6" collar. These controls determine the time/frequency that the unit introduces outside air. The amount/frequency of ventilation should be based on the size and occupancy of the residence. If you are unsure of your ventilation air requirements or have need for higher air flows, consult the factory by calling 1-800-533-7533 for assistance.

### 4.4C Installation in a Basement or Crawlspace with an Existing Forced Air HVAC System.

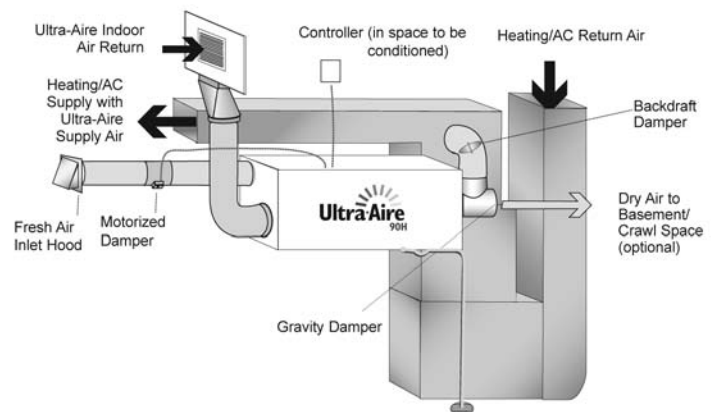

**Figure 2:** Basement or crawlspace installation.

**Basement Installation:** Install a separate 10" return for the UA-90H in a central area of the structure. Optional: Duct the supply of the Ultra-Aire to a 10" x 10" x 10" tee/damper, adjusted to 20% open to the basement. Duct the other side of the tee to the air supply of the existing HVAC system with a backdraft damper. Connect a duct from outside to the 6" collar of the Ultra-Aire if you wish to provide ventilation air. See Figure 2.



## FOR HVAC INSTALLER ONLY

**Crawlspace Installation:** Install a separate return for the UA-90H in a central area of the structure. Optional: Duct the supply of the UA-90H to a 10" x 10" x 10" tee/damper that is 20% open to the crawlspace if desired. Duct the other side of the tee to the air supply of the existing HVAC system with a backdraft damper. Connect an insulated duct from outside to the 6" collar of the UA-90H if you wish to provide optional ventilation air.

Instead of installing a separate return to the UA-90H, and if the existing system has multiple returns, it is possible to select one to disconnect from the existing forced air system and use it for the dedicated Ultra-Aire return. Always select a return from a central location in the structure in an area that is always open to the rest of the structure. Do not use a return from a room that may have its door closed much of the time or, alternatively, install a separate return from the open part of the house.

### 4.4D Installation in an Attic with an Existing Forced Air HVAC System

## ! IMPORTANT

**ALWAYS install a catch pan with a drain or float interrupt for condensate under the UA-90H in an attic or condensate may damage the living space below.**

The interrupt switch should be installed in series with the field wire that connects the blue (#5) lead from the UA-90H to the blue (#5) lead on the control panel. If overflow occurs, this switch opens the compressor control circuit and stops water production before the catch pan overflows. The UA-90H will continue to ventilate or circulate air as normal, but will not dehumidify until this switch closes.

The preferred method of installation is to create a separate return for the UA-90H in a central area of the structure. Duct the supply of the UA-90H to the air supply of the existing HVAC system. Connect an insulated duct from outside to the 6" collar of the UA-90H if you wish to provide fresh make-up air. Adjust a damper in the duct to provide the desired.

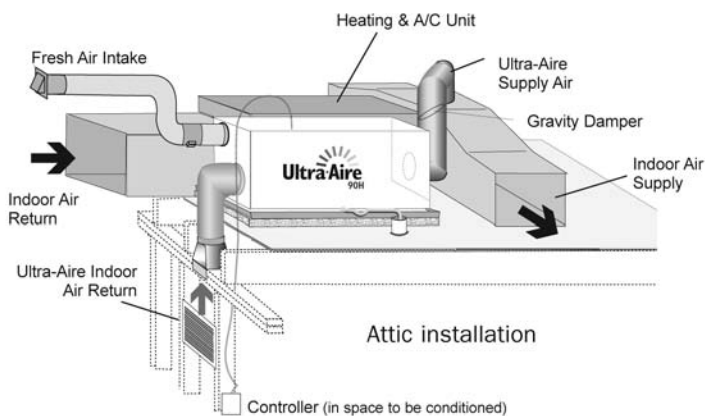

### 4.4E Installation in a Structure with No Existing Forced Air HVAC System

When installing the UA-90H in a structure that does not have a forced air HVAC system, a single return for the UA-90H should be installed in central open area of the structure. DO NOT locate the return in a bathroom or a kitchen. The supplies of the UA-90H should be located in the remote areas of the structure (such as bedrooms, den, etc.). By ducting this way, the air inside the structure will circulate through the UA-90H to be filtered and dehumidified. 6" diameter duct is recommended for branches to the bedrooms, 8" diameter duct is recommended for branches to larger areas. Connect an insulated duct from outside to the 6" collar of the UA-90H if you wish to provide ventilation. See Figure 4.

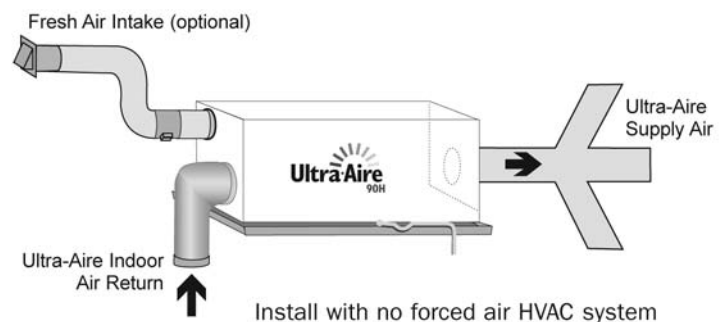

### 4.4F Ducting for High Efficiency Filtration

The standard filter included with the UA-90H is a very effective MERV 11 media filter. Additional filtering options, including charcoal filtration and 95% efficient filtration, are available with an optional external filter housing that may be installed with the UA-90H. The filter box is ducted to the intake of the UA-90H, and the intake ducting is then connected to the intake side of the filter box. See the optional accessories list or call the factory for details.

### 4.5 Noise Abatement

A length of 10 feet or more of acoustical flex ducting on the outlet of the UA-90H will reduce air noise from the fan. A length of flexible ducting on all UA-90H duct connections is recommended to reduce noise transmitted to rigid ductwork in the structure.

### 4.6 Controls

All control panels should be mounted in a central area of the structure where it can accurately sense the humidity of the air in the living space and be accessed. All controls require field wiring from the unit location to the panel mount location.

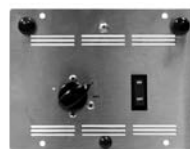

**Figure 1:**  
Humidity/Fan Control Panel  
Part No. 4024155



**Figure 2:** Ventilation Timer  
and Humidity Control Panel  
Part No. 4024125

To determine how each control operates the UA-90H, it must first be determined which control is being used and whether or not the 90H is ducted for fresh air ventilation. Refer to appropriate section.

## Humidity/Fan Control Panel (P/N 4024155) (Figure 1, p.7)

- 4.6A Humidity/Fan Control Panel WITHOUT Fresh Air Ventilation or Damper
- 4.6B Humidity/Fan Control Panel WITH Fresh Air Ventilation and WITHOUT Damper
- 4.6C Humidity/Fan Control Panel WITH Fresh Air Ventilation AND Damper

## Ventilation Timer/Humidity Control Panel (P/N 4024125) (Figure 2, p.7)

- 4.6D Ventilation Timer and Humidity Control WITH Fresh Air AND Motorized Damper

## DEH 2000 Digital Control (P/N 4024539) (Figure 1, p.10)

- 4.6E Digital Controller WITH Fresh Air AND Damper
- 4.6F Digital Controller WITHOUT Fresh Air

### 4.6A Humidity/Fan Control Panel WITHOUT Fresh Air Ventilation or Damper

The humidity/fan control panel automatically controls the humidity of the living space. The humidity/fan control panel contains an adjustable humidity control and a fan switch. The panel has a cover that must remain open to the air within the living space for accurate humidity sensing. When the fan switch is in the “ON” position, air will be continually filtered and circulated throughout the home. For humidity control operation refer to section 4.7.

### 4.6B Humidity/Fan Control Panel WITH Fresh Air Ventilation and WITHOUT Damper

The humidity/fan control panel automatically controls the humidity of the living space. The humidity/fan control panel contains an adjustable humidity control and a fan switch. The panel has a cover that must remain open to the air within the living space for accurate humidity sensing. Outside air is continually introduced whenever fan is “ON.” Manual operation of fan filter switch controls outside air ventilation. Since the fan operates whenever the UA-90H is dehumidifying outside air will also be introduced. For humidity control operation refer to section 4.7.

### 4.6C Humidity/Fan Control Panel WITH Fresh Air Ventilation AND Damper

In this configuration, a motorized damper has been installed in the fresh air duct. When the fan/filter switch is in the “OFF” position, the damper is closed. The UA-90H will then circulate and dehumidify air to provide humidity control.

When the fan/filter switch is in the “ON” position, the motorized damper will open and the fan will run, introducing outside air. The unit may or may not be dehumidifying in the ventilation mode, depending on the humidity control setting. See Section 4.7 for humidity control operation.

### 4.6D Ventilation Timer and Humidity Control WITH Fresh Air AND Motorized Damper

Refer to sections 4.7 through 4.9C.

### 4.6E DEH 2000 Digital Control WITH Fresh Air AND Damper

Refer to Section 5.

### 4.6F DEH 2000 Digital Control WITHOUT Fresh Air

Refer to Section 5.

## 4.7 Humidity Control Adjustment

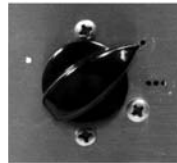

**Figure 3**  
Humidity Control Adjustment Knob

Set the humidity control to the desired humidity level for the home. Turning the knob clockwise results in a drier setting. See the back of the control panel cover for set points. The dehumidifier will run continuously until the relative humidity (RH) is reduced to the humidity control dial setting. Setting the humidity control to lower RH levels will NOT increase the dehumidification rate; the unit will simply run longer to reduce the RH to the setting. The UA-90H unit (and refrigerant-based dehumidifiers in general) will reduce a warm space's RH to a lower level than that of a cool space. Therefore there is no benefit to set the humidity control to excessively low levels in cool rooms; doing so will result in long periods of ineffective dehumidifier run time. Settings below 45% are not recommended.

## 4.8 Fan/Filter Switch



**Figure 4**  
Fan/Filter Switch

Turning ON the fan/filter switch will cause the UA-90H fan to run continuously, whether the UA-90H is dehumidifying or not. This function is desirable if the unit is used for air circulation and filtration to achieve maximum indoor air quality. When the switch is ON; air will be constantly filtered through the UA-90H and circulated throughout the house. When the switch is OFF the fan will operate only when the humidity control calls for dehumidification or when the ventilation timer calls for ventilation.



## 4.9 Ventilation Timer

The ventilation timer controls the fan and the motorized fresh air damper. When the ventilation timer is activated, the UA-90H will circulate the indoor air, and bring in fresh air from outside. The ventilation timer should be set for the required ventilation of the residence. The home should be ventilated with fresh air as suggested by applicable codes and standards or as required by the homeowner. The ventilation timer is an electronic timer that displays the current time. This timer has battery backup, so it will not require resetting after a power outage. Following a prolonged power outage the display of the timer will flash on and off indicating a power outage has occurred. The one-minute time increments of the ventilation timer allow you to program the ventilation of your home to fit your schedule.

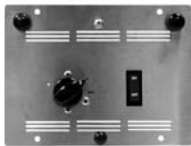

Humidity/Fan Control Panel  
Part No. 4024155



Ventilation Timer & Humidity  
Control Panel  
Part No. 4024125

The ventilation timer allows six programs with each program having one “ON” and one “OFF” event. A program allows the user to turn the ventilation on at a certain day and time, then it allows them to turn the ventilation off at a certain day and time. Each of these programs can be repeated daily or weekly or during a specified block of days. All six of the programs operate independently of each other. If the timer fails to operate or operates erratically, check that the control panel receives 24Vac from the UA-90H. If 24Vac is present at the control panel, reset the timer by pressing the reset button at the bottom center of the timer face. The reset button is the small recessed button with an R beneath it located below the 1-7 and h buttons. Depress the reset button until the display clears. Release the reset button. The display will reappear as 00:00. Resetting the timer will clear the time and all program settings. After resetting the timer follow the instructions below to set the correct time and ventilation programs.

### 4.9A Setting the Time

Set the correct time on the timer by sliding the switch in the upper right hand corner of the timer to the clock symbol. and pressing the 1-7 (DAY), h (HOUR), and m (MINUTE) buttons. Remember this timer operates on a 24-hour (military time) clock.

### 4.9B Ventilation Schedule

Slide the switch in the upper right hand corner to the program symbol P. “ON” will appear to the right of the time and the number “1” will appear in the lower right hand corner of the display. The “1” and “ON” signify the turn on time for the first program. Press the 1-7, h and m button to choose the days of the week for this program. You can choose Mon.-Sun., Mon.-Fri., Sat.-Sun., or any single day of the week. The days chosen are shown along the top of the display on the ventilation timer. Next press the h button to set the hour for the start of the ventilation period. Remember this timer operates on a 24-hour clock (military time). Then press the m button to set the minutes past the hour to start the ventilation.

Now, with the ventilation start time set; press the I/O button. The word “OFF” should appear to the right of the time and the number “1” should remain in the lower right hand corner of the display. The “1” and “OFF” signify the turn off time for the first program. Set the turn off time using the 1-7, h and m buttons in the same way as described above and continue on to the second through sixth programs. When setting the ventilation programs, you can return to the current time display by sliding the switch in the upper right corner of the timer to RUN. The slide switch must be set to RUN for the timer to operate its scheduled programs.

### 4.9C Automatic or Manual Mode

The slide switch in the upper left of the timer is used to choose between automatic and manual operation. When the slide switch is set to AUTO mode, the UA-90H will ventilate when the scheduled programs call for ventilation. When the slide switch is set to manual (set to hand symbol on the right), the operation of the timer is controlled by the I/O button only. Pressing the I/O button will switch the ventilation timer between ON (detent) and OFF (detent). As you press the I/O button, “ON” or “OFF” will be displayed to the right of the time. The “ON” or “OFF” indicates if the ventilation timer is on or off. The I/O button will manually override scheduled programs if the timer is in AUTO mode.

# FOR HVAC INSTALLER ONLY

## 5. DEH 3000 Digital Control Installation Instructions



Control Part No. 4026570

### 5.1 Specifications

Part # (P/N)	4026570
Model:	DEH 3000 Digital Control
Electrical:	24 VAC
Humidity Range:	10 – 95% RH
Humidity Accuracy:	+/- 5%
Output:	3 Amps 24 VAC
Relay Capacity	5 Amps
Temp Range/Accuracy	2%
Size	4.95" wide x 4.19" high

# FOR HVAC INSTALLER ONLY:

### 5.2 Installation

This control panel must be installed in the conditioned space and in accordance with all applicable codes and standards. Follow the instructions below when installing and setting this control.

#### 5.2A Install Instructions

1. Separate the front panel from the back panel by depressing the middle sections of the top and bottom of the front panel.
2. Line the back panel up against the wall or flat surface onto which it is to be mounted and drill in the appropriate mounting holes.
3. Insert the screws and tighten down so they extend approximately 1/8" from the back plate.
4. Align the back panel so that the control is level.
5. Tighten the screws to lock into position.
6. Make the electrical connections to the terminals on the back panel as shown in the wiring diagram.
7. Reassemble the front to the back panel. Connect at the top first, then at the bottom.

8. Test connections (see Section 2.6)

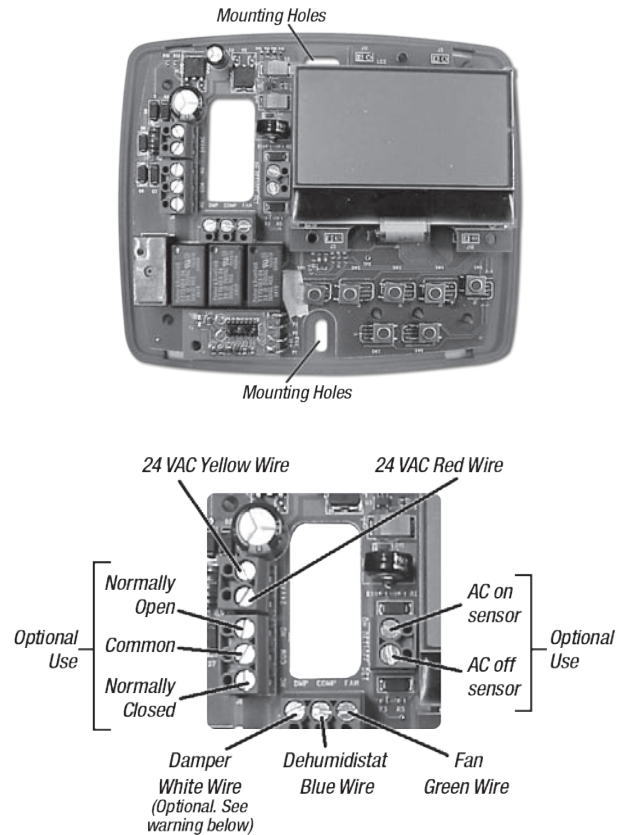

### 5.2B Wiring

**WARNING:** DO NOT ALLOW THE YELLOW LEAD FROM THE ULTRA-AIRE TO CONTACT THE RED OR WHITE LEADS FROM THE ULTRA-AIRE OR DAMAGE TO THE TRANSFORMER WILL RESULT

**WARNING:** UNPLUG ULTRA-AIRE BASE UNIT BEFORE WIRING CONTROL.

The installer must supply the wiring between the Ultra-Aire and the control panel. Be sure to safely route the control wires to prevent damage during installation. Be careful not to cross the wires when connecting the Ultra-Aire and the remote control panel or damage to the transformer may result.

The remote control of the Ultra-Aire is powered by a low voltage circuit (24 VAC) and must **NEVER** contact or be connected to a high voltage circuit. Some of the control wires leaving the Ultra-Aire may not be used with certain control panels and should be left safely disconnected with wire nuts taped onto the stripped ends. Be sure to consult the electrical schematic in this manual or on the front panel of the Ultra-Aire before making the control connections.

# FOR HVAC INSTALLER ONLY

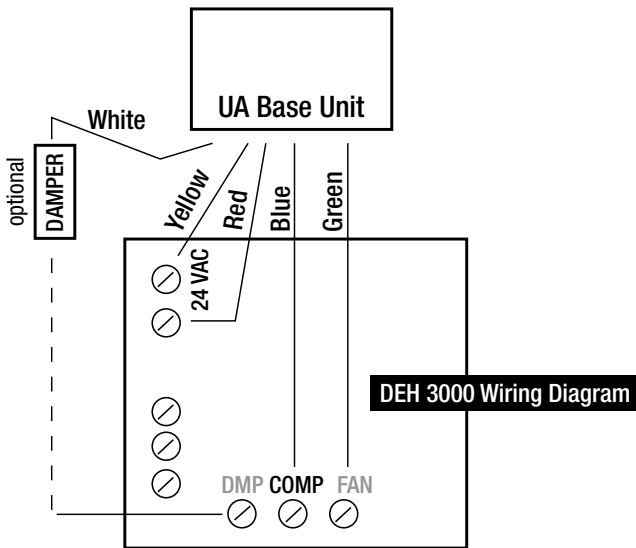

**WARNING:** TO AVOID TRANSFORMER DAMAGE ONLY CONNECT WHITE WIRE TO CONTROL IF DAMPER IS USED.

The white wire controls the optional motorized damper that can be installed into a fresh air duct. This provides the ability to control when fresh air is introduced into the building by using the ventilation timer function labeled “DMP” on the control (See Section 3.7). If the motorized damper is not used, **DO NOT CONNECT THE WHITE WIRE TO THE CONTROL OR DAMAGE TO THE TRANSFORMER MAY RESULT.** Simply leave the (DMP) terminal unused if the damper is not used, and cap off the white lead from the Ultra-Aire base unit.

## 5.2C Auxiliary relay operation

At times it may be desirable to coordinate fan operation of the central heating/cooling system with dehumidifier operation. The DEH 3000 features a relay that provides this ability. The relay terminals labeled NC, COM and NO operate according to the following chart:

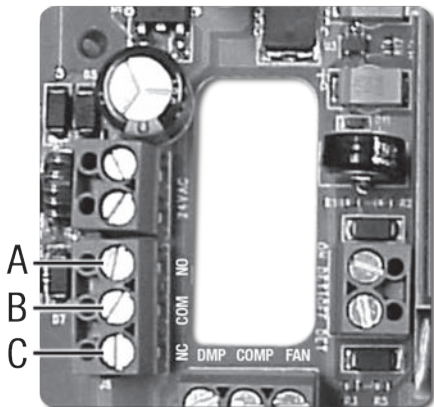

## Dehumidification

Operation	COM/NO	COM/NC
ON	CLOSED	OPEN
OFF	OPEN	CLOSED

Common uses (assuming standard thermostat wiring color schemes as noted):

### Disengage A/C during dehumidification

Redirect the yellow thermostat wire to the NC terminal. Wire the yellow wire from the A/C to the COM (B) terminal.

### Engage A/C during dehumidification

Connect a wire from the “R” terminal on the thermostat to the “com” terminal on the DEH 3000. Connect a wire from the “NO” terminal on the DEH 3000 to the “Y1” terminal on the thermostat.

## 5.2D Dehumidifier lockout/activation AC sensor

The control has the ability to activate the dehumidifier or deactivate the dehumidifier when the air conditioner is running.

24 VAC Yellow wire from dehumidifier

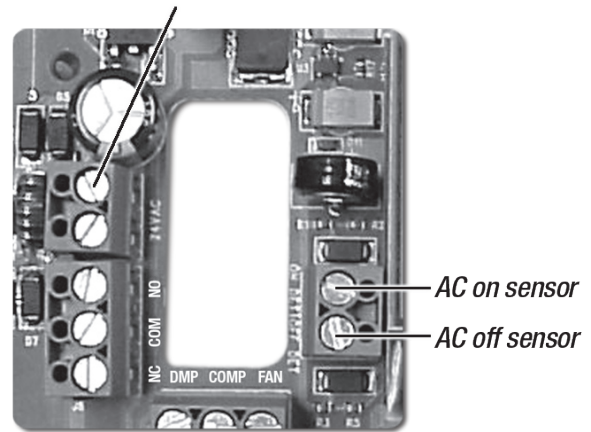

Standard wire colors for thermostats are as follows:

Description	Color	Terminal code
24VAC Return	Red	R
Call for Heat	White	W or W1
Force Fan On	Green	G
Compressor Call for Cooling	Yellow	Y or Y1

# FOR HVAC INSTALLER ONLY

## DEHUMIDIFIER DEACTIVATES WHEN THE AIR-CONDITIONER IS RUNNING

- The common wire on the thermostat transformer (black) needs to be wired with the yellow wire from the dehumidifier.
- The Red wire on the thermostat needs to be wired with the Yellow wire from the dehumidifier.
- The Yellow wire from the thermostat must be wired to the AC off sensor terminal.

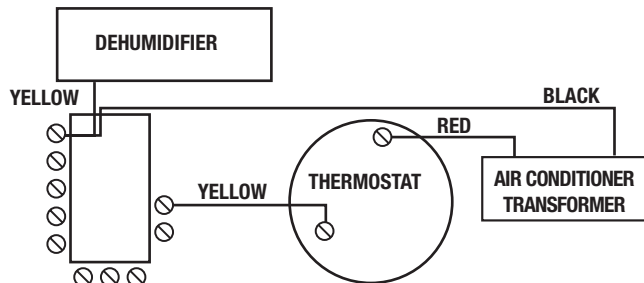

## DEHUMIDIFIER ACTIVATES WHEN THE AIR-CONDITIONER IS RUNNING

- The common wire on the thermostat transformer (black) needs to be wired with the yellow wire from the dehumidifier.
- The Red wire on the thermostat needs to be wired with the Yellow wire from the dehumidifier.
- The Yellow wire from the thermostat must be wired to the AC on sensor terminal.

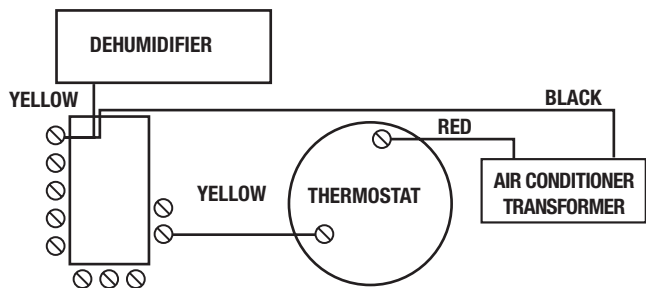

### 5.2E Location

Install the remote control panel in a central area of the structure where it will sense the relative humidity of the structure accurately. Do not install the control panel where it may not accurately sense the relative humidity such as near HVAC supply registers, near exterior doors and windows, or near a pool or spa.

### 5.2F Testing

After wiring connections have been made, verify connections. First, make sure the white wire from the base unit is not wired directly to the DEH 3000 control. There must be a

motorized damper in series with these connections, or the white wire must not be connected to the control. Mis-wiring may result in transformer damage.

**After connections have been verified, this short test will confirm proper wiring.**

1. Install front cover of control; insert at top first, then bottom.
2. Plug in Ultra-Aire base unit. The control should power up.
3. Turn control on by pressing the ON/OFF button.
4. Engage dehumidification operation by adjusting RH setpoint below ambient conditions.
  - a. Press RH until RH setpoint is 20%.
  - b. Verify Ultra-Aire fan and compressor operation.
  - c. Verify ventilation damper (if used) is closed.
5. Verify fan only operation by disengaging dehumidification and operating fan:
  - a. Adjust RH setpoint above ambient conditions by pressing and holding RH until set point is 80%.
  - b. Press fan button, then press again to toggle fan to "ON" setting.
  - c. Release fan button, then press again to toggle fan to "ON" setting until "FAN" flashes on display.
  - d. Verify fan operation of Ultra-Aire. No compressor operation should be noted, and ventilation damper (if used) should be closed.
6. Verify ventilation damper operation (if installed) by disengaging from operation and engaging ventilating operation.
  - a. Press and hold fan button until "FAN" flashes on display.
  - b. Release "FAN" button, then press again to toggle fan operation off.
  - c. Press and hold "VENT" button until "VENT" flashes on display.
  - d. Release "VENT" button, then press again until "OPEN" is displayed.
  - e. Verify Ultra-Aire fan operation and ventilation damper is open, with no compressor operation.
7. If any functions are not working properly, verify wiring and connections. Meters may be used across terminals to verify voltage. If there is a concern about the base unit not operating properly, the leads exiting the base unit may be connected and operation verified according to the following matrix:

Wire connections	Operation
Yellow & Blue	Fan & Compressor
Yellow & Green	Fan Only

**Do not test any other connections or transformer damage may result. Refer to the appropriate Ultra-Aire base unit manual for additional information.**

## FOR HVAC INSTALLER AND HOMEOWNER

- Verify additional optional control operations such as fan interlock or lockout.
- Proceed to operation/setting section.

### FOR INSTALLER & HOMEOWNER:

#### 5.3 Operation

##### 5.3A Display

- When there is power to the control, the control display will show the time, day, humidity, and temperature.
- When the control is turned on, the setpoint, fan status, auto/hold mode, and fresh air vent status is displayed.

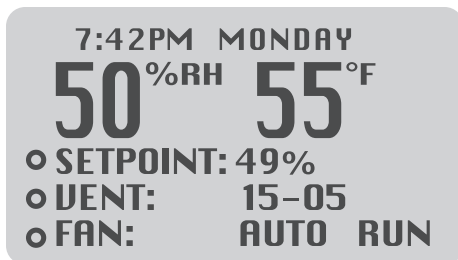

- When a key is pressed the display will light.
- The “**TIME**” and “**DAY**” is displayed at the top of the screen.
- RH and Temperature are displayed in real time.
- An “**○**” before the set point, vent, or fan indicates the unit is operating the device.
- A flashing “**○**” before the set point, vent, or fan indicates the unit is in a delay prior to operating the device.

**Note: Delay is an intentional factory installed time delay cycle that is meant to prevent short cycles, extending the life of the Ultra-Aire. If a delay is encountered, WAIT 10 MINUTES BEFORE EXPECTING NORMAL OPERATION.**

##### 5.3B Setting

During the set-up process, if you make a mistake, simply continue. You can always go back to adjust the settings. If you leave the control alone and don't touch any buttons for 10 seconds, the control will remember any changes made and return to “home.”

##### 5.3C On/Off Setting

Press the “**ON/OFF**” button to turn the system on or off. When the system is on, the setpoint, fan status, auto/hold mode, and fresh air vent status is displayed. In the off mode, the control will show the time, day, humidity, and temperature. When the unit is shipped, it is in manual mode.

##### Hold Mode

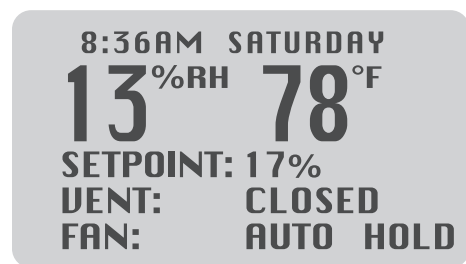

##### Auto Mode

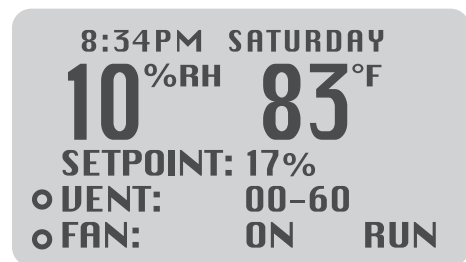

##### Off



##### 5.3D Setting Clock Time

- Press and hold the “**CLOCK**” button. The hour display will flash. Release the button.
- Use the “**UP/DOWN RH**” buttons to change the value.
- Press the “**CLOCK**” button again and the minute display will flash. Use the RH buttons to change the value.
- Press the “**CLOCK**” button again and the “**AM/PM**” display will flash. Use the RH buttons to toggle the value.
- Press the “**CLOCK**” button again and the day display will flash. Use the “**RH**” buttons to change the value.

If the “**CLOCK**” button is pressed again or no button is pressed for 5 seconds, the display will automatically return to “home.”

##### 5.3E Setting Relative Humidity Setpoint

The relative humidity setpoint (the average RH that is maintained) operates the dehumidifier function of the Ultra-Aire. It has no effect on any other function of the unit. The control senses the ambient relative humidity of the space in which it is located.



## FOR HVAC INSTALLER ONLY AND HOMEOWNER

### Operation

The initial dead band setting (the range that the dehumidifier cycles on and off) is 3%. With a setpoint of 50%, the dehumidifier turns on when the reading reaches 53%. The dehumidifier continues to remove water from the air until the reading is 47%. The dehumidifier remains off until the reading is 53%.

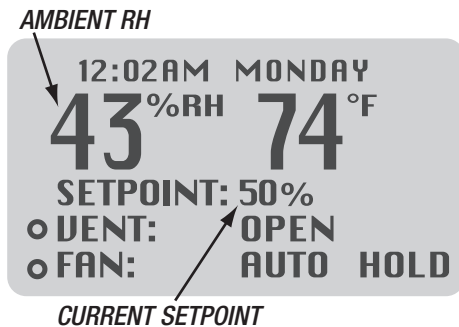

If the setpoint is equal to or greater than the current ambient condition, the space does not need to be dried so the dehumidifier function will be off.

Example: Setpoint: 50% RH  
Current condition: 45% RH = Dehumidifier off, the “○” indicator will not be shown.

If the setpoint is less than the ambient condition, the dehumidifier will be on and the red “DEHU” indicator will be lit. Since the space is more humid than the set point, the controller operates the dehumidifier to dry the space.

Example: Setpoint: 50% RH  
Current condition: 55% RH = Dehumidifier on, the “○” indicator will be shown.

To set the relative humidity setpoint, press up or down “RH” buttons to adjust the relative humidity setpoint as desired. Therma-Stor recommends relative humidity levels not exceed 50% in the summer, and 25-35% in the winter if you live in a cold climate. It is not recommended that the humidity setpoint be set below 35%. In order to dry the home in the winter in a cold climate, use the ventilation function of the system rather than the dehumidifier function. Call the factory or refer to the owner’s manual for more information.

### 5.3F Fan Setting and Operation

Use the “FAN” button to adjust the fan operation. There are 2 choices for fan operation: “ON” or “AUTO.”

“ON” – indicates the fan of the Ultra-Aire will run continuously. This does not affect either the dehumidification or ventilation functions of the system. In other words, the system may or may not be ventilating or dehumidifying while the fan is running. Common reasons for operating the fan

continuously are filtration and air recirculation.

“AUTO” – indicates the fan will run when the control calls for dehumidification or ventilation. If the control has not called for dehumidification for 3 hours, the control will automatically run the fan for 10 minutes. The fan must run a specific amount of time per day. This helps to keep the dehumidifier dry.

After dehumidification cycle, fan automatically shuts off for 10 minutes.

#### To set the operation:

1. Press and hold the “FAN” button. The current fan setting will begin to flash. Release the button.
2. Press the “FAN” button to toggle between the “ON” and “AUTO” modes.

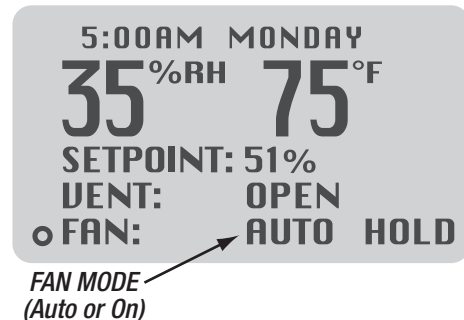

An “○” indicator indicates the fan is operating. A flashing “○” indicator indicates the fan is in a wait mode and will operate shortly. No “○” indicates the fan is off.

With the fan in the “AUTO” mode, the fan will operate only when needed by other functions of the system. The fan will remain off unless the system is dehumidifying and/or ventilating. The fan always runs during dehumidification and ventilation and the fan “○” icon will be lit. To completely turn the system off, use the “ON/OFF” button as described earlier. To adjust the ventilation mode see Section 3.7.

### 5.3G Damper Operation and Setting (Ventilation) Manual/Hold Mode

Ultra-Aire units can be installed to incorporate optional ventilation. The damper setting controls the ventilation function of the system. It has no control over the dehumidification function, although the ventilation function can and should be used to dry the space depending on the climate and the outside air conditions. Refer to the appropriate Ultra-Aire manual for more information.

In order to provide ventilation, the damper must be open (“ON”) and the fan must be running. The controller takes care of these two functions automatically, so that whenever the damper is open (“ON”), the fan is running.

## FOR HVAC INSTALLER ONLY AND HOMEOWNER

The ventilation indicator “**○**” will be displayed whenever the unit is ventilating. The fan operation indicator “**○**” will also be lit.

There are three damper operation modes, “**OPEN – HOLD**,” “**CLOSED – HOLD**” and “**PROGRAM**” (denoted by “**ON TIME**” – “**OFF TIME**.” Refer to section 3.8). With the damper in the “**OPEN – HOLD**” mode, the damper will be open and the fan of the system will be operating in order to introduce fresh air into the space. Use this mode for continuous fresh air ventilation. The fan is always on when the damper is open. When in “**CLOSED – HOLD**” mode, the damper will not open and the system will not ventilate.

When in the “program” mode, the control will operate the damper and fan (ventilate) according to the programmed ventilation schedule (See Section 3.8).

### To set the damper operation:

1. Press the “**VENT**” button. The current setting will begin to flash on the display. Release the button.
2. Press the “**VENT**” button again to toggle between “**OPEN**,” “**CLOSED**” and “**PROGRAM**.”
3. Leave the control alone for 10 seconds to select the indicated damper mode and return to “**HOME**.”

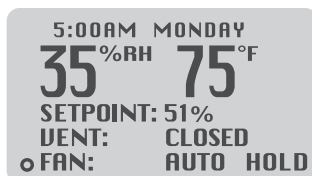
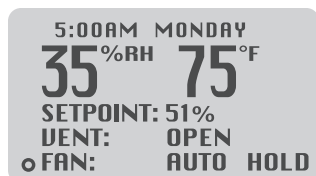

### 5.3H Intermittent or Programmed Ventilation

*This example shows the damper in “PROGRAM” mode (denoted by the schedule 15 minutes on, 5 minutes off).*

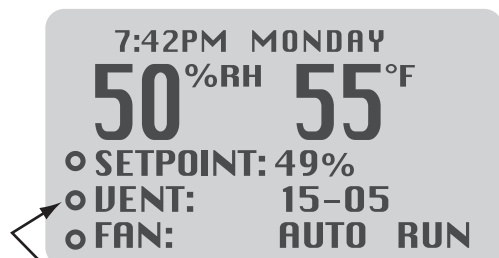

*The status of the damper is show here.*

**○** is open, blank is closed.

The system will operate the ventilation function according to the current ventilation program. The control needs to be programmed to turn the ventilation function on and off at the desired intervals. This is done by programming the ventilation timer.

There are two programs available for ventilation Monday through Friday. There are also two programs for Saturday and Sunday. No other choice of days is available.

### Each program has:

- A “**START**” time of day when the ventilation schedule begins.
- An “**OPEN FOR**” duration for the amount of time the damper stays open in 5 minute intervals, from 0 to 60.
- A “**CLOSED FOR**” duration which closes the vent for a specified time in 5 minute intervals from 0 to 60.

### Example:

1. Press “**PROGRAM ENTER**” button. The following menu appears:



2. Using the up/down RH buttons, select “**PROGRAM**.” The following menu appears:



### You can select from:

“**MON-FRI**” or “**SAT-SUN**” for separate weekday/weekend schedules or “**MON-SUN**” which gives you equal weekday/weekend schedules.

### Menu when you select “MON-FRI” or “SAT-SUN”:

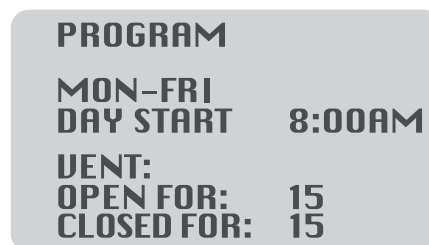

1. Enter the starting time for weekdays using the up/down RH keys to change the time.

## FOR HVAC INSTALLER AND HOMEOWNER

2. Press the program enter key to toggle to the “open for” setting. Using the up/down “RH” keys, change the duration that the damper will ventilate fresh air.
3. Press the program enter key to toggle to the “closed for” setting. Using the up/down “RH” keys, change the duration that the damper will remain closed between ventilation.

For the example given, starting at 8:00AM in the morning, the control will ventilate fresh air for 15 minutes then stop for 15 minutes. This schedule of 15 minutes open; 15 minutes closed will continue until the start time of the night schedule.

Press “PROGRAM ENTER” again to go to the “MON-FRI” night schedule. Repeat the steps listed above for this and the “SAT-SUN” day and night schedules.

When you return to the main program menu, use the up/down “RH” buttons to select “RUN PROGRAM.”

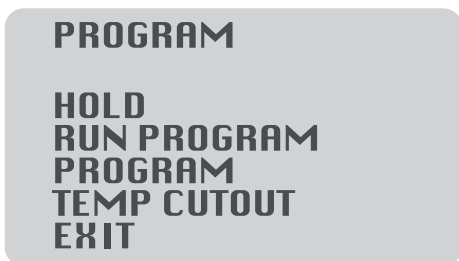

Press “PROGRAM ENTER” to run the program. The display will appear as follows:

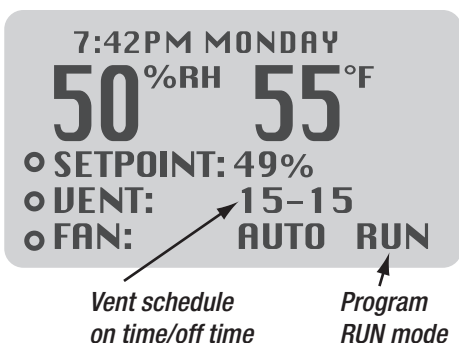

### 5.3I Temperature Cutout Programming

Ultra-Aire units produce heat when dehumidifying. Depending on outside conditions, the ventilation function may introduce warm air into the space. Occasionally, the operation of the Ultra-Aire may produce enough heat to drive temperatures up. The temperature cutout feature disables all Ultra-Aire operations if temperatures reach cutout setpoint. In most installations this

feature will not need to be used. If temperature cutout is desired, program the setpoint by pressing the “PROGRAM ENTER” button. Press RH until “TEMP CUTOUT” is flashing. Use “RH” up or “RH” down to adjust setpoints.

### 5.3J Default Settings

Upon initial power-up or after prolonged power outages (more than 30 minutes), the DEH 3000 is programmed with the following defaults. A space is provided to make note of user inputs.

Setting	Default	My Setting
RH setpoint	50%	_____
Ventilation Operation	Closed	_____
Fan Setting	Auto	_____
Temp Cutout	80%	_____

If you have questions about the DEH 3000, please call Therma-Stor LLC at 1-800-533-7533 or email us at [sales@thermastor.com](mailto:sales@thermastor.com)

# ATTENTION INSTALLER

## WIRE THE UNIT AND CONTROL PACKAGE AS SHOWN IN THE DIAGRAM BELOW

### Humidity/Fan Control Panel

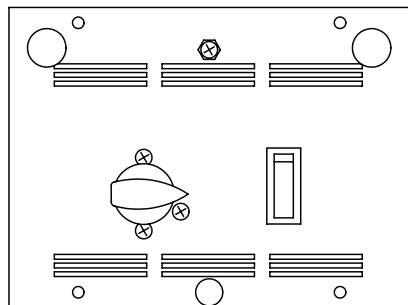

Control Part No. 4024155

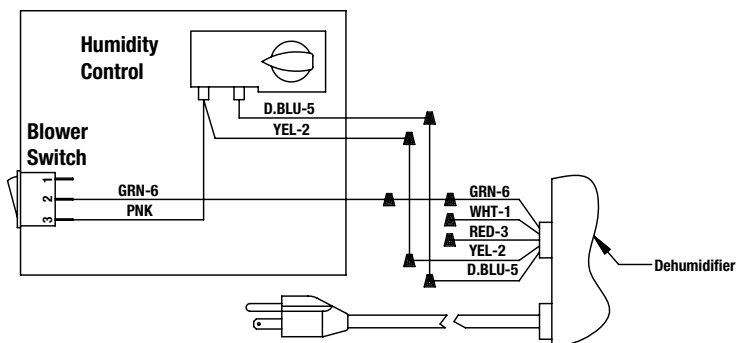

### Ventilation Timer/ Humidity Control Panel

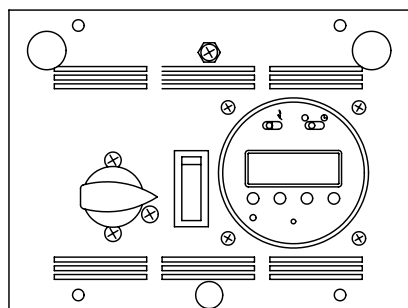

Control Part No. 4024125

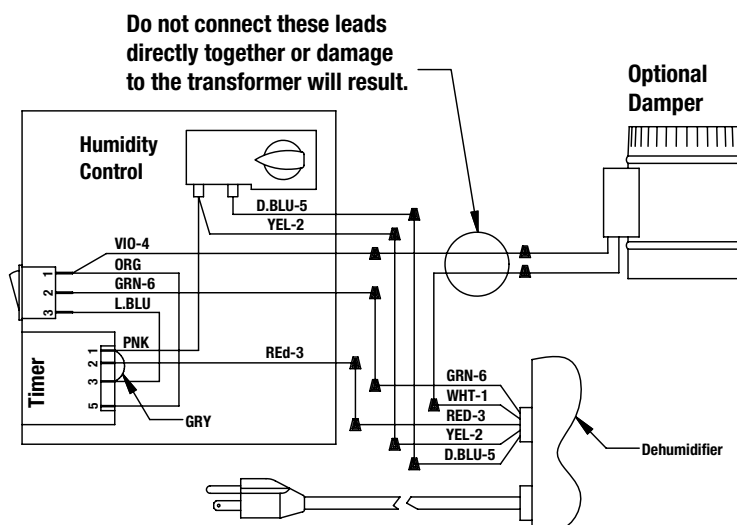

### DEH 3000 Digital Control



Control Part No. 4026570

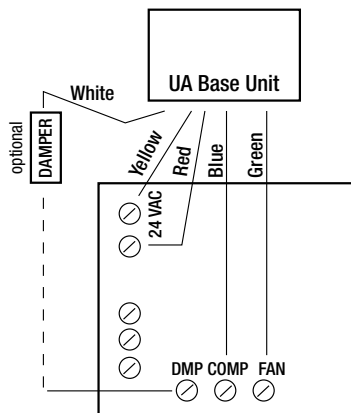

**WARNING: DO NOT** allow the yellow lead from the unit to contact the red lead or the white lead from the unit or damage to the transformers will result. Do not direct connect the white lead on the unit to the violet lead on the ventilation control or damage to the transformer will result.

## 7. Maintenance

### 7.1 Standard Air Filter

The UA-90H is equipped with a MERV 11 media filter. This filter should be checked every three months. Operating the unit with a dirty filter will reduce dehumidifier capacity and efficiency and may cause the compressor to cycle off and on unnecessarily on the defrost control.

**DO NOT operate the unit without the standard filter or with a less effective filter than the standard filter. The heat exchange coils inside the unit could become clogged and require disassembly to clean. Filter non-compliance invalidates the product warranty.**

### 7.2 High Efficiency Air Filter

Most filters are labeled with a MERV rating number, which measures a filter's ability to trap particles ranging in size from 3.0 microns to 10.0 microns. Residential filters commonly have MERV ratings of 1-12. The higher the MERV rating, the more efficient the filter is, and the more particles it can filter.

The UA-90H comes with a standard MERV 11 filter. A MERV rating of 11 means the filter is 85% to 95% minimum efficient at capturing the measured particles. For greatest filtration and efficiency of the UA-90H, it is recommended the air filter be replaced every three months with a MERV 11 rated filter.

### 7.3 Optional Fresh Air Intake

Check and clean the screen on the outdoor fresh air intake port seasonally. The screen may become plugged during the seasons when there are many particles in the outdoor air.



# ULTRA-AIRE 90H WIRING DIAGRAM

## 8. Wiring Diagrams

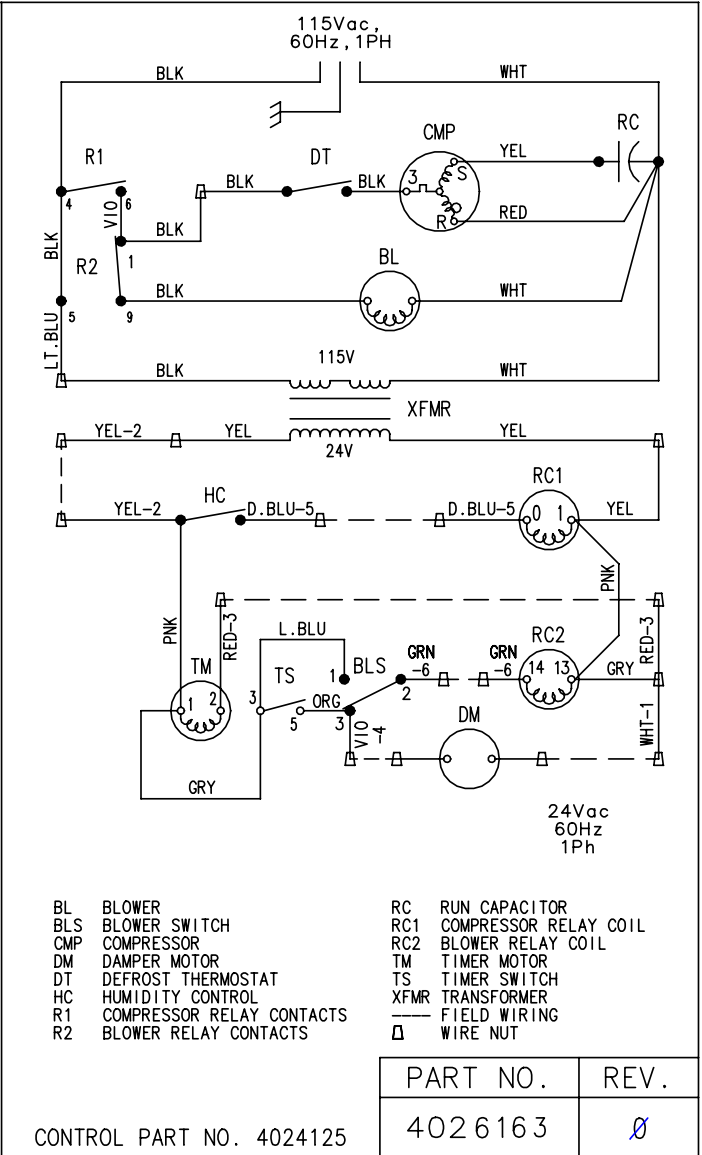
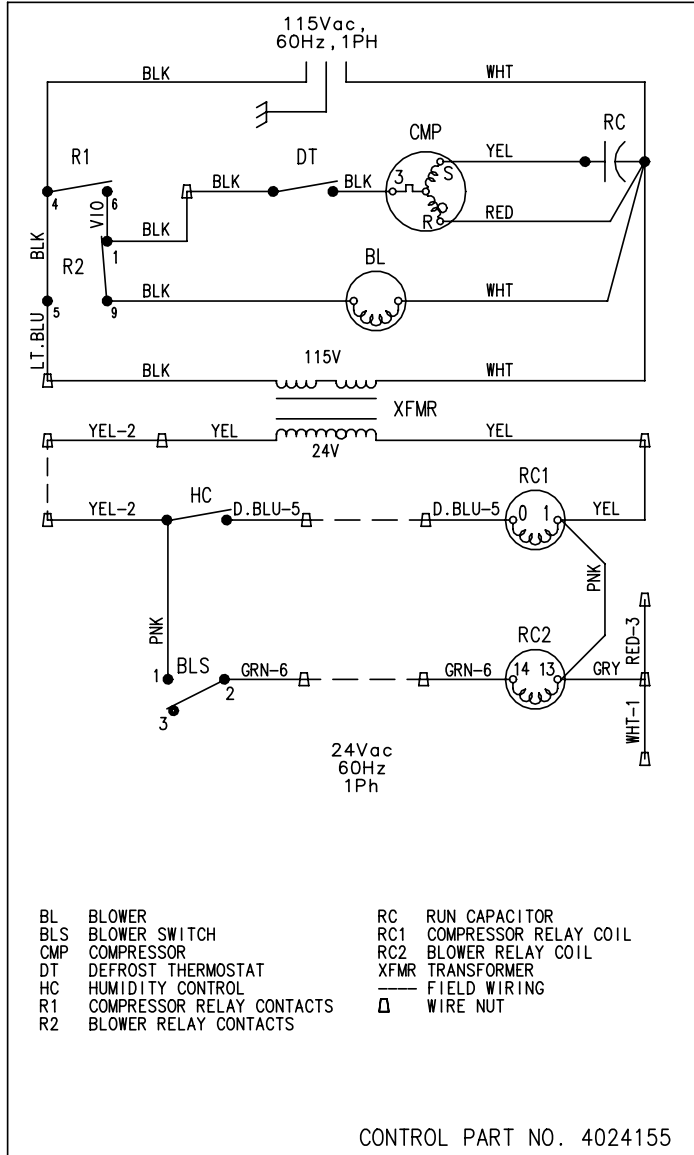

**UA-90H with Humidity/Fan Control  
(4024155)**

**UA-90H with Ventilation Timer/Humidity  
Fan Control (4024125)**

# FOR HVAC INSTALLER ONLY

## 9. Optional Parts List: UA-90H Indoor Air Quality System

Item	Part No.	Description
1	4024125	Control Panel Assembly, Ventilation Timer & Humidity Control
2	4024155	Control Panel Assembly, Humidity/Fan
3	4026570	DEH 3000 Digital Controller
4	4025287	Filter Box
5	4026151	14"x14"x1" Standard UA 90-H Filter
6	4024369	2"x20"x24" Filter (not shown) Use only with Filter Box
7	4024370	4"x20"x24" Filter (not shown) Use only with Filter Box
8	4026451	Condensate Pump Kit/UA-90H (not shown)
9	4026450	Leveling Foot Kit/UA-90H (not shown)
10	4020646	10" Backdraft Damper (not shown)
11	4023660	Controller, Humidity
12	4023672	Duct Damper, 6" Diameter, Electrically Actuated (not shown)
13	4024153	Cover for Items 1 & 2 (not shown)
14	4021495	Knob, Black, .25" shaft
15	4024150	Instructions, Humidity/Fan (not shown)
16	4024122	Instructions, Ventilation Timer & Humidity (not shown)
17	4020554	Switch, Black, SPDT, On/Off
18	4022486	Timer, 7-Day, 24 Vac, Programmable



**Item 1:** Ventilation Timer & Humidity Control

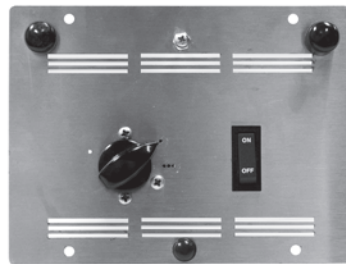

**Item 2:** Humidity/Fan Control

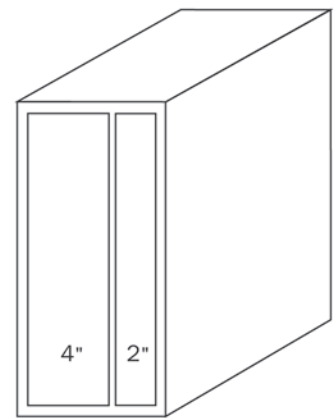

**Item 4:** Filter Box

**Item 3:** DEH 3000 Digital Control

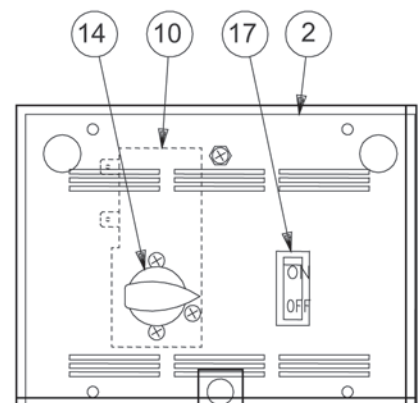
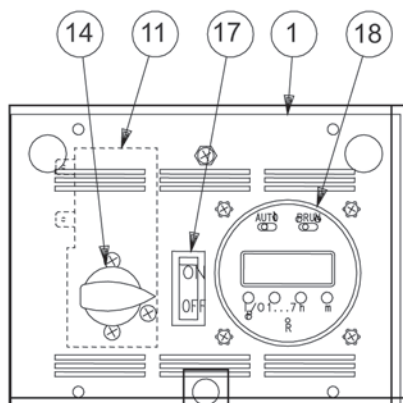

Accessories

## FOR HVAC INSTALLER ONLY

### 10. Service Parts List: UA-90H Indoor Air Quality System

Item	Part No.	Description
1	4023648	Compressor, Carlyle (EAA070111A)
2	4023681	Compressor Overload (EAA070111A)
3	4022484	Compressor Relay, SPST, 24 Vac, 30A
4	4024912	Compressor Run Capacitor, 25 MFD
5	4025561	Fan
6	4020924	Fan Relay, SPDT, 24 Vac, 15A
7	4022487	Transformer, 120/24 Vac, 40 VA
8	4025544	Condenser, Evaporator, Strainer & Capillary Tube Assembly

## FOR HOMEOWNER - ROUTINE MAINTENANCE

Item	Part No.	Description
1	4026151	14"x14"x1" Standard UA 90-H Filter
2	4024369	2"x20"x24" Filter (not shown) Use only with Filter Box
3	4024370	20"x24" Filter (not shown) Use only with Filter Box

It is recommended the filter be checked every six months. Operating the unit with a dirty filter will reduce dehumidifier capacity and efficiency and may cause the compressor to cycle off and on unnecessarily on the defrost control.

## 11. Service

### CAUTION

**CAUTION: Servicing the UA-90H with its high pressure refrigerant system and high voltage circuitry presents a health hazard which could result in death, serious bodily injury, and/or property damage. Call your HVAC contractor.**

### 11.1 Technical Description

The UA-90H uses a refrigeration system similar to an air conditioner's to remove heat and moisture from incoming air, and add heat to the air that is discharged. Hot, high-pressure refrigerant gas is routed from the compressor to the condenser coil (See Figure 1). The refrigerant is cooled and condensed by giving up its heat to the air that is about to be discharged from the unit. The refrigerant liquid then passes through a strainer and capillary tubing which causes the refrigerant pressure and temperature to drop. It next enters the evaporator coil where it absorbs heat from the incoming air and evaporates. The evaporator operates in a flooded condition, which means that all the evaporator tubes contain liquid refrigerant during normal operation. A flooded evaporator should maintain nearly constant pressure and temperature across the entire coil, from inlet to outlet.

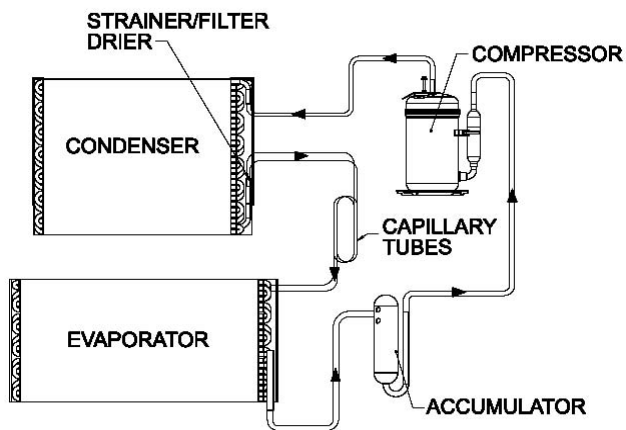

**Refrigeration System of UA-90H**

The mixture of gas and liquid refrigerant enter the accumulator after leaving the evaporator coil. The accumulator prevents any liquid refrigerant from reaching the compressor. The compressor evacuates the cool refrigerant gas from the accumulator and compresses it to a high pressure and temperature

### 11.2 Troubleshooting

**No dehumidification, neither fan nor compressor run with fan switch and ventilation timer OFF.**

1. Unit unplugged or no power to outlet.
2. Humidity control set too high or defective.
3. Loose connection in internal or control wiring.
4. Defective Compressor relay.
5. Defective control transformer.
6. Optional Condensate Pump Safety Switch open.

**No dehumidification, compressor does not run but fan runs with fan switch and ventilation timer OFF and humidity control turned to ON.**

1. Defective compressor run capacitor.
2. Bad connection in compressor circuit.
3. Defective compressor overload.
4. Defective compressor.
5. Defrost thermostat open.
6. Optional Condensate Pump Safety Switch open.

**Fan runs with fan switch and ventilation timer OFF, but compressor cycles on and off.**

1. Low ambient temperature and/or humidity causing unit to cycle through defrost mode.
2. Defective compressor overload.
3. Defective compressor.
4. Defrost thermostat defective.
5. Dirty air filter(s) or airflow restricted.
6. Low refrigerant charge, causing defrost control to cycle.
7. Bad connection in compressor circuit. Fan does not run with fan switch in either position.

**Fan does not run with ventilation timer activated. Compressor runs briefly but cycles on & off with humidity control turned to ON.**

1. Loose connection in fan circuit.
2. Obstruction prevents fan rotation.
3. Defective fan.
4. Defective fan relay.
5. Defective fan capacitor.

**Fan runs with fan switch ON. Fan does not run with ventilation timer activated.**

1. Defective ventilation timer.
2. Time not correct on ventilation timer.
3. Ventilation timer set to manual and switched OFF.
4. Defective fan switch.

**Evaporator coil frosted continuously, low dehumidifying capacity.**

1. Defrost thermostat loose or defective.
2. Low refrigerant charge.
3. Dirty air filter(s) or airflow restricted.
4. Excessively restrictive ducting connected to unit.

## Unit not providing ventilation. Ventilation timer not operating correctly.

1. If timer is not functioning correctly reset timer and reprogram.
2. Check control wire connections (check connections at fresh air damper also).
3. Defective fresh air damper.
4. Defective fan switch.

## Unit removes some water, but not as much as expected.

1. Air temperature and/or humidity have dropped.
2. Humidity meter and or thermometer used are out of calibration.
3. Unit has entered defrost cycle.
4. Air filter dirty.
5. Defective defrost thermostat.
6. Low refrigerant charge.
7. Air leak such as loose cover or ducting leaks.
8. Defective compressor.
9. Restrictive ducting.
10. Optional Condensate Pump Safety Switch open.

## Unit Test to determine problem:

1. Detach field control wiring connections from main unit.
2. Connect the yellow and green pigtailed wires from the main unit together; only the fan should run. Disconnect the wires.
3. Connect the yellow and blue pigtailed wires from the main unit together; the compressor and fan should run.
4. If these tests work, the main unit is working properly. You should check the control panel and field control wiring for problems next.
5. Remove the control panel from the mounting box and detach it from the field installed control wiring. Connect the blue, yellow, and green wires from the control panel directly to the corresponding colored pigtailed wires on the main unit. Leave the violet, white and red wires disconnected!
6. Turn on the fan switch; the fan should run. Turn off the fan switch.
7. Turn on the humidity control; the compressor and fan should run.
8. If these tests work, the problem is most likely in the field control wiring.

## 11.3 Refrigerant Charging

If the refrigerant charge is lost due to service or a leak, a new charge must be accurately weighed in. If any of the old charge is left in the system, it must be recovered before weighing in the new charge. Refer to the unit nameplate for the correct charge weight and refrigerant type.

## 11.4 Compressor/Capacitor Replacement

This compressor is equipped with a two terminal external overload and a run capacitor, but no start capacitor or relay.



**CAUTION-ELECTRICAL SHOCK HAZARD: Electrical power must be present to perform some tests. These tests should be performed by a qualified service person.**

## 11.5 Electric Ventilation Damper

The electric ventilation damper is controlled by the ventilation timer. The damper will open when the ventilation timer is activated to allow fresh air into the structure through the 6" diameter fresh air inlet duct. The electric ventilation damper will remain closed when the ventilation timer is not activated to prevent over-ventilating the structure when the unit is dehumidifying or recirculating the indoor air. The electric ventilation timer operates on 24 Vac from the control circuit. DO NOT connect high voltage to the damper motor or damage to the motor may result. DO NOT force the blade of the damper by hand or damage to the damper motor may result.

The damper opens in one direction only. The damper rotates very slowly, allow sufficient time for the damper to cycle. The damper will take approximately one minute to cycle from closed to open or from open to closed.

If the electric ventilation damper fails to operate:

1. Check that the wiring is correct and that voltage is present at the damper motor.
2. Check for any obstruction inside the damper. If the electric ventilation damper fails to operate after performing these checks, it must be replaced.

## 11.6 Condensate Pump Kit

An optional condensate pump kit is available from the factory for use with the UA-90H. Condensate is automatically pumped to a remote location when the water level in the pump's reservoir rises to close the float switch. The pump also contains a safety float switch. The white leads from this switch extend from beneath the pump cover. This switch should be installed in series with the field wire that connects the blue (#5) lead from the UA-90H to the blue (#5) lead on the control panel. If the pump fails, this switch opens the compressor control circuit and stops water production before the reservoir overflows. The UA-90H will continue to ventilate or circulate air as normal, but will not dehumidify until this switch closes. See following pages for more information.



# **ULTRA-AIRE 90H CONDENSATE PUMP INSTALLATION INSTRUCTIONS**

THIS CONDENSATE PUMP KIT MUST BE INSTALLED WITH LEVELING FEET. DO NOT USE CASTERS.

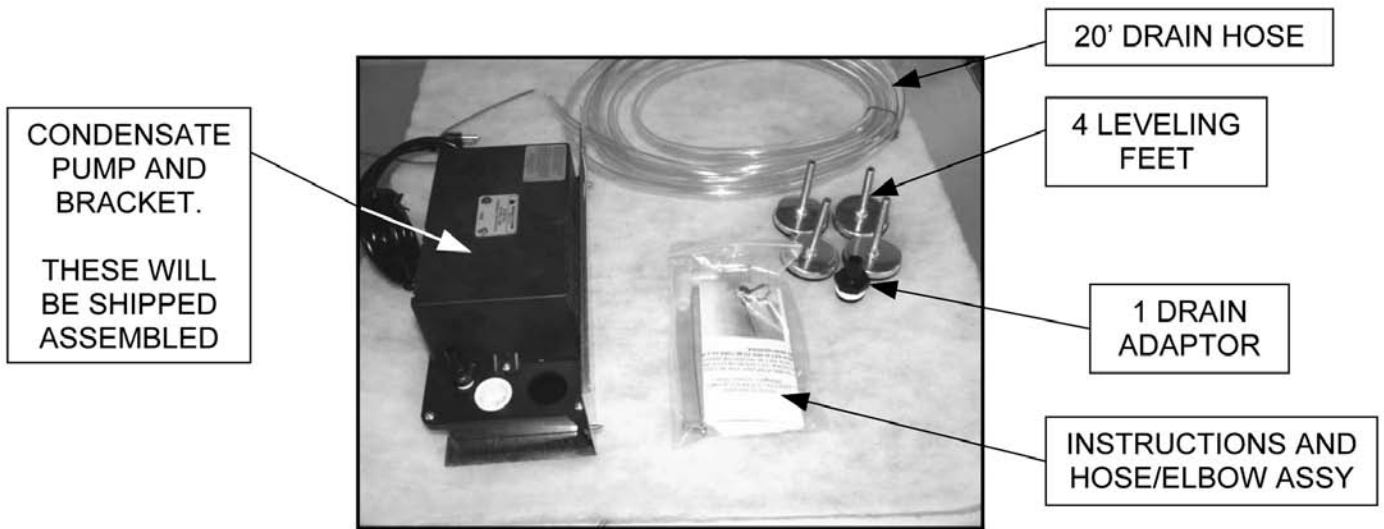

THIS KIT INCLUDES THE HARDWARE LISTED ABOVE.

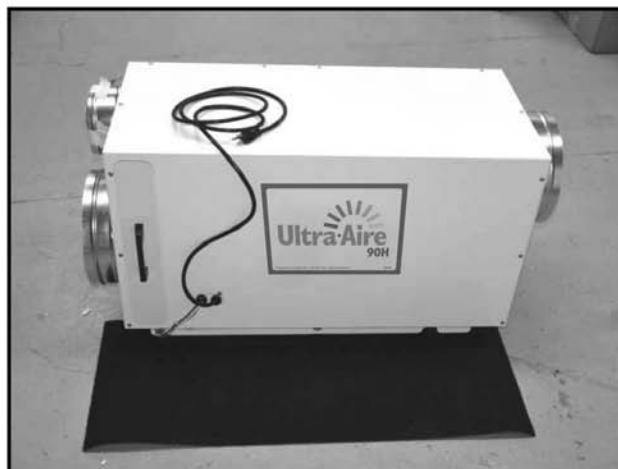

THE ULTRA-AIRE 90H DEHUMIDIFIER

# CONDENSATE PUMP INSTALLATION: FOR HVAC INSTALLER ONLY

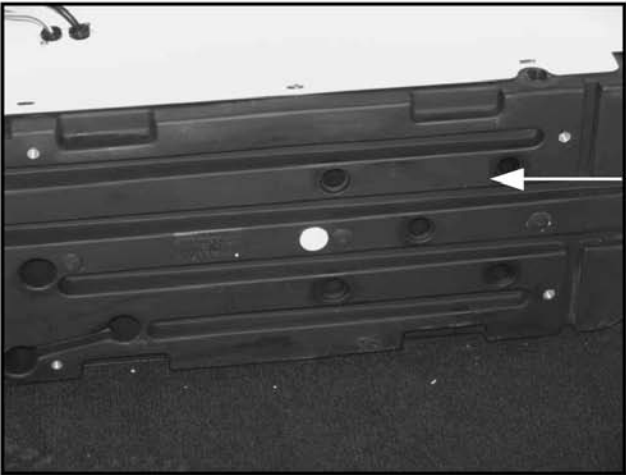

BOTTOM OF DEHUMIDIFIER

STEP 1: LAY THE UNIT ON IT'S SIDE. MAKE SURE THE FILTER DOOR IS FACING UPWARD.

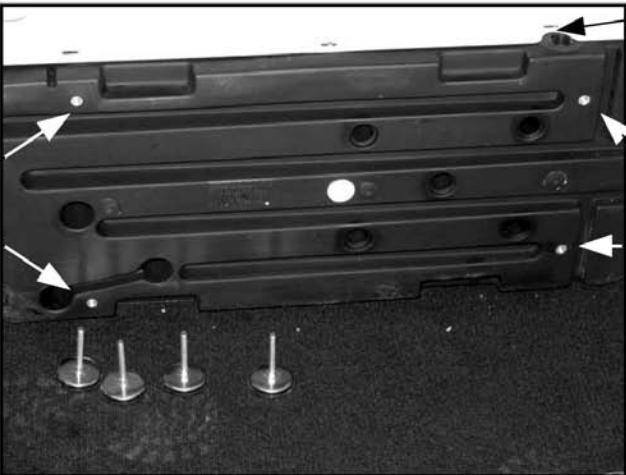

HOSE ADAPTOR

CASTER LOCATION

CASTER LOCATION

STEP 2: NOTE THE LOCATIONS OF THE FOUR LEVELING FEET AND THE HOSE ADAPTOR

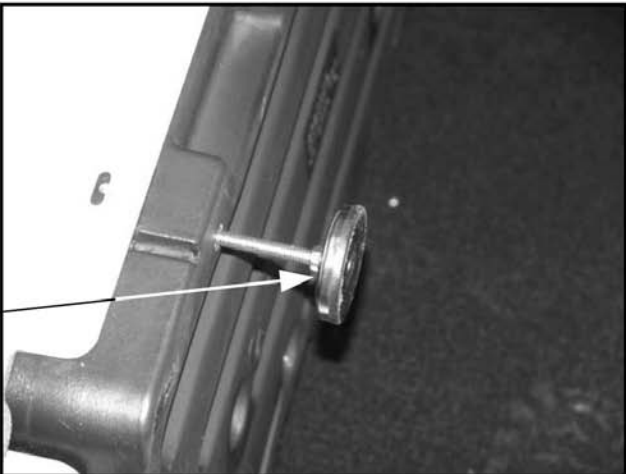

PARTIALLY SCREW IN LEVELING FEET

STEP 3: PARTIALLY SCREW IN THE LEVELING FEET AT THE FOUR LOCATIONS.

## CONDENSATE PUMP INSTALLATION: FOR HVAC INSTALLER ONLY

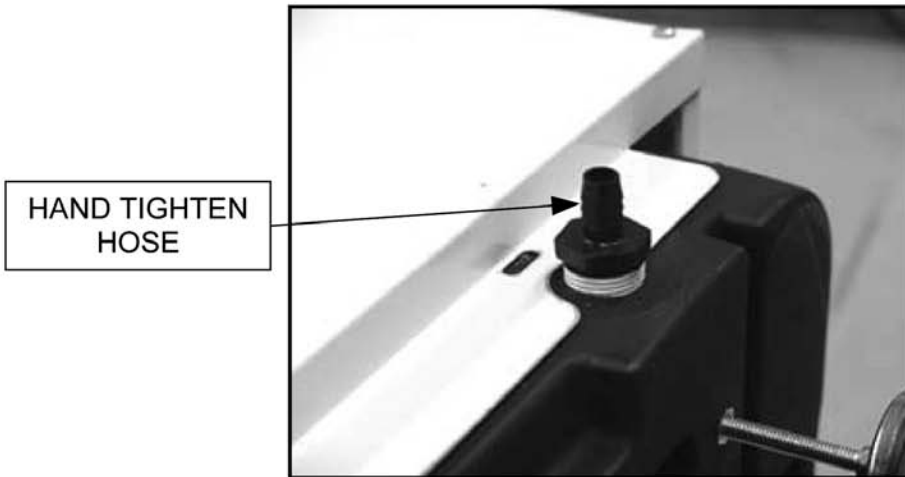

STEP 4: HAND TIGHTEN THE HOSE ADAPTOR TO GET THE THREADS STARTED. TURN CLOCKWISE.



STEP 5: USE AN ADJUSTABLE WRENCH TO FINISH TIGHTENING.

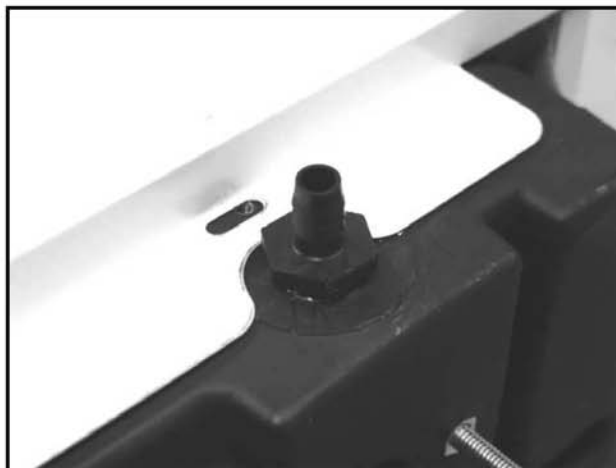

STEP 6: FULLY SEAT THE DRAIN ADAPTOR SO THAT NO LEAKS OCCUR.

## CONDENSATE PUMP INSTALLATION: FOR HVAC INSTALLER ONLY

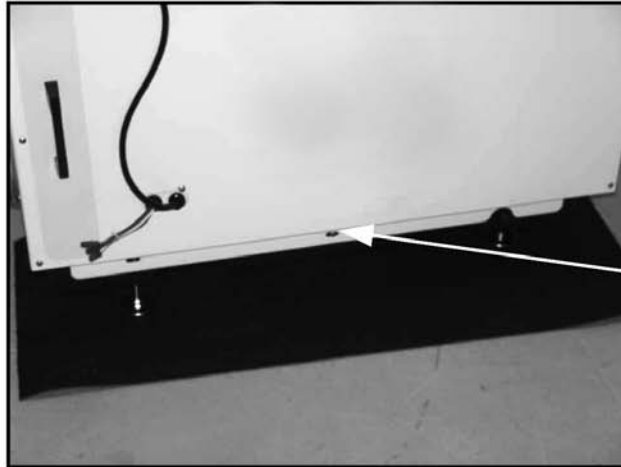

REMOVE MIDDLE  
SCREW WITH A  
PHILLIPS SCREW  
DRIVER.

STEP 7: TURN THE UNIT UPRIGHT ONTO THE LEVELING FEET AND REMOVE THE SCREW SHOWN. KEEP THIS SCREW, YOU WILL USE IT IN STEP 10.



STEP 8: PREPARE THE CONDENSATE PUMP/BRACKET ASSEMBLY.



STEP 9: POSITION THE OBLONG SLOT IN THE BRACKET WITH THE MIDDLE SCREW HOLE.

## CONDENSATE PUMP INSTALLATION: FOR HVAC INSTALLER ONLY

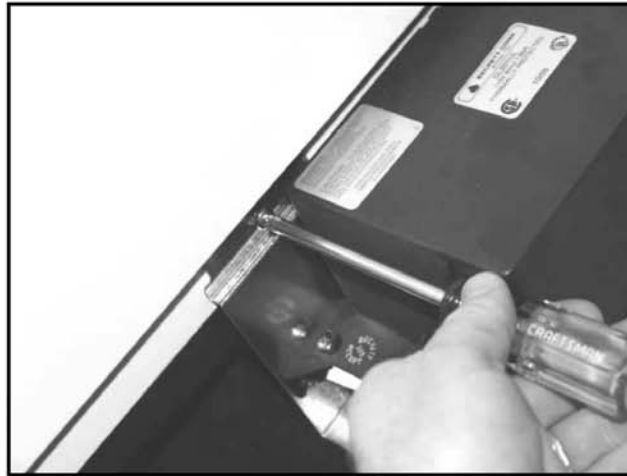

STEP 10: SECURE THE PUMP TO THE DEHUMIDIFIER WITH THE SCREW REMOVED IN STEP 7.



STEP 11: REMOVE THE HOSE/ELBOW ASSEMBLY FROM THE BAG AND INSTALL THE SHORT END ONTO THE ADAPTOR. MAKE SURE THAT THE HOSE FULLY COVERS THE ADAPTOR BARBS.

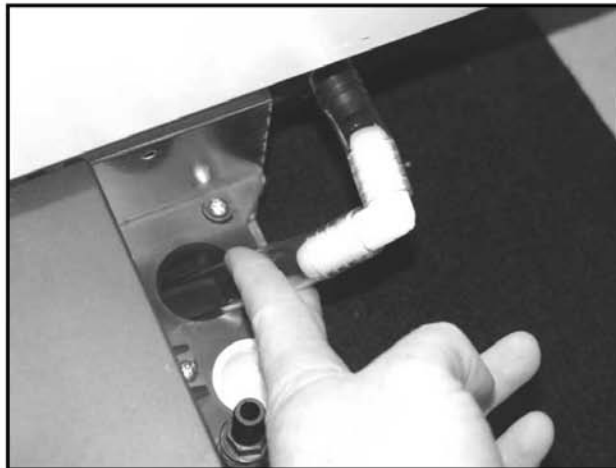

STEP 12: INSERT THE OTHER END OF THE HOSE/ELBOW ASSEMBLY INTO THE OPEN HOLE OF THE CONDENSATE PUMP.

## CONDENSATE PUMP INSTALLATION: FOR HVAC INSTALLER ONLY



STEP 13: ATTACH THE 20' DRAIN HOSE TO THE CONDENSATE PUMP AND ROUTE IT TO A FLOOR DRAIN.

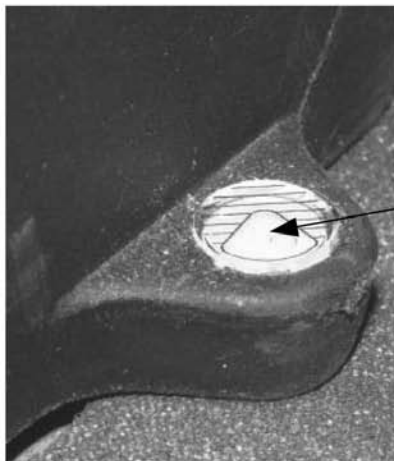

CENTER BUBBLE IN  
CLEAR AREA OF THE  
LEVEL VIAL

STEP 14: ADJUST THE HEIGHT OF THE LEVELING FEET TO MOVE THE LEVEL BUBBLE INTO THE CLEAR AREA OF THE WINDOW.

STEP 15: PLUG IN THE CONDENSATE PUMP AND THE ASSEMBLY IS COMPLETED.



# ULTRA-AIRE 90H Dehumidifier Limited Warranty

## WARRANTOR:

Therma-Stor LLC  
PO Box 8680  
Madison, WI 53708  
Telephone: 1-800-533-7533

**WARRANTY:** This warranty covers the Ultra-Aire 90H and extends only to the original residential end-user of the Ultra-Aire dehumidifier, and may not be assigned or transferred.

**Year(s) One through Two** - 100% parts and labor (all components). Therma-Stor LLC warrants that, for two (2) years the Ultra-Aire 90H dehumidifier will operate free from any defects in materials and workmanship, or Therma-Stor LLC will, at its option, repair or replace the defective part(s), free of any charge. This excludes charges incurred installing and removing the Ultra-Aire 90H for repair.

**Year(s) Three through Five** - Therma-Stor LLC further warrants for a period of five (5) years, the condenser, evaporator, and compressor of the Ultra-Aire 90H dehumidifier will operate free of any defects in material or workmanship, or Therma-Stor LLC, at its option, will repair or replace the defective part(s). This excludes charges incurred installing and removing Ultra-Aire 90H for repair.

**USER RESPONSIBILITIES:** Warranty service must be performed by a servicer authorized by Therma-Stor LLC. To obtain warranty service you must obtain a return material authorization (RMA). To obtain an RMA you must present proof of purchase or (lease), by use of a warranty card, original sales receipt or other reasonable and reliable means.

To obtain an RMA call Therma-Stor LLC at the above number and ask for the Therma-Stor LLC Service Department, which will then issue an RMA# and arrange for, at our option, either repair or replacement.

**FREIGHT:** Freight to and from the servicer is the responsibility of the end-user. The end-user is responsible for normal care and proper return packaging.

**LIMITATIONS AND EXCLUSIONS:** This warranty does not cover any defect, malfunction, etc. resulting from misuse, abuse, lack of normal care, corrosion, freezing, tampering, modification, unauthorized or improper repair or installation, accident, acts of nature or any other cause beyond Therma-Stor LLC's reasonable control. This excludes charges incurred installing and removing Ultra-Aire 90H for repair.

If any Ultra-Aire 90H part is repaired or replaced, the new part shall be warranted for the balance of original warranty (but all warranty periods will be extended by the period of time, if any, that the Ultra-Aire 90H is out of service while awaiting covered warranty service). Warranty service will be performed during normal working hours.

UPON THE EXPIRATION OF THE WRITTEN WARRANTY APPLICABLE TO THE ULTRA-AIRE DEHUMIDIFIER OR ANY PART THEREOF, ALL OTHER WARRANTIES IMPLIED BY LAW, INCLUDING MERCHANTABILITY AND FITNESS FOR A PARTICULAR PURPOSE, SHALL ALSO EXPIRE. ALL WARRANTIES MADE BY THERMA-STOR LLC ARE SET FORTH HEREIN, AND NO CLAIM MAY BE MADE AGAINST THERMA-STOR LLC BASED ON ANY ORAL WARRANTY. IN NO EVENT SHALL THERMA-STOR LLC, IN CONNECTION WITH THE SALE, INSTALLATION, USE, REPAIR OR REPLACEMENT OF ANY ULTRA-AIRE DEHUMIDIFIER OR PART THEREOF BE LIABLE UNDER ANY LEGAL THEORY FOR ANY SPECIAL, INDIRECT OR CONSEQUENTIAL DAMAGES INCLUDING WITHOUT LIMITATION WATER DAMAGE (THE END-USER SHOULD TAKE PRECAUTIONS AGAINST SAME), LOST PROFITS, DELAY, OR LOSS OF USE OR DAMAGE TO ANY REAL OR PERSONAL PROPERTY.

Some states do not allow limitations on how long an implied warranty lasts, and some do not allow the exclusion or limitation of incidental or consequential damages, so one or both of these limitation may not apply to you.

**LEGAL RIGHTS:** This warranty gives you specific legal rights, and you may also have other rights which vary from state to state.





**Therma-Stor<sup>®</sup> LLC**

PO Box 8680 • Madison, WI 53708

Phone: 608-222-5301 • Fax: 608-222-1447

Web: [www.thermastor.com](http://www.thermastor.com) • Email: [sales@thermastor.com](mailto:sales@thermastor.com)

*Information in this document is subject to change without notice. No part of this document may be reproduced or transmitted in any form or by any means, electronic or mechanical, for any purpose, without the express written permission of Therma-Stor LLC. © 2006 Therma-Stor LLC. All rights reserved.*