



website <http://www.lgservice.com>  
e-mail <http://www.lgservice.com/techsup.html>

# ROOM AIR CONDITIONER **OWNER'S MANUAL**

Please read the operating instructions and safety precautions carefully and thoroughly before installing and operating your room air conditioner.

# ACONDICIONADOR DE AIRE DE VENTANA **MANUAL DEL PROPIETARIO**

Por favor lea las instrucciones de operación y las precauciones de seguridad cuidadosa y totalmente antes de instalar y operar su acondicionador de aire de ventana.

**MODELS, MODELOS:** LT0810C  
LT1010C  
LT1030C, LT1030H  
LT1210C  
LT1230C, LT1230H

ENGLISH

ESPAÑOL

PTAC DIRECT SALES (877) 454-7822

# TABLE OF CONTENTS

<b>Safety Precautions</b> .....	3
<b>Before Operation</b> .....	7
<b>Introduction</b> .....	8
Symbols Used in this Manual .....	8
<b>Electrical Safety</b> .....	8
Temporary Use of an Adapter .....	10
Temporary Use of an Extension Cord .....	10
<b>Operating Instructions</b> .....	11
<b>Care and Maintenance</b> .....	14
<b>Installation</b> .....	15
<b>Maintenance and Service</b> .....	22
Normal Operation .....	22
Troubleshooting .....	22



## FOR YOUR RECORDS

Write the model and serial numbers here:

**Model #** \_\_\_\_\_

**Serial #** \_\_\_\_\_

You can find the numbers on a label on the side of the product.

**Dealer's Name** \_\_\_\_\_

**Date Purchased** \_\_\_\_\_

■ Staple your receipt to this page in the event you need it to prove date of purchase or for warranty issues.



## READ THIS MANUAL

Inside you will find many helpful hints on how to use and maintain your air conditioner properly. Just a little preventive care on your part can save you a great deal of time and money over the life of your air conditioner.

You'll find many answers to common problems in the chart of troubleshooting tips. If you review our chart of

**Troubleshooting Tips** first, you may not need to call for service at all.



## PRECAUTION

- **Contact an Authorized Service Center for repair or maintenance of this unit. Call 1-877-714-7486 to locate the nearest ASC.**
- **The air conditioner is not intended for use by young children or invalids without supervision.**
- **Young children should be supervised to ensure that they do not play with the air conditioner.**
- **If the power cord requires replacement, have an Authorized Servicer install an exact replacement part.**
- **Installation work must be performed in accordance with the National Electric Code by qualified and authorized personnel only.**





PTAC DIRECT SALES (877) 454-7822



# Safety Precautions

To prevent injury to the user or other people and property damage, the following instructions must be followed.

- Incorrect operation due to ignoring instructions will cause harm or damage. The seriousness is classified by the following indications.
- Because of the weight of the product, it is recommended that you have a helper to assist in the installation.

 <b>WARNING</b>	This symbol indicates the possibility of death or serious injury.
 <b>CAUTION</b>	This symbol indicates the possibility of injury or damage to properties only.

- Meanings of symbols used in this manual are as shown below.

	<b>Be sure not to do.</b>
	<b>Be sure to follow the instruction.</b>

## WARNING

### ■ Installation

**Always install the trim frame(s).**

- Improper assembly or installation may cause incorrect operation, including injury, fire, and electric shock hazards.

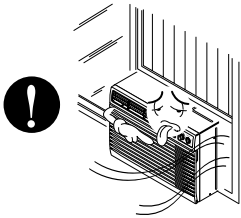

**Do not place the power cord near a heater.**

- It may cause fire and electric shock.

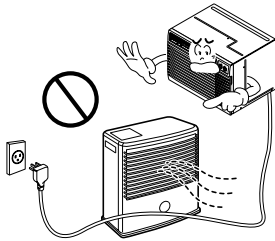

**Do not use the power cord near flammable gas or combustibles such as gasoline, benzene, thinner, etc.**

- It may cause explosion or fire.

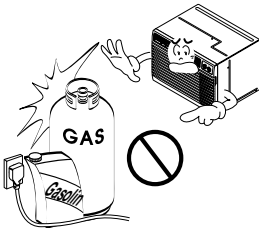

**Do not disassemble or modify products.**

- It may cause electric shock and failure.



## ■ Operation

**Plug in the power plug properly.**

- Otherwise, it will cause electric shock or fire.

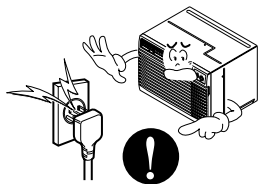

**Do not operate or stop the unit by inserting or pulling out the power plug.**

- It will cause electric shock or fire.

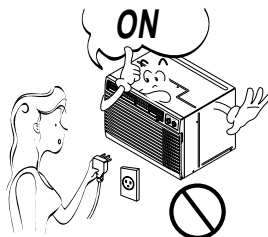

**Do not damage or use an unspecified power cord.**

- It will cause electric shock or fire.



**Do not modify power cord length.**

- It will cause electric shock or fire.

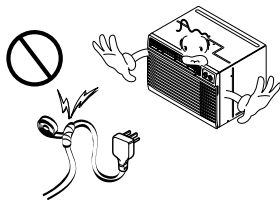

**Use the air conditioner on a single outlet circuit. (See page 7.) Do not share the outlet with other appliances.**

- It will cause electric shock or fire.

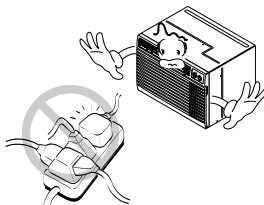

**Always plug into a grounded outlet.**

- No grounding may cause electric shock.

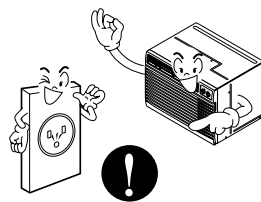

**Unplug the unit if strange sounds, odors, or smoke come from it.**

- Otherwise it will cause fire and electric shock accident.

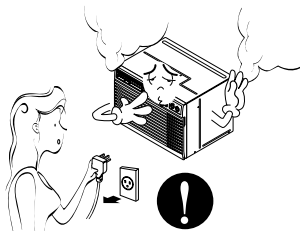

**Do not use the socket if it is loose or damaged.**

- It may cause fire and electric shock.

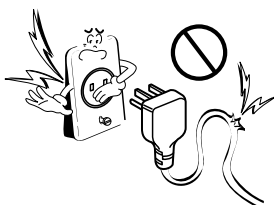

**Do not operate with wet hands or in damp environment.**

- It may cause electric shock.

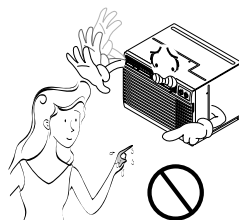

**Close all doors, windows and other outside openings to the room.**

- The air conditioner must be operated in a enclosed area to be most effective.

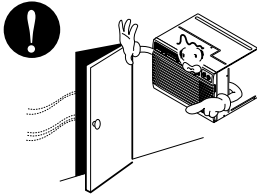

**Ventilate before operating air conditioner when gas goes out.**

- It may cause explosion, fire, and burn.

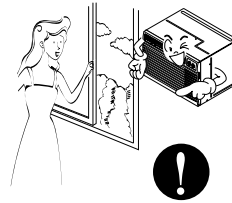

**If water enters the product, turn off the the power switch of the main body of appliance. Contact service center after taking the power-plug out from the socket.**

- It will cause electric shock or failure of machine.



**Do not clean the air conditioner with water.**

- Water may enter the unit and degrade the insulation. It may cause an electric shock.

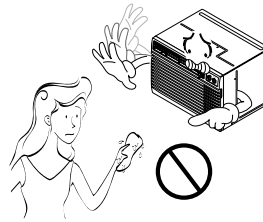

**CAUTION**

**Installation**

**Never touch the metal parts of the unit when removing the filter.**

- They are sharp and may cause injury.

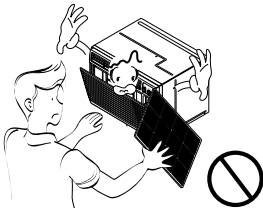

**Do not block the inlet or outlet.**

- It may cause failure of appliance or performance deteriorate.

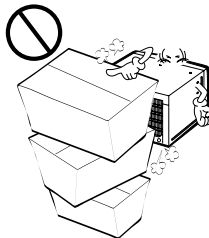

**Ensure that the outer case is not damaged by age or wear.**

- If the outer case is damaged, it must be repaired or replaced immediately. Leaving it damaged could result in the air conditioner falling out of the window, creating a safety hazard.

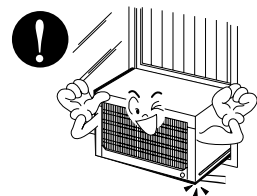

## ■ Operation

**Be cautious not to touch the sharp edges when installing.**

- It may cause injury.

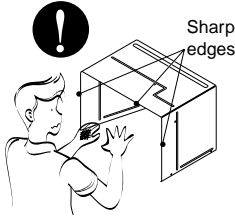

**Hold the plug by the head when taking it out.**

- It may cause electric shock and damage.

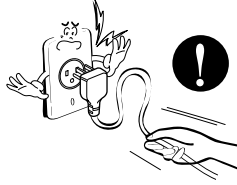

**Unplug the air conditioner if it will not be used for a long period.**

- It will waste power consumption in vain and it may cause accident.

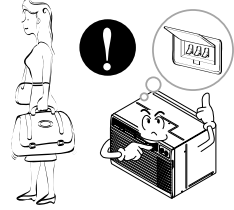

**Unplug the air conditioner before cleaning it.**

- Since the fan rotates at high speed during operation, it may cause injury.

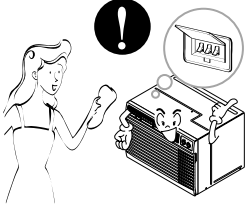

**Do not put a pet or house plant where it will be exposed to direct air flow.**

- This could injure the pet or plant.



**Do not use this appliance for special purposes such as pets, foods, precision machinery, or objects of art.**

- It is an air conditioner, not a precision refrigeration system.

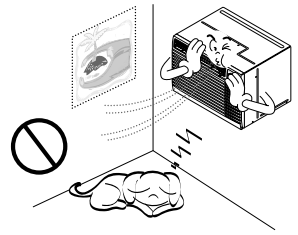

**Always insert the filter securely. Clean it every two weeks.**

- Operation without filters **will** cause failure.

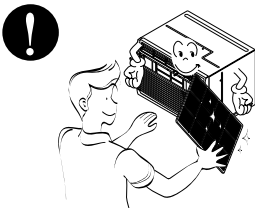

**Use a soft cloth to clean. Do not use wax, thinner, or a strong detergent.**

- The appearance of the air conditioner may deteriorate, change color, or develop surface flaws.

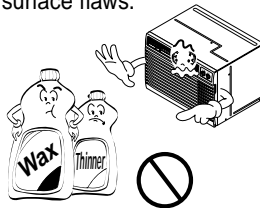

**Do not drink water drained from air conditioner. Do not direct airflow at room occupants only.**

- It is not sanitary and could cause illness or personal injury hazard.

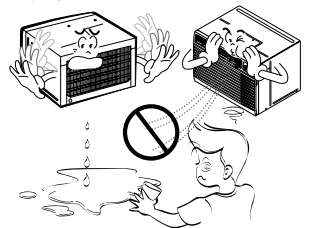

# Before Operation

## Preparing for operation

1. Plug in the power plug properly.
2. Use a dedicated circuit. Overloading the line could create a fire hazard.
3. Do not use an extension cord. See page 10 for more details.
4. Do not start/stop operation by plugging/unplugging the power cord.
5. If the power cord is damaged and requires replacement, have an Authorized Servicer install an exact replacement part.

## Usage

1. Being exposed to direct airflow for an extended period of time could be hazardous to your health. Do not expose occupants, pets, or plants to direct airflow for extended periods of time.
2. Due to the possibility of oxygen deficiency, ventilate the room when used together with stoves or other heating devices.
3. Do not use this air conditioner for non-specified special purposes (e.g. preserving precision devices, food, pets, plants, and art objects). Such usage could damage the items.
4. The air conditioner is a consumer comfort appliance, not a precision climate control system.

## Cleaning and maintenance

1. Do not touch the metal parts of the unit when removing the filter. Injuries can occur when handling sharp metal edges.
2. Do not use water to clean inside the air conditioner. Exposure to water can destroy the insulation, leading to possible electric shock.
3. When cleaning the unit, first make sure that the power and breaker are turned off. The fan rotates at a very high speed during operation. There is a possibility of injury if the unit's power is accidentally triggered on while cleaning inner parts of the unit.

## Service

For repair and maintenance, contact an Authorized Service Center. See the warranty page for details or call (800) 243-0000. Have your model number and serial number available. They should be written on page 2 of this manual.

# Introduction

## Symbols Used in this Manual



This symbol alerts you to the risk of electric shock.





This symbol alerts you to hazards that could cause harm to the air conditioner.

**Tips**

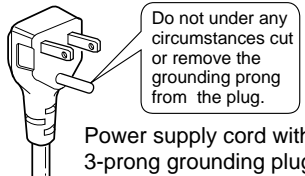

This symbol indicates special notes.

# Electrical Safety

## Electrical Data(For 115V model)

Line Cord Plug	Use Wall Receptacle	Power Supply
 <p>Power supply cord with 3-prong grounding plug</p>	<p><b>Parallel type</b></p>  <p>Standard 125V, 3-wire grounding receptacle rated 15A, 125V AC</p>	<p>Use 15 AMP time delay fuse or 15 AMP circuit breaker.</p>

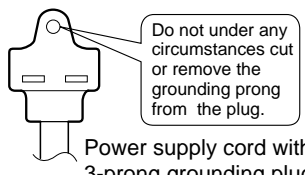
## Electrical Data(For 230/208V model)

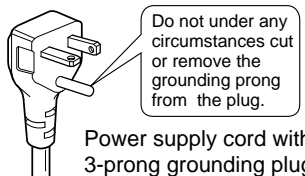
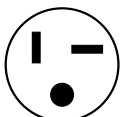
Line Cord Plug	Use Wall Receptacle	Power Supply
 <p>Power supply cord with 3-prong grounding plug</p>	<p><b>Tandem type</b></p>  <p>Standard 250V, 3-wire grounding receptacle rated 15A, 250V AC</p>	<p>Use 15 AMP time delay fuse or circuit breaker.</p>
 <p>Power supply cord with 3-prong grounding plug</p>	<p><b>Perpendicular type</b></p>  <p>Standard 250V, 3-wire grounding receptacle rated 20A, 250V AC</p>	<p>Use 20 AMP time delay fuse or circuit breaker. Refer to the nameplate for correct fusing.</p>

PTAC DIRECT SALES (877) 454-7822





**WARNING:** This appliance must be properly grounded.

The power cord of this appliance is equipped with a three-prong grounding plug. To minimize the risk of electric shock, use the plug with a standard three-slot grounding wall power outlet. If the power outlet does not include a grounding slot, have a qualified electrician replace the outlet before you use the room air conditioner.



**WARNING:** Changing the outlet without making the appropriate wiring changes will create an unsafe condition that could result in fire or electrical shock. Refer all such work to a licensed and qualified electrician.

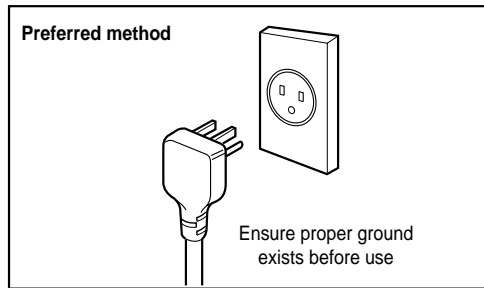

**WARNING:** Do not cut or remove the grounding prong from the power plug.



**WARNING:** Attaching the adapter ground terminal to the wall receptacle cover screw does not ground the appliance unless the cover screw is metal and not insulated, and the wall receptacle is grounded through the house wiring.



**WARNING:** If you have any doubt whether the air conditioner is properly grounded, have the wall receptacle and circuit checked by a qualified electrician.

## Temporary Use of an Adapter

We **strongly discourage** the use of an adapter due to potential safety hazards. For temporary connections, use only a UL-listed adapter, available from most local hardware stores. Ensure that the large slot in the adapter is aligned with the large slot in the receptacle for a proper polarity connection.

To disconnect the power cord from the adapter, use one hand on each to avoid damaging the ground terminal. Avoid frequently unplugging the power cord as this can lead to eventual ground terminal damage.

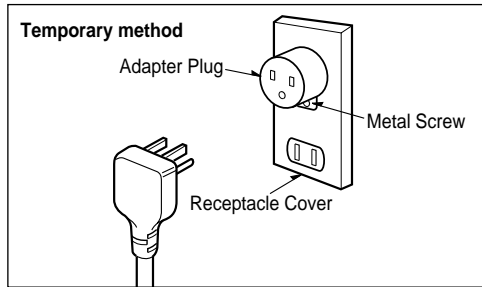

**WARNING:** Never use the appliance with a broken adapter.

## Temporary Use of an Extension Cord

We **strongly discourage** the use of an extension cord due to potential safety hazards. For temporary situations, use only CSA certified and UL listed 3-wire grounded extension cords, rated 15 A, 125 V.

# Operating Instructions

The controls will look like one of the following:

## Controls – Cooling Only

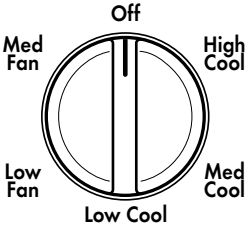
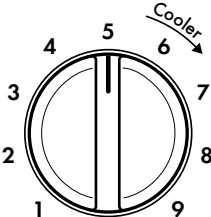
<p><b>Operation</b></p> 	<p>Off - Turns air conditioner off.          Med Fan - Med speed fan operation without cooling.          Low Fan - Low speed fan operation without cooling.          High Cool - Cooling with high speed fan operation.          Med Cool - Cooling with med speed fan operation.          Low Cool - Cooling with low speed fan operation.</p>
<p><b>Thermostat</b></p> 	<p>This automatically controls the temperature of the indoor air. Turn the knob so that arrow points to the larger marks for greater cooling. Point the arrow to the smaller marks for more moderate cooling.          (i.e. the higher number, the greater cooling)</p>

### • FOR NORMAL COOLING

1. Turn the Operation Knob to the **High Cool** from the **Low Cool** setting.
2. Set the Thermostat control to the desired temperature mark **5** (the mid-point is a good starting position). If the room temperature is not satisfactory after a reasonable time, adjust the control to a cooler or warmer setting, as appropriate.

### • FOR MAXIMUM COOLING

1. Turn the Operation Knob to the **High Cool** setting.
2. Set the Thermostat control to the largest **9** temperature mark.

### • FOR QUIETER OPERATION

1. Turn the Operation Knob to the **Low Cool** setting.
2. Set the Thermostat control as needed.

### • ENERGY SAVER (optional)

**On** : Both the fan and the compressor turn on and turn off together while operation knob is set to the Cool position.

You can get the more economical operation.

**Off** : The fan runs constantly while operation knob is set to the Cool position.

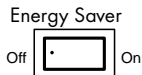

You can access the Energy Saver switch when you open the inlet grille.

The controls will look like one of the following:

**Controls – Cooling & Heating**

<p style="text-align: center;"><b>Operation</b></p>	<p>Off ( O ) : Turns the air conditioner off.                  Fan ( ⊕ ) : The low fan speed operation without cooling (heating).                  Low Cool ( * ) : Cooling with the low speed fan operation.                  High Cool ( ⊛ ) : Cooling with the high speed fan operation.                  Low Heat ( ⊛ ) : Heating with the low speed fan operation.                  High Heat ( ⊕ ) : Heating with the high speed fan operation.</p>
<p style="text-align: center;"><b>Thermostat</b></p>	<p>Turn the thermostat control to the desired setting. The central position is a normal setting for average conditions. You can change this setting, if necessary, in accordance with your temperature preference.</p> <p>The thermostat automatically controls cooling or heating, but the fan runs continuously whenever the air conditioner is in operation. If the room is too warm, turn the thermostat control clockwise. If the room is too cool, turn the thermostat control counterclockwise.</p>

**• THE AIR CONDITIONER**

This automatically controls the temperature of the indoor air.  
 The compressor will turn on and off to keep the room at the setting temperature.  
 In the heating operation, the electric heater will turn on and off to keep the room at the setting temperature.

**• HEAT PUMP MODELS**

When the outdoor temperature is lower than -4°C (24°F), the electric heater will turn on instead of the heat pump.



**CAUTION:** When the air conditioner has been performed its cooling or heating operation and is turned off or set to the fan position, wait at least 3 minutes before resetting to the cooling operation again.

A slight heat odor may come from the unit when first switching to HEAT after the cooling season is over. This odor, caused by fine dust particles on the heater, will disappear quickly. This is harmless.

*Additional controls and important information.***Ventilation**

The ventilation lever is located in the right of the air discharge. The ventilation lever must be in the CLOSE position in order to maintain the best cooling conditions. When fresh air is necessary in the room, set the ventilation lever to the OPEN position. The damper is opened and room air is exhausted outside.

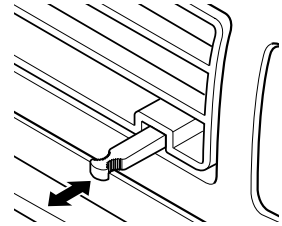
**PULL OPEN / PUSH CLOSE****Air Direction**

The direction of air can be controlled wherever you want by adjusting the horizontal louver and the vertical louver.

**• HORIZONTAL AIR-DIRECTION CONTROL**

The horizontal air direction is adjusted by moving vertical louver. The lever of vertical louver is located in the right and left side of the air discharge.

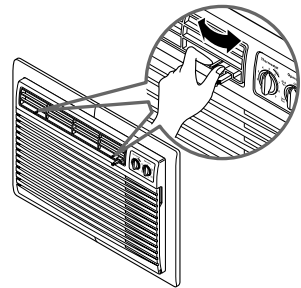
**• VERTICAL AIR-DIRECTION CONTROL**

The vertical air direction is adjusted by moving the horizontal louver.

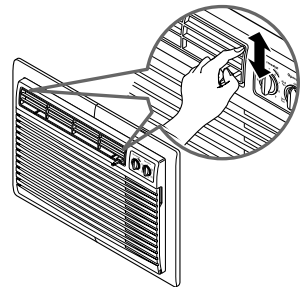

# Care and Maintenance

TURN THE AIR CONDITIONER OFF AND REMOVE THE PLUG FROM THE POWER OUTLET.

## Air Filter Cleaning

The air filter should be checked at least twice a month to see if cleaning is necessary. Trapped particles in the filter will build up and block the airflow. This reduces the cooling capacity and also causes an accumulation of frost on the cooling coils.

If the filter becomes torn or damaged you should replace immediately. Replacement filters are available from your salesperson, dealer, and the authorized customer service centers.

1. Open the inlet grille downward by pulling out the top of the inlet grille.
2. Remove the air filter from the front grille assembly by pulling the air filter up slightly.
3. Wash the filter using lukewarm water below 40°C (104°F).
4. Gently shake the excess water from the filter completely. Replace the filter.

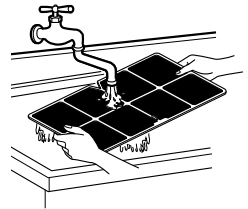
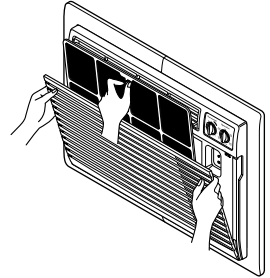

## How to Attach Front Grille to Cabinet

The front grille can be removed for cleaning or to check the model and serial numbers. For your safety, you should attach the front grille as the following procedures.

1. Pull down front grille from the cabinet top.
2. Push front grille's tips toward the cabinet in order to insert front grille's tabs into the cabinet.
3. Open the inlet grille.
4. Tighten the screw through the front grille into the plate of control box.
5. Close inlet grille.

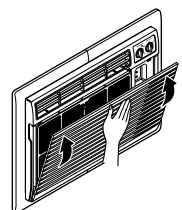
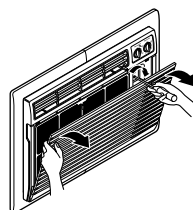
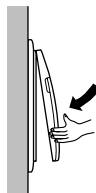
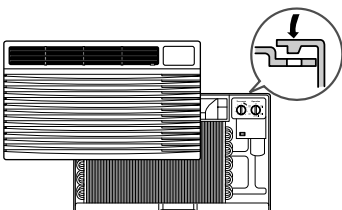

# Installation

Remove packing sheet from the back of the sleeve, and packing corner and blue tape from the air conditioner.

## INSTALLATION REQUIREMENTS

If you use an existing wall sleeve, you should measure its dimensions.

Install the new air conditioner according to these installation instructions to achieve the best performance. All wall sleeves used to mount the new air conditioner must be in good structural condition and have a rear grille to securely attach the new air conditioner. (FIG. 1)

With the LGE sleeve, you can maintain the best performance of the new air conditioner. (FIG. 2)

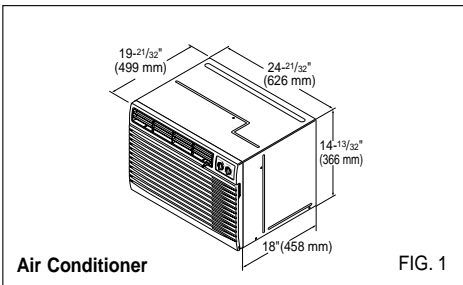

Air Conditioner

FIG. 1

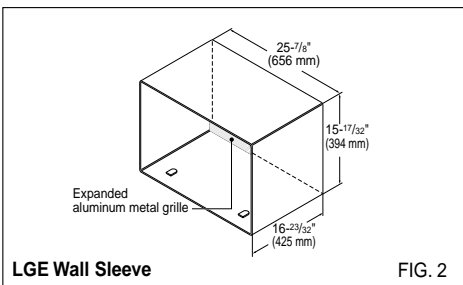

LGE Wall Sleeve

FIG. 2

## ELECTRICAL SERVICE

Check your available electrical service. The power supply available must be the same as that shown on the unit nameplate (found on left side of cabinet).

All models are equipped with a 3-prong service plug to provide proper service and safe positive grounding. Do not change plug in any way. Do not use an adapter plug. If your present wall outlet does not match your plug, call a qualified electrician to make the necessary corrections. SAVE CARTON for storage and this OWNER'S MANUAL for future reference. The carton is the best way to store unit during winter or when not in use.

## INSTALLATION HARDWARE

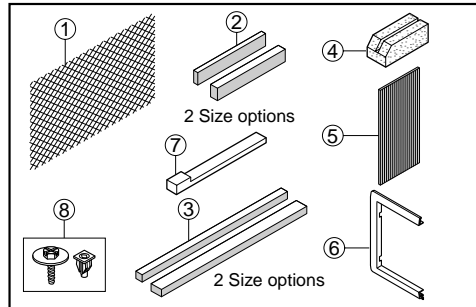

ITEM	NAME OF PARTS	Q'TY
①	PLASTIC GRILLE	1
②	HORIZONTAL INSULATION STRIPS	2
③	AROUND INSULATION STRIPS	2
④	SUPPORT BLOCK	2
⑤	BAFFLE	1
⑥	TRIM FRAME	2
⑦	SHIM	2
⑧	PLASTIC NUTS AND WASHER SCREWS	4

**⚠ CAUTION:** To avoid risk of personal injury, property damage, or product damage due to the weight of this device and sharp edges that may be exposed:

- Air conditioners covered in this manual pose an excessive weight hazard. Two or more people are needed to move and install the unit. To prevent injury or strain, use proper lifting and carrying techniques when moving unit.
- Carefully inspect location where air conditioner will be installed. Be sure it will support the weight of the unit over an extended period of time.
- Handle air conditioner with care. Wear protective gloves whenever lifting or carrying the unit. AVOID the sharp metal fins of front and rear coils.
- Make sure air conditioner does not fall during installation.

## REQUIRED TOOLS:

- Tight Fitting gloves
- Standard screwdriver
- Phillips screwdriver
- Pliers
- Sharp knife
- 3/8-inch open end wrench or adjustable wrench
- 1/4-inch hex socket and ratchet
- Tape measure
- Electric drill
- 1/4-inch drill bit

# INSTALLATION

**CAUTION:** We strongly recommend the removal of the old wall sleeve and the installation of a new LGE Wall Sleeve.

If you decide to keep the existing wall sleeve, you have to redirect the louvers at the back of the wall sleeve illustration. The use of pliers is recommended. If you DO NOT redirect, you run the risk of poor performance or product failure. This is not covered under the terms of the LGE warranty.

- Pick a location which will allow the conditioned air to blow into the area you want. Good installation with special attention to the proper position of the unit will lessen the chance that service will be needed.

## ITEMS IN INSTALLATION HARDWARE

You may not need all parts in the kit. Discard unused parts

ITEM (inches)		Qty.
Plastic grille	26 <sup>3</sup> / <sub>4</sub> x 16 <sup>1</sup> / <sub>2</sub>	1
Horizontal Insulation Strips	1 <sup>3</sup> / <sub>8</sub> x 5 <sup>5</sup> / <sub>8</sub> x 27 <sup>3</sup> / <sub>16</sub>	1
	1 <sup>3</sup> / <sub>8</sub> x 1 <sup>3</sup> / <sub>8</sub> x 27 <sup>3</sup> / <sub>16</sub>	1
Around Insulation Strips	1 <sup>3</sup> / <sub>8</sub> x 3 <sup>3</sup> / <sub>4</sub> x 61 <sup>1</sup> / <sub>2</sub>	1
	1 <sup>3</sup> / <sub>8</sub> x 1 <sup>3</sup> / <sub>8</sub> x 61 <sup>1</sup> / <sub>2</sub>	1
Support Block	1 <sup>3</sup> / <sub>4</sub> x 1 <sup>3</sup> / <sub>8</sub> x 4 <sup>5</sup> / <sub>16</sub>	2
Baffle	14 x 4 <sup>1</sup> / <sub>2</sub> x 1 <sup>1</sup> / <sub>8</sub>	1
Shim	13 x 1 x 3 <sup>3</sup> / <sub>4</sub>	2
Trim Frame		2
Washer Screw		4
Nuts(Plastic)		4

## HOW TO INSTALL

- 1 Identify the existing wall sleeve before installing the unit from the listed below.

Brand	Wall Sleeve Dimensions (inches)		
	Width	Height	Depth
White-Westinghouse Frigidaire Carrier (52F series)	25-1/2	15-1/4	16, 17-1/2 or 22
General Electric /Hotpoint	26	15-5/8	16-7/8
Whirlpool	25-7/8	16-1/2	17-1/8 or 23
Fedders/Emerson	27	16-3/4	16-3/4 or 19-3/4
LGE	25-7/8	15-17/32	16-23/32
Emerson/Fedders	26-3/4	15-3/4	15
Carrier (51S Series)	25-3/4	16-7/8	18-5/8
Friedrich	27	16-3/4	16-3/4

**Tips** All wall sleeves used to mount the new Air Conditioner must be in sound structural condition and have a rear grille that securely attaches to sleeve, or rear flange that serves as a stop for the Air Conditioner,

- 2 Remove old air conditioner from existing wall sleeve.
- 3 Clean the interior of an existing sleeve. (Do not disturb seals.)
- 4 Wall sleeve must be securely fastened in wall before installing the air conditioner. Use the nails or screws through sleeve into wall, if needed. Repaint sleeve if needed.
- 5 Prepare the wall sleeve for installation of the unit. If you plan to use your existing wall sleeve, and it is not LGE, use procedure B or C below.

Procedure	Brand	Depth(inches)
A	LGE	16-23/32
B	White-Westinghouse Frigidaire Carrier (52F series)	16, 17-1/2 or 22
	General Electric /Hotpoint	16-7/8
	Whirlpool Carrier (51S series)	17-1/8 or 23
C	Fedders/Emerson	18-5/8 or 19-3/4
	Emerson/Fedders	15
	Friedrich	16-3/4

- 6 Install new unit into wall sleeve.

**CAUTION:** When installation is completed, replacement unit MUST have a rearward slope as shown.

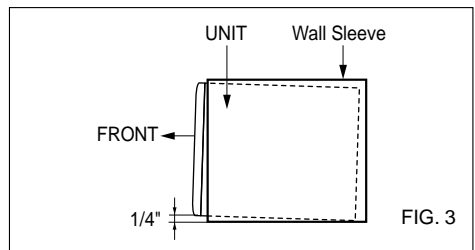



## PROCEDURE A

- 1** If you are using the new sleeve supplied with your unit, skip to step 3. Otherwise, install the plastic grille from the kit. Cut the plastic grille to 25-1/2" wide and 15-1/4" high. Place the plastic grille to the inside of the wall sleeve at the rear flange.

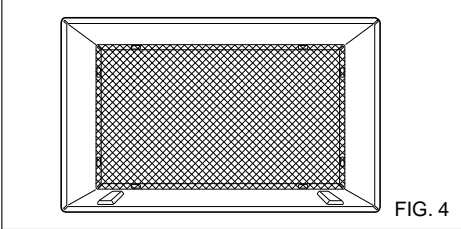

FIG. 4

- 2** Fasten the 4 washer screws to secure the grille to the wall sleeve. If you need plastic nuts to mount plastic grille to the inside of the wall sleeve, there are plastic nuts in the installation kit. The nuts are installed from the inside of the sleeve and are pressed into the square holes of the rear flanges.

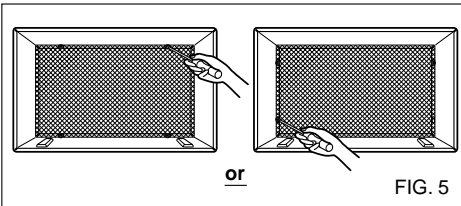

FIG. 5

- 3** Remove the backing from the Horizontal Insulation strip  $1\frac{3}{8} \times \frac{3}{8} \times 27\frac{3}{16}$  and attach that to the inside bottom of the sleeve as shown below. Remove the backing from the Around Insulation strip  $1\frac{3}{8} \times \frac{3}{4} \times 61\frac{1}{2}$  and attach that to the inside front of the sleeve as shown below.

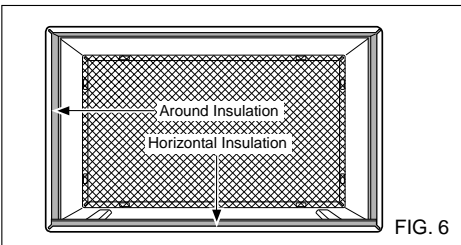

FIG. 6

- 4** Install the new unit into the wall sleeve.
- 5** To assemble trim, snap the tab of each piece into the slot of the other piece as shown below. Slide trim over the front of the air conditioner until trim is flush with sleeve as shown below.

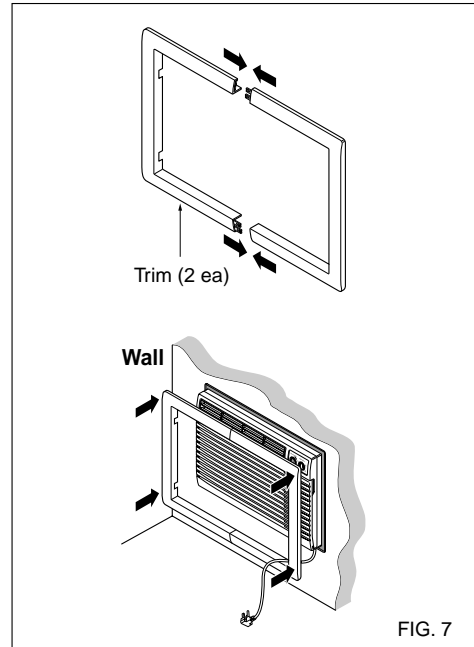

FIG. 7

### ⚠ CAUTION

- Air conditioners covered in this manual pose an excessive weight hazard. Two or more people are needed to move and install the unit. To prevent injury or strain, use proper lifting and carrying techniques when moving unit.
- When handling the air conditioner, be careful to avoid cuts from sharp metal fins on front and rear coils.
- Make sure air conditioner does not fall during removal.

## PROCEDURE B

- 1 Redirect the louvers at the back of the wall sleeve to 60° angle as shown in the FIG 8. The use of pliers is recommended.

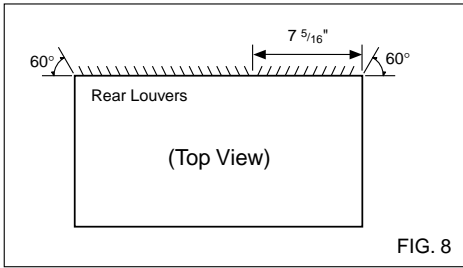

- 2 If the wall sleeve already has a rear grille, skip to step 4. If the wall sleeve does not have a rear grille or louvered panel, install the plastic grille from the kit. Cut the plastic grille to 25-1/2" wide and 15-1/4" high. Place the plastic grille to the inside of the wall sleeve at the rear flange.

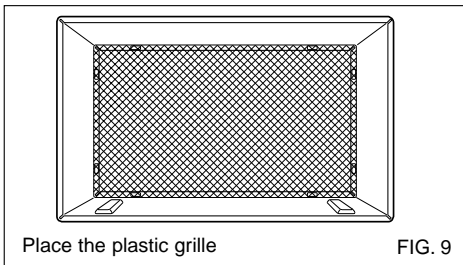

- 3 Fasten the 4 washer screws to secure the grille to the wall sleeve. If you need plastic nuts to mount plastic grille to the inside of the wall sleeve, there are plastic nuts in the installation kit. The nuts are installed from the inside of the sleeve and are pressed into the square holes of the rear flanges.

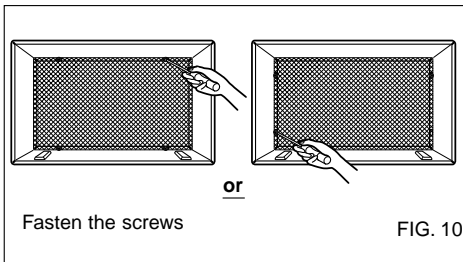

- 4 Remove the backing from the Horizontal Insulation strip 1 3/8 x 5/8 x 27 3/16 and attach that to the inside bottom of the sleeve as shown below. Remove the backing from the Around Insulation strip 1 3/8 x 3/4 x 61 1/2 and attach that to the inside front of the sleeve as shown below.

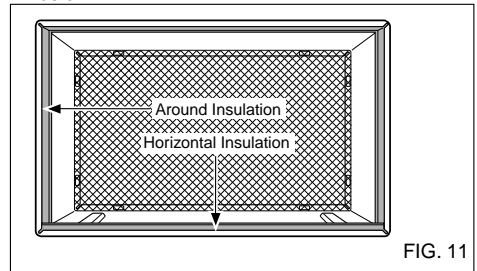

- 5 If the depth of your existing wall sleeve is less than or equal to 18", skip to step 7. Otherwise, cut the baffles and the support blocks according to length "A" in the table below.

Depth "D" of the existing wall sleeve (inches)	Length "A" (inches)	
18 < D ≤ 18-5/8	3/4	<p>Support Block</p> <p>Baffle</p> <p>FIG. 12</p>
18-5/8 < D ≤ 19-3/4	1-3/4	
19-3/4 < D ≤ 22	4	

- 6 Remove the backing from the support blocks and attach them to the inside of the wall sleeve as shown FIG 9. Slide the baffle into slots of the support blocks.

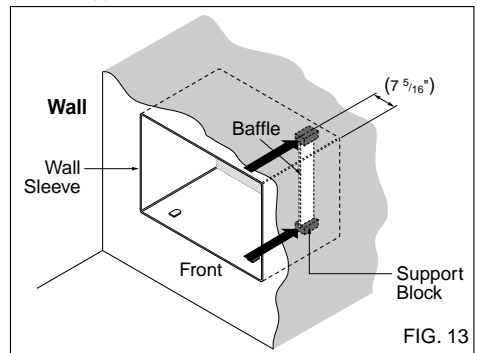

- 7 Install the new unit into the wall sleeve.

## PROCEDURE B

- 8** To assemble trim, snap the tab of each piece into the slot of the other piece as shown below. Slide trim over the front of the air conditioner until trim is flush with sleeve as shown below.

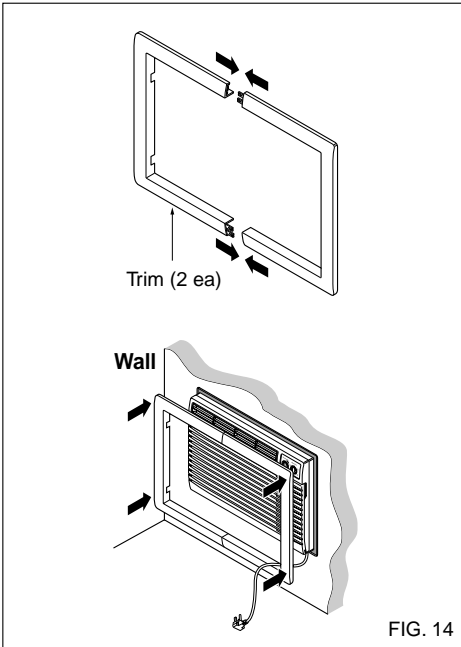

### **!** CAUTION

- Air conditioners covered in this manual pose an excessive weight hazard. Two or more people are needed to move and install the unit. To prevent injury or strain, use proper lifting and carrying techniques when moving unit.
- When handling the air conditioner, be careful to avoid cuts from sharp metal fins on front and rear coils.
- Make sure air conditioner does not fall during removal.

## PROCEDURE C

- 1 Redirect the louvers at the back of the wall sleeve to 60° angle as shown in the FIG 15. The use of pliers is recommended.

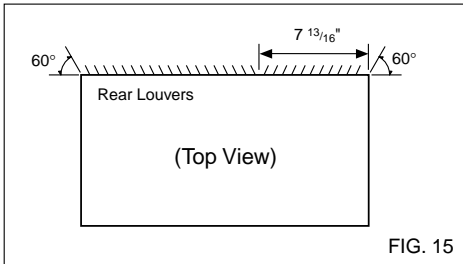

- 2 If the wall sleeve already has a rear grille, skip to step 4. If the wall sleeve does not have a rear grille or louvered panel, install the plastic grille from the kit. Cut the plastic grille to 26-1/2" wide and 15-1/2" high. Place the plastic grille to the inside of the wall sleeve at the rear flange.

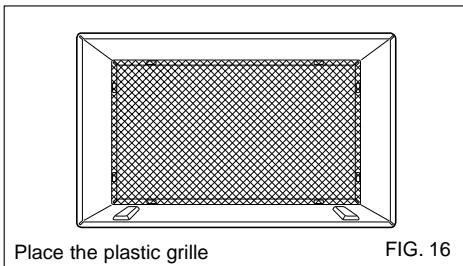

- 3 Fasten the 4 washer screws to secure the grille to the wall sleeve. If you need plastic nuts to mount plastic grille to the inside of the wall sleeve, there are plastic nuts in the installation kit. The nuts are installed from the inside of the sleeve and are pressed into the square holes of the rear flanges.

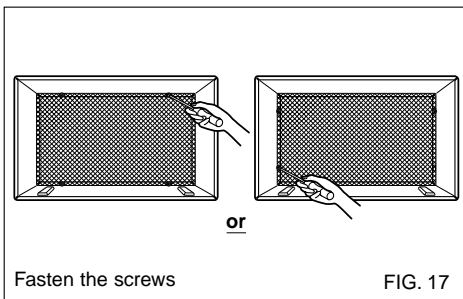

- 4 Remove the backing from the Horizontal Insulation strip 1 3/8 x 1 3/8 x 27 3/16 and attach that to the inside bottom of the sleeve as shown below. Remove the backing from the Around Insulation strip 1 3/8 x 1 3/8 x 61 1/2 and attach that to the inside front of the sleeve as shown below.

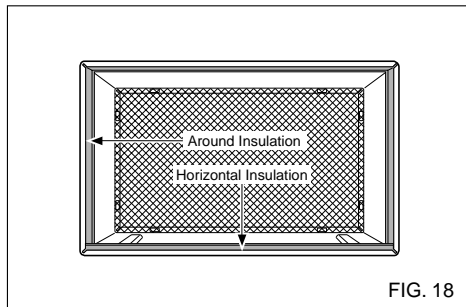

- 5 If the depth of your existing sleeve is less than or equal to 18", skip to step 7. Otherwise, cut the baffles and the support blocks according to Length "A" in the table below.

Depth "D" of the existing wall sleeve (inches)	Length "A" (inches)
$18 < D \leq 18\text{-}5/8$	$3/4$
$18\text{-}5/8 < D \leq 19\text{-}3/4$	$1\text{-}3/4$
$19\text{-}3/4 < D \leq 22$	4

FIG. 19

- 6 Remove the backing from the support blocks and attach them to the inside of the wall sleeve as shown FIG 20. Slide the baffle into slots of the support blocks

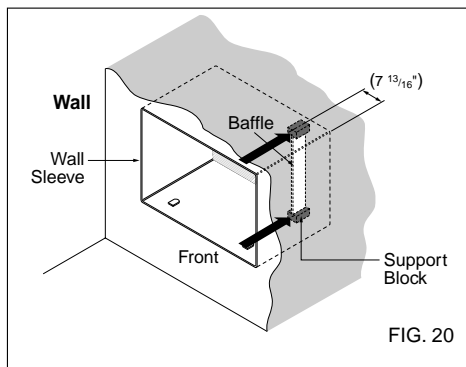

PTAC DIRECT SALES (877) 454-7822

## PROCEDURE C

- 7** Remove the backing from the 13" shim strips and attach them as shown below in Fig. 22. The higher portion of shim is to be placed in front of the rib on the base of wall sleeve.

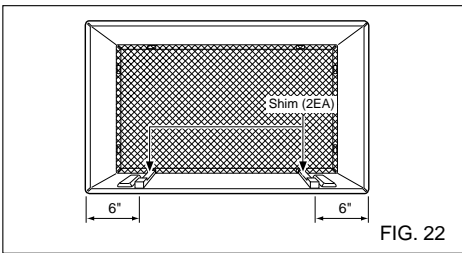
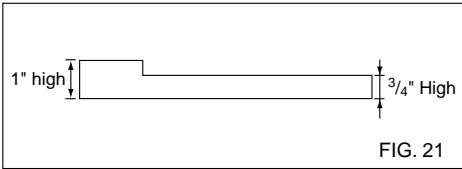

- 8** Install the new unit into the wall sleeve

- 9** To assemble trim, snap the tab of each piece into the slot of the other piece as shown below. Slide trim over the front of the air conditioner until trim is flush with sleeve as shown below.

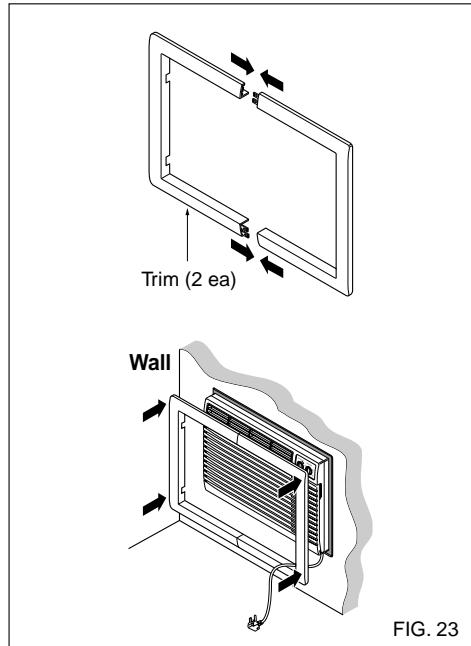

### **!** CAUTION

- Air conditioners covered in this manual pose an excessive weight hazard. Two or more people are needed to move and install the unit. To prevent injury or strain, use proper lifting and carrying techniques when moving unit.
- When handling the air conditioner, be careful to avoid cuts from sharp metal fins on front and rear coils.
- Make sure air conditioner does not fall during removal.

# Maintenance and Service

*Troubleshooting Tips Save time and money!*

*Review the chart below first and you may not need to call for service.*

## Normal Operation

- You may hear a pinging noise caused by water being picked up and thrown against the condenser on rainy days or when the humidity is high. This design feature helps remove moisture and improve efficiency.
- You may hear the thermostat click when the compressor cycles on and off.
- Water will collect in the base pan during high humidity or on rainy days. The water may overflow and drip from the outdoor side of the unit.
- The fan may run even when the compressor does not.

## Troubleshooting

Problem	Possible Causes	What To Do
<b>Air conditioner does not start</b>	■ <i>The air conditioner is unplugged.</i>	• Make sure the air conditioner plug is pushed completely into the outlet.
	■ <i>The fuse is blown/circuit breaker is tripped.</i>	• Check the house fuse/circuit breaker box and replace the fuse or reset the breaker.
	■ <i>Power failure.</i>	• If power failure occurs, turn the mode control to <b>OFF</b> . When power is restored, wait 3 minutes to restart the air conditioner to prevent tripping of the
<b>Air conditioner does not cool as it should</b>	■ <i>Airflow is restricted.</i>	• Make sure there are no curtains, blinds, or furniture blocking the front of the air conditioner.
	■ <i>The THERMOSTAT may not be set high enough.</i>	• Turn the knob to a higher number. The highest setting provides maximum cooling.
	■ <i>The air filter is dirty.</i>	• Clean the filter at least every 2 weeks. See the operating instructions section.
	■ <i>The room may have been hot.</i>	• When the air conditioner is first turned on, you need to allow time for the room to cool down.
	■ <i>Cold air is escaping.</i>	• Check for open furnace floor registers and cold air returns. • Set the air conditioner's vent to the closed position.
	■ <i>Cooling coils have iced up.</i>	• See Air Conditioner Freezing Up below.
<b>Air conditioner freezing up</b>	■ <i>Ice blocks the air flow and stops the air conditioner from cooling the room.</i>	• Set the mode control at <b>Med Fan</b> or <b>High Cool</b> with the thermostat at <b>1</b> or <b>2</b> .

PTAC DIRECT SALES (877) 454-7822

