



OM-222 166K

2007-11

Processes

Induction Heating

Description



Induction Heating Power Source

CE

ProHeat 35

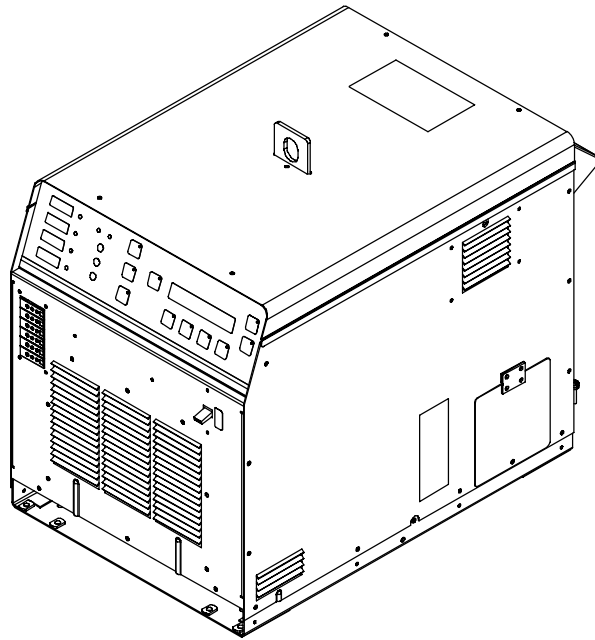

Visit our website at
www.MillerWelds.com

OWNER'S MANUAL

File: Induction Heating

From Miller to You

Thank you and congratulations on choosing Miller. Now you can get the job done and get it done right. We know you don't have time to do it any other way.

That's why when Niels Miller first started building arc welders in 1929, he made sure his products offered long-lasting value and superior quality. Like you, his customers couldn't afford anything less. Miller products had to be more than the best they could be. They had to be the best you could buy.

Today, the people that build and sell Miller products continue the tradition. They're just as committed to providing equipment and service that meets the high standards of quality and value established in 1929.

This Owner's Manual is designed to help you get the most out of your Miller products. Please take time to read the Safety precautions. They will help you protect yourself against potential hazards on the worksite.

We've made installation and operation quick and easy. With Miller you can count on years of reliable service with proper maintenance. And if for some reason the unit needs repair, there's a Troubleshooting section that will help you figure out what the problem is. The parts list will then help you to decide the exact part you may need to fix the problem. Warranty and service information for your particular model are also provided.



Miller is the first welding equipment manufacturer in the U.S.A. to be registered to the ISO 9001:2000 Quality System Standard.

Miller Electric manufactures a full line of welders and welding related equipment. For information on other quality Miller products, contact your local Miller distributor to receive the latest full line catalog or individual specification sheets. **To locate your nearest distributor or service agency call 1-800-4-A-Miller, or visit us at www.MillerWelds.com on the web.**



Working as hard as you do – every power source from Miller is backed by the most hassle-free warranty in the business.



TABLE OF CONTENTS

SECTION 1 – SAFETY PRECAUTIONS – READ BEFORE USING	1
1-1. Symbol Usage	1
1-2. Induction Heating Hazards	1
1-3. Additional Symbols for Installation, Operation, and Maintenance	2
1-4. California Proposition 65 Warnings	2
1-5. Principal Safety Standards	3
1-6. EMF Information	3
SECTION 2 – CONSIGNES DE SÉCURITÉ – LIRE AVANT UTILISATION	4
2-1. Signification des symboles	4
2-2. Dangers relatifs au soudage à l'arc	4
2-3. Dangers supplémentaires en relation avec l'installation, le fonctionnement et la maintenance	5
2-4. Proposition californienne 65 Avertissements	6
2-5. Principales normes de sécurité	6
2-6. Information EMF	6
SECTION 3 – DEFINITIONS	7
3-1. Warning Label Definitions	7
3-2. Warning Label Definitions (Continued)	8
3-3. Rating Label For CE Products	9
3-4. WEEE Label (For Products Sold Within The EU)	9
3-5. Symbols And Definitions	10
SECTION 4 – INSTALLATION	10
4-1. Specifications	10
4-2. Selecting A Location	11
4-3. Tipping	11
4-4. Electrical Service Guide	12
4-5. Connecting 3-Phase Input Power For 460/575 Volt Models	13
4-6. Connecting 3-Phase Input Power For 400/460 Volt Models	14
4-7. Power Source Output Connections	15
4-8. Remote 14 Receptacle RC14 Information and Connections	16
4-9. Remote 14 Socket Information	16
4-10. Temperature Recorder Receptacle RC9 Information And Connections	17
4-11. Temperature Recorder Socket Information	17
4-12. Secondary Insulation Protection	18
4-13. 115 Volt AC Duplex Receptacle And Supplementary Protector	19
4-14. Locating Thermocouples	19
4-15. Attaching Welded Thermocouples	21
4-16. Using Contact Thermocouples	22
4-17. Placing Temperature Probe	22
SECTION 5 – COMPONENTS AND CONTROLS	23
5-1. Controls	23
SECTION 6 – SETUP AND OPERATION	24
6-1. Safety Equipment	24
6-2. System Description	24
6-3. Power Source/System Setup	24
6-4. Programming	26
6-4-1. Temperature-Based Control	26
6-4-1-1. Preheat	26
6-4-1-2. Bake-Out	27
6-4-1-3. PWHT (Post-Weld Heat Treat)	27
6-4-1-4. Custom Program	28
6-4-2. Manual Control	32

TABLE OF CONTENTS

6-5. Run Status	33
6-5-1. Temperature Based Control	33
6-5-1-1. Preheat, Bake-Out And PWHT Run Status Screen	33
6-5-1-2. Custom Program	33
6-5-2. Manual Control	34
6-6. Parameters	34
6-7. Cooler	34
6-8. Real-Time Operation	35
6-9. System Operating Characteristics	37
SECTION 7 – MAINTENANCE	38
7-1. Routine Maintenance	38
7-2. Blowing Out Inside Of Unit	38
SECTION 8 – SAFETY PRECAUTIONS FOR SERVICING	39
8-1. Symbol Usage	39
8-2. Servicing Hazards	39
8-3. California Proposition 65 Warnings	40
8-4. EMF Information	40
SECTION 9 – DIAGNOSTICS & TROUBLESHOOTING	41
9-1. Operator Interface Indicators	41
9-2. Limit Conditions	42
9-3. Limit Condition Codes	42
9-4. Fault Conditions	43
9-5. Fault Condition Codes	43
9-6. System Diagnostic Screens	44
9-7. Removing Wrapper and Measuring Input Capacitor Voltage	46
SECTION 10 – ELECTRICAL DIAGRAM	48
SECTION 11 – PARTS LIST	50
WARRANTY	

Declaration of Conformity for European Community (CE) Products

 This information is provided for units with CE certification (see rating label on unit).

Manufacturer:

Miller Electric Mfg. Co.
1635 W. Spencer St.
Appleton, WI 54914 USA
Phone: (920) 734-9821

European Contact:

Mr. Danilo Fedolfi,
Managing Director
ITW Welding Products Italy S.r.l.
Via Privata Iseo 6/E
20098 San Giuliano
Milanese, Italy
Phone: 39(02)98290-1
Fax: 39(02)98290203

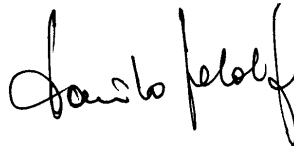

European Contact Signature: _____

Declares that this product:

ProHeat 35

conforms to the following Directives and Standards:

Directives

Low Voltage Directive: 73/23/EEC

Electromagnetic Compatibility Directives: 89/336/EEC, 92/31/EEC

Machinery Directives: 98/37/EEC, 91/368/EEC, 92/31/EEC, 133/04, 93/68/EEC

Standards

Degrees of Protection Provided By Enclosures (IP Code): IEC 60529 Ed. 2.1

Insulation Coordination For Equipment Within Low-Voltage Systems:
Part 1: Principles, Requirements And Tests, IEC 60664-1 Ed. 1.1

The product technical file is maintained by the responsible Business Unit(s) located at the manufacturing facility.

SECTION 1 – SAFETY PRECAUTIONS – READ BEFORE USING

ihom_2007-04

 Protect yourself and others from injury — read and follow these precautions.

1-1. Symbol Usage

 **DANGER!** – Indicates a hazardous situation which, if not avoided, will result in death or serious injury. The possible hazards are shown in the adjoining symbols or explained in the text.

 Indicates a hazardous situation which, if not avoided, could result in death or serious injury. The possible hazards are shown in the adjoining symbols or explained in the text.

NOTICE – Indicates statements not related to personal injury.

1-2. Induction Heating Hazards

 The symbols shown below are used throughout this manual to call attention to and identify possible hazards. When you see the symbol, watch out, and follow the related instructions to avoid the hazard. The safety information given below is only a summary of the more complete safety information found in the Safety Standards listed in Section 1-5. Read and follow all Safety Standards.

 Only qualified persons should install, operate, maintain, and repair this unit.

 During operation, keep everybody, especially children, away.



ELECTRIC SHOCK can kill.

Touching live electrical parts can cause fatal shocks or severe burns. The power circuit and output bus bars or connections are electrically live whenever the output is on. The input power circuit and machine internal circuits are also live when power is on. Incorrectly installed or improperly grounded equipment is a hazard.

- Do not touch live electrical parts.
- Enclose any connecting bus bars and coolant fittings to prevent unintentional contact.
- Wear dry, hole-free insulating gloves and body protection.
- Insulate yourself from work and ground using dry insulating mats or covers big enough to prevent any physical contact with the work or ground.
- Additional safety precautions are required when any of the following electrically hazardous conditions are present: in damp locations or while wearing wet clothing; on metal structures such as floors, gratings, or scaffolds; when in cramped positions such as sitting, kneeling, or lying; or when there is a high risk of unavoidable or accidental contact with the workpiece or ground. For these conditions, see ANSI Z49.1 listed in Safety Standards. And, do not work alone!
- Disconnect input power before installing or servicing this equipment. Lockout/tagout input power according to OSHA 29 CFR 1910.147 (see Safety Standards).
- Use only nonconductive coolant hoses with a minimum length of 18 inches (457 mm) to provide isolation.
- Properly install and ground this equipment according to its Owner's Manual and national, state, and local codes.
- Always verify the supply ground – check and be sure that input power cord ground wire is properly connected to ground terminal in disconnect box or that cord plug is connected to a properly grounded receptacle outlet.

 Indicates special instructions.



This group of symbols means Warning! Watch Out! ELECTRIC SHOCK, MOVING PARTS, and HOT PARTS hazards. Consult symbols and related instructions below for necessary actions to avoid the hazards.

- When making input connections, attach proper grounding conductor first – double-check connections.
- Keep cords dry, free of oil and grease, and protected from hot metal and sparks.
- Frequently inspect input power cord for damage or bare wiring – replace cord immediately if damaged – bare wiring can kill.
- Turn off all equipment when not in use.
- Do not use worn, damaged, undersized, or poorly spliced cables.
- Do not drape cables over your body.
- Do not touch power circuit if you are in contact with the work, ground, or another power circuit from a different machine.
- Use only well-maintained equipment. Repair or replace damaged parts at once. Maintain unit according to manual.
- Wear a safety harness if working above floor level.
- Keep all panels and covers securely in place.

SIGNIFICANT DC VOLTAGE exists in inverter-type power sources after removal of input power.

- Turn Off inverter, disconnect input power, and discharge input capacitors according to instructions in Maintenance Section before touching any internal parts.

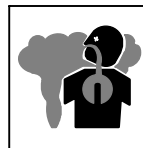

FUMES AND GASES can be hazardous.

Induction Heating of certain materials, adhesives, and fluxes can produce fumes and gases. Breathing these fumes and gases can be hazardous to your health.

- Keep your head out of the fumes. Do not breathe the fumes.
- If inside, ventilate the area and/or use local forced ventilation to remove fumes and gases.
- If ventilation is poor, wear an approved air-supplied respirator.
- Read and understand the Material Safety Data Sheets (MSDSs) and the manufacturer's instruction for adhesives, fluxes, metals, consumables, coatings, cleaners, and degreasers.
- Work in a confined space only if it is well ventilated, or while wearing an air-supplied respirator. Always have a trained watchperson nearby. Fumes and gases from heating can displace air and lower the oxygen level causing injury or death. Be sure the breathing air is safe.
- Do not heat in locations near degreasing, cleaning, or spraying operations. The heat can react with vapors to form highly toxic and irritating gases.
- Do not overheat coated metals, such as galvanized, lead, or cadmium plated steel, unless the coating is removed from the heated area, the area is well ventilated, and while wearing an air-supplied respirator. The coatings and any metals containing these elements can give off toxic fumes if overheated. See coating MSDS for temperature information.



FIRE OR EXPLOSION hazard.

- Do not overheat parts.
- Watch for fire; keep extinguisher nearby.
- Keep flammables away from work area.
- Do not locate unit on, over, or near combustible surfaces.
- Do not install unit near flammables.
- Do not operate where the atmosphere may contain flammable dust, gas, or liquid vapors (such as gasoline).
- After completion of work, inspect area to ensure it is free of sparks, glowing embers, and flames.
- Use only correct fuses or circuit breakers. Do not oversize or bypass them.



INDUCTION HEATING can cause burns.

- Hot parts and equipment can injure.
- Do not touch or handle induction head/coil during operation.
- Do not touch hot parts bare-handed.
- Allow cooling period before handling parts or equipment.
- Keep metal jewelry and other metal personal items away from head/coil during operation.

1-3. Additional Symbols for Installation, Operation, and Maintenance



FALLING UNIT can cause injury.

- Use handle and have person of adequate physical strength lift unit.
- Move unit with hand cart or similar device.
- For units without a handle, use equipment of adequate capacity to lift unit.
- When using lift forks to move unit, be sure forks are long enough to extend beyond opposite side of unit.

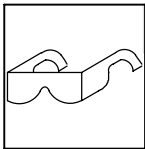

FLYING METAL OR DIRT can injure eyes.

- Wear approved safety glasses with side shields or wear face shield.



MOVING PARTS can cause injury.

- Keep away from moving parts such as fans.
- Keep all doors, panels, covers, and guards closed and securely in place.



MAGNETIC FIELDS can affect Implanted Medical Devices.

- Wearers of Pacemakers and other Implanted Medical Devices should keep away.
- Implanted Medical Device wearers should consult their doctor and the device manufacturer before going near arc welding, spot welding, gouging, plasma arc cutting, or induction heating operations.

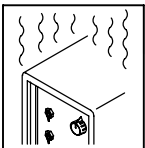

OVERUSE can cause OVERHEATING

- Allow cooling period.
- Reduce output or reduce duty cycle before starting to heat again.
- Follow rated duty cycle.

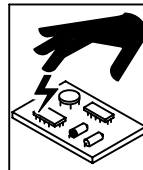

STATIC (ESD) can damage PC boards.

- Put on grounded wrist strap BEFORE handling boards or parts.
- Use proper static-proof bags and boxes to store, move, or ship PC boards.

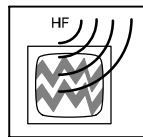

H.F. RADIATION can cause interference.

- High-frequency (H.F.) can interfere with radio navigation, safety services, computers, and communications equipment.
- Have only qualified person familiar with electronic equipment perform this installation.
- The user is responsible for having a qualified electrician promptly correct any interference problem resulting from the installation.
- If notified by the FCC about interference, stop using the equipment at once.
- Have the installation regularly checked and maintained.
- Keep high-frequency source doors and panels tightly shut.

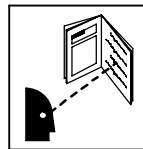

READ INSTRUCTIONS.

- Read Owner's Manual before using or servicing unit.
- Use only genuine replacement parts from the manufacturer.

1-4. California Proposition 65 Warnings

Warning: Welding or cutting equipment produces fumes or gases which contain chemicals known to the State of California to cause birth defects and, in some cases, cancer. (California Health & Safety Code Section 25249.5 et seq.)

Warning: Battery posts, terminals and related accessories contain lead and lead compounds, chemicals known to the State of California to cause cancer and birth defects or other reproductive harm. Wash hands after handling.

For Gasoline Engines:

Warning: Engine exhaust contains chemicals known to the State of California to cause cancer, birth defects, or other reproductive harm.

For Diesel Engines:

Warning: Diesel engine exhaust and some of its constituents are known to the State of California to cause cancer, birth defects, and other reproductive harm.

1-5. Principal Safety Standards

Safety in Welding, Cutting, and Allied Processes, ANSI Standard Z49.1, from Global Engineering Documents (phone: 1-877-413-5184, website: www.global.ihs.com).

OSHA, Occupational Safety and Health Standards for General Industry, Title 29, Code of Federal Regulations (CFR), Part 1910, Subpart Q, and Part 1926, Subpart J, from U.S. Government Printing Office, Superintendent of Documents, P.O. Box 371954, Pittsburgh, PA 15250-7954 (phone: 1-866-512-1800) (there are 10 Regional Offices—phone for Region 5, Chicago, is 312-353-2220, website: www.osha.gov).

National Electrical Code, NFPA Standard 70, from National Fire Protection Association, P.O. Box 9101, Quincy, MA 02269-9101 (phone: 617-770-3000, website: www.nfpa.org and www.sparky.org).

Canadian Electrical Code Part 1, CSA Standard C22.1, from Canadian Standards Association, Standards Sales, 5060 Mississauga, Ontario, Canada L4W 5NS (phone: 800-463-6727 or in Toronto 416-747-4044, website: www.csa-international.org).

Safe Practice For Occupational And Educational Eye And Face Protection, ANSI Standard Z87.1, from American National Standards Institute, 25 West 43rd Street, New York, NY 10036-8002 (phone: 212-642-4900, website: www.ansi.org).

1-6. EMF Information

Considerations About Induction Heating And The Effects Of Low Frequency Electric And Magnetic Fields

The following is a quotation from the General Conclusions Section of the U.S. Congress, Office of Technology Assessment, *Biological Effects of Power Frequency Electric & Magnetic Fields – Background Paper*, OTA-BP-E-53 (Washington, DC: U.S. Government Printing Office, May 1989): “. . . there is now a very large volume of scientific findings based on experiments at the cellular level and from studies with animals and people which clearly establish that low frequency magnetic fields can interact with, and produce changes in, biological systems. While most of this work is of very high quality, the results are complex. Current scientific understanding does not yet allow us to interpret the evidence in a single coherent framework. Even more frustrating, it does not yet allow us to draw definite conclusions about questions of possible risk or to of-

fer clear science-based advice on strategies to minimize or avoid potential risks.”

To reduce magnetic fields in the workplace, use the following procedures:

1. Arrange output cable to one side and away from the operator.
2. Do not coil or drape output cable around the body.
3. Keep power source and cable as far away from the operator as practical.

About Implanted Medical Devices:

Implanted Medical Device wearers should consult their doctor and the device manufacturer before performing or going near arc welding, spot welding, gouging, plasma arc cutting, or induction heating operations. If cleared by your doctor, then following the above procedures is recommended.

SECTION 2 – CONSIGNES DE SÉCURITÉ – LIRE AVANT UTILISATION

ihom_2007-04fre

! Se protéger, ainsi que toute autre personne travaillant sur les lieux, contre les étincelles et le métal chaud.

2-1. Signification des symboles



DANGER! – Indique une situation dangereuse qui si on l'évite pas peut donner la mort ou des blessures graves. Les dangers possibles sont montrés par les symboles joints ou sont expliqués dans le texte.



Indique une situation dangereuse qui si on l'évite pas peut donner la mort ou des blessures graves. Les dangers possibles sont montrés par les symboles joints ou sont expliqués dans le texte.

NOTE – Indique des déclarations pas en relation avec des blessures personnelles.

 Indique des instructions spécifiques.



Ce groupe de symboles veut dire Avertissement! Attention! DANGER DE CHOC ELECTRIQUE, PIECES EN MOUVEMENT, et PIECES CHAUDES. Consulter les symboles et les instructions ci-dessous y afférant pour les actions nécessaires afin d'éviter le danger.

2-2. Dangers relatifs au soudage à l'arc



Les symboles présentés ci-après sont utilisés tout au long du présent manuel pour attirer votre attention et identifier les risques de danger. Lorsque vous voyez un symbole, soyez vigilant et suivez les directives mentionnées afin d'éviter tout danger. Les consignes de sécurité présentées ci-après ne font que résumer l'information contenue dans les normes de sécurité énumérées à la section 2-5. Veuillez lire et respecter toutes ces normes de sécurité.



L'installation, l'utilisation, l'entretien et les réparations ne doivent être confiés qu'à des personnes qualifiées.



Au cours de l'utilisation, tenir toute personne à l'écart et plus particulièrement les enfants.



UNE DÉCHARGE ÉLECTRIQUE peut entraîner la mort.

Le contact de composants électriques peut provoquer des accidents mortels ou des brûlures graves. Le circuit électrique et les barres collectrices ou les connexions de sortie sont sous tension lorsque l'appareil fonctionne. Le circuit d'alimentation et les circuits internes de la machine sont également sous tension lorsque l'alimentation est sur marche. Des équipements installés ou reliés à la borne de terre de manière incorrecte sont dangereux.

- Ne pas toucher aux pièces électriques sous tension.
- Protéger toutes les barres collectrices et les raccords de refroidissement pour éviter de les toucher par inadvertance.
- Porter des gants isolants et des vêtements de protection secs et sans trous.
- S'isoler de la pièce à couper et du sol en utilisant des housses ou des tapis assez grands afin d'éviter tout contact physique avec la pièce à couper ou le sol.
- D'autres consignes de sécurité sont nécessaires dans les conditions suivantes : risques électriques dans un environnement humide ou si l'on porte des vêtements mouillés ; sur des structures métalliques telles que sols, grilles ou échafaudages ; en position coincée comme assise, à genoux ou couchée ; ou s'il y a un risque élevé de contact inévitable ou accidentel avec la pièce à souder ou le sol. Dans ces conditions, voir ANSI Z49.1 énuméré dans les normes de sécurité. En outre, ne pas travailler seul !
- Couper l'alimentation d'entrée avant d'installer l'appareil ou d'effectuer l'entretien. Verrouiller ou étiqueter la sortie d'alimentation selon la norme OSHA 29 CFR 1910.147 (se reporter aux Principales normes de sécurité).
- N'utiliser que des tuyaux de refroidissement non conducteurs ayant une longueur minimale de 457 mm pour garantir l'isolation.

- Installer le poste correctement et le mettre à la terre convenablement selon les consignes du manuel de l'opérateur et les normes nationales, provinciales et locales.
- Toujours vérifier la terre du cordon d'alimentation. Vérifier et s'assurer que le fil de terre du cordon d'alimentation est bien raccordé à la borne de terre du sectionneur ou que la fiche du cordon est raccordée à une prise correctement mise à la terre.
- En effectuant les raccordements d'entrée, fixer d'abord le conducteur de mise à la terre approprié et revérifier les connexions.
- Les câbles doivent être exempts d'humidité, d'huile et de graisse; protégez-les contre les étincelles et les pièces métalliques chaudes.
- Vérifier fréquemment le cordon d'alimentation afin de s'assurer qu'il n'est pas altéré ou à nu, le remplacer immédiatement s'il l'est. Un fil à nu peut entraîner la mort.
- L'équipement doit être hors tension lorsqu'il n'est pas utilisé.
- Ne pas utiliser des câbles usés, endommagés, de grosseur insuffisante ou mal épissés.
- Ne pas enrouler les câbles autour du corps.
- Ne pas toucher le circuit électrique si l'on est en contact avec la pièce, la terre ou le circuit électrique d'une autre machine.
- N'utiliser qu'un matériel en bon état. Réparer ou remplacer sur-le-champ les pièces endommagées. Entretien l'appareil conformément à ce manuel.
- Porter un harnais de sécurité si l'on doit travailler au-dessus du sol.
- S'assurer que tous les panneaux et couvercles sont correctement en place.

Il reste une TENSION DC NON NÉGLIGEABLE dans les sources de soudage onduleur quand on a coupé l'alimentation.

- Avant de toucher des organes internes, couper l'onduleur, débrancher l'alimentation et décharger les condensateurs d'alimentation conformément aux instructions indiquées dans la partie maintenance.

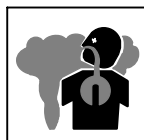

LES FUMÉES ET LES GAZ peuvent être dangereux.

Le chauffage à induction de certains matériaux, adhésifs et flux génère des fumées et des gaz. Leur inhalation peut être dangereuse pour votre santé.

- Ne pas mettre sa tête au-dessus des vapeurs. Ne pas respirer ces vapeurs.

- À l'intérieur, ventiler la zone et/ou utiliser une ventilation forcée au niveau de l'arc pour l'évacuation des fumées et des gaz.
- Si la ventilation est médiocre, porter un respirateur anti-vapeurs approuvé.
- Lire et comprendre les spécifications de sécurité des matériaux (MSDS) et les instructions du fabricant concernant les adhésifs, les flux, les métaux, les consommables, les revêtements, les nettoyeurs et les dégraissateurs.
- Travailler dans un espace fermé seulement s'il est bien ventilé ou en portant un respirateur. Demander toujours à un surveillant dûment formé de se tenir à proximité. Des fumées et des gaz provenant du chauffage peuvent déplacer l'air, abaisser le niveau d'oxygène et provoquer des lésions ou des accidents mortels. S'assurer que l'air ambiant ne présente aucun danger.
- Ne pas chauffer dans des endroits se trouvant à proximité d'opérations de dégraissage, de nettoyage ou de pulvérisation. La chaleur peut réagir en présence de vapeurs et former des gaz hautement toxiques et irritants.
- Ne pas surchauffer des métaux munis d'un revêtement tels que l'acier galvanisé, plaqué au plomb ou au cadmium, à moins que le revêtement ne soit enlevé de la zone chauffée, que la zone soit bien ventilée et, si nécessaire, en portant un respirateur. Les revêtements et tous les métaux contenant ces éléments peuvent dégager des fumées toxiques s'ils sont surchauffés. Voir les informations concernant la température dans les spécifications de revêtement MSDS.



Risque D'INCENDIE OU D'EXPLOSION.

- Ne pas surchauffer les composants .
- Attention aux risques d'incendie: tenir un extincteur à proximité.

- Stocker des produits inflammables hors de la zone de travail.
- Ne pas placer l'appareil sur, au-dessus ou à proximité de surfaces inflammables.
- Ne pas installer l'appareil à proximité de produits inflammables.
- Ne pas faire fonctionner l'appareil si l'air ambiant est chargé de particules, gaz, ou vapeurs inflammables (vapeur d'essence, par exemple).
- Une fois le travail achevé, assurez-vous qu'il ne reste aucune trace d'étincelles incandescentes ni de flammes.
- Utiliser exclusivement des fusibles ou coupe-circuits appropriés. Ne pas augmenter leur puissance; ne pas les ponter.



LE CHAUFFAGE PAR INDUCTION peut provoquer des brûlures.

- Des pièces ou de l'équipement chaud peuvent provoquer des blessures.
- Ne pas toucher ou manipuler la tête/l'enroulement à induction pendant le fonctionnement.
- Ne pas toucher des parties chaudes à mains nues.
- Laisser refroidir les composants ou équipements avant de les manipuler.
- Tenir les bijoux et autres objets personnels en métal éloignés de la tête/de l'enroulement pendant le fonctionnement.

2-3. Dangers supplémentaires en relation avec l'installation, le fonctionnement et la maintenance

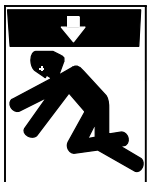

LA CHUTE DE L'APPAREIL peut blesser.

- Utiliser la poignée et demander à une personne ayant la force physique nécessaire pour soulever l'appareil.
- Déplacer l'appareil à l'aide d'un chariot ou d'un engin similaire.
- Pour les appareils sans poignée utiliser un équipement d'une capacité appropriée pour soulever l'appareil.
- En utilisant des fourches de levage pour déplacer l'unité, s'assurer que les fourches sont suffisamment longues pour dépasser du côté opposé de l'appareil.

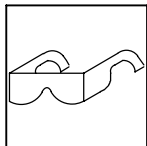

DES PIÈCES DE METAL ou DES SALETES peuvent provoquer des blessures dans les yeux.

- Porter des lunettes de sécurité à coques latérales ou un écran facial.



DES ORGANES MOBILES peuvent provoquer des blessures.

- S'abstenir de toucher des organes mobiles tels que des ventilateurs.
- Maintenir fermés et verrouillés les portes, panneaux, recouvrements et dispositifs de protection.



LES CHAMPS MAGNETIQUES peuvent affecter des implants médicaux.

- Porteur de simulateur cardiaque ou autre implants médicaux, rester à distance.
- Les porteurs d'implants doivent d'abord consulter leur médecin avant de s'approcher des opérations de soudage à l'arc, de soudage par points, de gougeage, du coupage plasma ou de chauffage par induction.

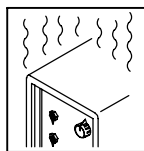

L'EMPLOI EXCESSIF peut SURCHAUFFER L'ÉQUIPEMENT.

- Prévoir une période de refroidissement
- Réduire le courant de sortie ou le facteur de marche avant de recommencer le chauffage.
- Respecter le cycle opératoire nominal.

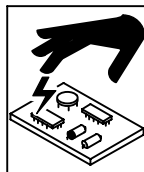

LES CHARGES ÉLECTROSTATIQUES peuvent endommager les circuits imprimés.

- Établir la connexion avec la barrette de terre AVANT de manipuler des cartes ou des pièces.
- Utiliser des pochettes et des boîtes antistatiques pour stocker, déplacer ou expédier des cartes PC.

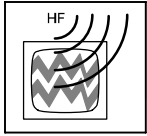

LE RAYONNEMENT HAUTE FRÉQUENCE (HF) risque de provoquer des interférences.

- Le rayonnement haute fréquence (HF) peut provoquer des interférences avec les équipements de radio-navigation et de communication, les services de sécurité et les ordinateurs.
- Demander seulement à des personnes qualifiées familiarisées avec des équipements électroniques de faire fonctionner l'installation.
- L'utilisateur est tenu de faire corriger rapidement par un électricien qualifié les interférences résultant de l'installation.

- Si le FCC signale des interférences, arrêter immédiatement l'appareil.
- Effectuer régulièrement le contrôle et l'entretien de l'installation.
- Maintenir soigneusement fermés les portes et les panneaux des sources de haute fréquence.

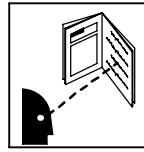

LIRE LES INSTRUCTIONS.

- Lisez le manuel d'instructions avant l'utilisation ou la maintenance de l'appareil.
- N'utiliser que les pièces de rechange recommandées par le constructeur.

2-4. Proposition californienne 65 Avertissements

⚠ Les équipements de soudage et de coupage produisent des fumées et des gaz qui contiennent des produits chimiques dont l'État de Californie reconnaît qu'ils provoquent des malformations congénitales et, dans certains cas, des cancers. (Code de santé et de sécurité de Californie, chapitre 25249.5 et suivants).

⚠ Les batteries, les bornes et autres accessoires contiennent du plomb et des composés à base de plomb, produits chimiques dont l'État de Californie reconnaît qu'ils provoquent des cancers et des malformations congénitales ou autres problèmes de procréation. Se laver les mains après manipulation.

Pour les moteurs à essence :

⚠ Les gaz d'échappement des moteurs contiennent des produits chimiques dont l'État de Californie reconnaît qu'ils provoquent des cancers et des malformations congénitales ou autres problèmes de procréation.

Pour les moteurs diesel :

⚠ Les gaz d'échappement des moteurs diesel et certains de leurs composants sont reconnus par l'État de Californie comme provoquant des cancers et des malformations congénitales ou autres problèmes de procréation.

2-5. Principales normes de sécurité

Safety in Welding, Cutting, and Allied Processes, ANSI Standard Z49.1, de Global Engineering Documents (téléphone : 1-877-413-5184, site Internet : www.global.ihf.com).

OSHA, Occupational Safety and Health Standards for General Industry, Title 29, Code of Federal Regulations (CFR), Part 1910, Subpart Q, and Part 1926, Subpart J, from U.S. Government Printing Office, Superintendent of Documents, P.O. Box 371954, Pittsburgh, PA 15250-7954 (téléphone: 1-866-512-1800) (il y a 10 bureaux régionaux--le téléphone de la région 5, Chicago, est 312-353-2220, site Internet : www.osha.gov).

National Electrical Code, NFPA Standard 70, de National Fire Protection Association, P.O. Box 9101, Quincy, MA 02269-9101 (téléphone : 617-770-3000, site Internet : www.nfpa.org et www.sparky.org).

Code électrique du Canada, partie 1, CSA Standard C22.1, from Canadian Standards Association, Standards Sales, 5060 Mississauga, Ontario, Canada L4W 5N5 (téléphone : 800-463-6727 ou en Toronto 416-747-4044, site internet : www.csa-international.org).

Safe Practice For Occupational And Educational Eye And Face Protection, ANSI Standard Z87.1, de American National Standards Institute, 25 West 43rd Street, New York, NY 10036-8002 (téléphone : 212-642-4900, site Internet : www.ansi.org).

2-6. Information EMF

Considérations relatives au chauffage à induction et aux effets des champs électriques et magnétiques basse fréquence.

Le texte suivant est extrait des conclusions générales Département du Congrès U.S., Office of Technology Assessment, Effets biologiques des champs *magnétiques et électriques basse fréquence – Background Paper*, OTA-BP-E-53 (Washington, DC: U.S. Government Printing Office, May 1989): "... on dispose maintenant d'importantes découvertes scientifiques reposant sur des expériences effectuées dans le domaine cellulaire et des études réalisées sur des animaux et des personnes qui démontrent clairement que des champs magnétiques basse fréquence peuvent avoir une interaction et produire des changements dans les systèmes biologiques. Alors que la plus grande partie de cet ouvrage est d'une très grande qualité, les résultats sont complexes. La compréhension scientifique courante ne nous permet pas encore d'interpréter la preuve fournie dans un seul ouvrage cohérent. Il est encore plus frustrant de ne pas pouvoir tirer des conclusions définitives en ce qui concerne les problèmes de risque possible ou de proposer des recommandations scientifiques

claires pour des stratégies à suivre en vue de minimiser ou de prévenir des risques potentiels."

Pour réduire les champs magnétiques sur le poste de travail, appliquer les procédures suivantes :

4. Disposer le câble de sortie d'un côté à distance de l'opérateur
5. Ne pas enrouler ou draper le câble électrique autour du corps.
6. Placer la source de courant et le câble le plus loin possible de l'opérateur.

En ce qui concerne les implants médicaux :

Les porteurs d'implants doivent d'abord consulter leur médecin avant de s'approcher des opérations de soudage à l'arc, de soudage par points, de gougeage, du coupage plasma ou de chauffage par induction. Si le médecin approuve, il est recommandé de suivre les procédures précédentes.

SECTION 3 – DEFINITIONS

3-1. Warning Label Definitions



Warning! Watch Out! There are possible hazards as shown by the symbols.

- 1 Electric shock from wiring can kill.
 - 1.1 Wear dry insulating gloves. Do not wear wet or damaged gloves.
 - 1.2 Disconnect input plug or power before working on machine.
- 2 Induction heating can cause injury or burns from hot items such as rings, watches, or parts.
 - 2.1 Do not wear metal jewelry and other metal personal items such as rings and watches during operation.
 - 2.2 Do not touch hot parts or hot head/coil.
- 3 Induction heating sparks can cause fire. Do not overheat parts and adhesives.
 - 3.1 Keep flammables away from heating operation. Do not heat near flammables.
 - 3.2 Heating sparks can cause fires. Have a fire extinguisher nearby and have a watchperson ready to use it.
- 4 Breathing heating fumes can be hazardous to your health. Read Material Safety Data Sheets (MSDSs) and manufacturer's instructions for material used.
 - 4.1 Keep your head out of the fumes.
 - 4.2 Use forced ventilation or local exhaust to remove the fumes.
 - 4.3 Use ventilating fan to remove fumes.
- 5 Always wear safety glasses or goggles during and around heating operations to prevent possible injury.
 - 5.1 Wear either safety glasses or full goggles depending on type of operation and nearby processes.
- 6 Do not remove or paint over (cover) the label.
- 7 Become trained and read the instructions before working on the machine or heating.

3-2. Warning Label Definitions (Continued)

- 1 Warning! Watch Out! There are possible hazards as shown by the symbols.
- 2 Electric shock from wiring can kill.
- 3 Overuse can cause overheating. Follow rated duty cycle.
- 4 Disconnect input plug or power before working on machine.
- 5 Become trained and read the instructions before working on the machine.
- 6 Connect green or green/yellow grounding conductor to ground terminal.
- 7 Connect input conductors (L1, L2 And L3) to line terminals.







194 466

- 1 Warning! Watch Out! There are possible hazards as shown by the symbols.
- 2 Electric shock from wiring can kill.
- 3 Disconnect input plug or power before working on machine.
- 4 Do not touch input capacitor(s). Allow time for capacitor(s) to discharge. Check input capacitor(s) voltage (see Section 9-7).

227 085-A

3-3. Rating Label For CE Products

☞ For label location see Section 4-2.

			CE	
MILLER ELECTRIC MFG. CO., APPLETON, WI USA				
ProHeat 35 907298		S/N -SERIAL-		
				
		.2kW	to	35kW
	5kHz-30kHz	X		100%
	U0 = N/A	I2		700 A
		U2		700 V
	U1 400-460	I1 max 50A		
3~ 50/60 Hz			P1 max 37kW	
IP23CM				
2x1 ~ 50/60 Hz		115V	2.5A	

EVIDENCE OF LABEL TAMPERING VOIDS WARRANTY 226534-B

226 534-B

3-4. WEEE Label (For Products Sold Within The EU)

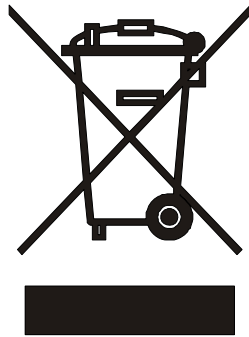











Do not discard product (where applicable) with general waste.

Reuse or recycle Waste Electrical and Electronic Equipment (WEEE) by disposing at a designated collection facility.

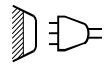
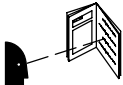
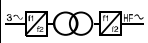
Contact your local recycling office or your local distributor for further information.

3-5. Symbols And Definitions

 Some symbols are found only on CE products.

A Amperes	V Volts	 Alternating Current	X Duty Cycle
IP Degree Of Protection	Hz Hertz	 Circuit Protection	 Output
 Increase	 Line Connection	I₁ Primary Current	I₂ Rated Current
U₁ Primary Voltage	U₂ Load Voltage	 Read Instructions	 Three Phase Static Frequency Converter-Transformer-Frequency Converter
I_{1max} Rated Maximum Supply Current	P_{1max} Maximum Power Consumption	 Three Phase	% Percent
 Remote	 Panel/Local	 High Temperature	 Voltage Input
 Off	I On		

SECTION 4 – INSTALLATION

4-1. Specifications

Output Frequency	Rated Output		Required Reflective Inductance	Amperes Input at Rated Load Output 50 or 60 Hz, Three-Phase			kVA	kW	Overall Dimensions	Weight
	Single Output	Dual Output		400 V	460 V	575 V				
5 To 30 kHz	35 kW At 100% Duty Cycle 350 A (RMS), 700 V (RMS)	35 kW At 100% Duty Cycle 700 A (RMS), 700 V (RMS)	2.5 To 50 μ h	60 A	50 A	40 A	39	37	Length: 36-3/4 in (993 mm) Width: 21-1/2 in (546 mm) Height: 29 in (737 mm)	227 lb (103 kg)
Storage Temperature Range -40° F (-40° C) to 122° F (50° C)										
*While idling										

4-2. Selecting A Location



Movement

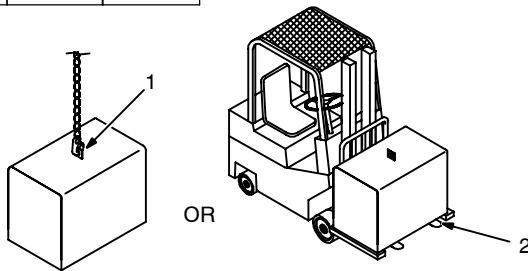

- 1 Lifting Eye
- 2 Lifting Forks

Use lifting eye or lifting forks to move unit.

If using lifting forks, extend forks beyond opposite side of unit.

- 3 Rating Label (Non CE Models Only)

Use rating label to determine input power needs. Label located under front access door.

- 4 Plate Label (CE Models Only)

Label located under power switch.

- 5 Rating Label (CE Models Only)

Use rating label to determine input power needs.

- 6 Line Disconnect Device

Locate unit near correct input power supply.

⚠ Special installation may be required where gasoline or volatile liquids are present – see NEC Article 511 or CEC Section 20.

Location And Airflow

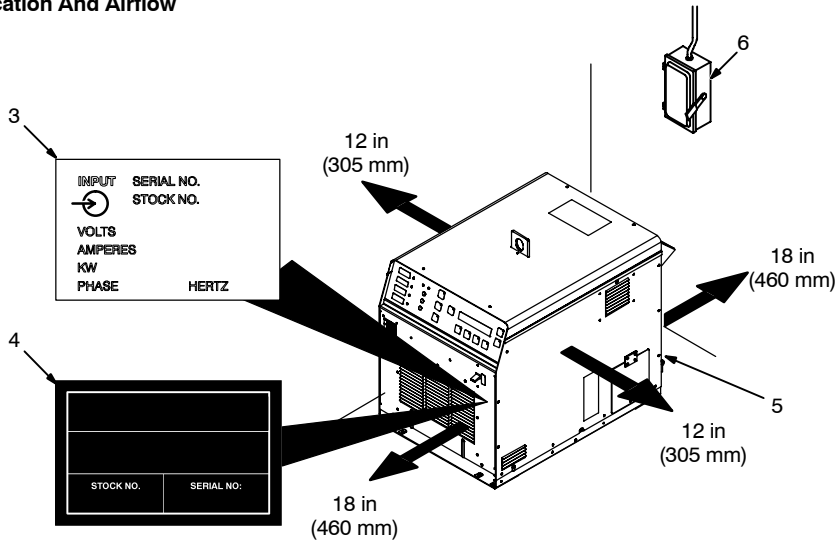

803 992-B

4-3. Tipping



⚠ Do not move or operate unit where it could tip.

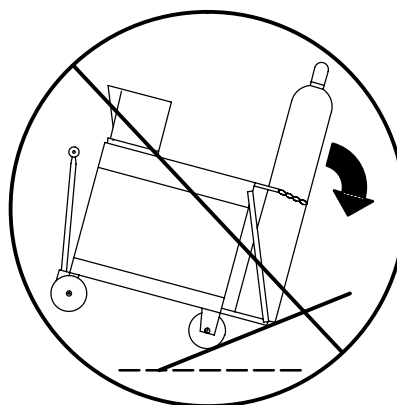
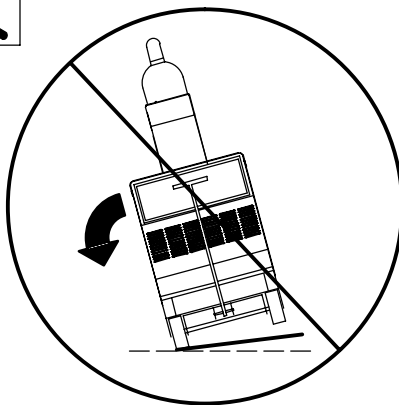

4-5. Connecting 3-Phase Input Power For 460/575 Volt Models

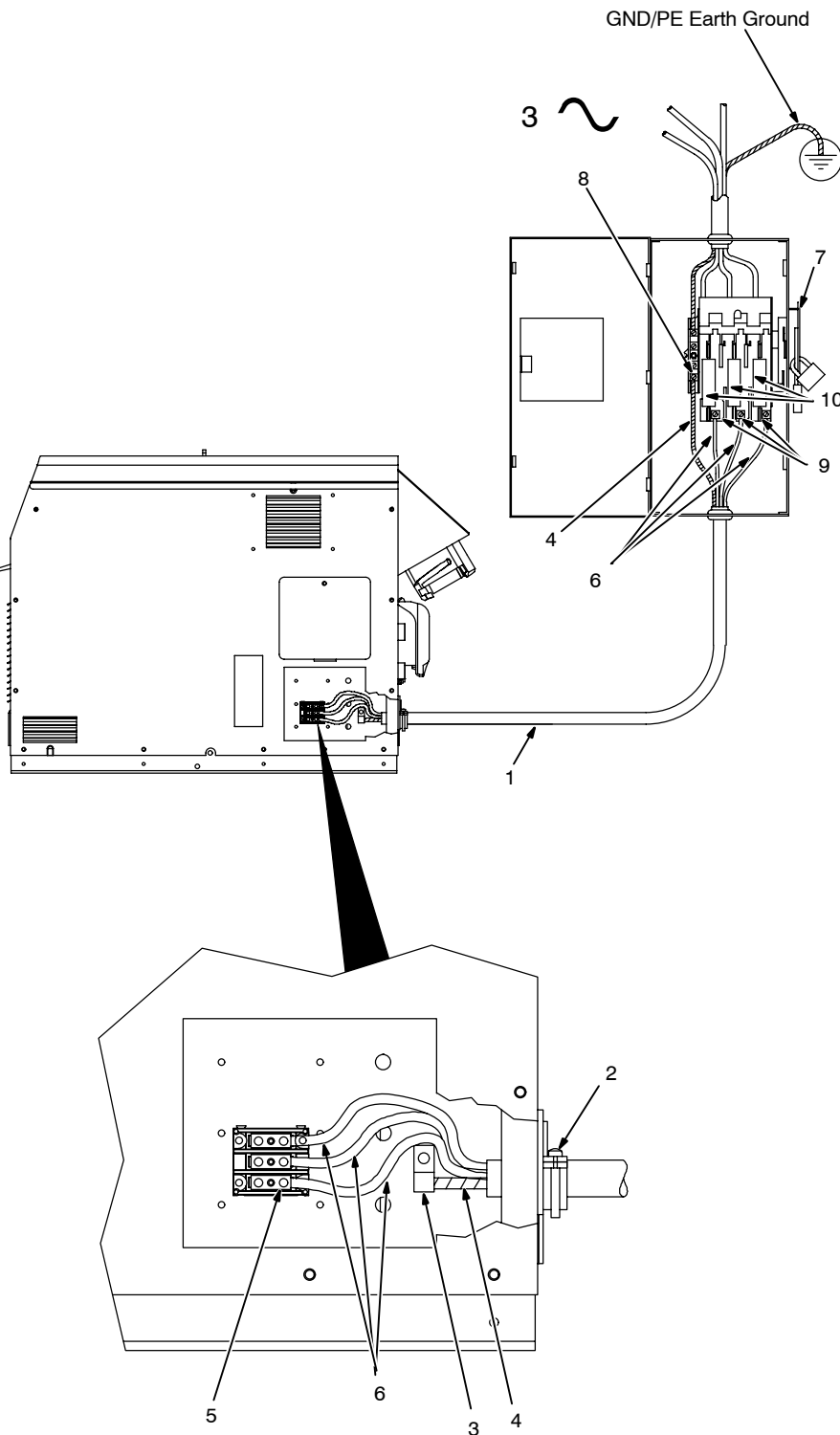

⚠ Installation must meet all National and Local Codes – have only qualified persons make this installation.

⚠ Disconnect and lockout/tagout input power before connecting input conductors from unit.

⚠ Make input power connections to the welding power source first.

⚠ Always connect green or green/yellow conductor to supply grounding terminal first, and never to a line terminal.

ℹ The circuitry in this unit automatically adapts the power source to the primary voltage being applied. Check input voltage available at site. This unit can be connected to either 460 or 575 VAC input power.

See rating label on unit and check input voltage available at site.

1 Input Power Conductors (Customer Supplied Cord)

Select size and length of conductors using Section 4-4. Conductors must comply with national, state, and local electrical codes. If applicable, use lugs of proper amperage capacity and correct hole size.

Welding Power Source Input Power Connections

2 Strain Relief

Route conductors (cord) through strain relief and tighten screws.

3 Machine Grounding Terminal

4 Green Or Green/Yellow Grounding Conductor

Connect green or green/yellow grounding conductor to welding power source grounding terminal first.

5 Welding Power Source Line Terminals

6 Input Conductors L1 (U), L2 (V) And L3 (W)

Connect input conductors L1 (U), L2 (V) and L3 (W) to welding power source line terminals.

Close and secure access door on welding power source.

Disconnect Device Input Power Connections

7 Disconnect Device (switch shown in OFF position)

8 Disconnect Device (Supply) Grounding Terminal

Connect green or green/yellow grounding conductor to disconnect device grounding terminal first.

9 Disconnect Device Line Terminals

Connect input conductors L1 (U), L2 (V) And L3 (W) to disconnect device line terminals.

10 Over-Current Protection

Select type and size of over-current protection using Section 4-4 (fused disconnect switch shown).

Close and secure door on line disconnect device. Remove lockout/tagout device, and place switch in the On position.

Tools Needed:

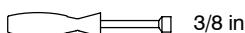

803 994-C

4-6. Connecting 3-Phase Input Power For 400/460 Volt Models

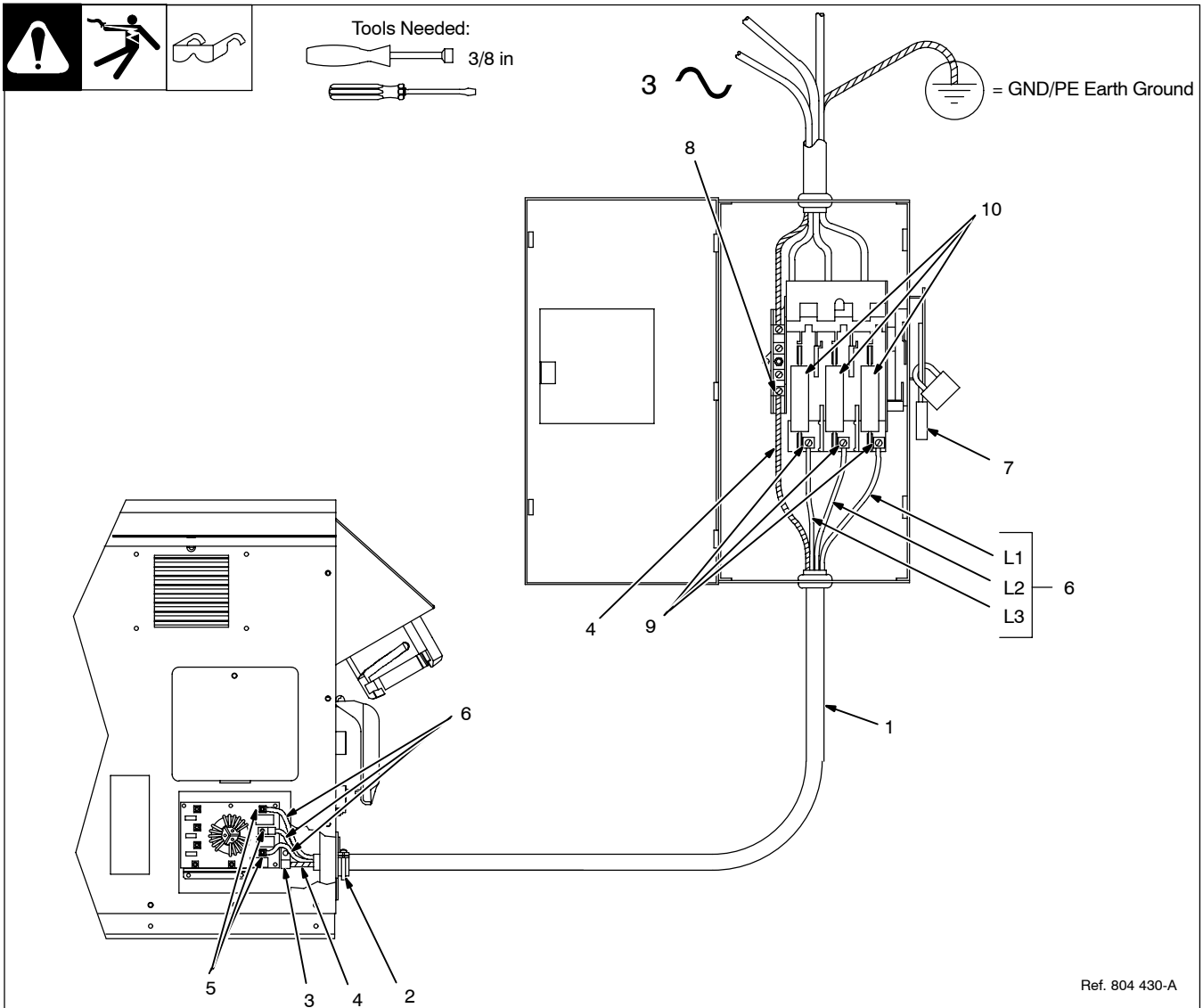

⚠ Installation must meet all National and Local Codes – have only qualified persons make this installation.

⚠ Disconnect and lockout/tagout input power before connecting input conductors from unit.

⚠ Make input power connections to the welding power source first.

⚠ Always connect green or green/yellow conductor to supply grounding terminal first, and never to a line terminal.

☞ The circuitry in this unit automatically adapts the power source to the primary voltage being applied. Check input voltage available at site. This unit can be connected to either 400 or 460 VAC input power.

See rating label on unit and check input voltage available at site.

1 Input Power Conductors (Customer Supplied Cord)

Select size and length of conductors using Section 4-4. Conductors must comply with national, state, and local electrical codes. If applicable, use lugs of proper amperage capacity and correct hole size.

Welding Power Source Input Power Connections

2 Strain Relief

Route conductors (cord) through strain relief and tighten screws.

3 Machine Grounding Terminal

4 Green Or Green/Yellow Grounding Conductor

Connect green or green/yellow grounding conductor to welding power source grounding terminal first.

5 Welding Power Source Line Terminals

6 Input Conductors L1 (U), L2 (V) And L3 (W)

Connect input conductors L1 (U), L2 (V) and L3 (W) to welding power source line terminals.

Close and secure access door on welding power source.

Disconnect Device Input Power Connections

7 Disconnect Device (switch shown in OFF position)

8 Disconnect Device (Supply) Grounding Terminal

Connect green or green/yellow grounding conductor to disconnect device grounding terminal first.

9 Disconnect Device Line Terminals

Connect input conductors L1 (U), L2 (V) And L3 (W) to disconnect device line terminals.

10 Over-Current Protection

Select type and size of over-current protection using Section 4-4 (fused disconnect switch shown).

Close and secure door on line disconnect device. Remove lockout/tagout device, and place switch in the On position.

4-7. Power Source Output Connections

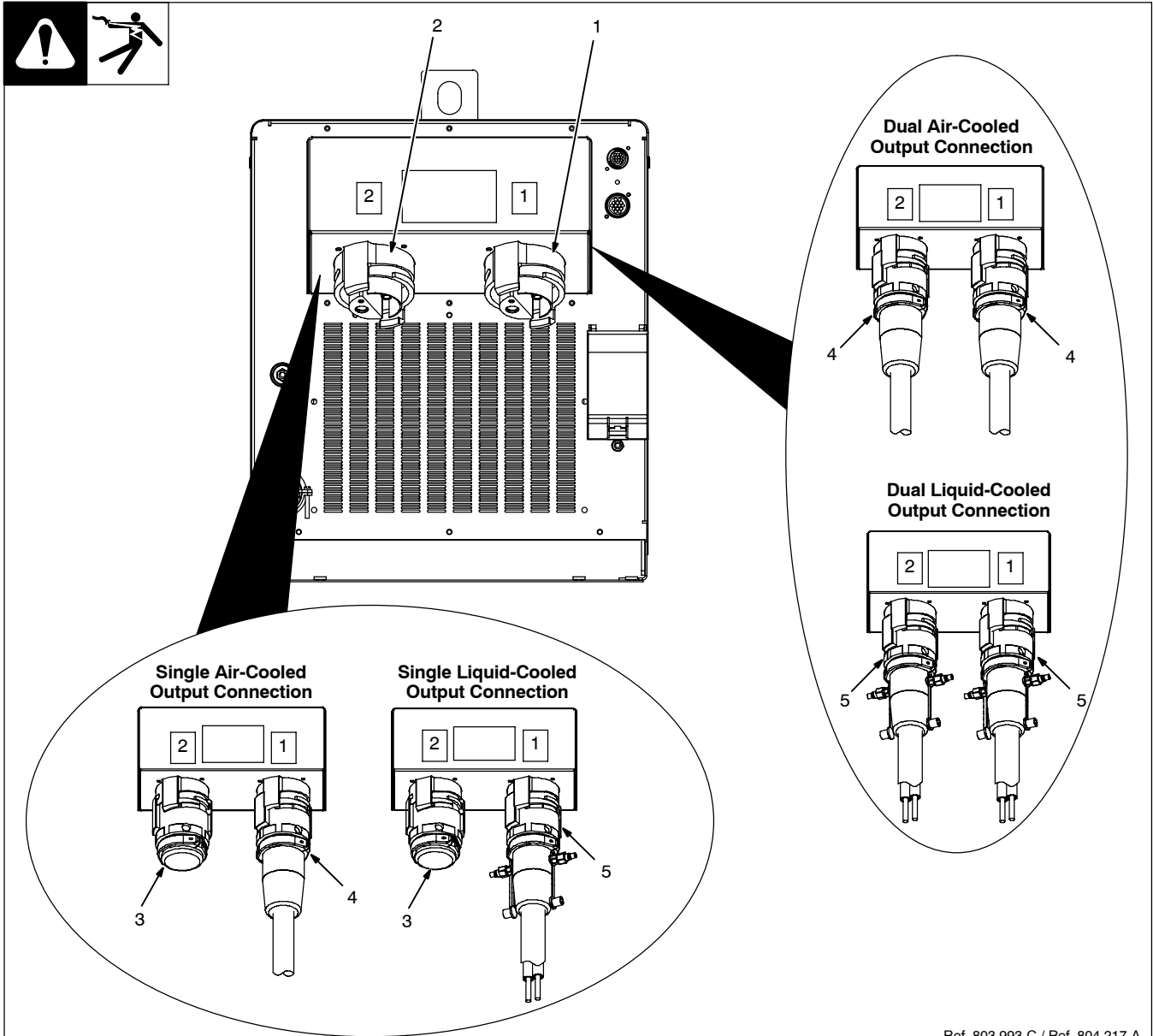

Ref. 803 993-C / Ref. 804 217-A

- 1 Output Connector 1
- 2 Output Connector 2
- 3 Protective Plug
- 4 Air-Cooled Extension Cable
- 5 Liquid-Cooled Extension Cable

The power source is capable of single or dual output. When connected for single power output, up to 35 kW is available at the single output connection. When connected for dual power, output power is divided between the two output

connections.

Single Air-Cooled Output Connection

Connect air-cooled output extension cable to Output Connector 1 or Output Connector 2. Connect Protective Plug to remaining Output Connector.

Single Liquid-Cooled Output Connection

Connect liquid-cooled output extension cable to Output Connector 1 or Output Connector 2. Connect Protective Plug to remaining Output Connector.

Dual Air-Cooled Output Connection

Connect air-cooled output extension cables to Output Connector 1 and Output Connector 2.

Dual Liquid-Cooled Output Connection

Connect liquid-cooled output extension cables to Output Connector 1 and Output Connector 2.

⚠ Extension cables must be the same length: 25 ft (7.6 m) or 50 ft (15.2 m).

4-8. Remote 14 Receptacle RC14 Information and Connections

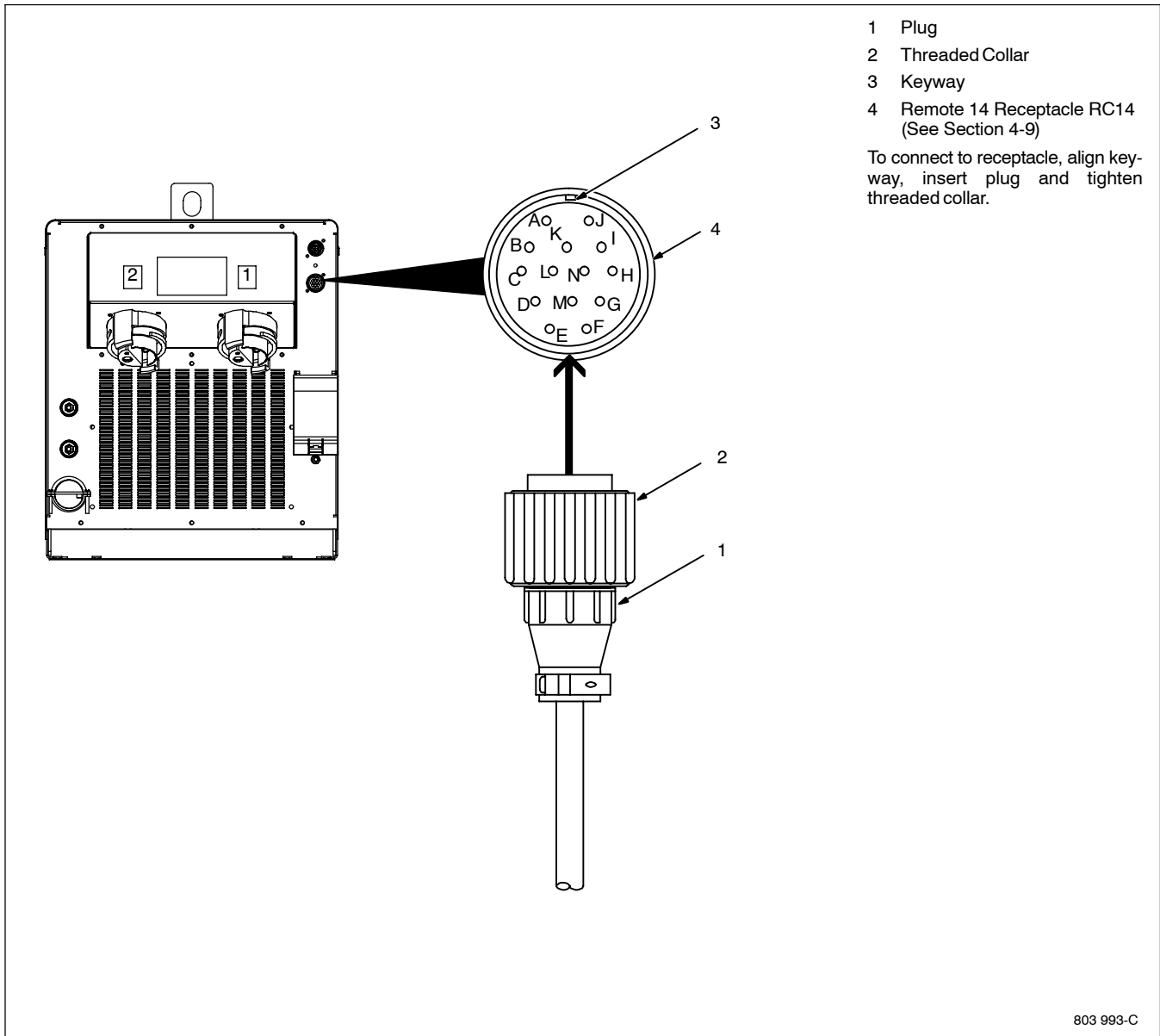

803 993-C

4-9. Remote 14 Socket Information

Socket	 REMOTE 14	Socket Information
A B	Remote Contactor	+24 volts dc. Contact closure to A completes 24 volts dc contactor control circuit.
C D E G	Remote Output Control	Command reference; +10 volts dc. Control circuit common. Input command signal (potentiometer wiper or 0 to +10 volts dc). Not used.
F, J	Power Source Limit	Absence of internal contact closure between F and J signals power source error to remote control device.
H I L M N K	Remote Metering	Not used. Actual frequency output signal (1 volt/10 kHz). Average power output signal (1 volt/10 kW). Voltage output signal RMS (1 volt/100 volts). Total current output signal RMS (1 volt/100 amperes). Chassis common.

4-10. Temperature Recorder Receptacle RC9 Information And Connections

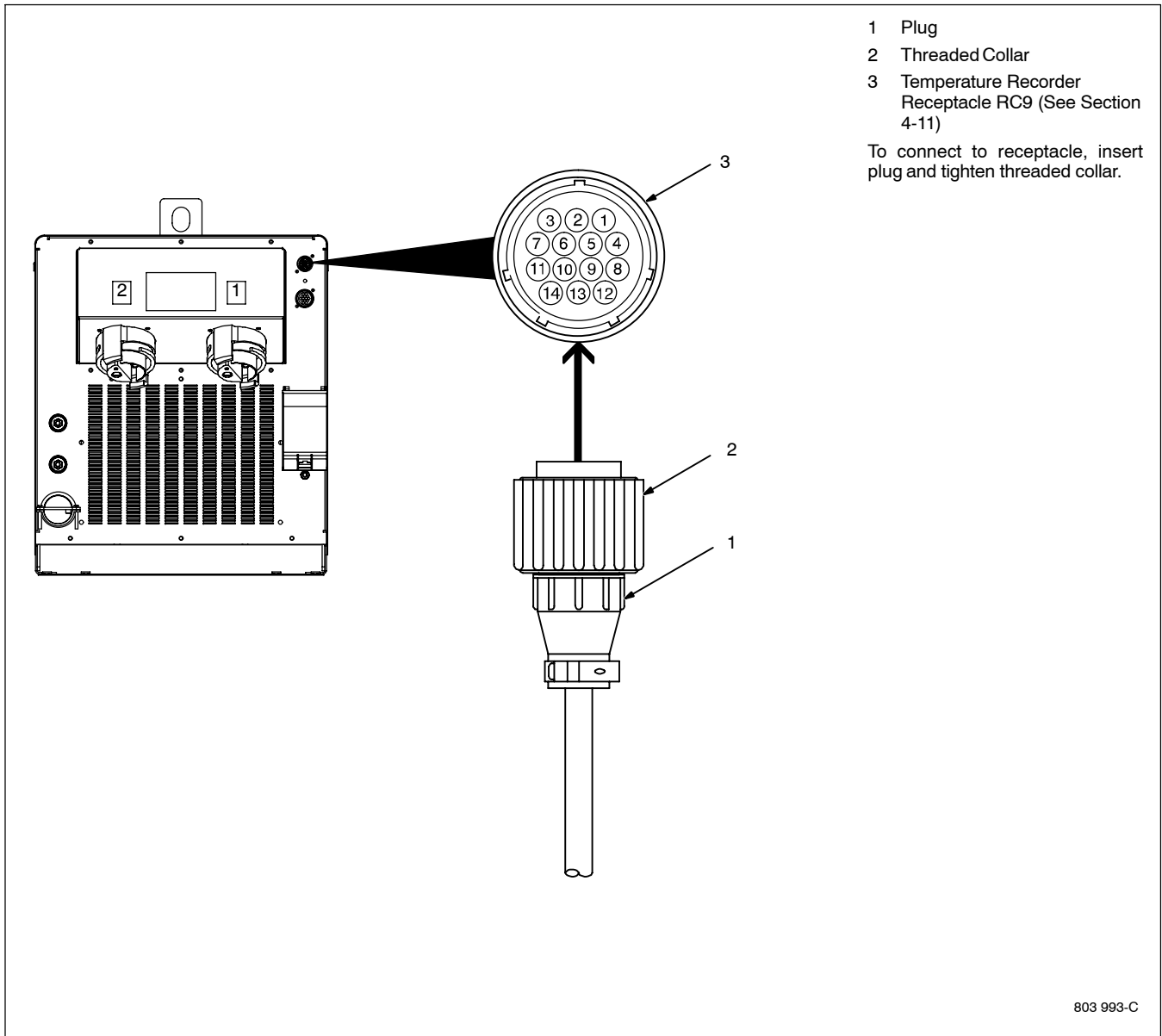

4-11. Temperature Recorder Socket Information

Socket No.	Socket Information	
	Socket No.	Socket Information
1	1	Thermocouple No. 1 (TC1), 0-10 volt dc signal [0V = -50° F (-46° C), 10V = 1500° F (816° C)]
2	2	Thermocouple No. 2 (TC2), 0-10 volt dc signal [0V = -50° F (-46° C), 10V = 1500° F (816° C)]
3	3	Thermocouple No. 3 (TC3), 0-10 volt dc signal [0V = -50° F (-46° C), 10V = 1500° F (816° C)]
4	4	Thermocouple No. 4 (TC4), 0-10 volt dc signal [0V = -50° F (-46° C), 10V = 1500° F (816° C)]
5	5	Signal Common
6	6	Thermocouple No. 5 (TC5), 0-10 volt dc signal [0V = -50° F (-46° C), 10V = 1500° F (816° C)]
7	7	Thermocouple No. 6 (TC6), 0-10 volt dc signal [0V = -50° F (-46° C), 10V = 1500° F (816° C)]
8	8	Unused
9	9	Unused
10	10	Chassis Ground
11	11	Unused
12	12	Unused
13	13	Unused
14	14	Unused

4-12. Secondary Insulation Protection

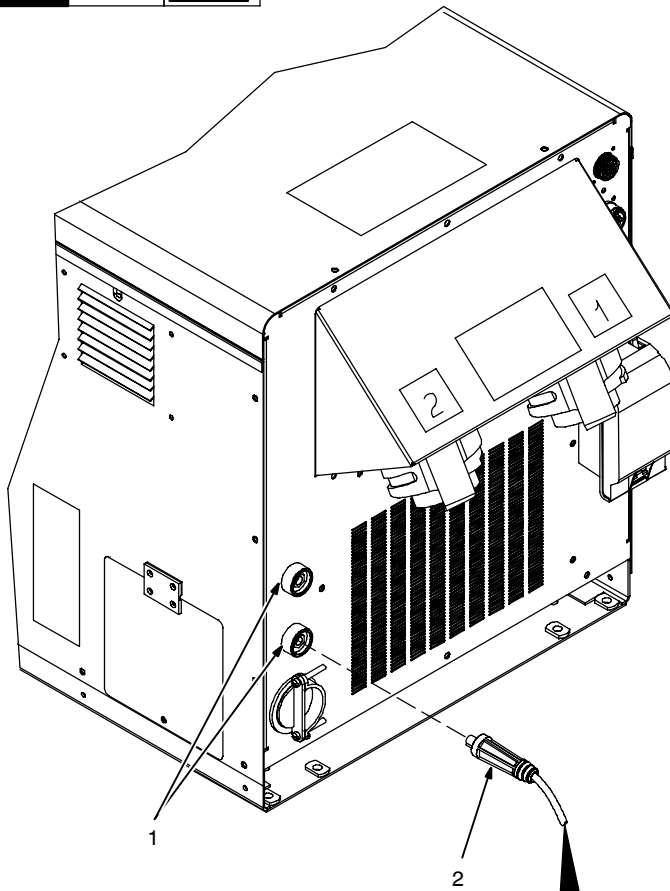

Secondary insulation protection circuitry automatically shuts down the power source output if a potentially hazardous condition exists at the heating device connected to the power source (e.g. insulation has broken down on a heating blanket causing the conductor to come into contact with the workpiece or a heating coil touches the workpiece causing a short in the output circuit).

The supplied ground lead(s) must be connected between the workpiece and power source to provide proper secondary insulation protection from a short in the output circuit.

For single output, only one ground lead is required. For dual output, use both ground leads.

- 1 Receptacles
- 2 Plug

To connect plug, align key with key-way, insert end into receptacle, and rotate plug until tight.

- 3 Handle
- 4 Magnet

 *The secondary isolation magnet must be in contact with bare metal (free from rust, paint, grease, etc.).*

- 5 Workpiece

Use handle to place magnet on the workpiece.

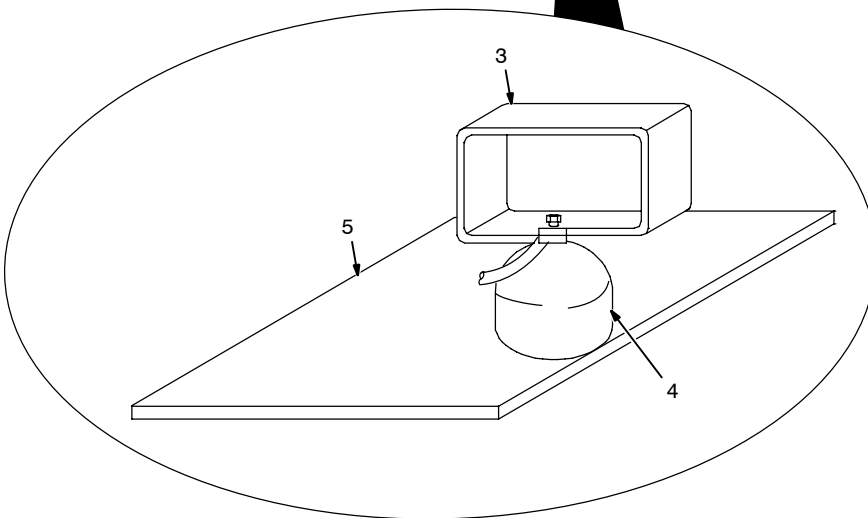

4-13. 115 Volt AC Duplex Receptacle And Supplementary Protector

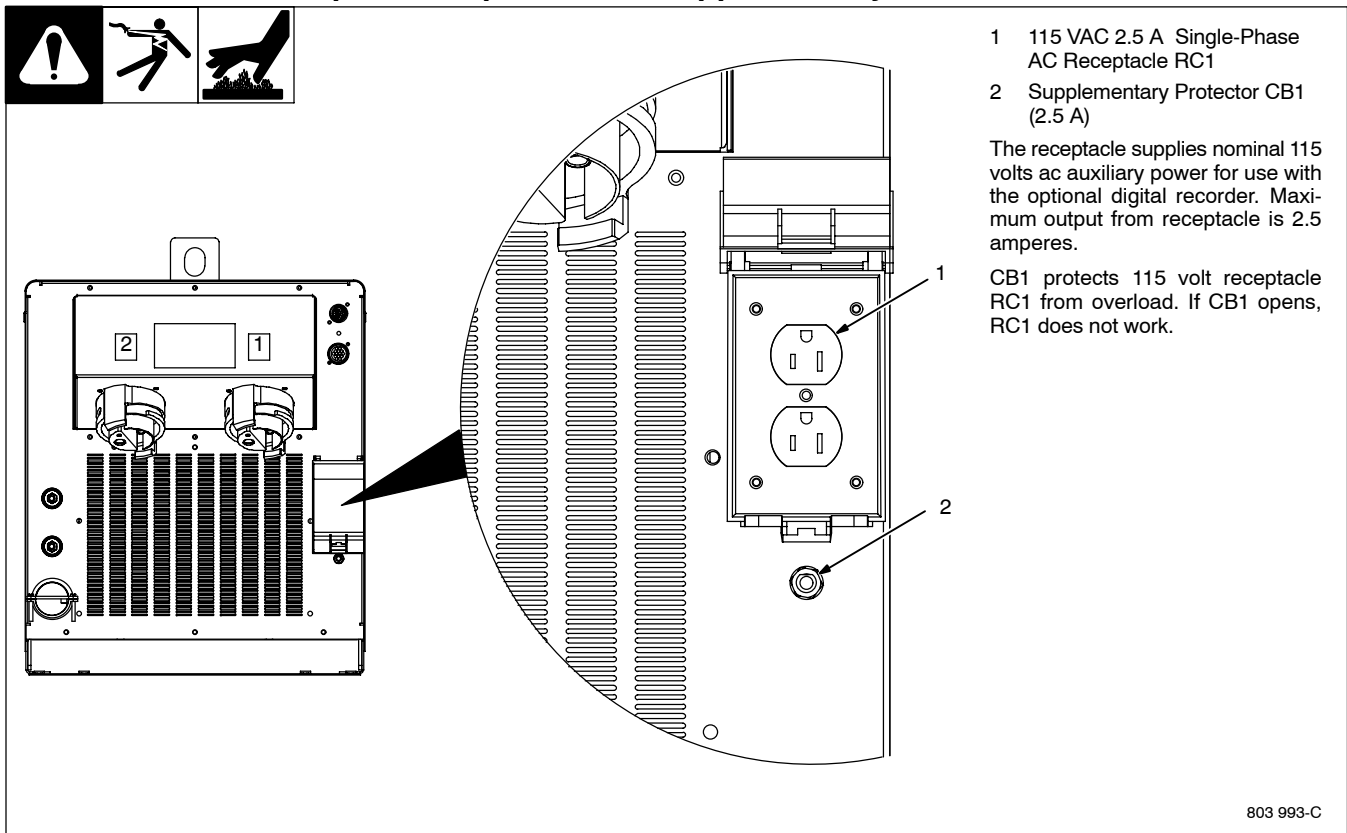

4-14. Locating Thermocouples



Thermocouple location is one of the most critical steps in the Heat Treatment Operation.

Thermocouples shall be located as follows to provide a survey of heating uniformly and enable time and temperature control:

1. Locate thermocouples to ensure that the full area of the heat band is monitored.
 - The code normally specifies the number of thermocouples to be used based on the pipe diameter.
 - The control thermocouple is placed in the plane of the weld (center of the heat zone).
 - The control thermocouple is placed at the top of the pipe in a standard pipe joint configuration. In other applications, the thermocouple should be located in the hottest portion of the weldment to be stress relieved.
2. Consider all nozzles and other welded attachments that cause potential heat sinks through metal mass or cold spots due to heat convection or conduction, and have additional thermocouples applied.
3. Attach a spare thermocouple beside control thermocouples.
4. Attach thermocouples to ensure uniformity of temperature in both thin and thick workpieces.
5. Physically inspect all thermocouples for continuity and mark them by an identification number corresponding to the recorder channel.
6. Match the drawings of the workpiece indicating the numerous thermocouple locations, controlling thermocouple locations, etc. to weld identification information.
7. The system is equipped with 3-pin thermocouple connections at the front of the unit. Six thermocouples can be attached to the power source.
 - The system is equipped with 3-pin connectors to accommodate shielded extension cables. The shielded cables protect from electrical interference.
8. Type K thermocouple wire has a positive and negative wire. The positive wire is marked as solid yellow or striped yellow. The connector screw terminals are marked positive and negative. Be sure to attach the wire to the connector with proper polarity.

9. The following describes the thermocouple routing from work to power source.
- Type K thermocouple wire (two wire) is attached directly to the workpiece using a Thermocouple Attachment Unit (see next section for information on attaching thermocouples).
 - The other end is fitted with a 2-pin type K connector.
 - The 2-pin connector plugs into the 3-pin composite extension cable. The extension cable has a six-channel block of 3-pin female connectors. The pin size locates the position of the 2-pin connector on the extension.
 - The extension cable contains six, 3-wire bundles of shielded cable.
 - The 3-pin male extension cable plugs into the 3-pin female connector on the front of the power source.

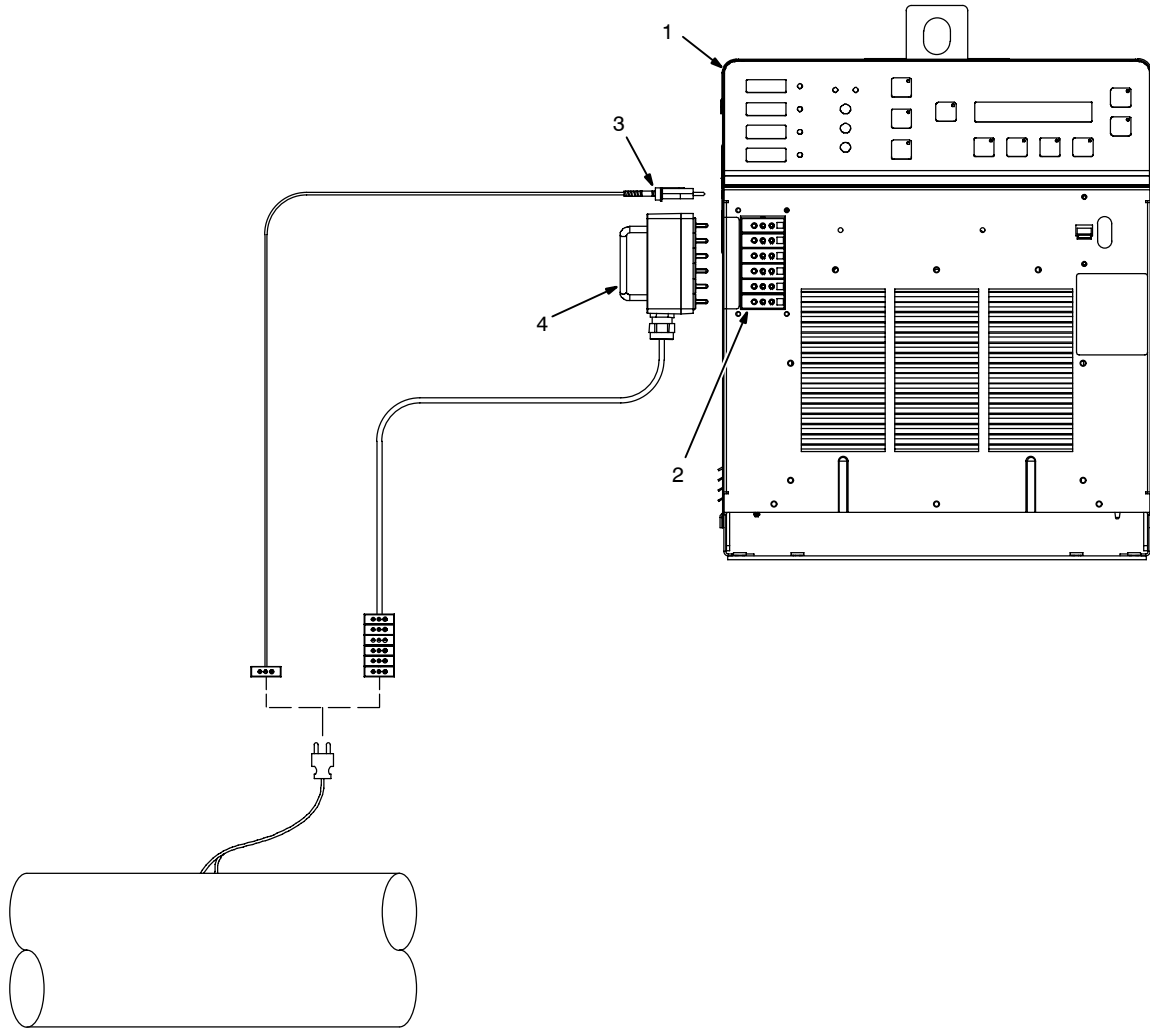

For temperature control mode, the power source must have (as a minimum) one thermocouple connected to receptacle TC1. If multiple thermocouples are desired, either use individual thermocouple plugs or the thermocouple extension cable.

To connect thermocouples to the power source, proceed as follows:

⚠ Do NOT weld thermocouples to work-piece while thermocouple cable is connected to the power source.

Turn Off power source.

- 1 Power Source
- 2 Thermocouple Receptacles

3 Individual Thermocouple Extension Cable

4 Multiple Thermocouple Extension Cable

Align plug pin(s) with receptacle socket(s) and push plug into receptacle.

804 320-A

4-15. Attaching Welded Thermocouples

 Do NOT weld thermocouples while connected to power source.

1. Attach thermocouples using a portable Thermocouple Attachment Unit (TAU). This unit spot welds thermocouple wire directly to the workpiece. This method of thermocouple attachment ensures accurate temperature measurement.
2. Clean (file or grind) any loose scale or rust from the workpiece at the places where the wires will be attached.
3. Clean the location for the lead magnet to minimize resistance. Place the magnet as near to the thermocouple positions as possible.
4. Strip 1/4 inch of insulation from the thermocouple wires.
5. Set the output variable control of the TAU to about eighty percent (80%).
6. Grasp one of the stripped wires with the tip of the jaws of the application pliers.

 Don't touch both wires of the thermocouple to the pliers at the same time when energizing the Thermocouple Attachment Unit. This will cause the thermocouple wire to fuse to the pliers, rather than the workpiece.

7. Press the end of the wire to the workpiece at ninety degrees to the surface, and maintain a firm pressure. Make sure the Thermocouple Attachment Unit is charged and wait for the ready light to glow.
8. Press discharge button, and the wire should weld to the workpiece. There will be a sharp crack and a slight arc flash.
9. Repeat the process with the other wire, placing it approximately 1/4 inch away from the first wire. Attach a spare thermocouple, and support both thermocouples approximately 18 inches back from the connection with a band or fiber tape.
10. Carefully bend the wire over at right angles. This brings the thermocouple wires out along or parallel to the workpiece. It also tests the strength of the weld. If the weld shows signs of breaking, remove the wire, restrip the end, and repeat the process.

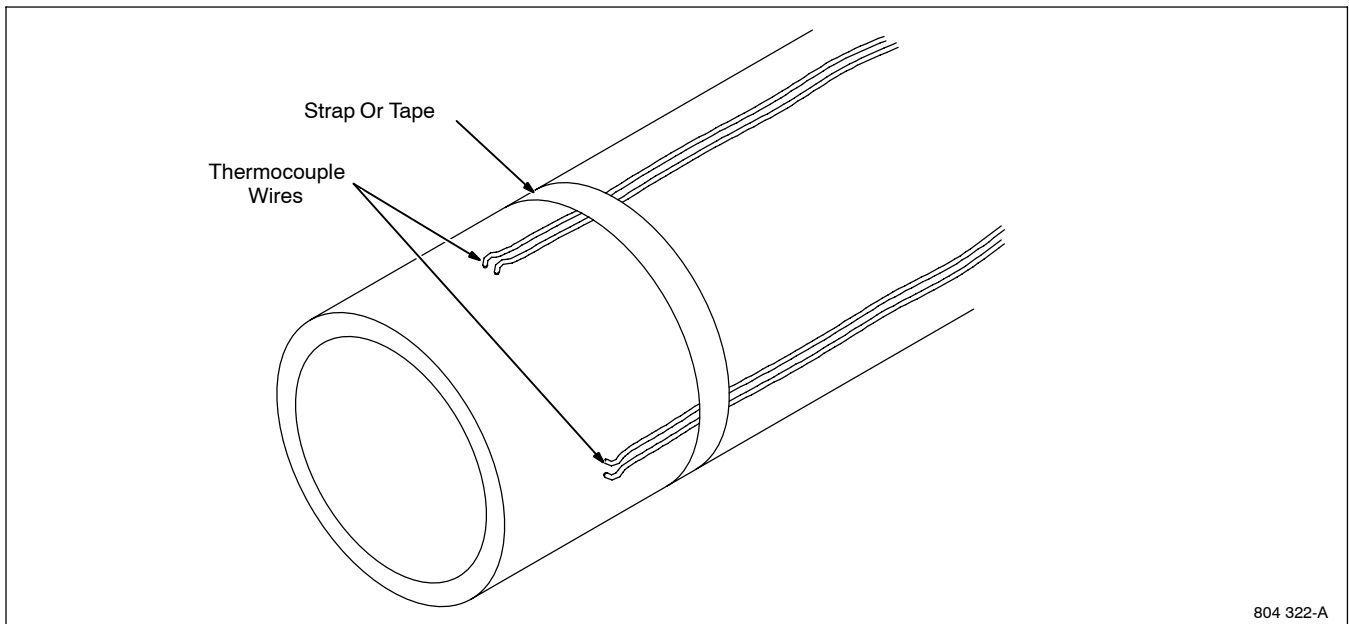

804 322-A

4-16. Using Contact Thermocouples

The welded thermocouples discussed previously can be used for preheating or stress relieving. As an alternative, in preheating applications, a contact temperature sensor* can be used. This eliminates the need to weld thermocouples and the sensor can be moved during the preheat process to check temperatures at other locations on the joint.

 Removing the contact probe will display a short duration of heat drop on the temperature recorder, if used.

The contact temperature sensor can be plugged into the thermocouple extension cable or a Type K 25 ft. armored extension cable* can be used. One of these extensions is required for each sensor.

In preheating applications, the thermocouple must be placed under the induction coil. Temperatures at the weld joint can be checked with temperature sensitive crayons to verify the preheat temperature.

Welded thermocouples are normally used in stress relieving applications due to their accuracy.

*See product literature for item part number.

4-17. Placing Temperature Probe

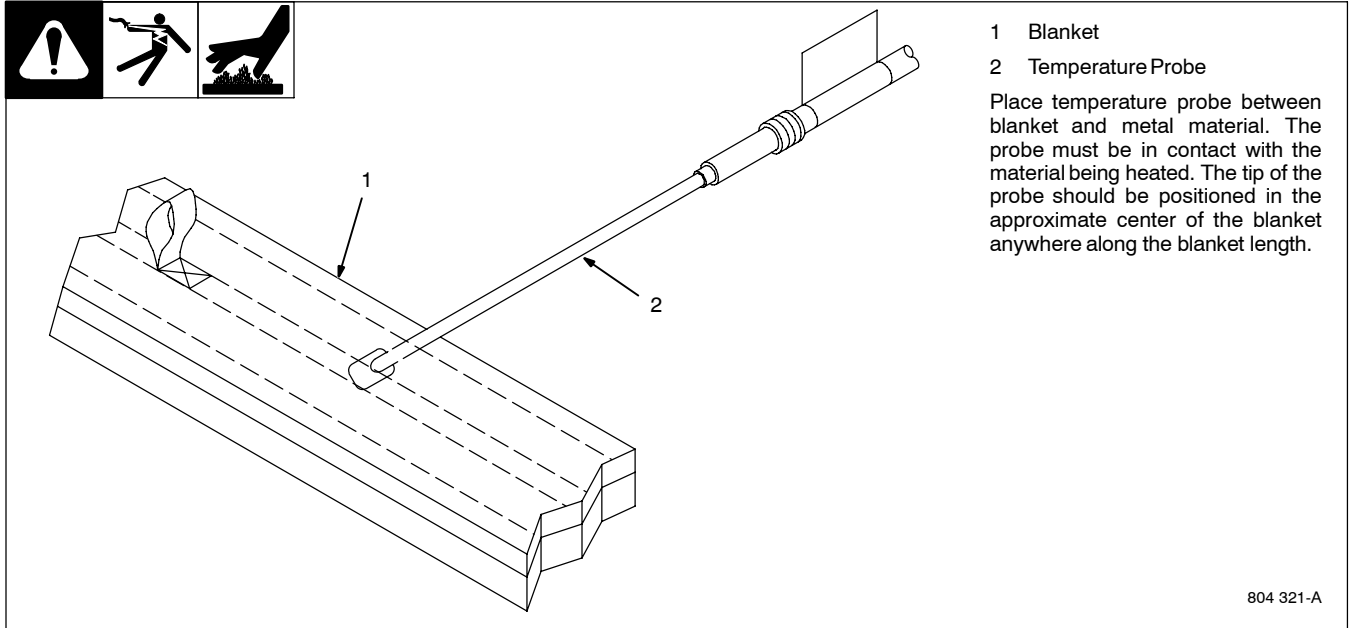

SECTION 5 – COMPONENTS AND CONTROLS

5-1. Controls

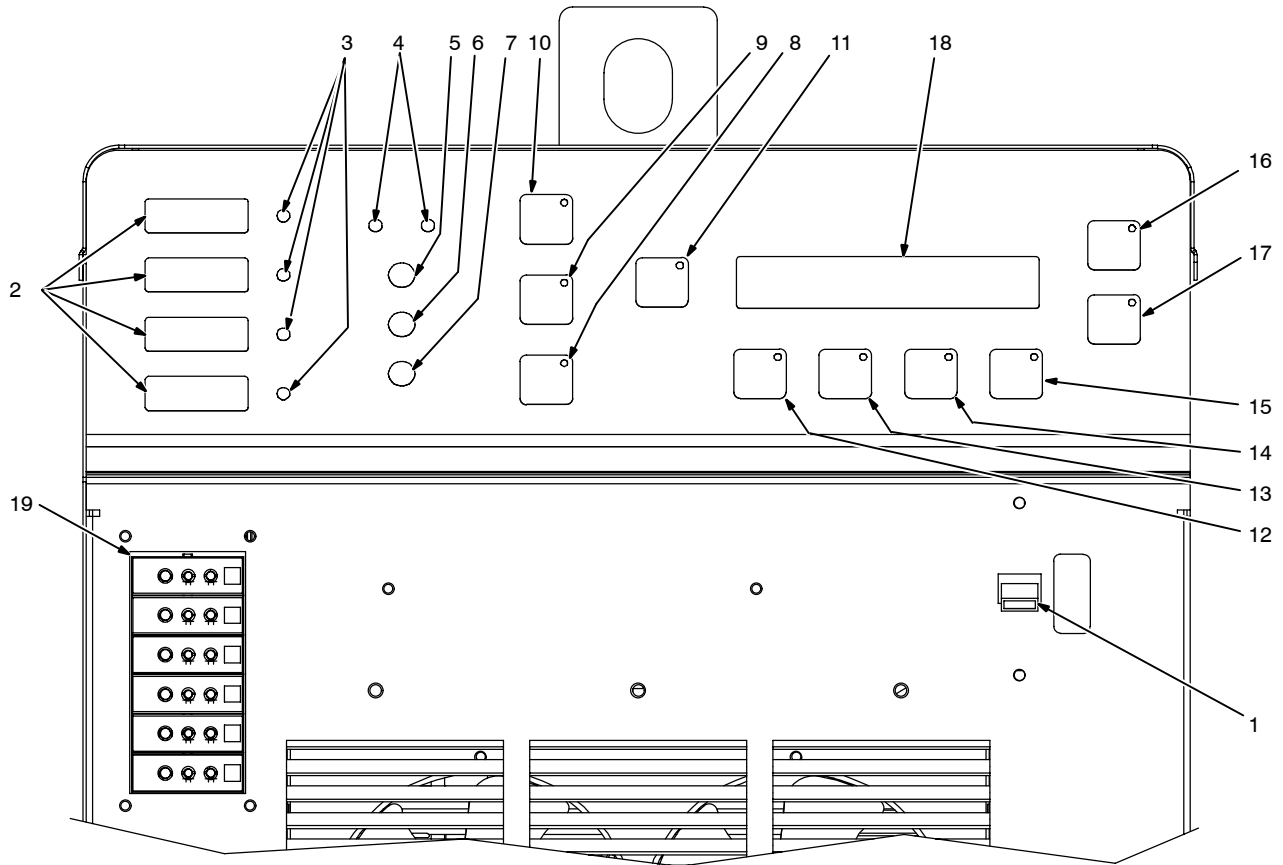

803 995-B

☞ When a control panel button is pushed the yellow lamp lights to indicate activation.

1 Power Switch

Use switch to turn power source On and Off.

2 TC1-4 Temperature Display

Provides temperature display of thermocouples 1 through 4.

3 Control Thermocouple LED's

LED's indicate which thermocouples (1-4) are used to control the heating process.

4 Temperature Units LED's

LED's indicate units for temperature measurements (°F or °C).

5 Fault LED

LED lights to indicate a system fault condition.

6 Limit LED

LED lights to indicate a system limit condition.

7 Heat On LED

LED lights to indicate the power source output is energized.

8 Stop Button

Use button to stop a heating process.

9 Hold Button

Use button to hold a heating process.

10 Run Button

Use button to run a heating process.

11 Cursor Button

Use button to move selection cursor in the 4 x 40 LCD display (item 18).

12 Program Button

Use button to program the process control.

13 Run Status Button

Use button to display real time operating status.

14 Parameter Button

Use button to display real time power source operating parameters.

15 Cooler Button

Use button to turn cooler On and Off.

16 Increase Button

Use button to increase values in set-up screen.

17 Decrease Button

Use button to decrease value in program screen.

18 4 x 40 LCD Display





Displays programming, runs status, parameter, fault and limit conditions, and troubleshooting guide.

19 Thermocouple Input Receptacles

Use receptacles for type K thermocouple inputs.

SECTION 6 – SETUP AND OPERATION

6-1. Safety Equipment



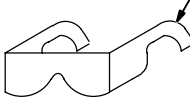
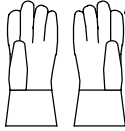

Wear the following during operation:

- 1 Dry, Insulating Gloves
- 2 Safety Glasses With Side Shields

DO NOT wear rings or watches during operation.

sb3.1* 1/94

6-2. System Description

The ProHeat 35 Induction Heating Power Source is designed to function either as an air-cooled system or a liquid-cooled system. Depending on the system type (either air-cooled or liquid-cooled), the power source is automatically configured to operate and provide an output appropriate for the type of connected heating device.



A special identifier, embedded within the extension cable connector, provides the means for the power source to configure itself by recognizing the type of extension cable(s) attached to its output connectors.

Designed to provide a single level of output (up to 35 kW), the ProHeat 35 power source has two panel mounted connectors that are connected in parallel to the power source output. This design allows the system to operate with either a single output extension cable or two output extension cables.

If a single output extension cable is used, a protective plug (provided with the system) **MUST** be placed on the unused output connector or the system will not operate. If two output extension cables are used, they both **MUST** be of the same type (either both air-cooled or both liquid-cooled) or the system will not operate (in this case, the protective plug is not used). When two extension cables and heating devices are utilized on the system, the extension cable lengths and heating devices **MUST** be identical (see Section 4-7).

The ProHeat 35 is intelligent to the point that it will automatically adjust output power levels if internal system operating parameters or internal temperatures reach or exceed specific set limits (see Section 9).

6-3. Power Source/System Setup



To view the System Setup screen, simultaneously press the Parameters  and Program  buttons and the following screen will appear on the display:

System Setup Screen

Degree Units: >°F	SYSTEM SETUP
Tolerance...: ±25	Backlight: Yes
Input Type...: K TC	Control Mode: Manual
Power Output: 35 KW	System Lock: No

To change a setting:

- Press the Cursor  button to move the cursor to the parameter to be changed

- Press Increase  or Decrease  button to select desired set-up feature.

Possible selections:

Degree Units: °F / °C

Tolerance: ±5 to 99 in °F (±3 to 55 in °C)



Backlight: Yes / No

Input Type: K TC

Control Mode: Temp / Time / Manual

Power Output: 1 to 35

System Lock: Yes / No

Degree Units – press the Increase  or Decrease  buttons to select temperature units. Selection will drive the °F / °C indicator LED's.



- The factory default is °F.
- Changing from °F to °C will convert stored program values: ramp temperature, soak temperature, ramp rate, and temperature tolerance.

Tolerance – press the Increase  or Decrease  button to select the desired temperature tolerance.



- The factory default is ±25 °F.

Backlight – press the Increase  or Decrease  button to turn LCD display backlight On or Off.

- The factory default is On.

Input Type – press the Increase  or Decrease  button to select the desired temperature input device.



- The factory default and only selection is K TC.

Control Mode – press the Increase  or Decrease  button to select the desired method of system control, either Temperature or Manual. For more details about methods of control, see Section 6-4.

- The factory default is temperature based control.





Power Output – press the Increase  or Decrease  button to adjust the maximum power source output.

- The factory default is 35 kW.

System Lock – press the Increase  or Decrease  button to lock or unlock the operator interface to prevent tampering with any programs. Yes indicates the system is locked, and No indicates the system is unlocked.

- The factory default is No (unlocked).

 All parameters in System Setup are considered global, and any changes to the system set-up parameters will apply to all programs.

To reset the system back to factory default settings, turn off the power source, and wait until the display goes blank. Turn on the power source. When the display lights, press and hold the Increase  and Decrease  buttons. A message will display Press Program to reset factory defaults. Release the Increase  and Decrease  buttons, and press the Program  button.

6-4. Programming

Programming allows the operator to setup a program for a particular heating process. The selections available are either Temperature control or Manual control.

6-4-1. Temperature-Based Control

Temperature-based control operates the system and controls the heating process based on temperature feedback from thermocouple inputs. Thermocouples must be used for this mode of operation or the system will not operate. Within the temperature-based mode there are four different processes available as follows: Preheat, Bakeout, PWHT (Post-Weld Heat Treat), and Custom Program.

Press the Program button to access the programming mode. Use the cursor button to move the cursor to the desired temperature-based process, then press the Program button again to select the process.

6-4-1-1. Preheat

The preheat process is a simple method of heating material to a desired temperature and holding that temperature for a specific period of time. When this process is selected, the following screen will appear on the LCD display:



Preheat Screen



Mode.....: Preheat

Control TC.: 1

Temperature: 400

Soak Time..: 01:00:00

The default position of the cursor is next to Control TC. Press the Increase  or Decrease  button to select the number of control thermocouples to be used for the program. Selections are as follows: 1, 1,2, 1,2,3, or 1,2,3,4. TC1 **MUST** always be a control thermocouple. TC2 thru TC4 can be used for controlling or monitoring. When a thermocouple is selected as control, the LED adjacent to the seven-segment display illuminates.

Use the Cursor  button to move the cursor to the desired selection (Temperature or Soak Time), and press the Increase  or Decrease  button to change the value to the desired setting.

 The minimum and maximum temperature settings for preheat are 0 and 1000 °F (-18 and 538 °C). The minimum and maximum soak times are 0 and 1000 hours. When the system is utilizing air-cooled blankets, the maximum temperature setting is 400 °F (204 °C). If the program setting is above 400 °F (204 °C), the following screen will appear on the LCD display when the Run button is pressed:

Maximum Temperature Message Screen

Cannot enter Run mode

Programmed temperature settings

exceed air cooled limits

(400 °F, 204 °C)

6-4-1-2. Bake-Out

The bake-out process allows the operator to program a temperature and soak time as well as a cooling rate from bake-out if desired. When this process is selected, the following screen appears on the display:



Bake-Out Screen



Mode.....: Bake-Out

Control TC:>1

Soak Temp.: 600 Soak Time: 01:00:00

Cool Temp.: 200 Cool Rate: 600 °/Hr

The default position of the cursor is next to Control TC. Press the Increase  or Decrease  button to select the number of control thermocouples to be used for the program. Selections are as follows: 1, 1,2, 1,2,3, or 1,2,3,4. TC1 **MUST** always be a control thermocouple. TC2 thru TC4 can be used for controlling or monitoring. When a thermocouple is selected as control, the LED adjacent to the seven-segment display illuminates.

Use the Cursor  button to move the cursor to the desired selection (Soak Temperature, Soak Time, Cool Temperature, or Cool Rate), and press the Increase  or Decrease  button to change the value to the desired setting.

 *The minimum and maximum soak temperature settings for bake-out are 0 and 1000 °F(-18 and 538 °C). The minimum and maximum soak times are 0 and 1000 hours. The minimum and maximum cool rates are 10 and 9999 %/hr. When the system is utilizing air-cooled blankets, the maximum temperature setting is 400 °F(204 °C). If the program setting is above 400 °F (204 °C), the following screen will appear on the LCD display when the Run button is pressed:*

Maximum Temperature Message Screen

Cannot enter Run mode

Programmed temperature settings

exceed air cooled limits

(400 °F, 204 °C)

6-4-1-3. PWHT (Post-Weld Heat Treat)

The post-weld heat treat process allows the operator to program a post-weld heat treat where ramp temperature (on increase and decrease) and ramp rates are the same. When this process is selected, the following screen appears on the display:



PWHT Screen



Mode.....: PWHT

Control TC:>1,2

Ramp Temp.: 200 Ramp Rate: 600 °/Hr

Soak Temp.: 400 Soak Time: 01:00:00

The default position of the cursor is next to Control TC. Press the Increase  or Decrease  button to select the number of control thermocouples to be used for the program. Selections are as follows: 1, 1,2, 1,2,3, or 1,2,3,4. TC1 **MUST** always be a control thermocouple. TC2 thru TC4 can be used for controlling or monitoring. When a thermocouple is selected as control, the LED adjacent to the seven-segment display illuminates.

Use the Cursor  button to move the cursor to the desired selection (Ramp Temperature, Ramp Rate, Soak Temperature, or Soak Time), and press the Increase  or Decrease  button to change the value to the desired setting.

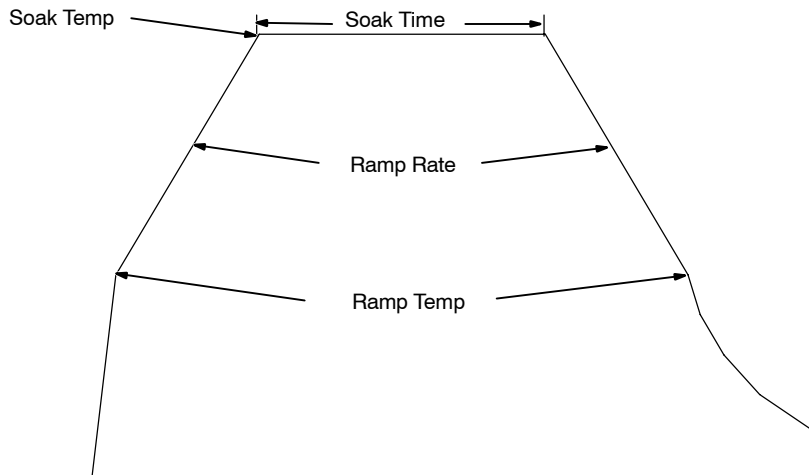

Figure 6-1. Soak Parameters

☞ The minimum and maximum ramp temperature settings for PWHT are 0 and 1450 °F (-18 and 788 °C). The minimum and maximum ramp rates are 10 and 9999 °F/hr (6 and 5555 °C/hr). The minimum and maximum soak temperatures are 0 and 1450 °F (-18 and 788 °C). The minimum and maximum soak times are 0 and 100 hours. When the system is utilizing air-cooled blankets, the maximum temperature setting is 400 °F (204 °C). If the program setting is above 400 °F (204 °C), the following screen will appear on the LCD display when the Run button is pressed.

Maximum Temperature Message Screen
 Cannot enter Run mode
 Programmed temperature settings
 exceed air cooled limits
 (400 °F, 204 °C)



6-4-1-4. Custom Program



In Custom Program, the operator can create a custom program with multiple steps or nonsymmetrical heat treat programs where the heating and cooling rates and temperatures are different. When this process is selected, the following screen appears on the display:



☞ This is the screen for initial use of the system. Subsequent use of custom program will revert to the last program used.

Custom Program Screen

Mode.....: Custom Program
Segment.....: 1
Type.....: End
Control TC.: 1

The default position of the cursor is next to Segment. Press the Increase  or Decrease  button to increase or decrease the segment number, unless the segment type is End. In this case, the segment number will advance to segment 1.

Use the Cursor  button to move the cursor to the desired selection (Type or Control TC), and press the Increase  or Decrease

 button to change the value to the desired setting. When the cursor is moved to the Type selection, pressing the Increase  or

Decrease  button changes the segment type to Step, Ramp, Soak, or End. The functions of each segment type are as follows:



- Step increases the temperature in the part at full-programmed power. A maximum temperature of 1450° F (788° C) can be programmed.
- Ramp increases or decreases the temperature in the part at a controlled rate in degrees per hour. A maximum temperature of 1450° F (788° C) and a maximum rate of 9999° F/hr (5555° C/hr) can be programmed.
- Soak will hold the temperature for a programmed time. A maximum hold (soak) time of 99:59 (hours:minutes) can be programmed.
- End is programmed to indicate the completion of the cycle and termination of output power.

Step Function

When type is set to Step, the following screen appears on the display:

Custom Program Screen

Mode.....: Custom Program
Segment.....: 1
Type.....:>Step
Temperature: 600

Use the Cursor  button to move the cursor to the Temperature position and the initial temperature can be adjusted using the Increase  or Decrease  button.

Pressing the Cursor  button again automatically advances the program to the next segment number.



Ramp Function

When type is set to Ramp, the following screen appears on the display:

Soak Function

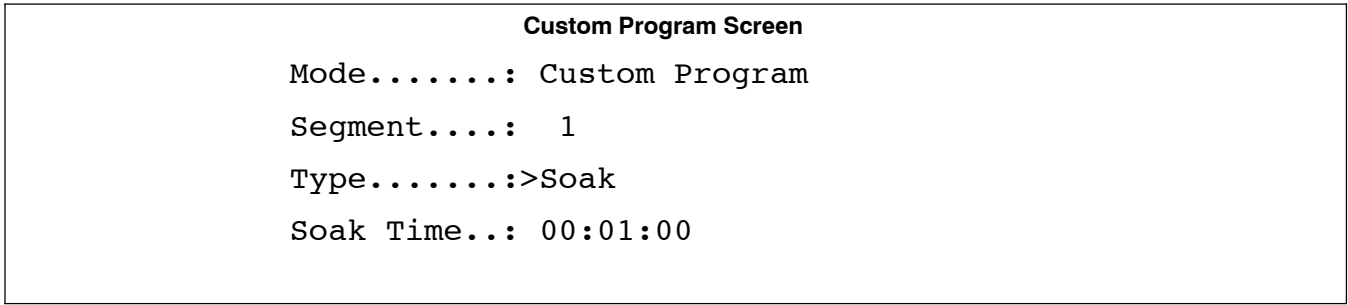
When type is set to Soak, the following screen appears on the display:







Use the Cursor  button to move the cursor to the Soak Time position and use the Increase  or Decrease  button to set the desired value.

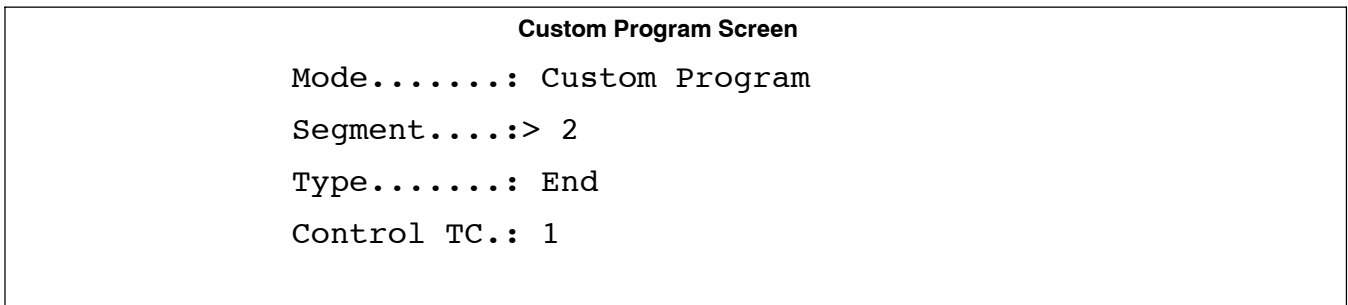

When the cursor is in the Soak Time position, pressing the Cursor  button again automatically advances the program to the next segment number.

End Function

When type is set to End, the following screen appears on the display:



The only changeable parameter in the End segment is selecting the number of thermocouples. Use the Cursor  button to move the cursor to the Control TC position. Press the Increase  or Decrease  button to select the number of control thermocouples to be used for the program. Selections are as follows: 1, 1,2, 1,2,3, or 1,2,3,4. TC1 **MUST** always be a control thermocouple. TC2 thru TC4 can be used for controlling or monitoring. When a thermocouple is selected as control, the LED adjacent to the seven-segment display illuminates.

A custom program can contain up to 10 segments. To view Program parameters, position the cursor at segment and use the Increase  or Decrease  button to advance through the segment numbers until the End segment. When a segment number is changed, appropriate segment parameter information appears on the display.

Typical 5-Segment Custom Program

```
Custom Program Screen
Mode.....: Custom Program
Segment....: 1
Type.....:>Step
Temperature: 600
```

Temperature increases to 600 degrees at full-programmed power.

```
Custom Program Screen
Mode.....: Custom Program
Segment....: 2
Type.....: Ramp
Temperature:>1250 Ramp Rate: 600 °/Hr
```

Controlled heating to 1250 degrees F at a ramp of 600 degrees per hour.

```
Custom Program Screen
Mode.....: Custom Program
Segment....: 3
Type.....: Soak
Soak Time...>01:00:00
```

Soak at 1250 degrees F for a period of 1:00.

```
Custom Program Screen
Mode.....: Custom Program
Segment....: 4
Type.....:>Ramp
Temperature: 600 Ramp Rate: 600 °/Hr
```

Controlled cooling to 600 degrees F at a rate of 600 degrees per hour.

```
Custom Program Screen
Mode.....: Custom Program
Segment....: 5
Type.....: End
Control TC.: 1
```

End segment ends the heat treat cycle. Controller is programmed to control the process using four thermocouples.

6-4-2. Manual Control

Manual control allows programming of a specific power level for a specific period of time. When this process is selected, the following screen appears on the display:

Manual Program Screen

Mode.....:	Manual	Power...:	0.0 KW
Command.:	0.0 KW	Current:	0 A
Run Time:	00:03:00	Voltage:	0 V
		Frequency:	4.5 KHz

The only programmable selections are Command power and Run Time. Command can be adjusted to deliver up to 35 KW (based on maximum power selected in the set-up screen) for a period of up to 99 hours, 59 minutes, 59 seconds.

Power source operating power, current, voltage, and frequency are shown on the right-hand side of the display.

To reset the system back to factory default settings, turn off the power source, and wait until the display goes blank. Turn on the power source. When

the display lights, press and hold the Increase  and Decrease  buttons. A message will display Press Program to reset factory

defaults. Release the Increase  and Decrease  buttons, and press the Program  button.

6-5. Run Status

Run status allows the operator to check status of a program during in-process heating. Depending on the control mode (Temperature or Manual) and the temperature based mode (Preheat, Bake-Out, PWHT, or Custom), different style screens appear on the display. Run status is for monitoring purposes only and has no selectable or changeable parameters.

6-5-1. Temperature Based Control

6-5-1-1. Preheat, Bake-Out And PWHT Run Status Screen

Run Status Screen

Mode.....:	Preheat	TC5:	77
Target Temp:	----	TC6:	77
Countdown...:	--:--:--		
Status.....:	Stopped		

Mode displays the programming mode (Preheat, Bake-Out, PWHT, or Custom Program). During active operation, Target Temp shows the target temperature based on the specific program, Countdown shows the time remaining in a soak segment, and Status shows the program segment type (step, soak, ramp, hold, or stopped). TC5 and TC6 display the temperature of thermocouples 5 and 6. This screen is for monitoring purposes only.

6-5-1-2. Custom Program

Run Status Screen

Mode.....:	Custom Program	TC5:	77
Target Temp:	----	TC6:	77
Countdown...:	--:--:--	Segment:	1
Status.....:	Stopped		

During active operation, Target Temp shows the target temperature based on the active segment, Countdown shows the time remaining in a soak segment, and Status shows the program segment type (step, soak, ramp, hold, or stopped) of the active segment and the active segment number. TC5 and TC6 display the temperature of thermocouples 5 and 6. This screen is for monitoring purposes only.

6-5-2. Manual Control

Run Status Screen			
Mode.....:	Manual	TC5:	77
Power.....:	0.0 KW	TC6:	77
Countdown:	--:--:--		
Status....:	Stopped		

During active operation, Power shows the actual power delivered from the power source, Countdown shows the time remaining in the heating cycle, and Status indicates if the system is running or stopped. TC5 and TC6 display the temperature of thermocouples 5 and 6. This screen is for monitoring purposes only.





 No changes can be made to the run status screen, and the Cursor, Increase and Decrease buttons are not functional.

6-6. Parameters

During active operation, the Parameters screen allows the operator to monitor the power source output operating parameters. These parameters include output power, output amperage, output voltage, and output frequency. In addition, temperatures of thermocouples TC5 and TC6 are also displayed. The Parameters screen is for monitoring purposes only and has no selectable or changeable parameters.

Parameters Screen			
Power.....:	0.0 KW	TC5:	77
Current...:	0 A	TC6:	77
Voltage...:	0 V		
Frequency:	4.5 KHz		

6-7. Cooler

The Cooler  button is used to turn the cooler On or Off on systems using liquid-cooled output cables. Systems using liquid-cooled output cables will not deliver output unless the cooler is On. If the cooler is not started prior to initiating a heating cycle, the system will automatically start the cooler when the Run  button is pressed. Pressing the Stop  button does not shut off the cooler. The cooler must be shut off separately by pressing the Cooler  button.

When power source output is energized, the cooler cannot be turned off. If the Cooler  button is pressed while output is energized, the following screen will appear on the display:

Cooler Message Screen	
Cooler cannot be turned off while output is on	

 The Cooler button is inactive when no cooler is detected and no liquid-cooled output cable is attached.

6-8. Real-Time Operation

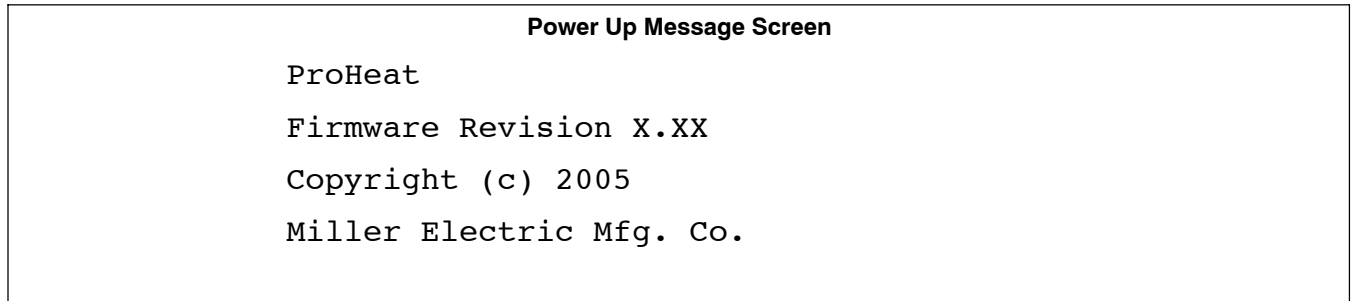

Each time the unit is first turned On it initiates a system check routine that includes verification of communication between circuit boards and checking for output isolation faults. During this check routine, all displays and LED's illuminate and the following screen appears on the display:





X.XX indicates the firmware revision number installed in the unit.

If an error is detected during the check routine, the system fault LED illuminates and an error message screen appears on the display (see Section 9-5).

When the check routine is completed successfully, the operator interface defaults to the following:

- The Stop  button indicator LED illuminates to indicate no heating cycle is in process.
- The temperature displays indicate actual temperature from the TC's (thermocouples). If no thermocouples are connected, the displays indicate OPEN.
- Control LED's illuminate to indicate the number of control TC's in the last program.
- The appropriate degree units (°F or °C) light illuminates.
- The display defaults to the Run Status screen from the last program used and the Run Status  button indicator LED illuminates.
- If no fault or limit conditions are present, system status lights are not illuminated.

Once set up is complete for the desired program procedure (see Section 6-3), pressing the Run  button will initiate a heating cycle. When a

program run is initiated, the Run  button yellow indicator LED illuminates and the Heat On blue indicator LED illuminates to indicate output is

present to the coil. The cycle will continue until the end of the program is reached or the Stop  button is pressed.

The system has a hold function that will maintain a temperature or hold the soak time of any active temperature controlled program. Pressing the Hold

 button will only activate the hold function while in the run mode. If the system is not in the run mode, the following screen will appear on the display:

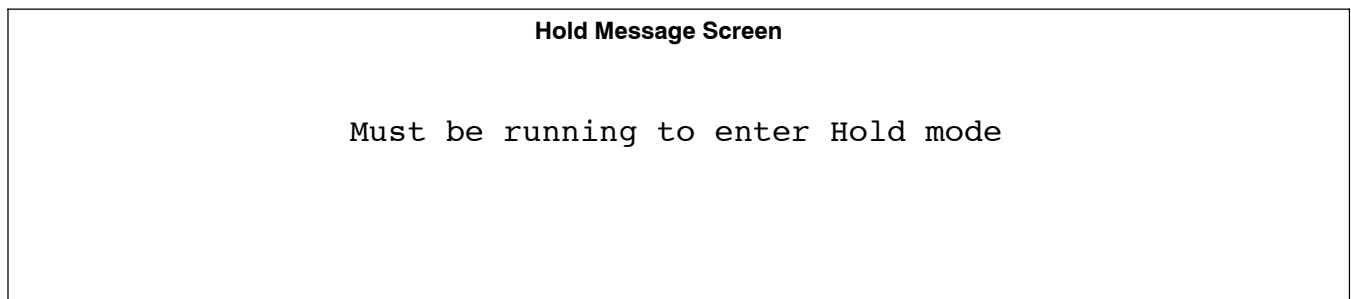

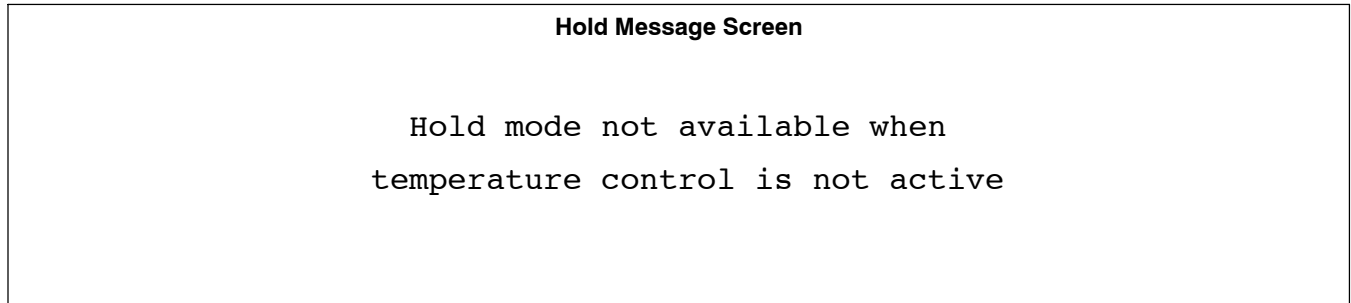

In addition, when running in Manual operating mode, the Hold  button is not functional. If the system is running in Manual operating mode,

pressing the Hold  button will cause the following screen to appear on the display:





Pressing the Hold  button will activate the hold function while running a temperature controlled program. While in the hold mode, the param-

eters for the program in process can be modified. The cycle will continue after pressing the Run  button. A change of program parameters during the hold will not change the original program. The original program parameters are maintained for the next heating cycle.

To make changes to a program while in run mode, press the Hold  button and the yellow indicator LED will illuminate, and the Run  button yellow indicator LED will turn off. When in hold, the system will maintain the actual temperature of the hottest thermocouple while the program is being changed.

- Press the Program  button and the yellow indicator LED will illuminate. The display will change to show the current mode of operation or the current segment of a Custom Program.

- Use the Cursor  button to move the cursor to the parameter that will be changed.

- Press the Increase  or Decrease  button to make desired changes.

- Press the Run  button to resume program operation and the yellow indicator LED will illuminate, and

the Hold  button yellow indicator LED will turn off.

Any program parameter (temperatures, rates, times, or number of TC's) can be changed while in hold. In a custom based program, any segment number can be changed; however, if the operation of a segment has already been completed in a program, the change to that segment will not affect the program function.

- Press the Stop  button to end the program.

6-9. System Operating Characteristics

The power source delivers a high-frequency alternating current output that energizes the coil creating the magnetic field used to heat the workpiece. The power source output characteristics are a function of the configuration, type and number of coils used as shown in the following table:



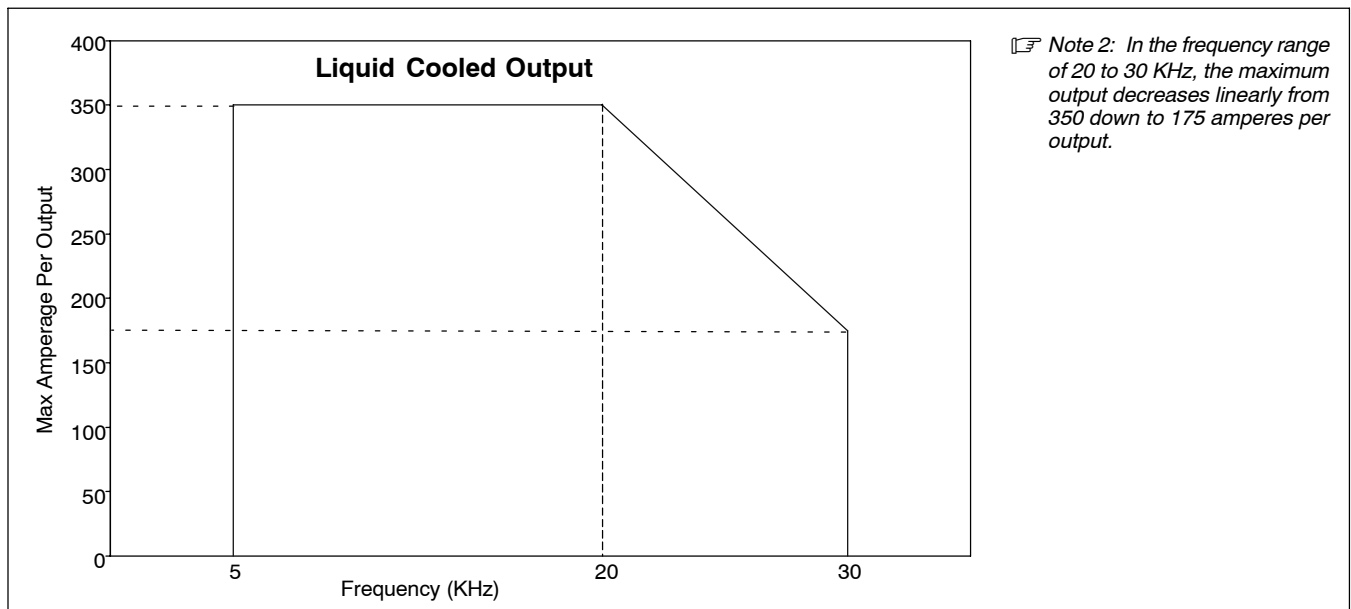
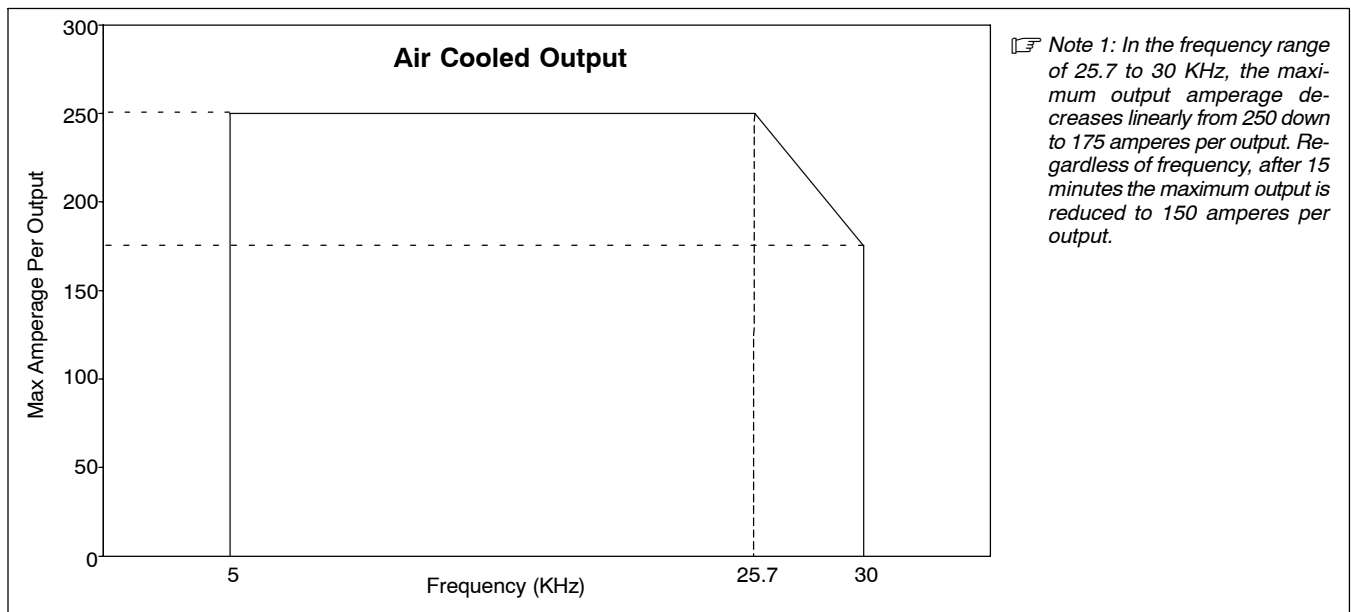

Table 6-1. Power Source Output Characteristics



Output Type	Maximum Amperage	Maximum Voltage	Frequency Range
Air Cooled Single and Dual	250 A per output for 15 minutes. After 15 minutes, power steps down to limit current to 150 amperes per output for continuous operation.	700 V	5 – 25.7 kHz
	See Note 1	700 V	25.7 – 30 kHz
Single Liquid Cooled	350 A	700 V	5 – 20 kHz
	See Note 2	700 V	20 – 30 kHz
Dual Liquid Cooled	350 A per output/700 A total	700 V	5 – 20 kHz
	See Note 2	700 V	20 – 30 kHz

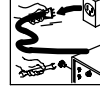

SECTION 7 – MAINTENANCE

7-1. Routine Maintenance

						<p>⚠ Disconnect power before maintaining.</p> <p><i>☞ Maintain more often during severe conditions.</i></p>
---	---	---	---	---	---	--

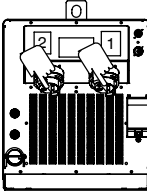
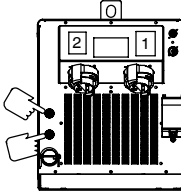
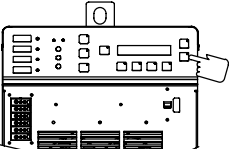
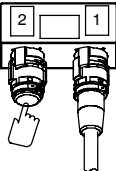
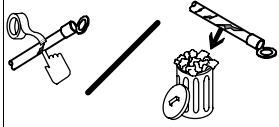
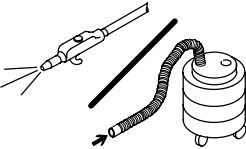
		<p>✓ = Check ◇ = Change ● = Clean ☆ = Replace</p> <p>* To be done by Factory Authorized Service Agent</p>		Reference	
Every 3 Months	 				Section 4-7, 4-12
	<p>☆ Damaged or Unreadable Labels</p>	<p>● Output Connector Contacts</p>	<p>● Ground Sense Lead Receptacles</p>	<p>● Operator Interface Overlay</p>	
Every 6 Months					Section 9-8
	<p>✓ Integrity Of Protective Plug, Replace If Necessary</p>	<p>✓ ☆ Cracked Cables</p>			
					
	<p>● Inside Unit</p>				

SECTION 8 – SAFETY PRECAUTIONS FOR SERVICING

 Protect yourself and others from injury — read and follow these precautions.

8-1. Symbol Usage

OM-222166J - 2007-06, safety_ihtm 2007-04

 **DANGER!** – Indicates a hazardous situation which, if not avoided, will result in death or serious injury. The possible hazards are shown in the adjoining symbols or explained in the text.

 Indicates a hazardous situation which, if not avoided, could result in death or serious injury. The possible hazards are shown in the adjoining symbols or explained in the text.

NOTICE – Indicates statements not related to personal injury.

 Indicates special instructions.



This group of symbols means Warning! Watch Out! ELECTRIC SHOCK, MOVING PARTS, and HOT PARTS hazards. Consult symbols and related instructions below for necessary actions to avoid the hazards.

8-2. Servicing Hazards

 The symbols shown below are used throughout this manual to call attention to and identify possible hazards. When you see the symbol, watch out, and follow the related instructions to avoid the hazard.

 Only qualified persons should service, test, maintain, and repair this unit.

 During servicing, keep everybody, especially children, away.



ELECTRIC SHOCK can kill.

- Do not touch live electrical parts.
- Turn Off induction heating power source and disconnect and lockout input power using line disconnect switch, circuit breakers, or by removing plug from receptacle, or stop engine before servicing unless the procedure specifically requires an energized unit.

- Insulate yourself from ground by standing or working on dry insulating mats big enough to prevent contact with the ground.
- Do not leave live unit unattended.
- If this procedure requires an energized unit, have only personnel familiar with and following standard safety practices do the job.
- When testing a live unit, use the one-hand method. Do not put both hands inside unit. Keep one hand free.
- Disconnect input power conductors from deenergized supply line BEFORE moving an induction heating power source.

SIGNIFICANT DC VOLTAGE exists after removal of input power on inverters.

- Turn Off inverter, disconnect input power, and discharge input capacitors according to instructions in Troubleshooting Section before touching any parts.

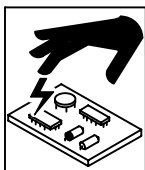

STATIC (ESD) can damage PC boards.

- Put on grounded wrist strap BEFORE handling boards or parts.
- Use proper static-proof bags and boxes to store, move, or ship PC boards.



FIRE OR EXPLOSION hazard.

- Do not place unit on, over, or near combustible surfaces.
- Do not service unit near flammables.

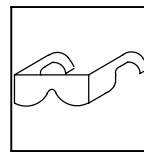

FLYING METAL or DIRT can injure eyes.

- Wear safety glasses with side shields or face shield during servicing.
- Be careful not to short metal tools, parts, or wires together during testing and servicing.

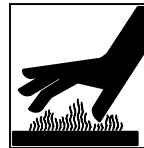

HOT PARTS can cause severe burns.

- Do not touch hot parts bare handed.
- Do not touch or handle induction head/coil during operation.
- Keep metal jewelry and other metal personal items away from head/coil during operation.
- Allow cooling period before working on equipment.
- To handle hot parts, use proper tools and/or wear heavy, insulated welding gloves and clothing to prevent burns.

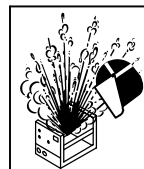

EXPLODING PARTS can cause injury.

- Failed parts can explode or cause other parts to explode when power is applied to inverters.
- Always wear a face shield and long sleeves when servicing inverters.

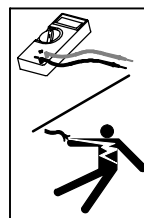

SHOCK HAZARD from testing.

- Turn Off induction heating power source before making or changing meter lead connections.
- Use at least one meter lead that has a self-retaining spring clip such as an alligator clip.
- Read instructions for test equipment.



FALLING UNIT can cause injury.

- Use lifting eye to lift unit only, NOT running gear, gas cylinders, or any other accessories.
- Use equipment of adequate capacity to lift and support unit.
- If using lift forks to move unit, be sure forks are long enough to extend beyond opposite side of unit.



MOVING PARTS can cause injury.

- Keep away from moving parts such as fans.
- Have only qualified persons remove doors, panels, covers, or guards for maintenance as necessary.
- Keep hands, hair, loose clothing, and tools away from moving parts.
- Reinstall doors, panels, covers, or guards when maintenance is finished and before reconnecting input power.



MAGNETIC FIELDS can affect Implanted Medical Devices.

- Wearers of Pacemakers and other Implanted Medical Devices should keep away from servicing areas until consulting their doctor and the device manufacturer.

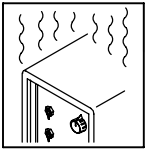

OVERUSE can cause OVERHEATING.

- Allow cooling period; follow rated duty cycle.
- Reduce current or reduce duty cycle before using induction heating equipment again.
- Do not block or filter airflow to unit.

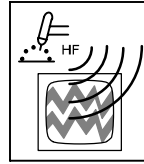

H.F. RADIATION can cause interference.

- High-frequency (H.F.) can interfere with radio navigation, safety services, computers, and communications equipment.
- Have only qualified persons familiar with electronic equipment install, test, and service H.F. producing units.
- The user is responsible for having a qualified electrician promptly correct any interference problem resulting from the installation.
- If notified by the FCC about interference, stop using the equipment at once.
- Have the installation regularly checked and maintained.
- Keep high-frequency source doors and panels tightly shut, keep spark gaps at correct setting, and use grounding and shielding to minimize the possibility of interference.

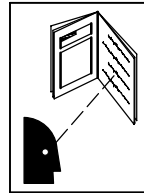

READ INSTRUCTIONS.

- Use Testing Booklet (Part No. 150 853) when servicing this unit.
- Consult the Owner's Manual for induction heating safety precautions.
- Use only genuine replacement parts from the manufacturer.

8-3. California Proposition 65 Warnings

- ⚠ **Welding or cutting equipment produces fumes or gases which contain chemicals known to the State of California to cause birth defects and, in some cases, cancer. (California Health & Safety Code Section 25249.5 et seq.)**
- ⚠ **Battery posts, terminals and related accessories contain lead and lead compounds, chemicals known to the State of California to cause cancer and birth defects or other reproductive harm. Wash hands after handling.**

For Gasoline Engines:

- ⚠ **Engine exhaust contains chemicals known to the State of California to cause cancer, birth defects, or other reproductive harm.**

For Diesel Engines:

- ⚠ **Diesel engine exhaust and some of its constituents are known to the State of California to cause cancer, birth defects, and other reproductive harm.**

8-4. EMF Information

Considerations About Induction Heating And The Effects Of Low Frequency Electric And Magnetic Fields

Induction heating current, as it flows through induction heating cables, will cause electromagnetic fields. There has been and still is some concern about such fields. However, after examining more than 500 studies spanning 17 years of research, a special blue ribbon committee of the National Research Council concluded that: "The body of evidence, in the committee's judgment, has not demonstrated that exposure to power-frequency electric and magnetic fields is a human-health hazard." However, studies are still going forth and evidence continues to be examined. Until the final conclusions of the research are reached, you may wish to minimize your exposure to electromagnetic fields when using induction heating equipment.

To reduce magnetic fields in the workplace, use the following procedures:

1. Keep cables close together by twisting or taping them, or using a cable cover.

2. Arrange cables to one side and away from the operator.

3. Do not coil or drape cables around your body.

4. Keep induction heating power source and cables as far away from operator as practical.

5. Connect work clamp to workpiece as close to the weld as possible.

About Implanted Medical Devices:

Implanted Medical Device wearers should consult their doctor and the device manufacturer before performing or going near arc welding, spot welding, gouging, plasma arc cutting, or induction heating operations. If cleared by your doctor, then following the above procedures is recommended.

SECTION 9 – DIAGNOSTICS & TROUBLESHOOTING

The ProHeat 35 power source has on-board capabilities to aid in troubleshooting problems should any conditions occur during operation. This troubleshooting capability consists of the Fault LED, Limit LED, and message screens that appear on the front panel LCD display.

9-1. Operator Interface Indicators

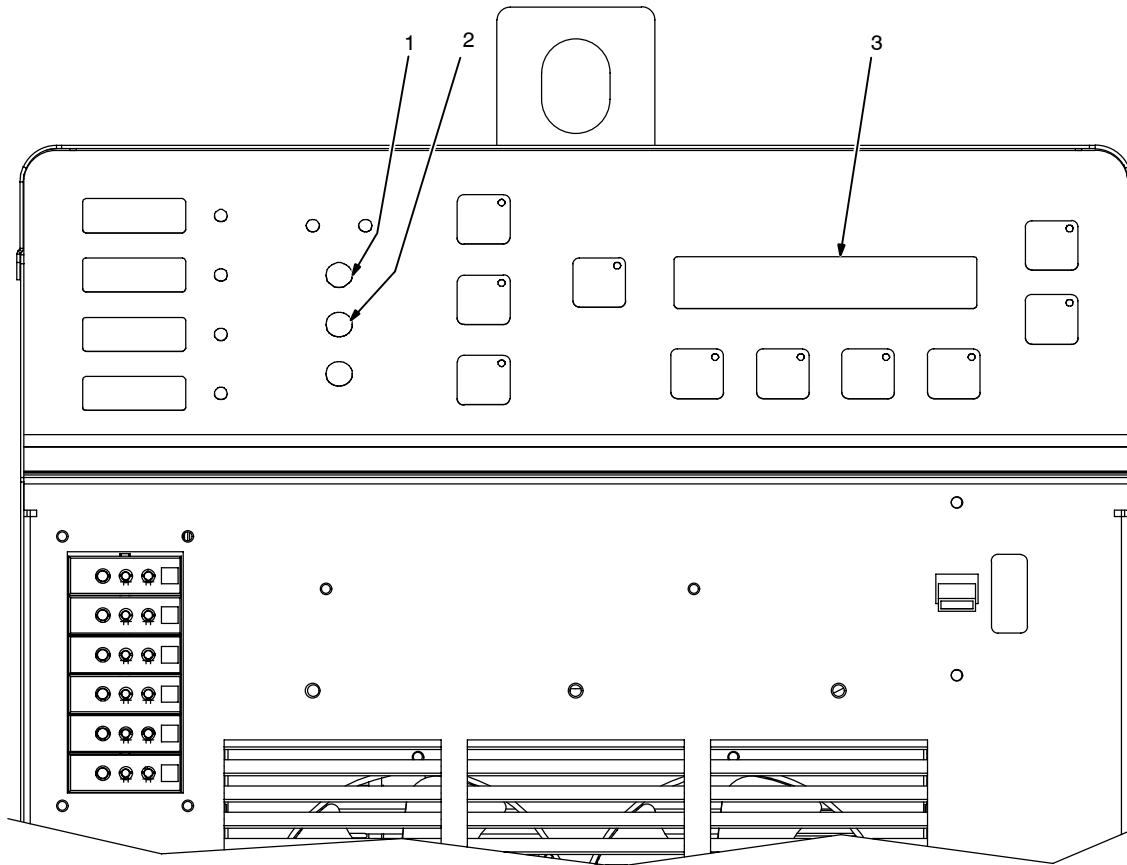

803 995-B

1 Fault LED

LED lights to indicate a system fault condition.

2 Limit LED

LED lights to indicate a system limit condition.

3 4 x 40 LCD Display

Displays programming, run status, parameters, fault and limit conditions, and troubleshooting guide.

9-2. Limit Conditions

A limit condition indicates that the system has encountered an open thermocouple or is outside the range of its optimum operating conditions or parameters. Should a limit condition occur during operation, the yellow Limit LED will flash to indicate a problem. If the active screen on the LCD display is Run Status or Parameters, a message describing the particular limit condition will appear on the display. If the active screen is Program, press the

Run Status  button to display the limit condition.



In a limit condition, the power source will continue to deliver output power and protect itself from damage by reducing the output power. This situation allows the operator time to determine the best action to correct the problem as described by the limit message on the LCD display.

If a limit condition occurs, there are two selectable options:

- Acknowledge the limit and continue operation.
- Terminate operation to correct the problem causing the limit.



Pressing the Decrease  button will acknowledge the limit and continue operation with the existing set up. In the acknowledge state, the yellow

Limit LED will stop flashing and remain on continuously. The LCD display will revert to an active screen once the Program  button, Run Status

 button, or Parameters  button is pressed.

If a new limit condition should occur after the first is acknowledged, the yellow Limit LED will start flashing to indicate a new problem. To display the limit condition, press the Run Status  button and the LCD display will show a message describing the new and previous limit messages.

To obtain additional information regarding the limit condition and suggested solutions to resolve the limit, press the Increase  button, and the LCD display will indicate possible solutions based on the type of limit condition.



If the operator determines that the best course of action is to terminate operation and make suggested changes to the setup to eliminate the limit condition, press the Stop  button. After changes are made to the setup, press the Run  button to restart the process.



9-3. Limit Condition Codes

Limit Condition	Additional Information
L01: Thermocouple #1 Open	Check for open temperature sensor and repair Change to back-up temperature sensor
L02: Thermocouple #2 Open	Check for open temperature sensor and repair Change to back-up temperature sensor
L03: Thermocouple #3 Open	Check for open temperature sensor and repair Change to back-up temperature sensor
L04: Thermocouple #4 Open	Check for open temperature sensor and repair Change to back-up temperature sensor
L05: Thermocouple #5 Open	Check for open temperature sensor and repair Change to back-up temperature sensor
L06: Thermocouple #6 Open	Check for open temperature sensor and repair Change to back-up temperature sensor
L07: Output Voltage Limit	Tighten blanket against pipe surface
L08: Output Voltage Limit	Increase number of turns Increase coil space Shorten extension cable Increase insulation width
L09: Output Current Limit	Tighten blanket against pipe surface
L10: Output Current Limit	Increase number of turns Decrease coil space Tighten cable on insulation

Limit Condition	Additional Information
L11: Coolant Overtemp Limit	Check coolant flow and level Clean coolant filters and heat exchanger Increase number of turns Verify appropriate insulation thickness
L12: Power Source Overtemp Limit	Check for blocked vents Clean wind tunnel heat sinks
L13: Cable Connection	Check for loose/open output connection Verify all output cables are same type Verify receptacle plug connected

9-4. Fault Conditions

A fault condition occurs if the system encounters an isolation fault, encounters operating conditions outside operational limits, or if there is a serious problem with the system. Should a fault condition occur, the output is immediately turned off, the red Fault LED flashes and the Stop  button LED flashes. If the active screen on the LCD display is Run Status or Parameters, a message describing the particular fault condition will appear on the display. If the active screen is Program, press the Run Status  button to display the fault condition.

Pressing the Decrease  button will acknowledge the fault and the red Fault LED will stop flashing and remain on continuously. However, the Stop  button LED will continue to flash indicating that the process has stopped.

To obtain additional information regarding the fault condition and suggested solutions to resolve the fault, press the Increase  button, and the LCD display will indicate possible solutions based on the type of fault condition. In most cases, a fault condition will indicate that service is required.



9-5. Fault Condition Codes

Fault Condition	Additional Information
F51: Thermocouple #1 Internal Fault	Service required
F52: Thermocouple #2 Internal Fault	Service required
F53: Thermocouple #3 Internal Fault	Service required
F54: Thermocouple #4 Internal Fault	Service required
F55: Thermocouple #5 Internal Fault	Service required
F56: Thermocouple #6 Internal Fault	Service required
F57: CJT Sensor Internal Fault	Service required
F58: Output Voltage Fault	Service required
F59: Output Current Fault	Service required
F60: Temperature Sensor Fault	Check control TC connections Check control TC extension cable
F61: Coolant Flow Fault	Check for coolant leak Clean for coolant blockage Check coolant filter and level Check coolant connections
F62: Isolation Fault	Check for exposed conductor Clean for moisture on cables
F63: Line Voltage Fault	Check line voltage
F64: Power Source Overtemp Fault	Verify power source vents and wind tunnel are unobstructed
F65: Current Source Fault	Service required
F66: Under Frequency Fault	Check for loose or open connections in output cable Decrease number of turns Decrease coil space

Fault Condition	Additional Information
F67: Over Frequency Fault	Verify heating cable properly wrapped Verify material being heated is magnetic
F68: Cable Connection Fault	Check for loose/open output connection Verify all output cables are same type Verify receptacle plug connected
F69: Coolant Overtemp Fault	Check coolant flow and level Clean coolant filters and heat exchanger Increase number of turns Verify appropriate insulation thickness
F70: Internal Communication Fault	Service required
F71: Internal Thermistor Fault	Service required
F72: Coolant Thermistor Fault	Service required
F73: Decoupled/Open Coil	Service required
F74: Isolation Fault Self-Test Error	Service required
F75: Internal Power Supply Fault	Service required
F76: Current Source Control Fault	Service required
F77: Power Source Internal Comm Fault	Service required
F78: Output Current Sense Fault	Check for loose/open output connection

9-6. System Diagnostic Screens

Additional system diagnostics are available and accessible through the operator interface. Detail operational parameters can be accessed by pressing

and holding the Run Status  button and pressing the Parameters  button.

When this feature is initially activated, the following screen appears on the LCD display:

System Diagnostic Screen			
RemCmd:	1023	Off	Cable1: LQD DIAG1
OutI1:	0	A	Cable2: LQD
OutI2:	0	A	ClntFR: 0.75 GPM
IsrcFb:	0	A	ClrSts: Flowing

RemCmd – This is the value of the remote command and the status of the remote contactor.

 Remote controls can be used to enable/disable output. They do not affect output power level.

Out I1 – This is the value of the output current on output 1.

Out I2 – This is the value of the output current on output 2.

Isrc FB – This is the value of the amperage in the current source inverter.

Cable 1 – This is the cable type hooked up to output number one. Possible labels:

- AIR – for an air-cooled cable
- LQD – for a liquid-cooled cable
- PLUG – for a protective plug
- OPEN – no cable or plug in place

Cable 2 – This is the cable type hooked up to output number two. Possible labels:

- AIR – for an air-cooled cable
- LQD – for a liquid-cooled cable
- PLUG – for a protective plug

- OPEN – no cable or plug in place

ClntFR – This is the coolant flow rate (in GPM) from the cooler on a liquid-cooled system.

ClrSts – This is the status of the cooler. Possible labels:

- Off
- Flowing

The second diagnostic screen is available by again pressing and holding the Run Status



button and pressing the Parameters



button.

System Diagnostic Screen				
VLnA-B:	460V	Therm1:	75	DIAG2
VLnB-C:	460V	Therm2:	75	Therm5: OPEN
VLnC-A:	460V	Therm3:	75	ClrTmp: 77
VBus:	650V	Therm4:	OPEN	RmtFlw: Off

VLnA-B – This is the phase to phase line voltage between phases A and B.

VLnB-C – This is the phase to phase line voltage between phases B and C.

VLnC-A – This is the phase to phase line voltage between phases C and A.

VBus – This is the DC bus voltage.

Therm1 – This is the temperature of the current source primary heatsink.

Therm2 – This is the temperature of the bridge heatsink.

Therm3 – This the the temperature of the current source secondary heatsink.

Therm4 – Open (not used).

Therm5 – Open (not used).

ClrTmp – This is the temperature of the coolant on a liquid-cooled system.

- OPEN – no cooler is detected.

RmtFlw – This is the status of the relay contacts for remote coolant flow on a liquid-cooled system.

- OFF
- ON

 RmtFlw feature is unsupported on the current platform.

9-7. Removing Wrapper and Measuring Input Capacitor Voltage



Tools Needed:

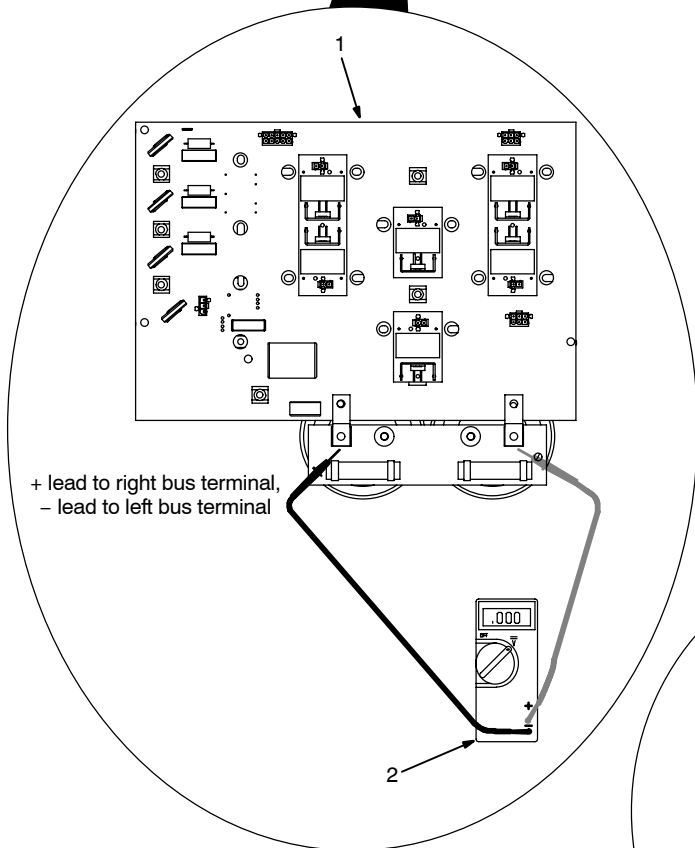
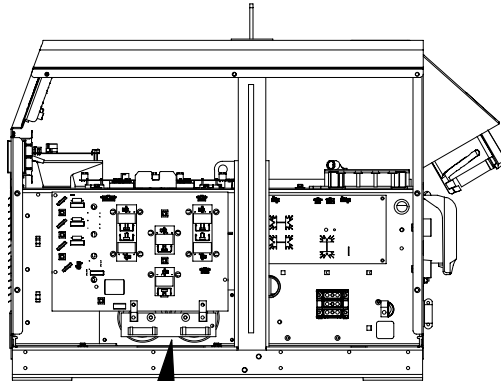
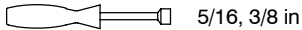

+ lead to right bus terminal,
- lead to left bus terminal

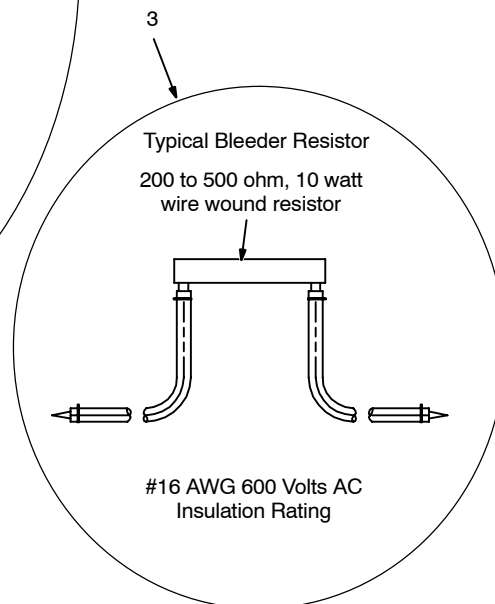

⚠ 900 Volts dc can be present on the capacitor bus and significant DC voltage can remain on capacitors after unit is Off. Always check the voltage on inverter assembly as shown to be sure the input capacitors have discharged before working on unit.

⚠ Turn Off welding power source, and disconnect input power.

⚠ Significant DC voltage can remain on capacitors after unit is Off. Always check the voltage as shown to be sure the input capacitors have discharged before working on unit.

Remove right side panel and disconnect fan motor FM3.

- 1 Current Source Interconnect Board PC4
- 2 Voltmeter

Measure the dc voltage across the + bus terminal and - bus terminal on PC4 as shown until voltage drops to near 0 (zero) volts.

☞ If the capacitor voltage does not drop to near zero after several minutes, use a bleeder resistor of between 200 and 500 ohms, at least 10 watts, and #16 AWG 600 volts ac insulation rated wire to discharge the capacitor(s).



- 3 Typical Bleeder Resistor

An example of a typical bleeder resistor is shown on this page.

Proceed with job inside unit. Reconnect FM3 and reinstall right side panel when finished.

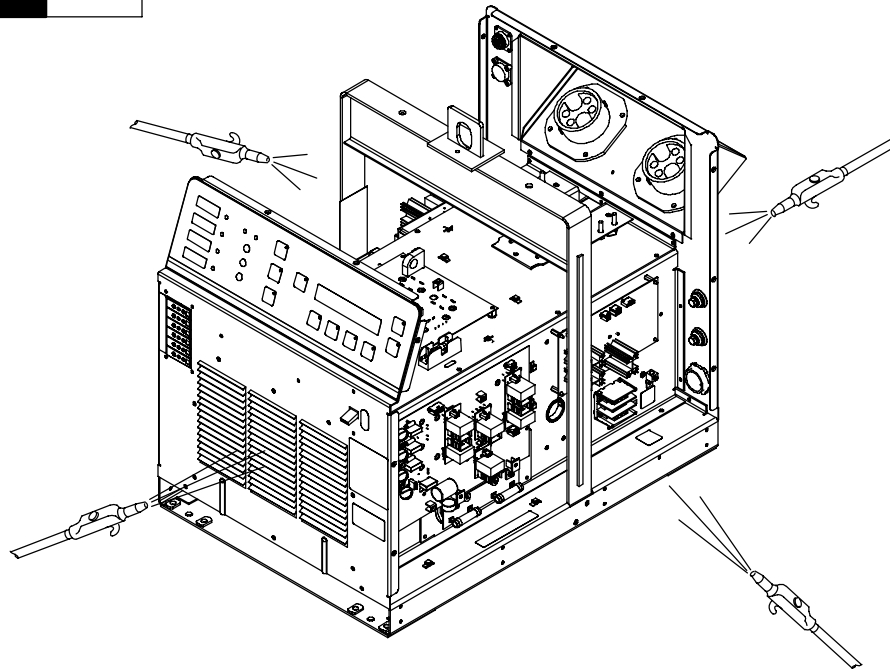
9-8. Blowing Out Inside Of Unit













-  Turn Off welding power source and disconnect input power.
-  Remove wrapper and be sure input capacitors are discharged.

Blow out inside of unit. Blow out fan motors in right side panel and front panel.

804 625-B

Notes

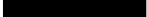
MATERIAL THICKNESS REFERENCE CHART

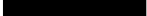
	24 Gauge (.025 in)
	22 Gauge (.031 in)
	20 Gauge (.037 in)
	18 Gauge (.050 in)
	16 Gauge (.063 in)
	14 Gauge (.078 in)
	1/8 in (.125 in)
	3/16 in (.188 in)
	1/4 in (.25 in)
	5/16 in (.313 in)
	3/8 in (.375 in)
	1/2 in (.5 in)

SECTION 10 – ELECTRICAL DIAGRAM



- WARNING**
- Do not touch live electrical parts.
 - Disconnect input power or stop engine before servicing.
 - Do not operate with covers removed.
 - Have only qualified persons install, use, or service this unit.

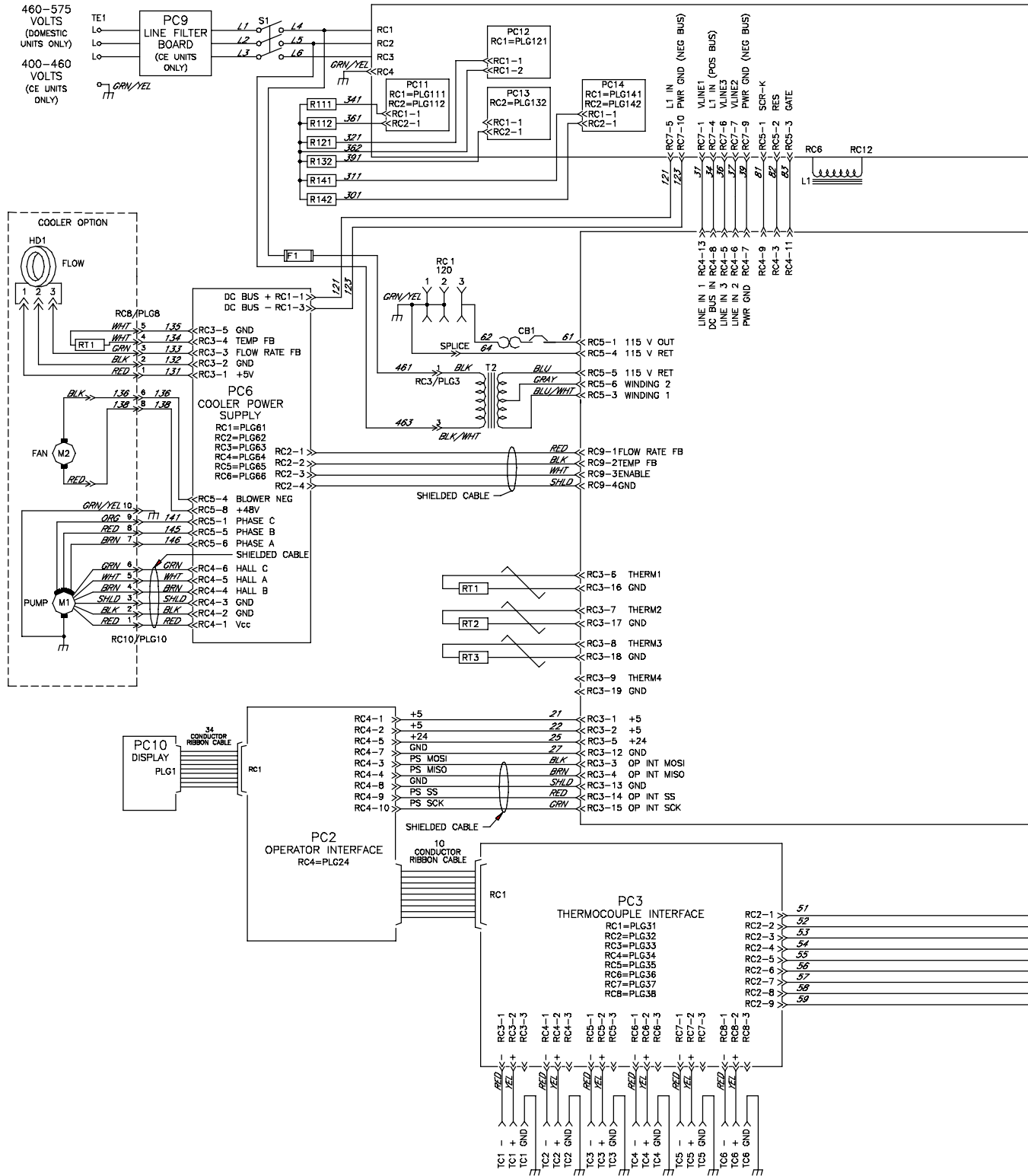
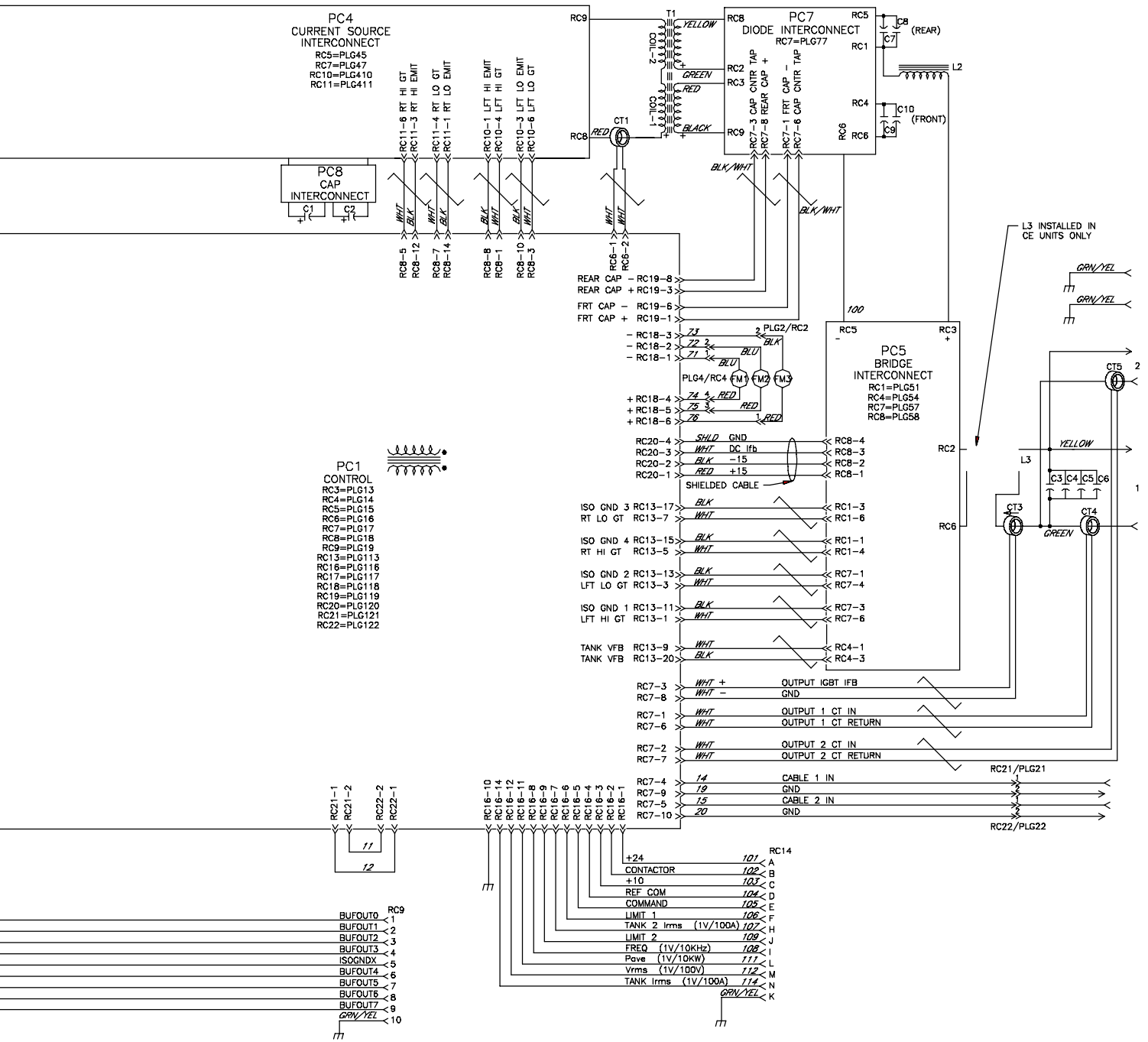

Figure 10-1. Circuit Diagram



SECTION 11 – PARTS LIST

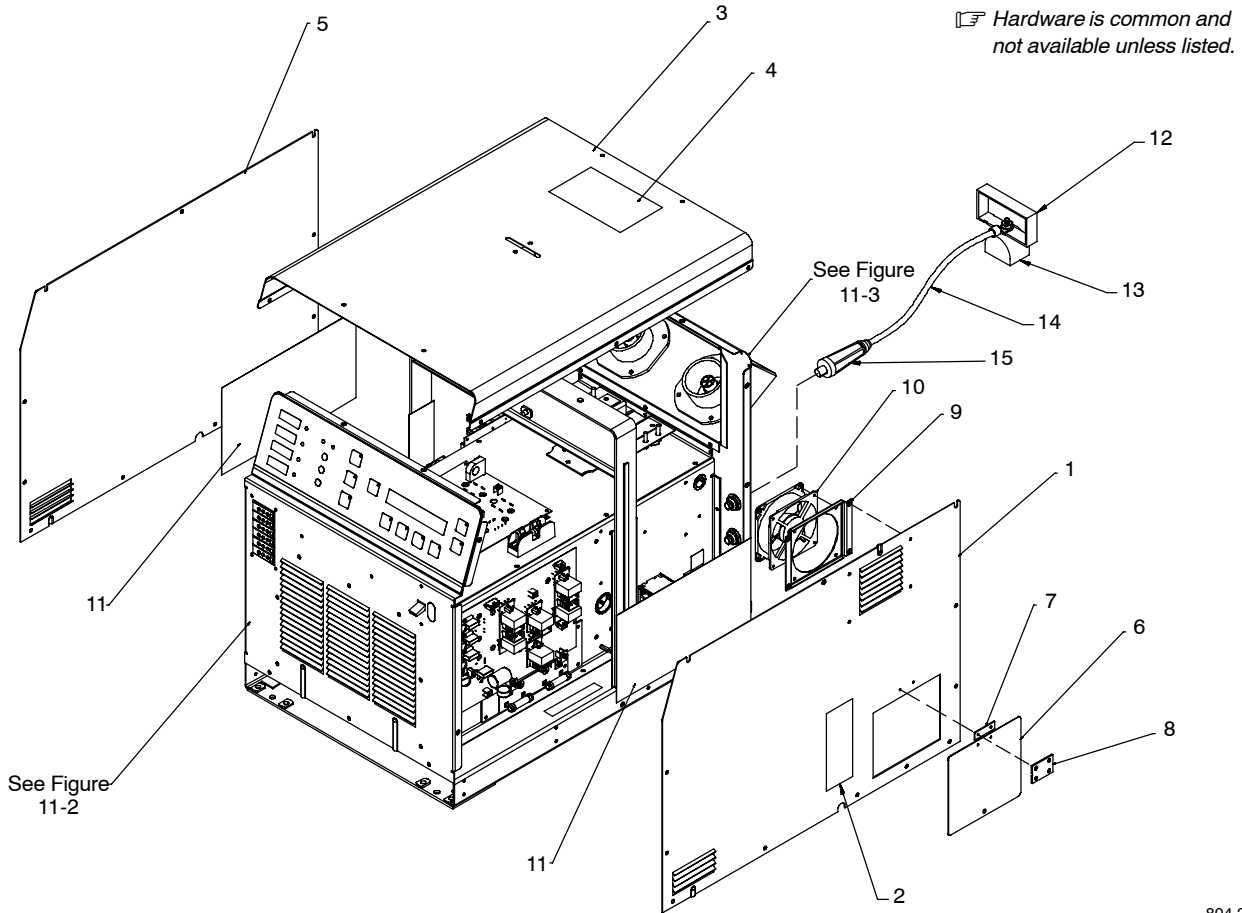

Figure 11-1. Wrappers

804 218-D

Item No.	Dia. Mkgs.	Part No.	Description	Quantity
...	Figure 11-1. Wrappers	...
...	...	+217 470 ..	PANEL, side RH	1
...	...	217 860 ..	LABEL, warning electric shock and input pwr (FR)	1
...	...	+217 325 ..	COVER, top	1
...	...	147 876 ..	LABEL, warning general precautionary induction heat	1
...	...	217 334 ..	PANEL, side LH	1
...	...	217 468 ..	DOOR, primary board	1
...	...	189 491 ..	SPACER, hinge	1
...	...	168 343 ..	HINGE, cont polyolefin copolymer	1
...	...	222 106 ..	BRACKET, mtg fan	1
...	FM3	236 263 ..	FAN, muffin 24VDC 3000 RPM 130 CFM	1
...	...	206 270 ..	INSULATOR, side RH	2
...	...	198 035 ..	HANDLE	1
...	...	197 931 ..	MAGNET, permanent	1
...	...	197 900 ..	CABLE, work ground	1
...	...	127 836 ..	PLUG, tw lk insul male	1
...	RC2	135 635 ..	HOUSING PLUG+PINS,(SERVICE KIT)	1
...	PLG2	131 054 ..	HOUSING RCPT+SKTS,(SERVICE KIT)	1
...	PLG61	131 204 ..	HOUSING PLUG+SKTS,(SERVICE KIT)	1
...	PLG63	115 094 ..	HOUSING PLUG+SKTS,(SERVICE KIT)	1

+When ordering a component originally displaying a precautionary label, the label should also be ordered.

*Recommended Spare Parts.

To maintain the factory original performance of your equipment, use only Manufacturer's Suggested Replacement Parts. Model and serial number required when ordering parts from your local distributor.

☞ Hardware is common and not available unless listed.

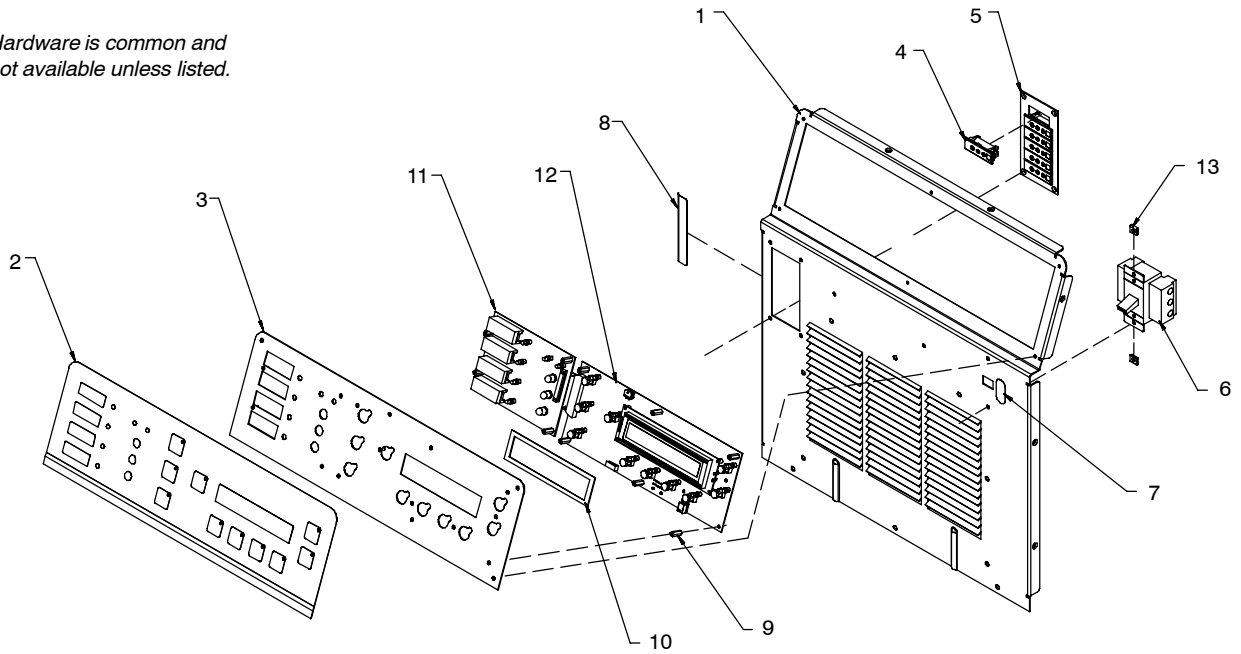

804 219-A

Figure 11-2. Front Panel

Item No.	Dia. Mkgs.	Part No.	Description	Quantity
Figure 11-2. Front Panel				
1		217 323	PANEL, front	1
2		216 225	NAMEPLATE, ProHeat 35	1
3		216 224	PANEL, operator interface	1
4	TC1-TC6	218 686	RECEPTACLE ASSY, thermocouple	6
5		217 327	PLATE, TC receptacle	1
6	S1	213 060	SWITCH, tgl 3pst 60 A 600 VAC	1
7		212 810	LABEL, on-off w/symbols	1
8		221 493	LABEL, TC 1-6	1
9		115 440	STANDOFF, no 6-32	14
10		224 143	GASKET, meter lens	1
11	PC8	216 068	CIRCUIT CARD ASSY, display	1
12	PC2	216 072	CIRCUIT CARD ASSY, operator interface	1
13		148 297	NUT, 006-32 .31 hex .20 stl pld	2
	PLG24	115 091	HOUSING PLUG+SKTS,(SERVICE KIT)	1

*Recommended Spare Parts.

To maintain the factory original performance of your equipment, use only Manufacturer's Suggested Replacement Parts. Model and serial number required when ordering parts from your local distributor.

☞ Hardware is common and not available unless listed.

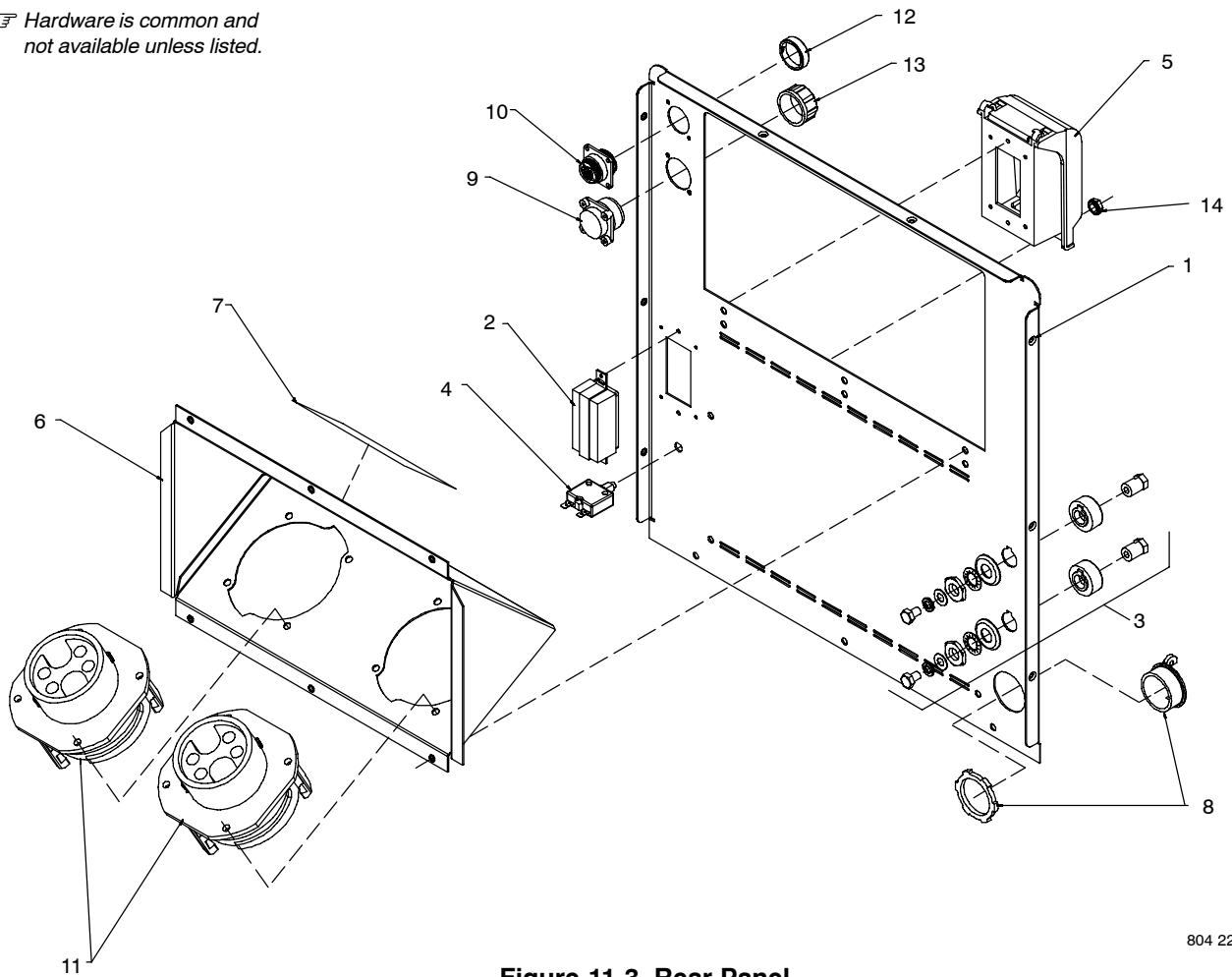

804 220-A

Figure 11-3. Rear Panel

Item No.	Dia. Mkgs.	Part No.	Description	Quantity
----------	------------	----------	-------------	----------

Figure 11-3. Rear Panel

1		217 324	PANEL, rear	1
2	RC1	174 207	RECEPTACLE, str dx grd 2P 3W 15 A 125 V	1
3		127 837	RECEPTACLE, tw lk insul fem (dinse type)	2
4	CB1	089 807	SUPPLEMENTARY PROTECTOR, man reset 1P 2.5 A 250 VAC	1
5		220 824	COVER, receptacle weatherproof duplex	1
6		+218 689	PANEL, rear output	1
7		602 498	LABEL, danger high voltage	1
8		010 467	CONNECTOR, clamp cable 1.250	1
9	RC14	143 976	RCPT W/SKTS, (service kit)	1
10	RC9	047 636	HOUSING PLUG+PINS,(service kit)	1
11		224 989	RECEPTACLE ASSY, output (with leads)	2
		234 531	SHELL, w/contact pin and socket (service kit for 224 989)	0
12		224 042	CONNECTOR, circ CPC protective cap	1
13		170 391	CONNECTOR, circ MS protective cap	1
14		147 195	NUT, 375-27 .54 hex .25 H nyl	1
	RC21,22	135 635	HOUSING PLUG+PINS,(SERVICE KIT)	2
	PLG21,22	131 054	HOUSING RCPT+SKTS,(SERVICE KIT)	2

+When ordering a component originally displaying a precautionary label, the label should also be ordered.

*Recommended Spare Parts.

To maintain the factory original performance of your equipment, use only Manufacturer's Suggested Replacement Parts. Model and serial number required when ordering parts from your local distributor.

☞ Hardware is common and not available unless listed.

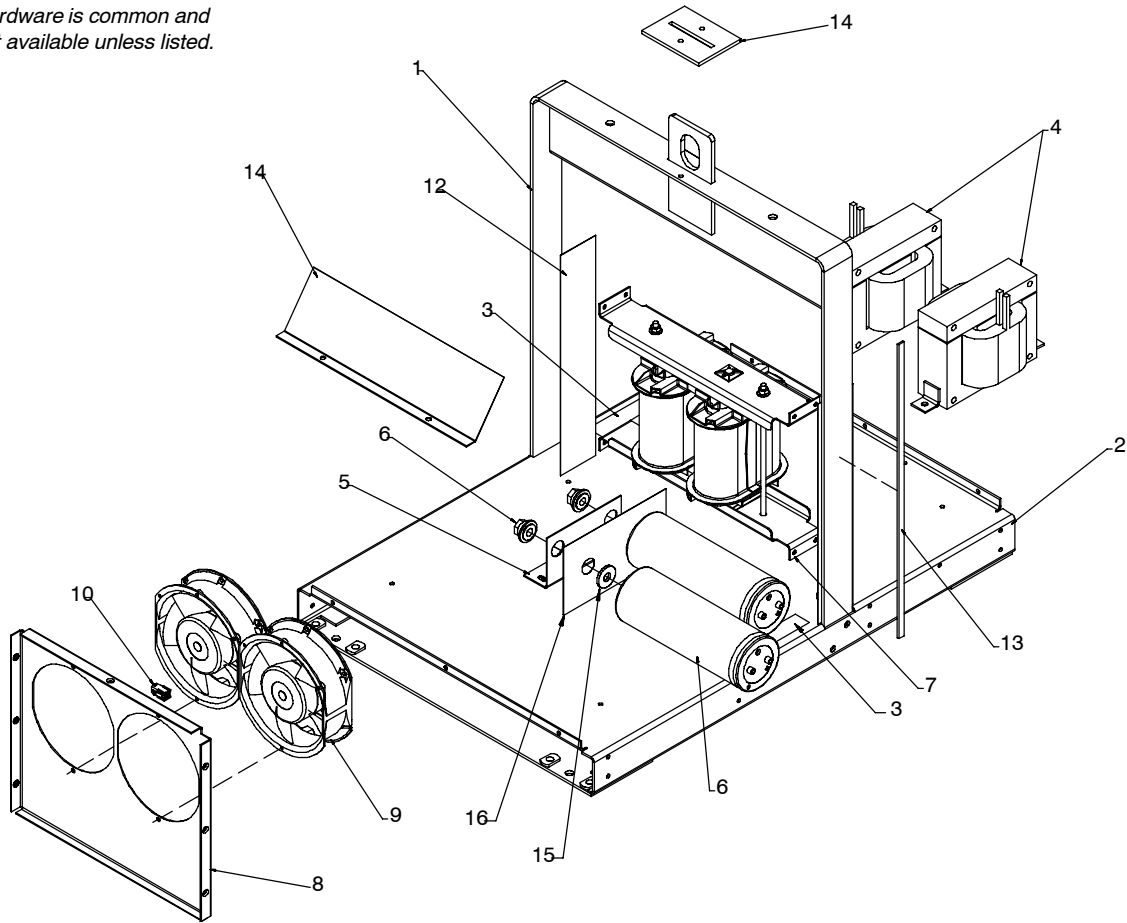

Figure 11-4. Base w/Components

804 221-D

Item No.	Dia. Mkgs.	Part No.	Description	Quantity
----------	------------	----------	-------------	----------

Figure 11-4. Base w/Components

...	1	217 328	.. FRAME, lifting	1
...	2	213 865	.. BASE ASSY	1
...	3	213 939	.. LABEL, warning electric shock can kill significant	2
...	4	L1,L2 218 692	.. INDUCTOR	2
...	5	216 815	.. BRACKET, cap support	1
...	6	C1,2 213 870	.. CAPACITOR, elctlt	2
...	7	T1 213 583	.. TRANSFORMER, hf	1
...	7	T1 227 065	.. TRANSFORMER, hf (400V model)	1
...	8	216 629	.. BRACKET, fan	1
...	9	FM1,FM2 222 728	.. FAN, nuffin 48 V	2
...	10	RC4 115 090	.. HOUSING PLUG+PINS, (service kit)	1
...	11	217 992	.. BAFFLE, air bottom	1
...	12	224 973	.. INSULATOR, lift frame	2
...	13	603 115	.. WEATHERSTRIPPING	2
...	14	026 627	.. GASKET, lifting eye cover	1
...	PLG4	115 094	.. HOUSING PLUG+SKTS,(SERVICE KIT)	1
...	15	226 837	.. WASHER, rubber .343 id x .875 od x .093 thk	2
...	16	226 838	.. INSULATOR, capacitor	1

*Recommended Spare Parts.

To maintain the factory original performance of your equipment, use only Manufacturer's Suggested Replacement Parts. Model and serial number required when ordering parts from your local distributor.

☞ Hardware is common and not available unless listed.

See Figure 11-6

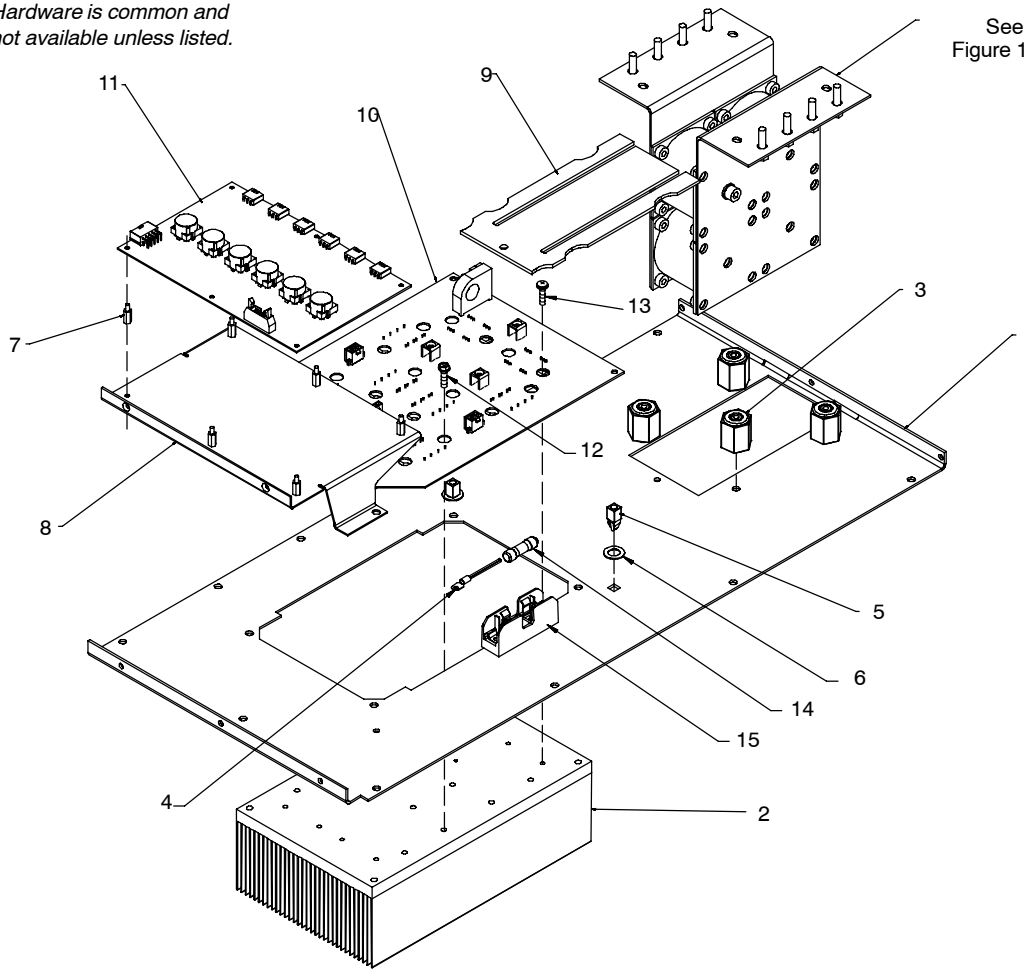

Figure 11-5. Top Windtunnel

804 222-A

Item No.	Dia. Mkgs.	Part No.	Description	Quantity
----------	------------	----------	-------------	----------

Figure 11-5. Top Windtunnel

...	1	218 424	WINDTUNNEL, top	1
...	2	218 684	HEAT SINK, AC commutator	1
...	3	025 248	STANDOFF, insul .250-20 x 1.250 lg x .437 thd	4
...	4	RT2	THERMISTOR, ntc 30 k ohm at 25 deg C 24 in lead	1
...	5	083 147	GROMMET, scr no 8/10 panel hole .312 sq .500 high	2
...	6	605 339	WASHER, TOOTH .377 ID X 0.507 OD X .022T stl pld	2
...	7	098 691	STAND-OFF,NO 6-32 X .500 LG .250 hex stl m&f	6
...	8	217 326	BRACKET, TC interface	1
...	9	218 691	INSULATOR, tank cap	1
...	10	PC5	KIT, circuit card assy intrcnct bridge	1
...	11	PC3	CIRCUIT CARD ASSY, TC interface	1
...	12	208 591	SCREW, M 5- .8X 12 soc hd-torx stl pld sems	12
...	13	212 038	SCREW, M4 - .7 x 8.5 pan hd-phl stl pld	8
...	14	F1	FUSE, crtg 2. amp 600 V time delay	1
...	15	225 553	HOLDER, fuse crtg 30 A 600 V 13/32 X 1-1/2 LG	1
...	PLG32	115 091	HOUSING PLUG+SKTS,(SERVICE KIT)	1
...	PLG33-38,54	131 204	HOUSING PLUG+SKTS,(SERVICE KIT)	7
...	PLG51,57	115 093	HOUSING PLUG+SKTS,(SERVICE KIT)	2
...	PLG58	115 094	HOUSING PLUG+SKTS,(SERVICE KIT)	1
...		227 082	CHOKE, common mode (400 V model only)	1

*Recommended Spare Parts.

To maintain the factory original performance of your equipment, use only Manufacturer's Suggested Replacement Parts. Model and serial number required when ordering parts from your local distributor.

☞ Hardware is common and not available unless listed.

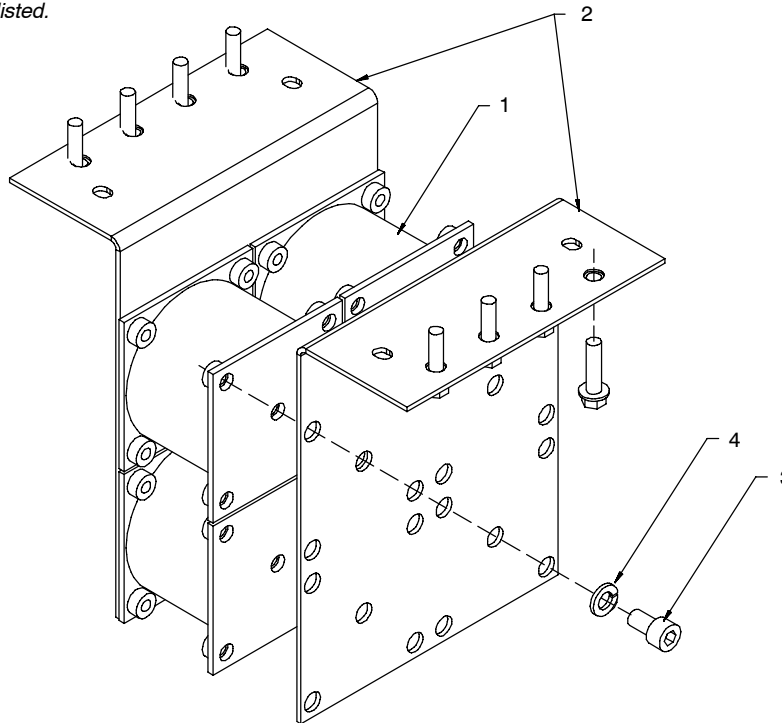

804 223-A

Figure 11-6. Capacitor Assembly

Item No.	Dia. Mkgs.	Part No.	Description	Quantity
Figure 11-6. Capacitor Assembly				
... 1 ..	C3-C6	218 685	CAPACITOR, popyp met film 1.5 uf 700 VAC	4
... 2 ..		218 688	BUS BAR, tank	2
... 3 ..		†221 419	SCREW, M8 -1.2 x 12 soc hd-zinc cls	40
... 4 ..		602 211	WASHER, lock .318 ID X 0.586 OD X .078T STL PLD SPLIT.312	40

*Recommended Spare Parts.

†Torque screws to 50 in lbs (5.6 N·m).

To maintain the factory original performance of your equipment, use only Manufacturer's Suggested Replacement Parts. Model and serial number required when ordering parts from your local distributor.

☞ Hardware is common and not available unless listed.

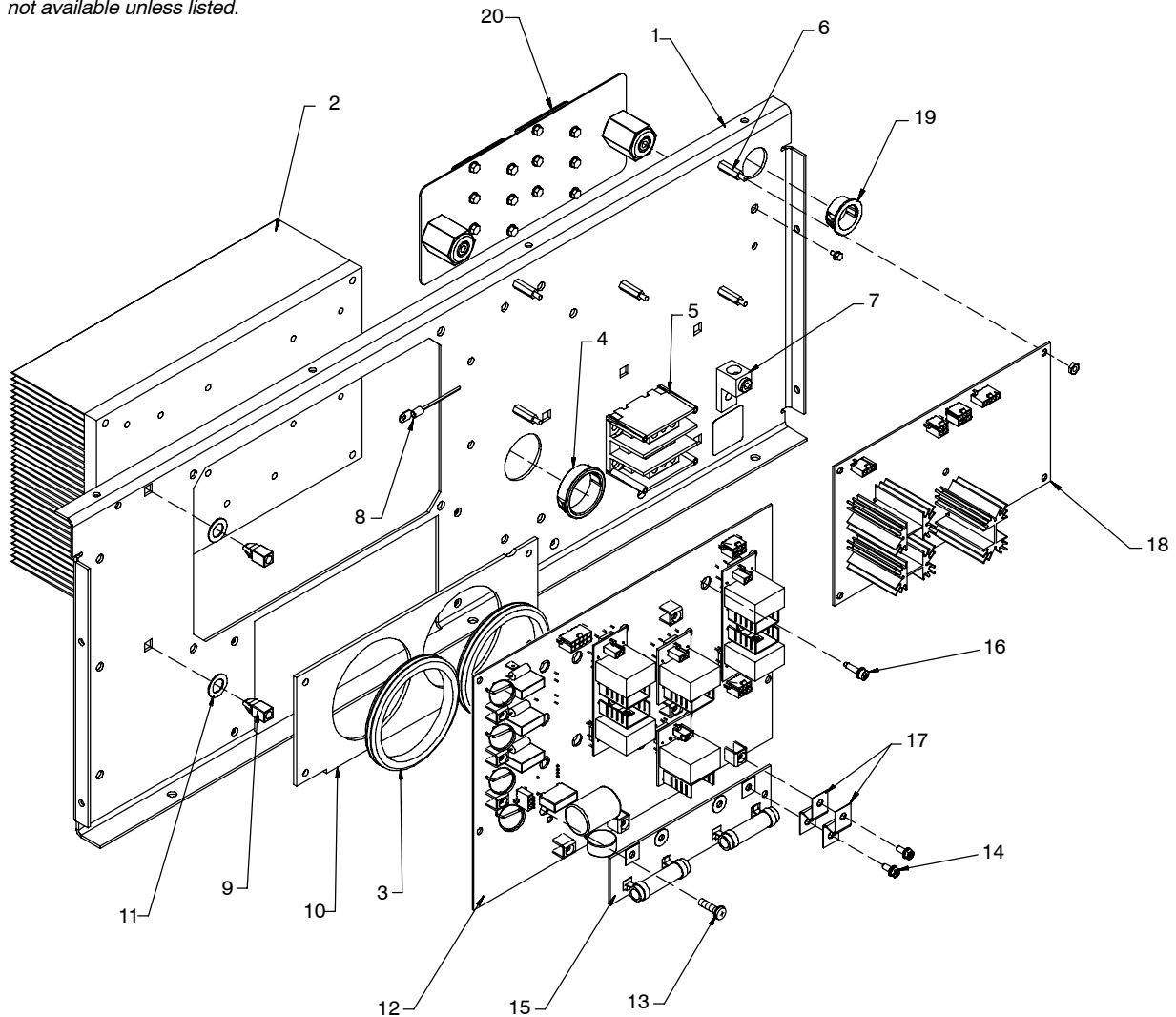

804 224-E

Figure 11-7. Right Windtunnel

Item No.	Dia. Mkgs.	Part No.	Description	Quantity
----------	------------	----------	-------------	----------

Figure 11-7. Right Windtunnel

...	1	216 630	.. WINDTUNNEL, RH	1
...	2	213 873	.. HEAT SINK, current source	1
...	3	213 871	.. GROMMET, rbr sil 3.000 ID x 3.250 mtg hole	2
...	4	170 647	.. BUSHING, snap-in nyl 1.312 ID x 1.500 mtg hole	1
...	5	223 120	.. BLOCK, term 115 amp 3 pole screw term	1
...	6	115 443	.. STAND-OFF, no 6-32 x .750 lg .250 hex	5
...	7	148 743	.. LUG, univ w/scr 600V 2-14 wire .250 stud	1
...	8	RT1	.. THERMISTOR, ntc 30 k ohm at 25 deg C 34 in lead	1
...	9	083 147	.. GROMMET, scr no 8/10 panel hole .312 sq .500 high	2
...	10	224 391	.. PANEL, insulating mtg capacitor	1
...	11	605 339	.. WASHER, TOOTH .377 ID X 0.507 OD X .022T stl pld	2
...	12	PC4	.. KIT, circuit card assy intrcnct I srce inpt	1
...	13	212 038	.. SCREW, M4 - .7 x 8.5 pan hd-phl stl pld	2
...	14	176 879	.. SCREW, M5 - .8 x 12 hex hd-phl 8.8 pld	12
...	15	228 262	.. CIRCUIT CARD ASSY, bus intrcnct	1
...	16	208 591	.. SCREW, M 5- .8X 12 soc hd-torx stl pld sems	14

Item No.	Dia. Mkgs.	Part No.	Description	Quantity
Figure 11-7. Right Windtunnel (Continued)				
... 17	229 728	.. STRAP, connecting	4
... 18	216 262	.. CIRCUIT CARD ASSY, cooler control	1
... 19	030 170	.. BUSHING, snap-in nyl .750 id x 1.000 mtg hole	1
... 20	231 050	.. ASSY, resistor	1
.....	PLG64,410,			
	411 115 093	.. HOUSING PLUG+SKTS, (SERVICE KIT)	3
.....	PLG47 115 091	.. HOUSING PLUG+SKTS, (SERVICE KIT)	1
.....	PLG45,61	.. 131 204	.. HOUSING PLUG+SKTS, (SERVICE KIT)	2
.....	PLG62	.. 201 665	.. HOUSING PLUG+SKTS, (SERVICE KIT)	1
.....	PLG63 115 094	.. HOUSING PLUG+SKTS, (SERVICE KIT)	1
.....	PLG111, 112			
	121, 132,			
	141, 142	... 131 054	.. HOUSING RCPT+SKTS, (SERVICE KIT)	6

*Recommended Spare Parts.

To maintain the factory original performance of your equipment, use only Manufacturer's Suggested Replacement Parts. Model and serial number required when ordering parts from your local distributor.

☞ Hardware is common and not available unless listed.

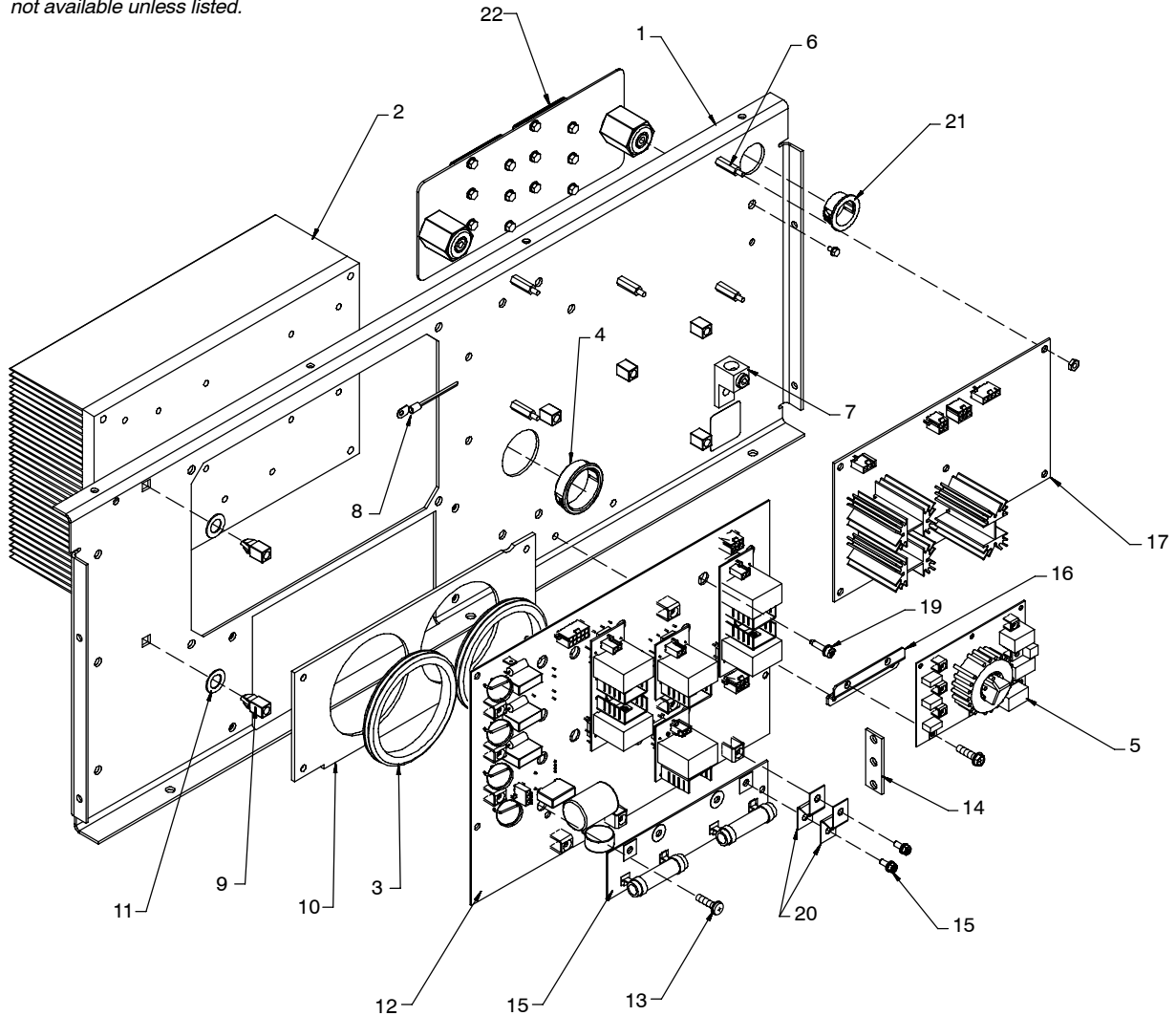

804 431-E

Figure 11-8. Right Windtunnel (400 V Model Only)

Item No.	Dia. Mkgs.	Part No.	Description	Quantity
----------	------------	----------	-------------	----------

Figure 11-8. Right Windtunnel (400 V Model Only)

1		216 630	WINDTUNNEL, RH	1
2		213 873	HEAT SINK, current source	1
3		213 871	GROMMET, rbr sil 3.000 ID x 3.250 mtg hole	2
4		170 647	BUSHING, snap-in nyl 1.312 ID x 1.500 mtg hole	1
5		225 356	CIRCUIT CARD ASSY, input filter	1
6		115 443	STAND-OFF, no 6-32 x .750 lg .250 hex	5
7		148 743	LUG, univ w/scr 600V 2-14 wire .250 stud	1
8	RT1	222 326	THERMISTOR, ntc 30 k ohm at 25 deg C 34 in lead	1
9		083 147	GROMMET, scr no 8/10 panel hole .312 sq .500 high	6
10		224 391	PANEL, insulating mtg capacitor	1
11		605 339	WASHER, TOOTH .377 ID X 0.507 OD X .022T stl pld	2
12	PC4	228 407	KIT, circuit card assy intrcnc t srce inpt	1
13		212 038	SCREW, M4 - .7 x 8.5 pan hd-phl stl pld	2
14		226 579	SPACER, leads	1
15		176 879	SCREW, M5 - .8 x 12 hex hd-phl 8.8 pld	12
16		226 041	BRACKET, mtg ce filter ground plane	1
17		216 262	CIRCUIT CARD ASSY, cooler control	1
18		228 262	CIRCUIT CARD ASSY, bus intrcnc t	1

Item No.	Dia. Mkgs.	Part No.	Description	Quantity
----------	------------	----------	-------------	----------

Figure 11-8. Right Windtunnel (400 V Model Only) (Continued)

... 19	208 591	.. SCREW, M 5- .8X 12 soc hd-torx stl pld sems	14
... 20	229 728	.. STRAP, connecting	4
... 21	030 170	.. BUSHING, snap-in nyl .750 id x 1.000 mtg hole	1
... 22	231 050	.. ASSY, resistor	1
.....	PLG64,410,			
	411 115 093	.. HOUSING PLUG+SKTS, (SERVICE KIT)	3
.....	PLG47 115 091	.. HOUSING PLUG+SKTS, (SERVICE KIT)	1
.....	PLG45,61	.. 131 204	.. HOUSING PLUG+SKTS, (SERVICE KIT)	2
.....	PLG62	... 201 665	.. HOUSING PLUG+SKTS, (SERVICE KIT)	1
.....	PLG63 115 094	.. HOUSING PLUG+SKTS, (SERVICE KIT)	1
.....	PLG111, 112			
	121, 132,			
	141, 142	... 131 054	.. HOUSING RCPT+SKTS, (SERVICE KIT)	6

*Recommended Spare Parts.

To maintain the factory original performance of your equipment, use only Manufacturer's Suggested Replacement Parts. Model and serial number required when ordering parts from your local distributor.

☞ Hardware is common and not available unless listed.

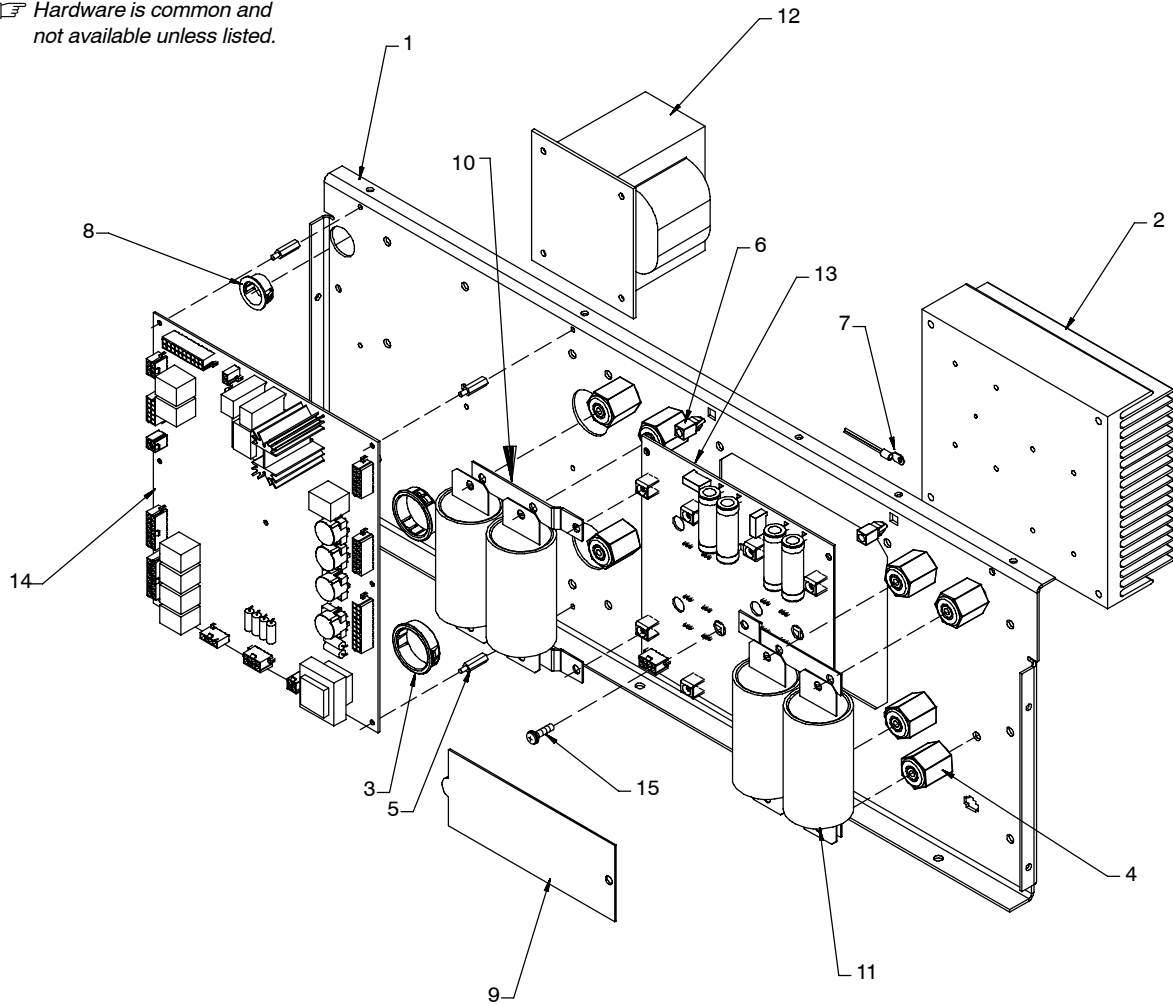

804 225-A

Figure 11-9. Left Windtunnel

Item No.	Dia. Mkgs.	Part No.	Description	Quantity
----------	------------	----------	-------------	----------

Figure 11-9. Left Windtunnel

...	1	216 631	.. WINDTUNNEL, LH	1
...	2	218 683	.. HEAT SINK, diode	1
...	3	170 647	.. BUSHING, snap-in nyl 1.312 ID x 1.500 mtg hole	2
...	4	025 248	.. STAND-OFF, insul .250-20 x 1.250 lg x .437 thd	8
...	5	115 443	.. STAND-OFF, no 6-32 x .750 lg .250 hex	7
...	6	083 147	.. GROMMET, scr no 8/10 panel hole .312 sq .500 high	2
...	7	RT3 222 327	.. THERMISTOR, ntc 30 k ohm at 25 deg C 24 in lead	1
...	8	030 170	.. BUSHING, snap-in nyl .750 ID x 1.000 mtg hole	1
...	9	218 430	.. COVER, access	1
...	10	220 825	.. BUS BAR, capacitor	4
...	11	C7-C10 218 687	.. CAPACITOR, polyp film 1.35 uf 700 VAC +5% -0%	4
...	11	C7-C10 225 775	.. CAPACITOR, polyp film 1.10 uf 700 vac +5% -0% (400 V model only)	4
...	12	T2 219 002	.. TRANSFORMER, control	1
...	13	PC7 225 558	.. KIT, circuit card assy intrcnct l srce out	1
...	14	PC1 217 928	.. CIRCUIT CARD ASSY, power source control	1
...	15	212 038	.. SCREW, M4 - .7 x 8.5 pan hd-phl stl pld slffmg	8

Item No.	Dia. Mkgs.	Part No.	Description	Quantity
Figure 11-9. Left Windtunnel (Continued)				
.....	PLG16, 121,122	... 131 054 ..	HOUSING RCPT+SKTS,(SERVICE KIT)	3
.....	PLG19, 120 115 094 ..	HOUSING PLUG+SKTS,(SERVICE KIT)	2
.....	PLG15, 118 115 093 ..	HOUSING PLUG+SKTS,(SERVICE KIT)	2
.....	PLG77, 119 115 092 ..	HOUSING PLUG+SKTS,(SERVICE KIT)	2
.....	PLG17 115 091 ..	HOUSING PLUG+SKTS,(SERVICE KIT)	1
.....	PLG18, 116 131 056 ..	HOUSING RCPT+SKTS,(SERVICE KIT)	2
.....	PLG13, 113 162 382 ..	HOUSING PLUG+SKTS,(SERVICE KIT)	2
.....	PLG14	... 130 203 ..	HOUSING PLUG+SKTS,(SERVICE KIT)	1

*Recommended Spare Parts.

To maintain the factory original performance of your equipment, use only Manufacturer's Suggested Replacement Parts. Model and serial number required when ordering parts from your local distributor.

☞ Hardware is common and not available unless listed.

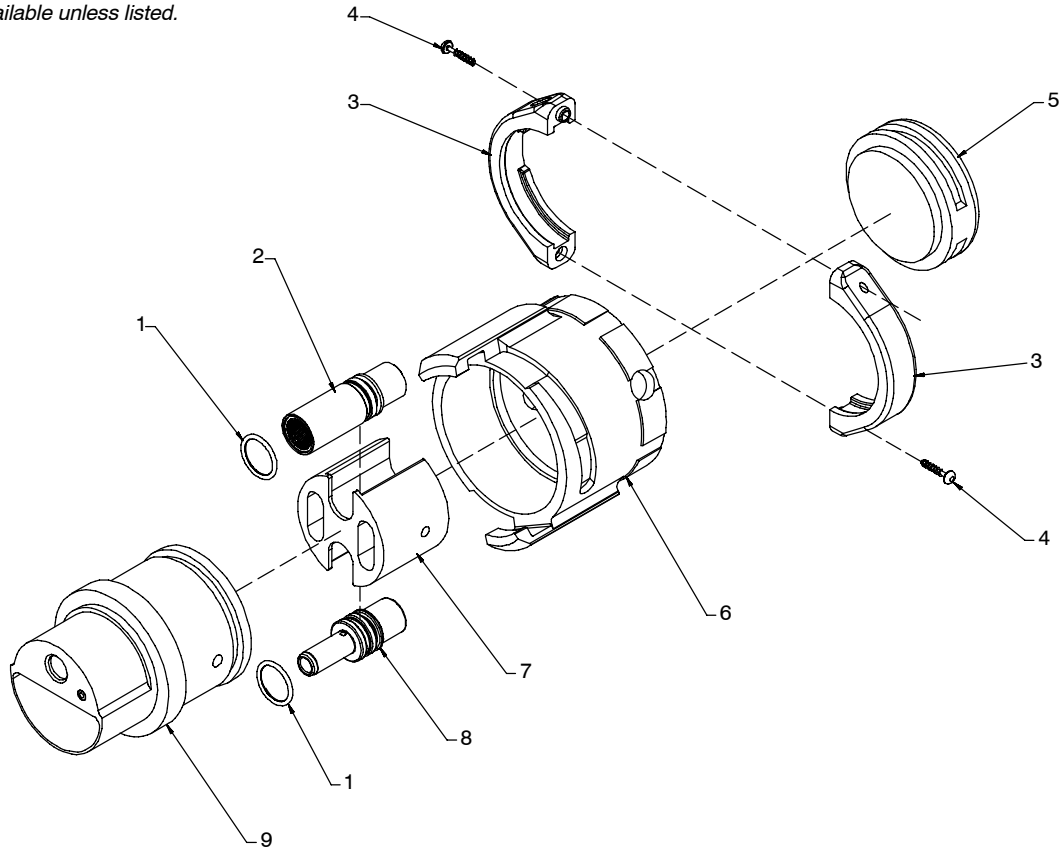

804 300-A

Figure 11-10. Hermaphroditic Blank Plug Assy

Item No.	Dia. Mkgs.	Part No.	Description	Quantity
Figure 11-10. Hermaphroditic Blank Plug Assy				
...	1	221 440	O-RING, .737 ID x .103 CS	2
...	2	221 443	SOCKET ASSY, radsok 14 mm cable end	1
...	3	221 099	CLAMP, strain relief	2
...	4	136 343	SCREW, K50 x 20 pan hd-phl stl pld pt	2
...	5	224 261	CAP, plug assy	1
...	6	221 438	COLLAR, coupling	1
...	7	221 437	RETAINER, contact	1
...	8	221 442	PIN, radsok 14 mm cable end	1
...	9	225 919	SHELL ASSY, connector - protective plug	1

Notes

**SOCKET/WRENCH SELECTION TABLE
(U.S. STANDARD)**

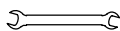

**SOCKET/WRENCH SELECTION TABLE
(METRIC)**

Specifications		Socket or Wrench Size		Specifications		Socket or Wrench Size	
Bolt Diameter	Decimal Equivalent	Bolt	Nut	Bolt Diameter	U.S. Decimal Equivalent	Bolt	Nut
1/4 in	.250 in	3/8 in	7/16 in	6 mm	.2362 in	10 mm	10 mm
5/16 in	.3125 in	1/2 in	9/16 in	8 mm	.3150 in	14 mm	14 mm
3/8 in	.375 in	9/16 in	5/8 in	10 mm	.3937 in	17 mm	17 mm
7/16 in	.4375 in	5/8 in	3/4 in	12 mm	.4724 in	19 mm	19 mm
1/2 in	.500 in	3/4 in	13/16 in	14 mm	.5512 in	22 mm	22 mm
9/16 in	.5625 in	7/8 in	7/8 in	16 mm	.6299 in	24 mm	24 mm
5/8 in	.625 in	15/16 in	1 in	18 mm	.7087 in	27 mm	27 mm
3/4 in	.750 in	1-1/8 in	1-1/8 in	22 mm	.8661 in	32 mm	32 mm
7/8 in	.875 in	1-5/16 in	1-5/16 in	24 mm	.9449 in	36 mm	36 mm
1 in	1.000 in	1-1/2 in	1-1/2 in				

Notes

DECIMAL EQUIVALENTS

	$\frac{1}{64}$.015625
	$\frac{2}{64}$.03125
	$\frac{3}{64}$.046875
$\frac{1}{16}$	$\frac{4}{64}$.0625
	$\frac{5}{64}$.078125
	$\frac{6}{64}$.09375
	$\frac{7}{64}$.109375
$\frac{1}{8}$	$\frac{8}{64}$.125
	$\frac{9}{64}$.140625
	$\frac{10}{64}$.15625
	$\frac{11}{64}$.171875
$\frac{3}{16}$	$\frac{12}{64}$.1875
	$\frac{13}{64}$.203125
	$\frac{14}{64}$.21875
	$\frac{15}{64}$.234375
$\frac{1}{4}$	$\frac{16}{64}$.25
	$\frac{17}{64}$.265625
	$\frac{18}{64}$.28125
	$\frac{19}{64}$.296875
$\frac{5}{16}$	$\frac{20}{64}$.3125
	$\frac{21}{64}$.328125
	$\frac{22}{64}$.34375
	$\frac{23}{64}$.359375
$\frac{3}{8}$	$\frac{24}{64}$.375
	$\frac{25}{64}$.390625
	$\frac{26}{64}$.40625
	$\frac{27}{64}$.421875
$\frac{7}{16}$	$\frac{28}{64}$.4375
	$\frac{29}{64}$.453125
	$\frac{30}{64}$.46875
	$\frac{31}{64}$.484375
$\frac{1}{2}$	$\frac{32}{64}$.5
	$\frac{33}{64}$.515625
	$\frac{34}{64}$.53125
	$\frac{35}{64}$.546875
$\frac{9}{16}$	$\frac{36}{64}$.5625
	$\frac{37}{64}$.578125
	$\frac{38}{64}$.59375
	$\frac{39}{64}$.609375
$\frac{5}{8}$	$\frac{40}{64}$.625
	$\frac{41}{64}$.640625
	$\frac{42}{64}$.65625
	$\frac{43}{64}$.671875
$\frac{11}{16}$	$\frac{44}{64}$.6875
	$\frac{45}{64}$.703125
	$\frac{46}{64}$.71875
	$\frac{47}{64}$.734375
$\frac{3}{4}$	$\frac{48}{64}$.75
	$\frac{49}{64}$.765625
	$\frac{50}{64}$.78125
	$\frac{51}{64}$.796875
$\frac{13}{16}$	$\frac{52}{64}$.8125
	$\frac{53}{64}$.828125
	$\frac{54}{64}$.84375
	$\frac{55}{64}$.859375
$\frac{7}{8}$	$\frac{56}{64}$.875
	$\frac{57}{64}$.890625
	$\frac{58}{64}$.90625
	$\frac{59}{64}$.921875
$\frac{15}{16}$	$\frac{60}{64}$.9375
	$\frac{61}{64}$.953125
	$\frac{62}{64}$.96875
	$\frac{63}{64}$.984375
1	$\frac{64}{64}$	1.

TRUE BLUE® WARRANTY

Effective January 1, 2007

(Equipment with a serial number preface of "LH" or newer)

This limited warranty supersedes all previous Miller warranties and is exclusive with no other guarantees or warranties expressed or implied.

LIMITED WARRANTY – Subject to the terms and conditions below, Miller Electric Mfg. Co., Appleton, Wisconsin, warrants to its original retail purchaser that new Miller equipment sold after the effective date of this limited warranty is free of defects in material and workmanship at the time it is shipped by Miller. THIS WARRANTY IS EXPRESSLY IN LIEU OF ALL OTHER WARRANTIES, EXPRESS OR IMPLIED, INCLUDING THE WARRANTIES OF MERCHANTABILITY AND FITNESS.

Within the warranty periods listed below, Miller will repair or replace any warranted parts or components that fail due to such defects in material or workmanship. Miller must be notified in writing within thirty (30) days of such defect or failure, at which time Miller will provide instructions on the warranty claim procedures to be followed.

Miller shall honor warranty claims on warranted equipment listed below in the event of such a failure within the warranty time periods. All warranty time periods start on the delivery date of the equipment to the original end-user purchaser, and not to exceed one year after the equipment is shipped to a North American distributor or eighteen months after the equipment is shipped to an International distributor.

- 5 Years Parts — 3 Years Labor
 - * Original main power rectifiers
- 3 Years — Parts and Labor
 - * Transformer/Rectifier Power Sources
 - * Plasma Arc Cutting Power Sources
 - * Process Controllers
 - * Semi-Automatic and Automatic Wire Feeders
 - * Inverter Power Sources (Unless Otherwise Stated)
 - * Water Coolant Systems (Integrated)
 - * Intellitig
 - * Engine Driven Welding Generators
(NOTE: Engines are warranted separately by the engine manufacturer.)
- 1 Year — Parts and Labor Unless Specified
 - * Motor Driven Guns (w/exception of Spoolmate Spoolguns)
 - * Positioners and Controllers
 - * Automatic Motion Devices
 - * RFCS Foot Controls
 - * Induction Heating Power Sources, Coolers, and Electronic Controls/Recorders
 - * Water Coolant Systems (Non-Integrated)
 - * Flowgauge and Flowmeter Regulators (No Labor)
 - * HF Units
 - * Grids
 - * Spot Welders
 - * Load Banks
 - * Arc Stud Power Sources & Arc Stud Guns
 - * Racks
 - * Running Gear/Trailers
 - * Plasma Cutting Torches (except APT & SAF Models)
 - * Field Options
(NOTE: Field options are covered under True Blue® for the remaining warranty period of the product they are installed in, or for a minimum of one year — whichever is greater.)
 - * Bernard-Branded Mig Guns (No Labor)
 - * Weldcraft-Branded TIG Torches (No Labor)
 - * Subarc Wire Drive Assemblies
- 6 Months — Batteries
- 90 Days — Parts
 - * MIG Guns/TIG Torches and Subarc (SAW) Guns

- * Induction Heating Coils and Blankets, Cables, and Non-Electronic Controls
- * APT & SAF Model Plasma Cutting Torches
- * Remote Controls
- * Accessory (Kits)
- * Replacement Parts (No labor)
- * Spoolmate Spoolguns
- * Canvas Covers

Miller's True Blue® Limited Warranty shall not apply to:

- Consumable components; such as contact tips, cutting nozzles, contactors, brushes, slip rings, relays or parts that fail due to normal wear. (Exception: brushes, slip rings, and relays are covered on Bobcat, Trailblazer, and Legend models.)**
- Items furnished by Miller, but manufactured by others, such as engines or trade accessories. These items are covered by the manufacturer's warranty, if any.
- Equipment that has been modified by any party other than Miller, or equipment that has been improperly installed, improperly operated or misused based upon industry standards, or equipment which has not had reasonable and necessary maintenance, or equipment which has been used for operation outside of the specifications for the equipment.

MILLER PRODUCTS ARE INTENDED FOR PURCHASE AND USE BY COMMERCIAL/INDUSTRIAL USERS AND PERSONS TRAINED AND EXPERIENCED IN THE USE AND MAINTENANCE OF WELDING EQUIPMENT.

In the event of a warranty claim covered by this warranty, the exclusive remedies shall be, at Miller's option: (1) repair; or (2) replacement; or, where authorized in writing by Miller in appropriate cases, (3) the reasonable cost of repair or replacement at an authorized Miller service station; or (4) payment of or credit for the purchase price (less reasonable depreciation based upon actual use) upon return of the goods at customer's risk and expense. Miller's option of repair or replacement will be F.O.B., Factory at Appleton, Wisconsin, or F.O.B. at a Miller authorized service facility as determined by Miller. Therefore no compensation or reimbursement for transportation costs of any kind will be allowed.

TO THE EXTENT PERMITTED BY LAW, THE REMEDIES PROVIDED HEREIN ARE THE SOLE AND EXCLUSIVE REMEDIES. IN NO EVENT SHALL MILLER BE LIABLE FOR DIRECT, INDIRECT, SPECIAL, INCIDENTAL OR CONSEQUENTIAL DAMAGES (INCLUDING LOSS OF PROFIT), WHETHER BASED ON CONTRACT, TORT OR ANY OTHER LEGAL THEORY.

ANY EXPRESS WARRANTY NOT PROVIDED HEREIN AND ANY IMPLIED WARRANTY, GUARANTY OR REPRESENTATION AS TO PERFORMANCE, AND ANY REMEDY FOR BREACH OF CONTRACT TORT OR ANY OTHER LEGAL THEORY WHICH, BUT FOR THIS PROVISION, MIGHT ARISE BY IMPLICATION, OPERATION OF LAW, CUSTOM OF TRADE OR COURSE OF DEALING, INCLUDING ANY IMPLIED WARRANTY OF MERCHANTABILITY OR FITNESS FOR PARTICULAR PURPOSE, WITH RESPECT TO ANY AND ALL EQUIPMENT FURNISHED BY MILLER IS EXCLUDED AND DISCLAIMED BY MILLER.

Some states in the U.S.A. do not allow limitations of how long an implied warranty lasts, or the exclusion of incidental, indirect, special or consequential damages, so the above limitation or exclusion may not apply to you. This warranty provides specific legal rights, and other rights may be available, but may vary from state to state.

In Canada, legislation in some provinces provides for certain additional warranties or remedies other than as stated herein, and to the extent that they may not be waived, the limitations and exclusions set out above may not apply. This Limited Warranty provides specific legal rights, and other rights may be available, but may vary from province to province.

miller_warr 2007-01

Warranty Questions?

Call
1-800-4-A-MILLER
for your local
Miller distributor.

Your distributor also gives
you ...

Service

You always get the fast,
reliable response you
need. Most replacement
parts can be in your
hands in 24 hours.

Support

Need fast answers to the
tough welding questions?
Contact your distributor.
The expertise of the
distributor and Miller is
there to help you, every
step of the way.





Owner's Record

Please complete and retain with your personal records.

Model Name

Serial/Style Number

Purchase Date

(Date which equipment was delivered to original customer.)

Distributor

Address

City

State

Zip



For Service

Contact a DISTRIBUTOR or SERVICE AGENCY near you.

Always provide Model Name and Serial/Style Number.

Contact your Distributor for:

Welding Supplies and Consumables

Options and Accessories

Personal Safety Equipment

Service and Repair

Replacement Parts

Training (Schools, Videos, Books)

Technical Manuals (Servicing Information and Parts)

Circuit Diagrams

Welding Process Handbooks

To locate a Distributor or Service Agency visit www.millerwelds.com or call 1-800-4-A-Miller

Contact the Delivering Carrier to:

File a claim for loss or damage during shipment.

For assistance in filing or settling claims, contact your distributor and/or equipment manufacturer's Transportation Department.

Miller Electric Mfg. Co.

An Illinois Tool Works Company
1635 West Spencer Street
Appleton, WI 54914 USA

International Headquarters—USA

USA Phone: 920-735-4505 Auto-Attended
USA & Canada FAX: 920-735-4134
International FAX: 920-735-4125

European Headquarters – United Kingdom

Phone: 44 (0) 1204-593493
FAX: 44 (0) 1204-598066

www.MillerWelds.com

