

IDEALARC® AC-1200

Single Phase Variable Voltage Power Source For Automatic AC Welding

For use with machines having Code Numbers 10291C, 10292C, 10465 and 10466.

Safety Depends on You

Lincoln arc welding and cutting equipment is designed and built with safety in mind. However, your overall safety can be increased by proper installation ... and thoughtful operation on your part. **DO NOT INSTALL, OPERATE OR REPAIR THIS EQUIPMENT WITHOUT READING THIS MANUAL AND THE SAFETY PRECAUTIONS CONTAINED THROUGHOUT.** And, most importantly, think before you act and be careful.



OPERATOR'S MANUAL



LINCOLN[®]
ELECTRIC

Copyright © Lincoln Global Inc.

• World's Leader in Welding and Cutting Products •

• Sales and Service through Subsidiaries and Distributors Worldwide •

Cleveland, Ohio 44117-1199 U.S.A. TEL: 216.481.8100 FAX: 216.486.1751 WEB SITE: www.lincolnelectric.com

⚠ WARNING

⚠ CALIFORNIA PROPOSITION 65 WARNINGS ⚠

Diesel engine exhaust and some of its constituents are known to the State of California to cause cancer, birth defects, and other reproductive harm.

The Above For Diesel Engines

The engine exhaust from this product contains chemicals known to the State of California to cause cancer, birth defects, or other reproductive harm.

The Above For Gasoline Engines

ARC WELDING CAN BE HAZARDOUS. PROTECT YOURSELF AND OTHERS FROM POSSIBLE SERIOUS INJURY OR DEATH. KEEP CHILDREN AWAY. PACEMAKER WEARERS SHOULD CONSULT WITH THEIR DOCTOR BEFORE OPERATING.

Read and understand the following safety highlights. For additional safety information, it is strongly recommended that you purchase a copy of "Safety in Welding & Cutting - ANSI Standard Z49.1" from the American Welding Society, P.O. Box 351040, Miami, Florida 33135 or CSA Standard W117.2-1974. A Free copy of "Arc Welding Safety" booklet E205 is available from the Lincoln Electric Company, 22801 St. Clair Avenue, Cleveland, Ohio 44117-1199.

BE SURE THAT ALL INSTALLATION, OPERATION, MAINTENANCE AND REPAIR PROCEDURES ARE PERFORMED ONLY BY QUALIFIED INDIVIDUALS.



FOR ENGINE powered equipment.

1.a. Turn the engine off before troubleshooting and maintenance work unless the maintenance work requires it to be running.



1.b. Operate engines in open, well-ventilated areas or vent the engine exhaust fumes outdoors.



1.c. Do not add the fuel near an open flame welding arc or when the engine is running. Stop the engine and allow it to cool before refueling to prevent spilled fuel from vaporizing on contact with hot engine parts and igniting. Do not spill fuel when filling tank. If fuel is spilled, wipe it up and do not start engine until fumes have been eliminated.

1.d. Keep all equipment safety guards, covers and devices in position and in good repair. Keep hands, hair, clothing and tools away from V-belts, gears, fans and all other moving parts when starting, operating or repairing equipment.

1.e. In some cases it may be necessary to remove safety guards to perform required maintenance. Remove guards only when necessary and replace them when the maintenance requiring their removal is complete. Always use the greatest care when working near moving parts.



1.f. Do not put your hands near the engine fan. Do not attempt to override the governor or idler by pushing on the throttle control rods while the engine is running.

1.g. To prevent accidentally starting gasoline engines while turning the engine or welding generator during maintenance work, disconnect the spark plug wires, distributor cap or magneto wire as appropriate.



1.h. To avoid scalding, do not remove the radiator pressure cap when the engine is hot.



ELECTRIC AND MAGNETIC FIELDS may be dangerous

2.a. Electric current flowing through any conductor causes localized Electric and Magnetic Fields (EMF). Welding current creates EMF fields around welding cables and welding machines

2.b. EMF fields may interfere with some pacemakers, and welders having a pacemaker should consult their physician before welding.

2.c. Exposure to EMF fields in welding may have other health effects which are now not known.

2.d. All welders should use the following procedures in order to minimize exposure to EMF fields from the welding circuit:

2.d.1. Route the electrode and work cables together - Secure them with tape when possible.

2.d.2. Never coil the electrode lead around your body.

2.d.3. Do not place your body between the electrode and work cables. If the electrode cable is on your right side, the work cable should also be on your right side.

2.d.4. Connect the work cable to the workpiece as close as possible to the area being welded.

2.d.5. Do not work next to welding power source.



ELECTRIC SHOCK can kill.

3.a. The electrode and work (or ground) circuits are electrically “hot” when the welder is on. Do not touch these “hot” parts with your bare skin or wet clothing. Wear dry, hole-free gloves to insulate hands.

3.b. Insulate yourself from work and ground using dry insulation. Make certain the insulation is large enough to cover your full area of physical contact with work and ground.

In addition to the normal safety precautions, if welding must be performed under electrically hazardous conditions (in damp locations or while wearing wet clothing; on metal structures such as floors, gratings or scaffolds; when in cramped positions such as sitting, kneeling or lying, if there is a high risk of unavoidable or accidental contact with the workpiece or ground) use the following equipment:

- **Semiautomatic DC Constant Voltage (Wire) Welder.**
- **DC Manual (Stick) Welder.**
- **AC Welder with Reduced Voltage Control.**

3.c. In semiautomatic or automatic wire welding, the electrode, electrode reel, welding head, nozzle or semiautomatic welding gun are also electrically “hot”.

3.d. Always be sure the work cable makes a good electrical connection with the metal being welded. The connection should be as close as possible to the area being welded.

3.e. Ground the work or metal to be welded to a good electrical (earth) ground.

3.f. Maintain the electrode holder, work clamp, welding cable and welding machine in good, safe operating condition. Replace damaged insulation.

3.g. Never dip the electrode in water for cooling.

3.h. Never simultaneously touch electrically “hot” parts of electrode holders connected to two welders because voltage between the two can be the total of the open circuit voltage of both welders.

3.i. When working above floor level, use a safety belt to protect yourself from a fall should you get a shock.

3.j. Also see Items 6.c. and 8.



ARC RAYS can burn.

4.a. Use a shield with the proper filter and cover plates to protect your eyes from sparks and the rays of the arc when welding or observing open arc welding. Headshield and filter lens should conform to ANSI Z87.1 standards.

4.b. Use suitable clothing made from durable flame-resistant material to protect your skin and that of your helpers from the arc rays.

4.c. Protect other nearby personnel with suitable, non-flammable screening and/or warn them not to watch the arc nor expose themselves to the arc rays or to hot spatter or metal.



FUMES AND GASES can be dangerous.

5.a. Welding may produce fumes and gases hazardous to health. Avoid breathing these fumes and gases. When welding, keep your head out of the fume. Use enough ventilation and/or exhaust at the arc to keep

fumes and gases away from the breathing zone. **When welding with electrodes which require special ventilation such as stainless or hard facing (see instructions on container or MSDS) or on lead or cadmium plated steel and other metals or coatings which produce highly toxic fumes, keep exposure as low as possible and within applicable OSHA PEL and ACGIH TLV limits using local exhaust or mechanical ventilation. In confined spaces or in some circumstances, outdoors, a respirator may be required. Additional precautions are also required when welding on galvanized steel.**

5. b. The operation of welding fume control equipment is affected by various factors including proper use and positioning of the equipment, maintenance of the equipment and the specific welding procedure and application involved. Worker exposure level should be checked upon installation and periodically thereafter to be certain it is within applicable OSHA PEL and ACGIH TLV limits.

5.c. Do not weld in locations near chlorinated hydrocarbon vapors coming from degreasing, cleaning or spraying operations. The heat and rays of the arc can react with solvent vapors to form phosgene, a highly toxic gas, and other irritating products.

5.d. Shielding gases used for arc welding can displace air and cause injury or death. Always use enough ventilation, especially in confined areas, to insure breathing air is safe.

5.e. Read and understand the manufacturer's instructions for this equipment and the consumables to be used, including the material safety data sheet (MSDS) and follow your employer's safety practices. MSDS forms are available from your welding distributor or from the manufacturer.

5.f. Also see item 1.b.

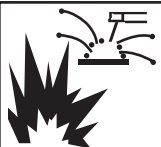

WELDING and CUTTING SPARKS can cause fire or explosion.

6.a. Remove fire hazards from the welding area. If this is not possible, cover them to prevent the welding sparks from starting a fire.

Remember that welding sparks and hot materials from welding can easily go through small cracks and openings to adjacent areas. Avoid welding near hydraulic lines. Have a fire extinguisher readily available.

6.b. Where compressed gases are to be used at the job site, special precautions should be used to prevent hazardous situations. Refer to "Safety in Welding and Cutting" (ANSI Standard Z49.1) and the operating information for the equipment being used.

6.c. When not welding, make certain no part of the electrode circuit is touching the work or ground. Accidental contact can cause overheating and create a fire hazard.

6.d. Do not heat, cut or weld tanks, drums or containers until the proper steps have been taken to insure that such procedures will not cause flammable or toxic vapors from substances inside. They can cause an explosion even though they have been "cleaned". For information, purchase "Recommended Safe Practices for the Preparation for Welding and Cutting of Containers and Piping That Have Held Hazardous Substances", AWS F4.1 from the American Welding Society (see address above).

6.e. Vent hollow castings or containers before heating, cutting or welding. They may explode.

6.f. Sparks and spatter are thrown from the welding arc. Wear oil free protective garments such as leather gloves, heavy shirt, cuffless trousers, high shoes and a cap over your hair. Wear ear plugs when welding out of position or in confined places. Always wear safety glasses with side shields when in a welding area.

6.g. Connect the work cable to the work as close to the welding area as practical. Work cables connected to the building framework or other locations away from the welding area increase the possibility of the welding current passing through lifting chains, crane cables or other alternate circuits. This can create fire hazards or overheat lifting chains or cables until they fail.

6.h. Also see item 1.c.

6.i. Read and follow NFPA 51B "Standard for Fire Prevention During Welding, Cutting and Other Hot Work", available from NFPA, 1 Batterymarch Park, PO box 9101, Quincy, Ma 022690-9101.

6.j. Do not use a welding power source for pipe thawing.



CYLINDER may explode if damaged.

7.a. Use only compressed gas cylinders containing the correct shielding gas for the process used and properly operating regulators designed for the gas and pressure used. All hoses, fittings, etc. should be suitable for the application and maintained in good condition.

7.b. Always keep cylinders in an upright position securely chained to an undercarriage or fixed support.

7.c. Cylinders should be located:

- Away from areas where they may be struck or subjected to physical damage.

- A safe distance from arc welding or cutting operations and any other source of heat, sparks, or flame.

7.d. Never allow the electrode, electrode holder or any other electrically "hot" parts to touch a cylinder.

7.e. Keep your head and face away from the cylinder valve outlet when opening the cylinder valve.

7.f. Valve protection caps should always be in place and hand tight except when the cylinder is in use or connected for use.

7.g. Read and follow the instructions on compressed gas cylinders, associated equipment, and CGA publication P-1, "Precautions for Safe Handling of Compressed Gases in Cylinders," available from the Compressed Gas Association 1235 Jefferson Davis Highway, Arlington, VA 22202.



FOR ELECTRICALLY powered equipment.

8.a. Turn off input power using the disconnect switch at the fuse box before working on the equipment.

8.b. Install equipment in accordance with the U.S. National Electrical Code, all local codes and the manufacturer's recommendations.

8.c. Ground the equipment in accordance with the U.S. National Electrical Code and the manufacturer's recommendations.

Refer to <http://www.lincolnelectric.com/safety> for additional safety information.

PRÉCAUTIONS DE SÛRETÉ

Pour votre propre protection lire et observer toutes les instructions et les précautions de sûreté spécifiques qui paraissent dans ce manuel aussi bien que les précautions de sûreté générales suivantes:

Sûreté Pour Soudage A L'Arc

1. Protégez-vous contre la secousse électrique:
 - a. Les circuits à l'électrode et à la pièce sont sous tension quand la machine à souder est en marche. Eviter toujours tout contact entre les parties sous tension et la peau nue ou les vêtements mouillés. Porter des gants secs et sans trous pour isoler les mains.
 - b. Faire très attention de bien s'isoler de la masse quand on soude dans des endroits humides, ou sur un plancher métallique ou des grilles métalliques, principalement dans les positions assis ou couché pour lesquelles une grande partie du corps peut être en contact avec la masse.
 - c. Maintenir le porte-électrode, la pince de masse, le câble de soudage et la machine à souder en bon et sûr état de fonctionnement.
 - d. Ne jamais plonger le porte-électrode dans l'eau pour le refroidir.
 - e. Ne jamais toucher simultanément les parties sous tension des porte-électrodes connectés à deux machines à souder parce que la tension entre les deux pinces peut être le total de la tension à vide des deux machines.
 - f. Si on utilise la machine à souder comme une source de courant pour soudage semi-automatique, ces précautions pour le porte-électrode s'appliquent aussi au pistolet de soudage.
2. Dans le cas de travail au dessus du niveau du sol, se protéger contre les chutes dans le cas où on recoit un choc. Ne jamais enrouler le câble-électrode autour de n'importe quelle partie du corps.
3. Un coup d'arc peut être plus sévère qu'un coup de soleil, donc:
 - a. Utiliser un bon masque avec un verre filtrant approprié ainsi qu'un verre blanc afin de se protéger les yeux du rayonnement de l'arc et des projections quand on soude ou quand on regarde l'arc.
 - b. Porter des vêtements convenables afin de protéger la peau de soudeur et des aides contre le rayonnement de l'arc.
 - c. Protéger l'autre personnel travaillant à proximité au soudage à l'aide d'écrans appropriés et non-inflammables.
4. Des gouttes de laitier en fusion sont émises de l'arc de soudage. Se protéger avec des vêtements de protection libres de l'huile, tels que les gants en cuir, chemise épaisse, pantalons sans revers, et chaussures montantes.

5. Toujours porter des lunettes de sécurité dans la zone de soudage. Utiliser des lunettes avec écrans latéraux dans les zones où l'on pique le laitier.
6. Eloigner les matériaux inflammables ou les recouvrir afin de prévenir tout risque d'incendie dû aux étincelles.
7. Quand on ne soude pas, poser la pince à un endroit isolé de la masse. Un court-circuit accidentel peut provoquer un échauffement et un risque d'incendie.
8. S'assurer que la masse est connectée le plus près possible de la zone de travail qu'il est pratique de le faire. Si on place la masse sur la charpente de la construction ou d'autres endroits éloignés de la zone de travail, on augmente le risque de voir passer le courant de soudage par les chaînes de levage, câbles de grue, ou autres circuits. Cela peut provoquer des risques d'incendie ou d'échauffement des chaînes et des câbles jusqu'à ce qu'ils se rompent.
9. Assurer une ventilation suffisante dans la zone de soudage. Ceci est particulièrement important pour le soudage de tôles galvanisées plombées, ou cadmiées ou tout autre métal qui produit des fumees toxiques.
10. Ne pas souder en présence de vapeurs de chlore provenant d'opérations de dégraissage, nettoyage ou pistolage. La chaleur ou les rayons de l'arc peuvent réagir avec les vapeurs du solvant pour produire du phosgène (gas fortement toxique) ou autres produits irritants.
11. Pour obtenir de plus amples renseignements sur la sûreté, voir le code "Code for safety in welding and cutting" CSA Standard W 117.2-1974.

PRÉCAUTIONS DE SÛRETÉ POUR LES MACHINES À SOUDER À TRANSFORMATEUR ET À REDRESSEUR

1. Relier à la terre le châssis du poste conformément au code de l'électricité et aux recommandations du fabricant. Le dispositif de montage ou la pièce à souder doit être branché à une bonne mise à la terre.
2. Autant que possible, l'installation et l'entretien du poste seront effectués par un électricien qualifié.
3. Avant de faire des travaux à l'intérieur de poste, la débrancher à l'interrupteur à la boîte de fusibles.
4. Garder tous les couvercles et dispositifs de sûreté à leur place.

Thank You

for selecting a **QUALITY** product by Lincoln Electric. We want you to take pride in operating this Lincoln Electric Company product
••• as much pride as we have in bringing this product to you!

CUSTOMER ASSISTANCE POLICY

The business of The Lincoln Electric Company is manufacturing and selling high quality welding equipment, consumables, and cutting equipment. Our challenge is to meet the needs of our customers and to exceed their expectations. On occasion, purchasers may ask Lincoln Electric for advice or information about their use of our products. We respond to our customers based on the best information in our possession at that time. Lincoln Electric is not in a position to warrant or guarantee such advice, and assumes no liability, with respect to such information or advice. We expressly disclaim any warranty of any kind, including any warranty of fitness for any customer's particular purpose, with respect to such information or advice. As a matter of practical consideration, we also cannot assume any responsibility for updating or correcting any such information or advice once it has been given, nor does the provision of information or advice create, expand or alter any warranty with respect to the sale of our products.

Lincoln Electric is a responsive manufacturer, but the selection and use of specific products sold by Lincoln Electric is solely within the control of, and remains the sole responsibility of the customer. Many variables beyond the control of Lincoln Electric affect the results obtained in applying these types of fabrication methods and service requirements.

Subject to Change – This information is accurate to the best of our knowledge at the time of printing. Please refer to www.lincolnelectric.com for any updated information.

Please Examine Carton and Equipment For Damage Immediately

When this equipment is shipped, title passes to the purchaser upon receipt by the carrier. Consequently, Claims for material damaged in shipment must be made by the purchaser against the transportation company at the time the shipment is received.

Please record your equipment identification information below for future reference. This information can be found on your machine nameplate.

Product _____

Model Number _____

Code Number or Date Code _____

Serial Number _____

Date Purchased _____

Where Purchased _____

Whenever you request replacement parts or information on this equipment, always supply the information you have recorded above. The code number is especially important when identifying the correct replacement parts.

On-Line Product Registration

- Register your machine with Lincoln Electric either via fax or over the Internet.
 - For faxing: Complete the form on the back of the warranty statement included in the literature packet accompanying this machine and fax the form per the instructions printed on it.
 - For On-Line Registration: Go to our **WEB SITE at www.lincolnelectric.com**. Choose "Quick Links" and then "Product Registration". Please complete the form and submit your registration.

Read this Operators Manual completely before attempting to use this equipment. Save this manual and keep it handy for quick reference. Pay particular attention to the safety instructions we have provided for your protection. The level of seriousness to be applied to each is explained below:

⚠ WARNING

This statement appears where the information **must** be followed **exactly** to avoid **serious personal injury** or **loss of life**.

⚠ CAUTION



This statement appears where the information **must** be followed to avoid **minor personal injury** or **damage to this equipment**.

Installation	Section A
Location	A-1
Input Wiring	A-1
Output Connections.....	A-1
a. Wire Feeder Connections	A-1
Ratings:	A-1
Connection of AC-1200 (with NL Option) to LAF or LT34	A-2
Connection of AC-1200 to NA-4 with Switch for 'Current Control'	A-2
Connection of AC-1200 to NA-4 with rheostat for current control or LT-6.....	A-2
b. Output Studs	A-3
c. Auxiliary Power	A-3
Duty Cycle	A-3
<hr/>	
Operation	Section B
Safety Precautions	B-1
To set for machine or Remote Control	B-1
To set Output Current.....	B-1
<hr/>	
Maintenance	Section D
Safety Precautions	D-1
<hr/>	
Troubleshooting	Section E
Safety Precautions.....	E-1
How to Use Troubleshooting Guide.....	E-1
Troubleshooting Guide.....	E-2,E-3
<hr/>	
Wiring Diagrams	Section F
<hr/>	
PARTS PAGES	P-119, P-28, P-84
<hr/>	

LOCATION

Install the welder in a dry location where there is free circulation of air in through the louvers in front and out through the louvers in the back of the case. A location which minimizes the amount of smoke and dirt drawn into the machine reduces the chance of dirt accumulation that can block air passages and cause overheating.

INPUT WIRING

 WARNING	
	<ul style="list-style-type: none"> • Have an electrician install and service this equipment. • Turn the input power off at the fuse box before working on equipment. • Do not touch electrically hot parts.
ELECTRIC SHOCK can kill.	

Failure to fuse the input lines per the specifications in this manual will constitute customer abuse and void the warranty.

Have a qualified electrician make the complete input connection in accordance with the National Electrical Code, all local codes and the connection diagram located inside the machine.

Be sure the voltage, phase and frequency of the input power is as specified on the welder nameplate.

For most installations, connect the AC-1200 to single phase power or to one phase of a three phase line. Unbalanced line conditions can be easily avoided by properly balancing the AC-1200 with other machinery on the lines.

When installing two or four Scott connected AC-1200 machines for AC-AC tandem arc welding, three phase input power must be used. The terminals for connections to provide an output phase angle less than or greater than the usual 90° phase angle are included on the input panel.

The AC-1200 does not have an input contactor. Therefore, include an external starter or disconnect switch when planning the input circuit.

Remove the right side panel of the AC-1200 and bring the input power lines through the hole in the back of the case. See the table below for recommended sizing of input leads and overcurrent protection.

The frame of the welder must be grounded, A stud marked with the symbol  located on the welder case back hole in the back of the case is provided for this purpose. See the National Electrical Code for details on proper grounding methods.

OUTPUT CONNECTIONS

a. Wire Feeder Connection
 Turn the input power to the welder off. Remove the screw and lift the hinged door on the front of the control panel to expose the terminal strips. Connect the leads of the wire feeder input control cable to the terminal strips exactly as specified in the appropriate connection diagram. The AC-1200 to NA-4 connection diagrams are included in the NA-4 Operating Manual IM-278. Attach the control cables to the panel at the right of the terminal strip using the clamps provided.

If connecting the AC-1200 to an older NA-4 with the toggle switch type 'Current Control' (below code 7532), a K-775 'Remote Control' must be purchased and installed in accordance with the connection diagram S-15667 on page 5. The 'Remote Control' cord can be lengthened to any length by properly splicing a four conductor cord to the standard 25' cord before connecting to the AC-1200 terminal strip.

If connecting the AC-1200 to an LAF-4 or the AC controls of the LT-34 tractor, the AC-1200 must be ordered with the required '-NL' optional circuit installed. This kit includes the K-775 'Remote Control'. Connect in accordance with diagram S-15666 on page 5.

To connect the AC-1200 to any other wire feeder, write to the factory for instructions giving complete nameplate information for the specific equipment.

When connection to the terminal strips are completed, close the door and replace the screw.

RATING: IP21 ENCLOSURE, INSULATION 155(F)

Recommended Input Wire, Grounding Conductor and Fuse Sizes
 Based on National Electrical Code - 100% Duty Cycle 40°C (104°F) Ambient

Input Voltage/ Hertz	Input Amps		Copper Wire Size - 75°C in Conduit								Super Lag Fuses Size in Amps	
			Power Input Wires				Grounding Conductor					
	1 Phase	Scott Conn.	1 Phase	T & B Term.	Scott Conn.	T & B Term.	1 Phase	T & B Term.	Scott Conn.	T & B Term.	1 Phase	Scott Conn.
460/60	182	209	#4/0	31013	250MCM	31013	#4	31007	#3	31007	300	350
440/50/60	190	219	#4/0	31013	250MCM	31013	#4	31007	#3	31007	300	350
380/50/60	230	254	250MCM	31013	350MCM	31015	#3	31007	#3	31007	300	400

Thomas & Betts wire terminals (or equal) recommended above are required to comply with applicable U.L. standards for safety. A #30 hex (Allen) key wrench is required for assembly of terminals to wire.

Connection of AC-1200 (with NL Option) to LAF-4 or LT-34 S-15666
4-18-75

Connection of AC-1200 to NA-4 with Switch for 'Current Control' S-15667
4-18-75

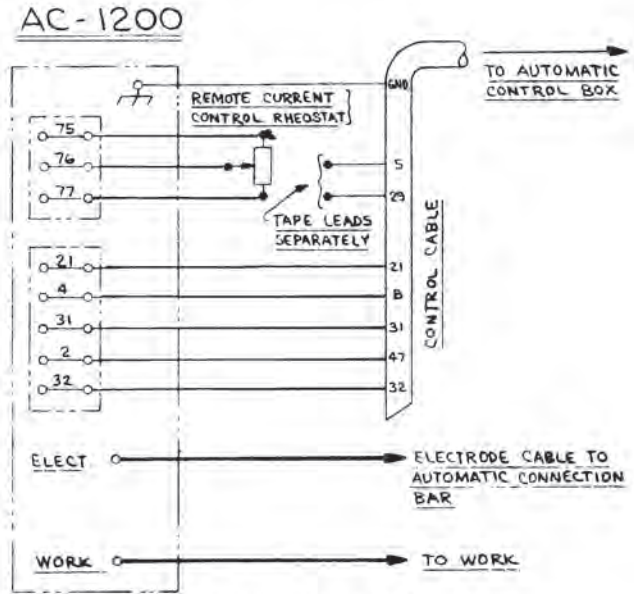
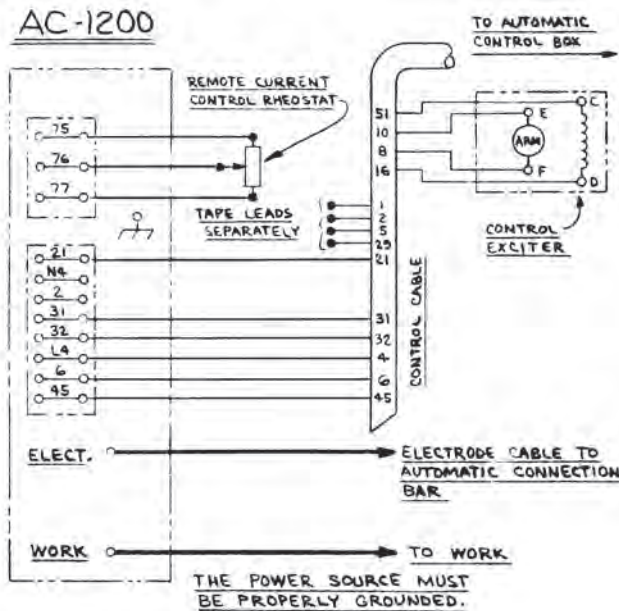

FOR NA-4 WITH CODES 7531 AND LOWER
CONNECT THE CONTROL CABLE GROUND LEAD TO THE FRAME TERMINAL MARKED ⏏ NEAR THE POWER SOURCE TERMINAL STRIP.
THE POWER SOURCE MUST BE PROPERLY GROUNDED.

Connection of AC-1200 to NA-4 with rheostat for current control or LT-6.

WARNING: Turn power source off before making these connections. Connect the control cable ground lead to the frame terminal marked ⏏ near the power source terminal strip. The power source grounding terminal (marked and located near the power source input power connections) must also be connected to electrical ground per the power source Operating Manual.

N.A. Welding cables must be of proper capacity for the current and duty cycle of immediate and future applications. See the Operating Manual for proper sizes.

N.B. Extend lead 21 using #14 or larger insulated wire physically suitable for the installation. An S-16586-^{LENGTH} remote voltage sensing work lead is available for this purpose. Connect it directly to the work piece keeping it electrically separate from the welding work lead circuit and connection.

N.C. If using an older control cable: connect lead #75 to #75 on terminal strip, connect lead #76 to #76 on terminal strip, connect lead #77 to #77 on terminal strip.

N.D. To avoid possible induced NA-4 or LT-6 meter reading error; keep the control leads, including the extended #21 lead separated from the A.C. welding cables by at least 12 inches.

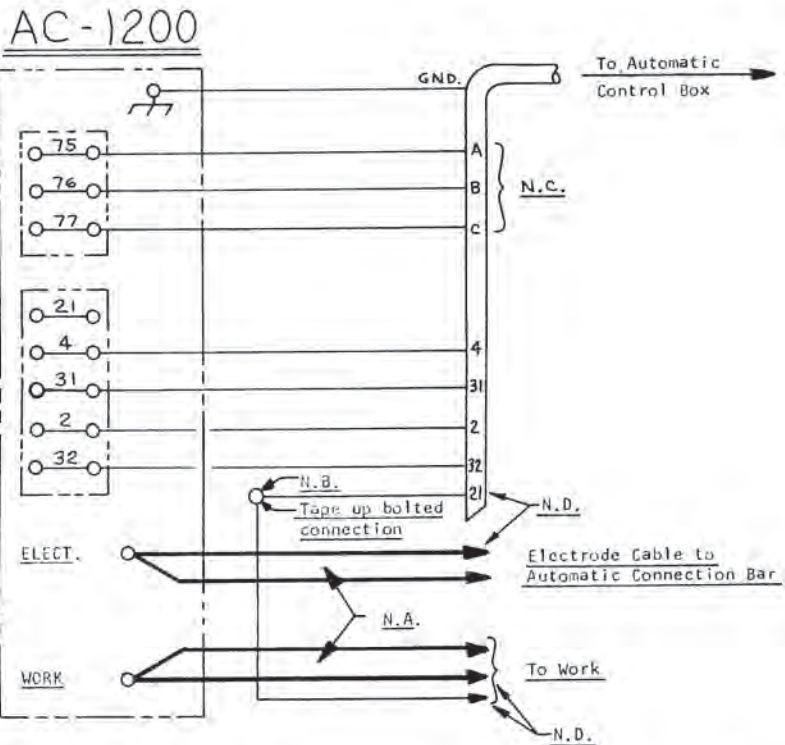

S-15602
6-22-84H

b. Output Studs

Connect the work cables to the 'To Work' stud on the front of the Ac-1200. Connect the electrode cables to the 'Min,' 'Med' or 'Max' studs for the output desired. Actual current ranges for each stud are indicated on the nameplate above each stud. Recommended cable sizes are listed below. Both the 'To Work' and 'Max' studs have two terminals to simplify connection of recommended cables in parallel. Tighten the nuts with a wrench.

Select cables required for combined work and electrode cable lengths up to 150' from the following table:

Duty Cycle	One 4/0	Two 4/0	Three 4/0	Four 4/0
100%	500	930	1150	1350
80%*	560	1040	1290	1510

* Based on 10 minute cycle.

Maximum Allowable Current for Copper Welding Cable

Cables in accessory kit recommended below have terminals as required to comply with applicable U.L. standards for safety.

150' combined length electrode and work cables.

c. Auxiliary Power

1000 volt-amperes of 115 volt AC power are available from #31 and #32 on the AC-1200 terminal strip.

DUTY CYCLE

The AC-1200 is rated for 100% duty cycle at 1200 amps and 44 volts.

SAFETY PRECAUTIONS

Read and understand this entire section before operating the machine.

WARNING



ELECTRIC SHOCK can kill.

- Do not touch electrically live parts or electrode with skin or wet clothing.
- Insulate yourself from work and ground.
- Always wear dry insulating gloves.



FUMES AND GASES can be dangerous.

- Keep your head out of fumes.
- Use ventilation or exhaust to remove fumes from breathing zone.



WELDING SPARKS can cause fire or explosion

- Keep flammable material away.
- Do not weld on containers that have held combustibles.



ARC RAYS can burn.

- Wear eye, ear and body protection.

Observe additional Safety Guidelines detailed throughout this manual.

TO SET FOR MACHINE OR REMOTE CONTROL

The output can be controlled either from the AC-1200, the wire feeder or other remote locations.

To adjust the current from the wire feeder or other remote locations, set the toggle switch on the front of the AC-1200 to 'Output Control Remote'. To adjust the output current from the AC-1200, set this switch to 'Output Control at AC-1200'.

TO SET THE OUTPUT CURRENT

Start the AC-1200 using the line disconnect switch or breaker installed with the input wiring. The red pilot light on the front panel indicates when the welder is on.

Adjust the output current from minimum to maximum within the range set by the output stud connections using either the 'Output Control' rheostat on the AC-1200 (toggle switch set on 'Panel Control') or the wire feeder or other remote rheostat (toggle switch set on 'Output Control Re-mote').

TO WELD WITH MANUAL ELECTRODES

Turn the welder off, disconnect the wire feeder leads and connect a jumper between #2 and #4 on the AC-1200 terminal strip. This closes the output contactors making the output studs electrically 'hot' whenever the machine is on. Adjust the output current as described above. Caution: If the wire feeder electrode cables are left connected to the output studs, the wire feeder nozzle and electrode will be electrically 'hot'.

SAFETY PRECAUTIONS

WARNING



ELECTRIC SHOCK can kill.

- Have qualified personnel do the maintenance and troubleshooting work.

- Turn the input power OFF at the disconnect switch or fuse box before working on this equipment.
- Do not touch electrically live parts or electrode with skin or wet clothing.
- Insulate yourself from work and ground.
- Always wear dry insulating gloves.

See additional warning information throughout this operator's manual.

1. Every three months, blow out the machine with compressed air. More frequent cleaning may be necessary in areas with chemical or metallic particles and large quantities of dust.
2. The fan motors have sealed bearings which require no service.

HOW TO USE TROUBLESHOOTING GUIDE

WARNING

Service and Repair should only be performed by Lincoln Electric Factory Trained Personnel. Unauthorized repairs performed on this equipment may result in danger to the technician and machine operator and will invalidate your factory warranty. For your safety and to avoid Electrical Shock, please observe all safety notes and precautions detailed throughout this manual.

This Troubleshooting Guide is provided to help you locate and repair possible machine malfunctions. Simply follow the three-step procedure listed below.

Step 1. LOCATE PROBLEM (SYMPTOM).

Look under the column labeled “PROBLEM (SYMPTOMS)”. This column describes possible symptoms that the machine may exhibit. Find the listing that best describes the symptom that the machine is exhibiting.

Step 2. POSSIBLE CAUSE.

The second column labeled “POSSIBLE CAUSE” lists the obvious external possibilities that may contribute to the machine symptom.

Step 3. RECOMMENDED COURSE OF ACTION

This column provides a course of action for the Possible Cause, generally it states to contact your local Lincoln Authorized Field Service Facility.

If you do not understand or are unable to perform the Recommended Course of Action safely, contact your local Lincoln Authorized Field Service Facility.

CAUTION

If for any reason you do not understand the test procedures or are unable to perform the tests/repairs safely, contact your **Local Lincoln Authorized Field Service Facility** for technical troubleshooting assistance before you proceed.

Observe all Safety Guidelines detailed throughout this manual

PROBLEMS (SYMPTOMS)	POSSIBLE CAUSE	RECOMMENDED COURSE OF ACTION
Welder will not start.	Supply line fuse blown. Open supply line lead. Wrong supply line voltage.	Look for possible cause and repair. Replace fuse. Repair. Provide nameplate specified voltage.
Welder will not weld (Contactors operating properly)	Electrode or ground cable loose or broken. Welder control circuit dead: No voltage across Control Transformer X1-X2.	Tighten connection or repair broken cable. Check Control Transformer primary voltage and if OK, replace transformer.
Welder will not weld (Contactors not operating).	Thermostat on coil tripped. Welder overheated (Fan motors operating). Fuse (or thermostat – below code 7600) on control panel open; Control circuit overloaded. (Fan motors operating) Circuit across #2 and #4 not working properly. Wire feeder control power; No voltage across #31 and #32.	Check operation of fans and make sure there is no obstruction to air flow. Do not operate in excess of welder rating. SCR's or diodes on heat sink assembly or P.C. board failed –see Trouble "Welder welds at max. or min. only – no control". Make repairs and replace fuse. Check connections at terminal strip and wire feeder. Relay contacts not closing. Repair as required. Check fuse and replace if no good.
Welder welds at min. only no control.	Remote control switch in wrong position. Control rheostat open. Control circuit open. Open saturable reactor control coil or connection.	Switch to 'Panel Control' for welder rheostat. Control and "Remote Control" for other control. Replace rheostat. 1. No voltage across #41 and #44 – Repair broken leads or reconnect loose leads. 2. Diodes or SCR's on heat sinks open or disconnected. Repair or replace. 3. P.C. board plug disconnected – Check plug connection and plug in properly. 4. P.C. board failed. Determine cause and replace board. 5. Open circuit at R ₁ – Repair or replace. Repair connection or replace coil.

 **CAUTION**

If for any reason you do not understand the test procedures or are unable to perform the tests/repairs safely, contact your **Local Lincoln Authorized Field Service Facility** for technical troubleshooting assistance before you proceed.

IDEALARC® AC-1200



PROBLEMS (SYMPTOMS)	POSSIBLE CAUSE	RECOMMENDED COURSE OF ACTION
Welder welds at max. only no control.	Diodes or SCR's on heat sink assemblies shorted. Shorted or grounded current control rheostat. Output By-Pass Capacitors open or disconnected. Free wheeling diode open or disconnected. P.C. board components failed.	Determine cause if possible and replace shorted device. Replace rheostat. Replace or reconnect. Replace or reconnect. Determine cause if possible and replace P.C. board.
Contacts chatter.	Low supply line voltage. Faulty contactor.	Check with Power Company. Repair or replace.

⚠ CAUTION

If for any reason you do not understand the test procedures or are unable to perform the tests/repairs safely, contact your **Local Lincoln Authorized Field Service Facility** for technical troubleshooting assistance before you proceed.

IDEALARC® AC-1200



IDEALARC AC-1200 WIRING DIAGRAM-CODES 10465 & 10466

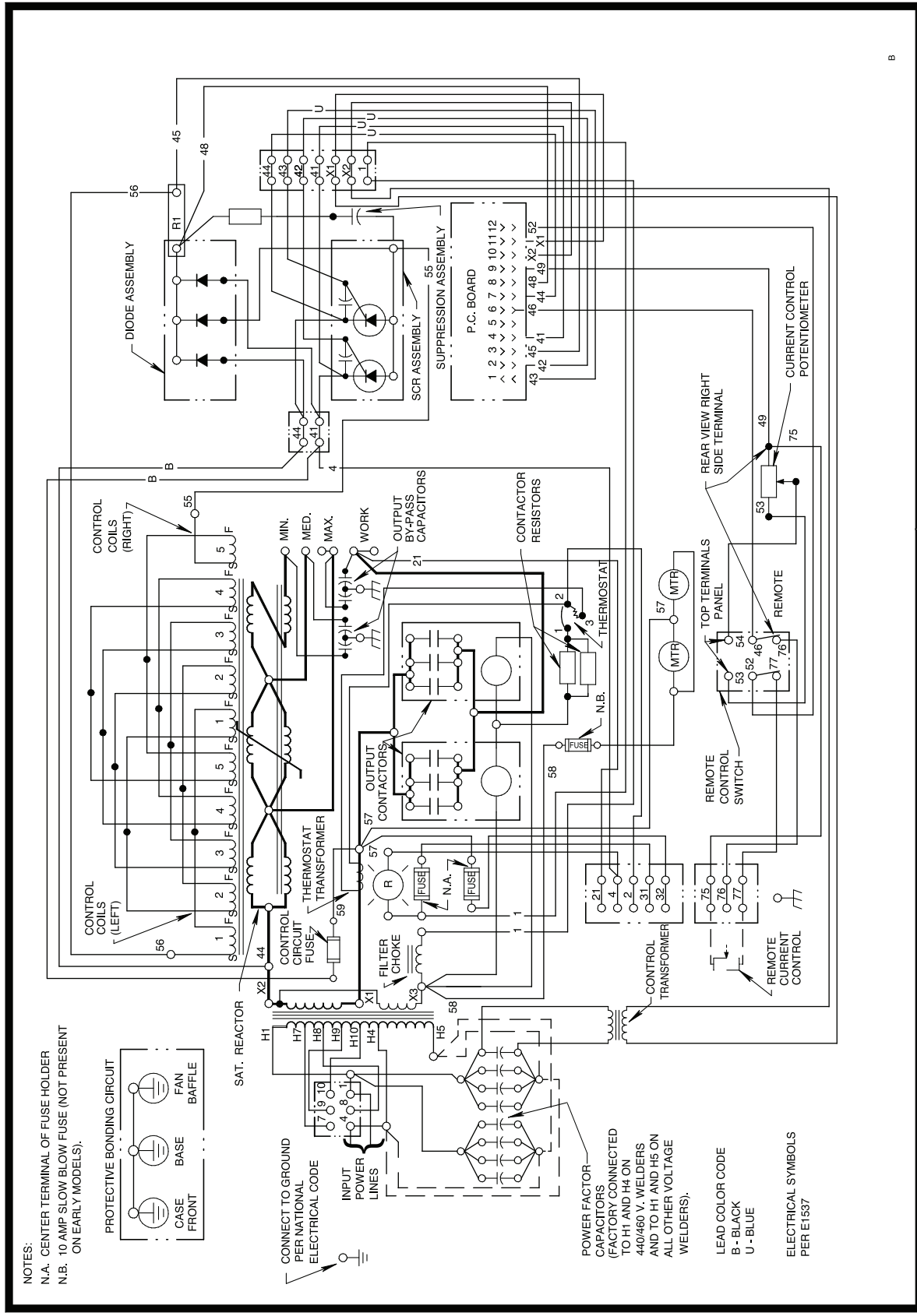

M18868

NOTE: This diagram is for reference only. It may not be accurate for all machines covered by this manual. The specific diagram for a particular code is pasted inside the machine on one of the enclosure panels. If the diagram is illegible, write to the Service Department for a replacement. Give the equipment code number.

AC-1200 SCOTT CONNECTION DIAGRAM

TWO SINGLE MACHINES SCOTT CONNECTED

WARNING

ELECTRIC SHOCK CAN KILL

- Disconnect input power before servicing.
- Do not operate with covers removed.
- Do not touch electrically live parts.
- Only qualified persons should install, use or service this equipment.

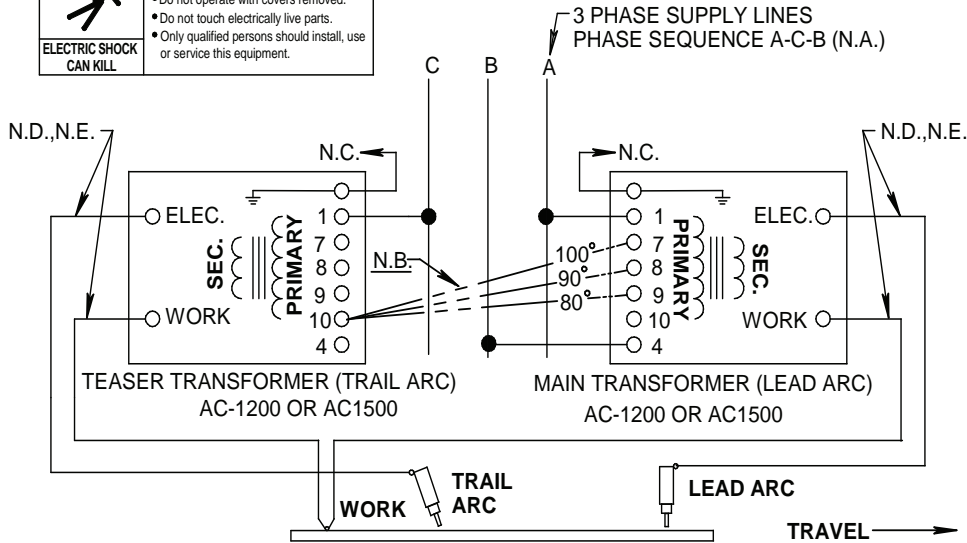

NOTE: The two arcs must be properly phased relative to each other, if the electrical connections are not as shown above, poor welding will result.

A way to verify the proper phase angle and phase sequence is to measure the A.C. voltage at the welding nozzles.

1. **Do not weld** during the voltage measurements. Back the electrode out of each wire drive, then press the NA-4 start buttons.

CAUTION - Voltage will be high between the two electrode nozzles.

2. Voltage readings between nozzles to work, and nozzle to nozzle should be per table:

PHASE ANGLE	LEAD ARC TO WORK V	TRAIL ARC TO WORK V	LEAD ARC TO TRAIL ARC	
			Value	Relationship
100°	90 VAC	90 VAC	138 VAC	1.53 x V
90°	90 VAC	90 VAC	127 VAC	1.41 x V
80°	90 VAC	90 VAC	116 VAC	1.29 x V

If voltages do not agree, recheck all wiring and the proper sequence of the input supply lines.

* If using the 90° phase angle connection, the phase sequence cannot be determined by voltage measurement. To determine the phase sequence use one of the following methods.

1. Use a phase meter.
2. Use an oscilloscope.
3. Temporarily reconnect the machine to either the 100° tap or the 80° tap and check the voltage per note 2.

N.A. To obtain proper phase sequence at the welding arcs, the input line sequence must be A-C-B.

N.B. Interconnect machines as shown for the desired phase angle.

N.C. Frames of all welding power sources must be grounded per National Electric Code.

N.D. Electrode cables of paralleled machines should be connected to the same range tap.

N.E. The weld cables for each arc, and work must be of proper capacity for the current and duty cycle of the immediate and future applications.

B

M13026

IDEALARC® AC-1200



AC-1200 SCOTT CONNECTION DIAGRAM

TWO PARALLEL MACHINES SCOTT CONNECTED TO TWO OTHER PARALLEL MACHINES

FOR DESIRED PHASE ANGLE, INTERCONNECT MACHINES (AS SHOWN BELOW). BOTH PHASE ANGLES MUST BE THE SAME.

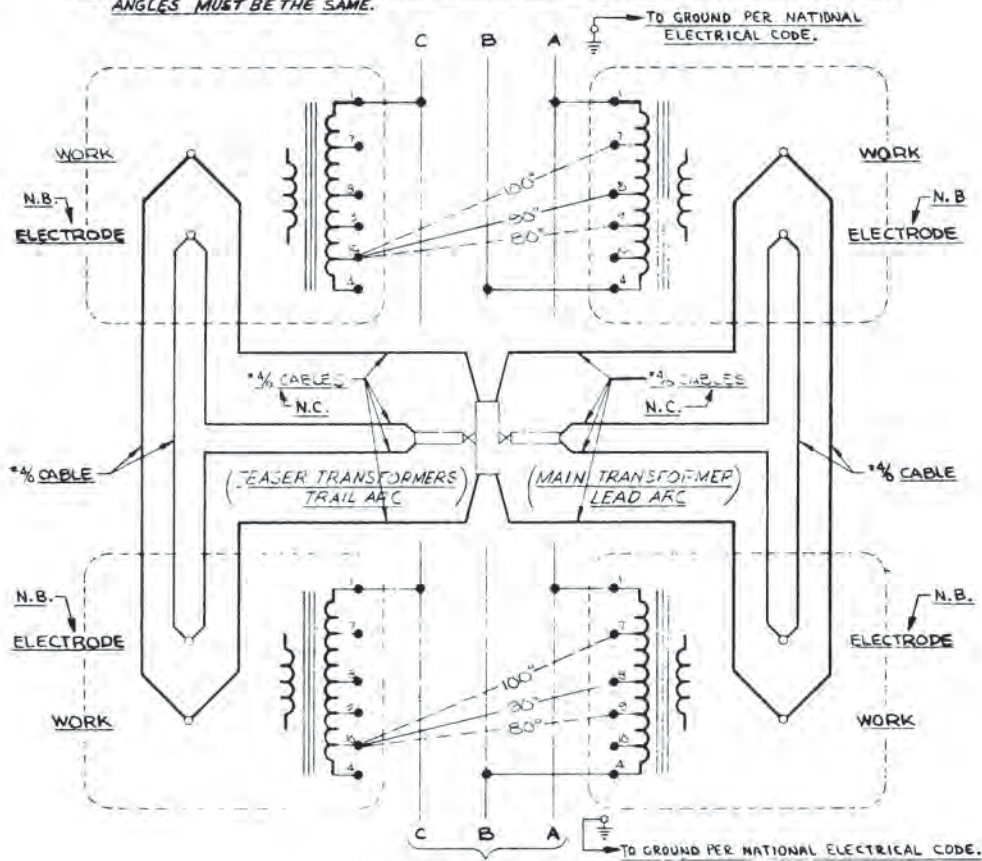
3 PHASE SUPPLY LINES (N.A.)

N.A. TO OBTAIN NORMAL PHASE SEQUENCE AT THE WELDING ARCS, THE INPUT LINE PHASE SEQUENCE SHOULD BE A-C-B.

N.B. ELECTRODE CABLES OF PARALLELED MACHINES SHOULD BE CONNECTED TO THE SAME RANGE TAP.

N.C. NUMBER OF 3/4" CABLES CONNECTED: 1 ON MIN. TAP; 2 PARALLEL ON MED. TAP; 3 PARALLEL ON MAX. TAP.

AC-1200 AND PARALLELED DC-1000's

DOUBLE TANDEM ARC WELDING

DC, AC, AC, AC (LAST TWO ARCS SCOTT CONNECTED)
 FRAMES OF ALL WELDING POWER SOURCES MUST BE GROUNDED
 PER NATIONAL ELECTRIC CODE

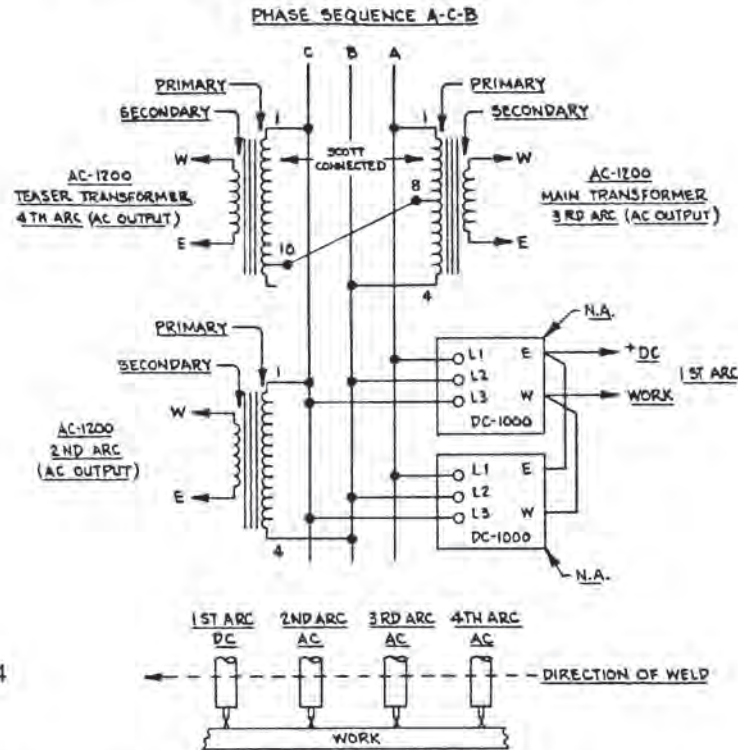

NOTE: THE THREE AC ARCS MUST BE PROPERLY PHASED RELATIVE TO EACH OTHER. IF THE ELECTRICAL CONNECTIONS ARE NOT AS SHOWN ABOVE, POOR WELDING WILL RESULT.

(A) ONE WAY TO VERIFY PROPER PHASE ANGLE AND PHASE SEQUENCE IS TO USE AN OSCILLOSCOPE AS FOLLOWS:

- 1.) DO NOT WELD DURING THE FOLLOWING MEASUREMENTS. BACK THE ELECTRODE OUT OF THE DRIVE ROLLS. PRESS THE NA-4 START BUTTONS.
- 2.) EXTERNALLY TRIGGER THE SCOPE FROM THE VOLTAGE ON THE 4TH NOZZLE.
- 3.) CONNECT THE SCOPE INPUT TO EACH AC NOZZLE AND NOTE THE TIME OR PHASE DIFFERENCE BETWEEN ALL THREE. THEY SHOULD LOOK LIKE FIG. 1.

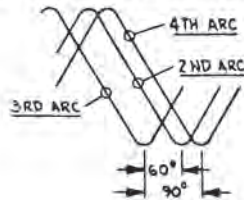

FIG. 1

PHASE ANGLE	50 HZ TIME	60 HZ TIME
60°	3.3 m sec.	2.8 m sec.
90°	5.0 m sec.	4.2 m sec.

(B) ANOTHER WAY TO VERIFY PROPER PHASE ANGLE AND PHASE SEQUENCE IS TO MEASURE THE AC VOLTAGES BETWEEN THE NOZZLES.

- 1.) DO NOT WELD DURING THE FOLLOWING MEASUREMENTS. BACK THE ELECTRODE OUT OF THE DRIVE ROLLS. PRESS THE NA-4 START BUTTONS.
- 2.) THE VOLTAGE READINGS BETWEEN THE NOZZLES SHOULD BE PER THE TABLE BELOW.

	WELDER OCV 2ND ARC NOZZLE TO WORK	VOLTAGE BETWEEN 2ND & 3RD ARC NOZZLES	VOLTAGE BETWEEN 3RD & 4TH ARC NOZZLES	VOLTAGE BETWEEN 2ND & 4TH ARC NOZZLES
VOLTAGE RELATIONSHIPS →	V	V	1.41 V	.52 V
VALUES AT RATED INPUT VOLTS (60 HZ)	90	90	127	47

IF THE VOLTAGE READINGS DO NOT AGREE, RE-CHECK ALL WIRING AND FOR PROPER PHASE SEQUENCE OF THE INPUT SUPPLY LINES.

N.A. REFER TO DC-1000 PARALLELING KIT (T-14400). KIT CONTAINS CONTROL CABLE ASSEMBLY AND PARALLELING DIAGRAM INSTRUCTION SHEET. DIAGRAM SHOWS DETAILED INFORMATION FOR PARALLELING W/RTH OUTPUTS AND CONTROL LEADS.

AC-1200 AND DC-1500's

DOUBLE TANDEM ARC WELDING

DC, AC, AC, AC (LAST TWO ARCS SCOTT CONNECTED)
 FRAMES OF ALL WELDING POWER SOURCES MUST BE GROUNDED
 PER NATIONAL ELECTRIC CODE.

PHASE SEQUENCE A-C-B

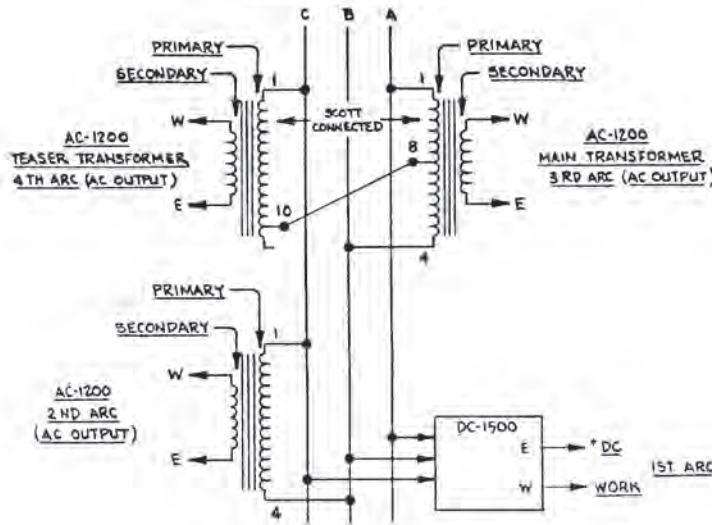

M-14364-1
 4-8-83

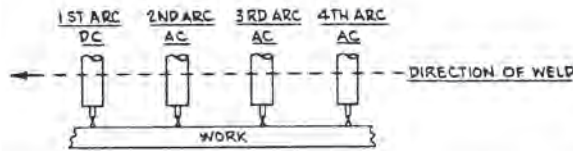

NOTE: THE THREE AC ARCS MUST BE PROPERLY PHASED RELATIVE TO EACH OTHER. IF THE ELECTRICAL CONNECTIONS ARE NOT AS SHOWN ABOVE, POOR WELDING WILL RESULT.

- (A) ONE WAY TO VERIFY PROPER PHASE ANGLE AND PHASE SEQUENCE IS TO USE AN OSCILLOSCOPE AS FOLLOWS:
- DO NOT WELD DURING THE FOLLOWING MEASUREMENTS. BACK THE ELECTRODE OUT OF THE DRIVE ROLLS. PRESS THE NA-4 START BUTTONS.
 - EXTERNALLY TRIGGER THE SCOPE FROM THE VOLTAGE ON THE 4TH NOZZLE.
 - CONNECT THE SCOPE INPUT TO EACH AC NOZZLE AND NOTE THE TIME OR PHASE DIFFERENCE BETWEEN ALL THREE. THEY SHOULD LOOK LIKE FIG. 1.

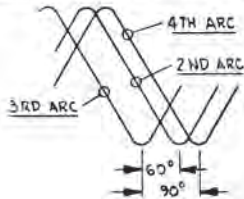

PHASE ANGLE	50 HZ TIME	60 HZ TIME
60°	3.3 m sec.	2.8 m sec.
90°	5.0 m sec.	4.2 m sec.

FIG. 1

- (B) ANOTHER WAY TO VERIFY PROPER PHASE ANGLE AND PHASE SEQUENCE IS TO MEASURE THE AC VOLTAGES BETWEEN THE NOZZLES.
- DO NOT WELD DURING THE FOLLOWING MEASUREMENTS. BACK THE ELECTRODE OUT OF THE DRIVE ROLLS. PRESS THE NA-4 START BUTTONS.
 - THE VOLTAGE READINGS BETWEEN THE NOZZLES SHOULD BE PER THE TABLE BELOW.

WELDER OCV 2ND ARC NOZZLE TO WORK	VOLTAGE BETWEEN 2ND & 3RD ARC NOZZLES	VOLTAGE BETWEEN 3RD & 4TH ARC NOZZLES	VOLTAGE BETWEEN 2ND & 4TH ARC NOZZLES
V	V	1.41 V	.52 V
VALUES AT RATED INPUT VOLTS (60 HZ)	90	127	47

IF THE VOLTAGE READINGS DO NOT AGREE, RE-CHECK ALL WIRING AND FOR PROPER PHASE SEQUENCE OF THE INPUT SUPPLY LINES.

AC-1200 WIRING DIAGRAM (With NL Option)

NOTE: This diagram is for reference only. It is not accurate for all machines covered by this manual. The specific diagram for a particular code is pasted inside the machine on one of the enclosure panels. If the diagram is illegible, write to the Service Department for a replacement. Give the welder code number.

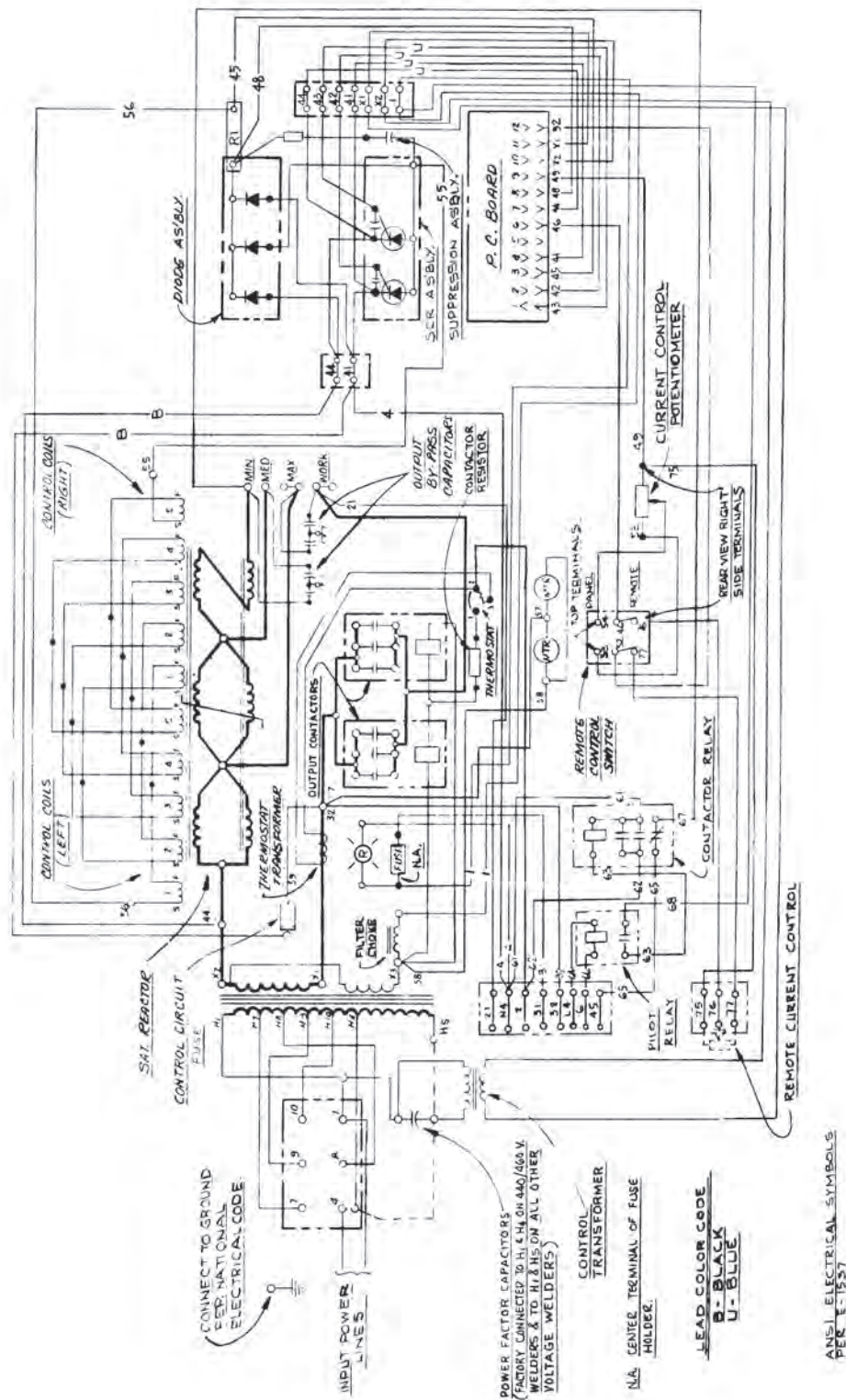

M-14315
6-5-81H

NOTES

NOTES

NOTES

			
WARNING	<ul style="list-style-type: none"> Do not touch electrically live parts or electrode with skin or wet clothing. Insulate yourself from work and ground. 	<ul style="list-style-type: none"> Keep flammable materials away. 	<ul style="list-style-type: none"> Wear eye, ear and body protection.
Spanish AVISO DE PRECAUCION	<ul style="list-style-type: none"> No toque las partes o los electrodos bajo carga con la piel o ropa mojada. Aíslese del trabajo y de la tierra. 	<ul style="list-style-type: none"> Mantenga el material combustible fuera del área de trabajo. 	<ul style="list-style-type: none"> Protéjase los ojos, los oídos y el cuerpo.
French ATTENTION	<ul style="list-style-type: none"> Ne laissez ni la peau ni des vêtements mouillés entrer en contact avec des pièces sous tension. Isolez-vous du travail et de la terre. 	<ul style="list-style-type: none"> Gardez à l'écart de tout matériel inflammable. 	<ul style="list-style-type: none"> Protégez vos yeux, vos oreilles et votre corps.
German WARNUNG	<ul style="list-style-type: none"> Berühren Sie keine stromführenden Teile oder Elektroden mit Ihrem Körper oder feuchter Kleidung! Isolieren Sie sich von den Elektroden und dem Erdboden! 	<ul style="list-style-type: none"> Entfernen Sie brennbares Material! 	<ul style="list-style-type: none"> Tragen Sie Augen-, Ohren- und Körperschutz!
Portuguese ATENÇÃO	<ul style="list-style-type: none"> Não toque partes elétricas e electrodos com a pele ou roupa molhada. Isole-se da peça e terra. 	<ul style="list-style-type: none"> Mantenha inflamáveis bem guardados. 	<ul style="list-style-type: none"> Use proteção para a vista, ouvido e corpo.
Japanese 注意事項	<ul style="list-style-type: none"> ● 通電中の電気部品、又は溶材にヒブやぬれた布で触れないこと。 ● 施工物やアースから身体が絶縁されている様にして下さい。 	<ul style="list-style-type: none"> ● 燃えやすいものの側での溶接作業は絶対にしてはなりません。 	<ul style="list-style-type: none"> ● 目、耳及び身体に保護具をして下さい。
Chinese 警告	<ul style="list-style-type: none"> ● 皮肤或湿衣物切勿接触带电部件及焊条。 ● 使你自己与地面和工件绝缘。 	<ul style="list-style-type: none"> ● 把一切易燃物品移离工作场所。 	<ul style="list-style-type: none"> ● 佩戴眼、耳及身体劳动保护用具。
Korean 위험	<ul style="list-style-type: none"> ● 전도체나 용접봉을 젖은 헝겍 또는 피부로 절대 접촉치 마십시오. ● 모재와 접지를 접촉치 마십시오. 	<ul style="list-style-type: none"> ● 인화성 물질을 접근시키지 마십시오. 	<ul style="list-style-type: none"> ● 눈, 귀와 몸에 보호장구를 착용하십시오.
Arabic تحذير	<ul style="list-style-type: none"> ● لا تلمس الاجزاء التي يسري فيها التيار الكهربائي أو الألكترود بجك الجسم أو بالملابس المبللة بالماء. ● ضع عازلا على جسمك خلال العمل. 	<ul style="list-style-type: none"> ● ضع المواد القابلة للاشتعال في مكان بعيد. 	<ul style="list-style-type: none"> ● ضع أدوات وملابس واقية على عينيك وأذنيك وجسمك.

READ AND UNDERSTAND THE MANUFACTURER'S INSTRUCTION FOR THIS EQUIPMENT AND THE CONSUMABLES TO BE USED AND FOLLOW YOUR EMPLOYER'S SAFETY PRACTICES.

SE RECOMIENDA LEER Y ENTENDER LAS INSTRUCCIONES DEL FABRICANTE PARA EL USO DE ESTE EQUIPO Y LOS CONSUMIBLES QUE VA A UTILIZAR, SIGA LAS MEDIDAS DE SEGURIDAD DE SU SUPERVISOR.

LISEZ ET COMPRENEZ LES INSTRUCTIONS DU FABRICANT EN CE QUI REGARDE CET EQUIPMENT ET LES PRODUITS A ETRE EMPLOYES ET SUIVEZ LES PROCEDURES DE SECURITE DE VOTRE EMPLOYEUR.

LESEN SIE UND BEFOLGEN SIE DIE BETRIEBSANLEITUNG DER ANLAGE UND DEN ELEKTRODENEINSATZ DES HERSTELLERS. DIE UNFALLVERHÜTUNGSVORSCHRIFTEN DES ARBEITGEBERS SIND EBENFALLS ZU BEACHTEN.

			
<ul style="list-style-type: none"> • Keep your head out of fumes. • Use ventilation or exhaust to remove fumes from breathing zone. 	<ul style="list-style-type: none"> • Turn power off before servicing. 	<ul style="list-style-type: none"> • Do not operate with panel open or guards off. 	WARNING
<ul style="list-style-type: none"> • Los humos fuera de la zona de respiración. • Mantenga la cabeza fuera de los humos. Utilice ventilación o aspiración para gases. 	<ul style="list-style-type: none"> • Desconectar el cable de alimentación de poder de la máquina antes de iniciar cualquier servicio. 	<ul style="list-style-type: none"> • No operar con panel abierto o guardas quitadas. 	Spanish AVISO DE PRECAUCION
<ul style="list-style-type: none"> • Gardez la tête à l'écart des fumées. • Utilisez un ventilateur ou un aspirateur pour ôter les fumées des zones de travail. 	<ul style="list-style-type: none"> • Débranchez le courant avant l'entretien. 	<ul style="list-style-type: none"> • N'opérez pas avec les panneaux ouverts ou avec les dispositifs de protection enlevés. 	French ATTENTION
<ul style="list-style-type: none"> • Vermeiden Sie das Einatmen von Schweißrauch! • Sorgen Sie für gute Be- und Entlüftung des Arbeitsplatzes! 	<ul style="list-style-type: none"> • Strom vor Wartungsarbeiten abschalten! (Netzstrom völlig öffnen; Maschine anhalten!) 	<ul style="list-style-type: none"> • Anlage nie ohne Schutzgehäuse oder Innenschutzverkleidung in Betrieb setzen! 	German WARNUNG
<ul style="list-style-type: none"> • Mantenha seu rosto da fumaça. • Use ventilação e exaustão para remover fumo da zona respiratória. 	<ul style="list-style-type: none"> • Não opere com as tampas removidas. • Desligue a corrente antes de fazer serviço. • Não toque as partes elétricas nuas. 	<ul style="list-style-type: none"> • Mantenha-se afastado das partes moventes. • Não opere com os painéis abertos ou guardas removidas. 	Portuguese ATENÇÃO
<ul style="list-style-type: none"> ● ヒュームから頭を離すようにして下さい。 ● 換気や排煙に十分留意して下さい。 	<ul style="list-style-type: none"> ● メンテナンス・サービスに取りかかる際には、まず電源スイッチを必ず切して下さい。 	<ul style="list-style-type: none"> ● パネルやカバーを取り外したまま機械操作をしないで下さい。 	Japanese 注意事項
<ul style="list-style-type: none"> ● 頭部遠離煙霧。 ● 在呼吸區使用通風或排風器除煙。 	<ul style="list-style-type: none"> ● 維修前切斷電源。 	<ul style="list-style-type: none"> ● 儀表板打開或沒有安全罩時不準作業。 	Chinese 警告
<ul style="list-style-type: none"> ● 얼굴로부터 용접가스를 멀리하십시오. ● 호흡지역으로부터 용접가스를 제거하기 위해 가스제거기나 통풍기를 사용하십시오. 	<ul style="list-style-type: none"> ● 보수전에 전원을 차단하십시오. 	<ul style="list-style-type: none"> ● 관널이 열린 상태로 작동치 마십시오. 	Korean 위험
<ul style="list-style-type: none"> ● ابعء رأسك بعيداً عن الدخان. ● استعمل التهوية أو جهاز ضغط الدخان للخارج لكي تبعد الدخان عن المنطقة التي تتنفس فيها. 	<ul style="list-style-type: none"> ● اقطع التيار الكهربائي قبل القيام بأية صيانة. 	<ul style="list-style-type: none"> ● لا تشغيل هذا الجهاز اذا كانت الاعطية الحديدية الواقية ليست عليه. 	Arabic تحذير

LEIA E COMPREENDA AS INSTRUÇÕES DO FABRICANTE PARA ESTE EQUIPAMENTO E AS PARTES DE USO, E SIGA AS PRÁTICAS DE SEGURANÇA DO EMPREGADOR.

使う機械や溶材のメーカーの指示書をよく読み、まず理解して下さい。そして貴社の安全規定に従って下さい。

請詳細閱讀並理解製造廠提供的說明以及應該使用的銀焊材料，並請遵守貴方的有閣勞動保護規定。

이 제품에 동봉된 작업지침서를 숙지하시고 귀사의 작업자 안전수칙을 준수하시기 바랍니다.

اقرأ بتمعن وأفهم تعليمات المصنع المنتج لهذه المعدات والمواد قبل استعمالها واتبع تعليمات الوقاية لصاحب العمل.



• World's Leader in Welding and Cutting Products •

• Sales and Service through Subsidiaries and Distributors Worldwide •

Cleveland, Ohio 44117-1199 U.S.A. TEL: 216.481.8100 FAX: 216.486.1751 WEB SITE: www.lincolnelectric.com