

**Kwikset**  
THE BEAUTY OF STRENGTH™



# Clear Pack Price Guide

effective May 30, 2006

## BEST

### PREMIUM SECURITY FEATURES

- ANSI Grade 1 Deadbolt Security
- Titanium Alloy Throwbolt Core
- Solid Brass 6-Pin Key Cylinder
- Solid Metal Door Jamb Brace

### ELEGANT ACCENTS AND REFINEMENTS

- Concealed Screws
- Solid Forged Brass

### WARRANTY

- Lifetime Mechanical
- Lifetime Finish



**Kwikset**  
**UltraMax**  
*Signatures*

The Ultimate in  
**Strength** and **Style**.™

## BETTER

### POWERFUL SECURITY FEATURES

- ANSI Grade 2 Deadbolt Security
- Full 1" Solid Core Throwbolt
- Pick Resistant 5-Pin System

### MAXIMUM STYLE AND FINISH

- The Most Popular, Sought-After Designs
- A Wide Array of Finishes

### WARRANTY

- Lifetime Warranty
- 1 Year Electronics Warranty  
on the Kwikset Powerbolt 1000®



**Kwikset**  
**Maximum**  
SECURITY®

Maximum **Security** at  
Maximum **Value**.™

## GOOD

### TRUSTED SECURITY FEATURES

- ANSI Grade 3 Security Features
- Full 1" Solid Core Throwbolt
- Pick Resistant 5-Pin System

### MOST RECOGNIZED STYLE

- Contemporary, Yet Classic And Timeless

### WARRANTY

- Lifetime Mechanical
- 5 Year Finish



**Kwikset**  
**Security**

America's Number One  
Selling **Lockset**.™

## FINISHES

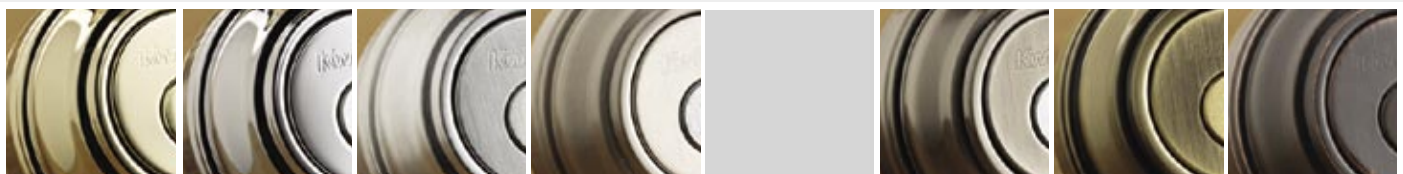

LO3/3 Polished Brass 26 Polished Chrome 26D Satin Chrome 15 Satin Nickel 502 Rustic Pewter 15A Antique Nickel 5 Antique Brass 11P Venetian Bronze

The Ultimate in Strength and Style.™

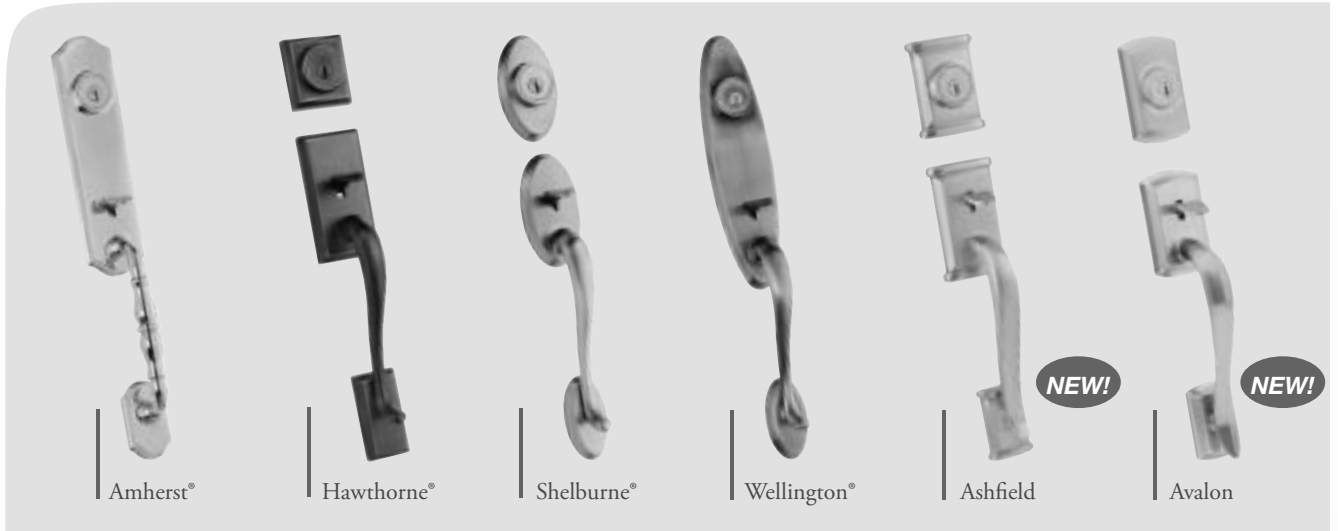

Maximum Security at Maximum Value.™

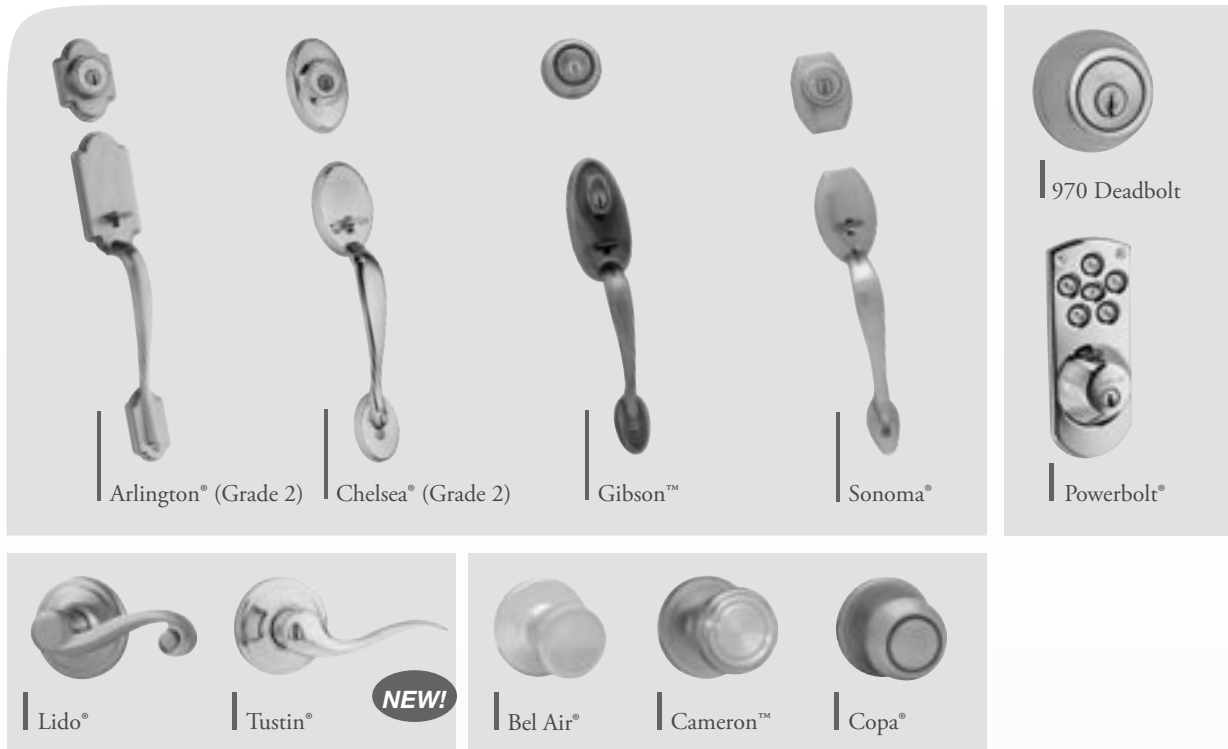

America's Number One Selling Lockset.™



# Table of Contents

	<p>General Information.....4          Ordering Information .....6</p>
	<p>■ Kwikset UltraMax® Signatures ..... 10          Packaging Specifications ..... 10          Handlesets ..... 12          Levers ..... 13          Knobs ..... 14          Combo Packs..... 15          Deadbolts ..... 16</p>
	<p>■ Kwikset Maximum Security® ..... 17          Packaging Specifications ..... 18          Handlesets ..... 20          Levers ..... 21          Knobs ..... 23          Deadbolts ..... 25          Combo Packs..... 26</p>
	<p>■ Kwikset Security® ..... 27          Packaging Specifications ..... 28          Handlesets ..... 30          Knobs ..... 30          Levers ..... 34          Deadbolts ..... 36          Combo Packs..... 38          Project Packs ..... 40</p>
	<p>■ Parts &amp; Accessories ..... 41          Latches..... 42          Rekeying Kit ..... 43          138 Installation &amp; Replacement Parts ..... 44          Pocket Door Hardware..... 45          Trims ..... 46          Kwikset Closers..... 47</p>

## **TERMS AND CONDITIONS OF SALE**

Standard terms are 2% prompt payment discount for payment within 25 days from date of invoice; net 30 days from the date of invoice. Kwikset® reserves the right to charge and recover on invoices which are not paid within the above terms, a service charge of 1-1/2% a month for each month or fraction thereof during which the invoice remains unpaid, said service charge, however, not to exceed the highest applicable legal rate of interest. All orders, whether solicited or written by our sales representatives or forwarded by our customers are deemed to be mere offers to purchase in accordance with these Terms and Conditions of Sale until actually accepted by us at our home office in Lake Forest, CA. We reserve the right to refuse any order as well as the right to sell or not sell to any firm at our sole discretion. The acceptance of an order is expressly made conditional upon your assent to these Terms and Conditions of Sale. We object to the inclusion of any different or additional terms or conditions, even if the same are included in your order, a contract of sale will result upon the Terms and Conditions of Sale stated herein only.

All sales are final.

## **PRICES**

Pricing based on full-case quantities only; orders for less than full case will be automatically adjusted up to the next full-case quantity. All prices are subject to change without notice and are not guaranteed. All taxes, duties or other charges are the responsibility of the customer.

## **CLAIMS**

Price claims must be submitted in writing to Kwikset, 19701 DaVinci, Lake Forest, CA 92610 within 30 days from the date of invoice.

## **CHANGES OR CANCELLATIONS**

Beyond 5 working days of our acknowledgment date no changes can be made. Additions to an order will be handled as a separate order and must meet applicable minimum order requirements. Order cancellation on regular stock items only, or any portion thereof is allowed only upon prior written consent from Kwikset, and the payment of cancellation charges deemed appropriate.

## **MINIMUM CHARGE**

No order will be invoiced for less than \$100.00 net plus shipping charges except for lock accessory parts.

## **MINIMUM ANNUAL SALES VOLUME**

The company reserves the right to discontinue direct sales to any customer who does not meet the minimum annual sales volume requirement. The current annual requirement is \$50,000.00. Your annual purchases are determined by accepted, non-cancelled, and shipped orders received during each calendar year. Kwikset reserves the right to change any or all minimum annual sales volume requirements at any time. Any customer who does not meet the annual

sales volume requirements may continue to purchase Kwikset products through a Kwikset distributor.

## **RETURNS**

Defective merchandise returned to our factories requires prior written authorization from a Kwikset Sales Rep or the Sales Office. A factory return authorization must accompany the returned shipment. The return authorization must include an itemized listing of the merchandise and an explanation stating the reason for return.

There will be a 20% product restocking fee on all returned merchandise.

## **FREIGHT**

All goods are invoiced FOB our factory. Upon delivery of shipments to the carrier, title to, and the risk of loss or damage in transit for such shipments, passes to our customer. Kwikset's standard policy is to pay freight charges on all shipments of 300 locks (Accessories: 300 lbs.) to a single destination in the continental U.S., by carrier and route of our choice. Shipments less than these quantities will not be shipped on a prepaid basis.

If higher freight charges are incurred from customers specifying a carrier or route of their choice the additional cost will be added to that customer's invoice.

## **DELIVERY CONDITIONS**

Shipping schedules are our best estimates, and cannot be guaranteed. Kwikset is not responsible for any direct or consequential loss or damage resulting from an inability or delay in meeting shipping schedules.

## PRODUCT WARRANTY

Warranties cover the original residential user of Kwikset Products against defects in material and workmanship as long as the original user occupies the residential premises upon which the Product was originally installed. This warranty DOES NOT COVER abused or misused products or non-commercial products used in commercial applications. Upon return of a defective Product to Kwikset Corporation, Kwikset shall either replace the Product or refund the purchase price, at our discretion. If a covered defect occurs, call 1-800-327-LOCK (5625) in the U.S. and Canada or return it to Kwikset Corporation, Consumer Services, 19701 DaVinci, Lake Forest, California 92610. A finish deterioration occurring from the use of paints, solvents, or other chemicals is not a defect in the finish and is not covered by this warranty. Kwikset is not liable for incidental or consequential damages. Some states do not allow the exclusion or limitation of incidental or consequential damages, so the above exclusion may not apply to you. This warranty gives you specific legal rights and you may also have other rights that vary from state to state.

## PATENT INDEMNITY

We agree to defend any suit or proceeding brought against our customer so far as based on claim that our products, or any part thereof, made solely to our specifications and furnished to our customer constitute an infringement of any U.S. patent, if notified promptly in writing and given authority, information and assistance at our expense for the defense of same, and we shall pay all damages and costs awarded therein against our customer. In case our products, or any part thereof, is in such suit held to constitute infringement and

their use is enjoined, we will, at our expense and discretion, either procure for our customer the right to continue using the products or replace same with non-infringing products, or modify them so they become non-infringing, or remove such products and refund the purchase price (less depreciation, prorated from the purchase date). The foregoing states our entire liability for patent infringement by our products or any part thereof.

## STANDARDS

Kwikset meets or exceeds the testing requirements specified for each product grade or rating.

- American National Standards Institute (ANSI)
- Builders Hardware Manufacturers Association (BHMA)
- Underwriters Laboratories, Inc. (UL)
- ADA (Americans with Disabilities Act)

## MISCELLANEOUS

Substitution of non-Kwikset components/parts, and any alteration or modification of factory parts, and other lock manufacturer's parts may result in door hardware which does not function properly or will fail and will void all warranties.

Kwikset reserves the right to revise or modify products, product information, or pricing without notice. Product specifications and pricing reflect available information at the time of printing. Kwikset is not responsible for typographic or printing errors.



**ORDER CODE BREAKOUT**

<b>LEVERS</b>													
MFG Pro#	Function	Finish								Case Qty.	Code	Keying	Price
Commonwealth® Lever		L03	3	5	11P	15	15A	26	26D	Case Qty.	Code	Keying	Price
97402-372	740CHL LH - Entry	•								6	•	K6	\$70.20
97200-551	720CHL - Hall/Closet		•							6			\$37.40

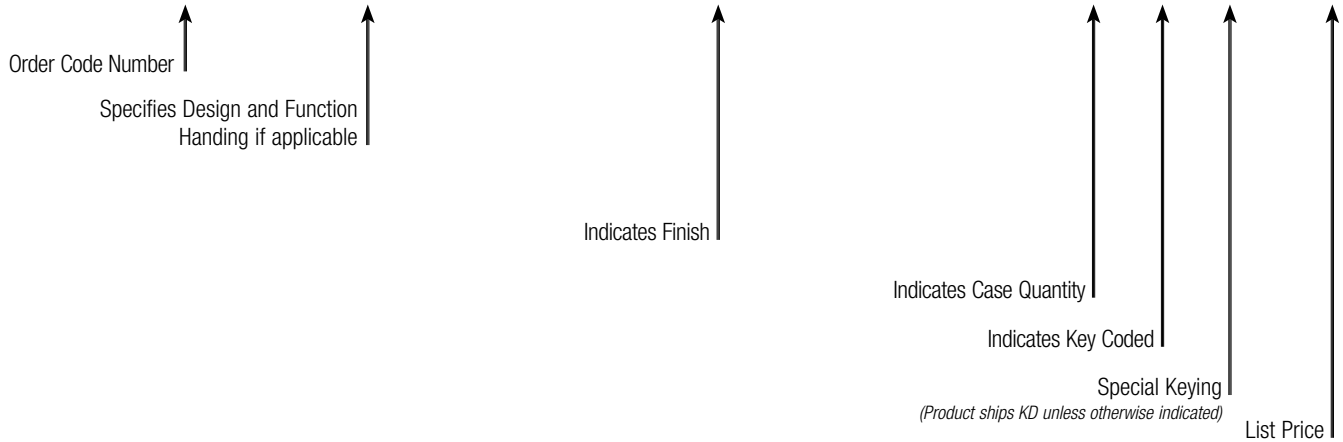

**HANDING**

To determine the handing of a door, face the **OUTSIDE** of a door. If the hinge is on the left side of the door, the door is left-handed (LH). If the hinge is on the right side of the door, the door is right-handed (RH).

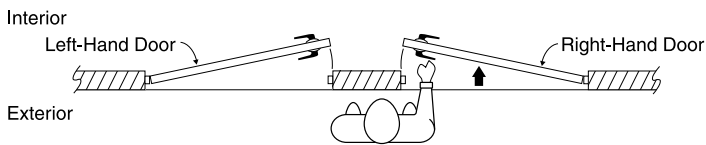

**FINISHES**

US	Description	BHMA
L03	Lifetime Polished Brass	605E
3	Polished Brass	605
5	Antique Brass	609
11P	Tuscan Bronze (Venetian Bronze)	
15	Satin Nickel	619
15A	Antique Nickel	620
26	Polished Chrome	625
26D	Satin Chrome	626
502	Rustic Pewter	



## KEYING

Code	Option
KD	Keyed Different
K2, K4, K6	Keyed Alike (2 Locksets, 4 Locksets, 6 Locksets)

## BACKSET

Backset is the length from center edge of door to center of the 2<sup>1</sup>/<sub>8</sub>" (54mm) diameter hole. 2<sup>3</sup>/<sub>8</sub>" or 2<sup>3</sup>/<sub>4</sub>" in most cases.

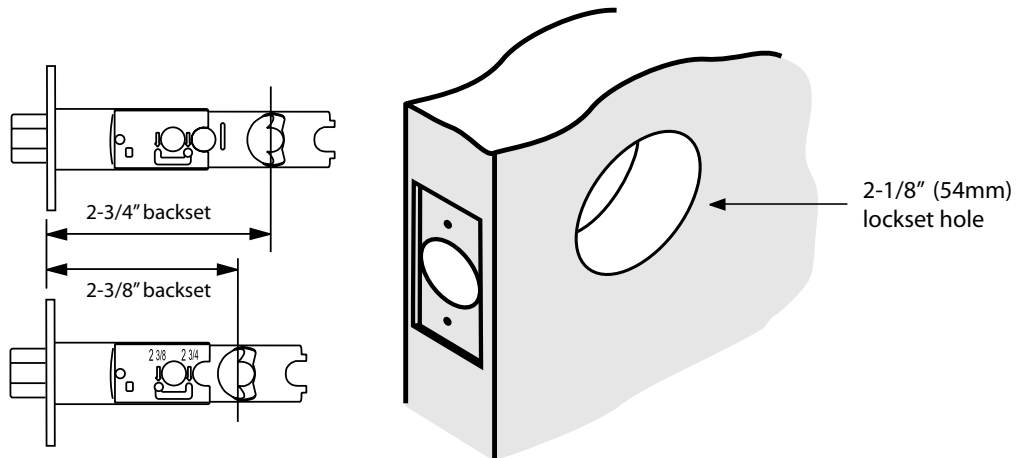

## FUNCTIONS

Model	Description
200/720	Passage/Hall & Closet
300/730	Privacy/Bed & Bath
400/740	Entry
405/740	Keyed Entry Lever
450	Vestibule / Classroom
488/788	Half Dummy Trim, Surface Mounted
510/533/687/800	Single Cylinder Handlesets
511/554/689/801	Double Cylinder Handlesets
512/555/802	Dummy Handlesets

# Ordering Information



## LATCHES

### KNOBBS, LEVERS AND COMBO PACKS

**Kwikset**  
**UltraMax**  
*Signatures*

**Kwikset**  
**Maximum**  
SECURITY®

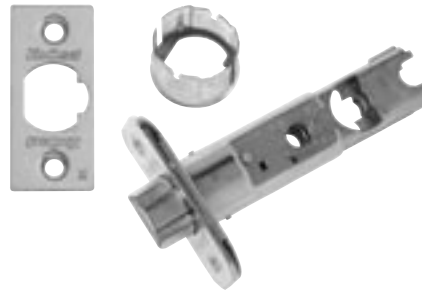

6-Way Adjustable  
fixed round, drive-in  
collar & square plate  
loose in package.

### KNOBBS AND COMBO PACKS

**Kwikset**  
**Security**



4-Way Adjustable  
fixed round drive-in  
collar loose in package.

### ALL HANDLESETS

**Kwikset**  
**UltraMax**  
*Signatures*

**Kwikset**  
**Maximum**  
SECURITY®

**Kwikset**  
**Security**



2-Way Adjustable,  
fixed round corner.

# Kwikset UltraMax® *Signatures*

## PREMIUM SECURITY FEATURES

- ANSI Grade 1 Deadbolt Security
- Titanium Alloy Throwbolt Core
- Solid Brass 6-Pin Key Cylinder
- Solid Metal Door Jamb Brace

## ELEGANT ACCENTS AND REFINEMENTS

- Concealed Screws
- Solid Forged Brass

## WARRANTY

- Lifetime Mechanical
- Lifetime Finish



## HANDLESET FUNCTIONS

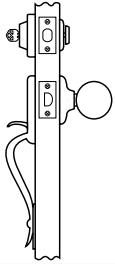

**Model**  
800

### Function

Handle set with Single  
Cylinder Deadbolt

### Description

Latchbolt operated by  
thumbpiece outside and  
grip inside. Deadbolt  
operated by key outside  
and thumbturn inside.

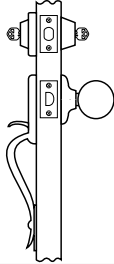

801

Handle set with Double  
Cylinder Deadbolt

Latchbolt operated by  
thumbpiece outside and  
grip inside. Deadbolt  
operated by key both sides.

## KNOB & LEVER FUNCTIONS

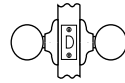

**Passage/Hall/Closet:** Both knobs  
always free.  
**720 F75**

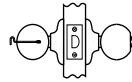

**Privacy/Bed/Bath:** Both knobs locked  
or unlocked by turnbutton inside. Outside  
knob unlocked by emergency key.  
**730 F76**

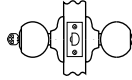

**Entry:** Both knobs locked or unlocked by  
key outside or turnbutton inside.  
**740 F82**



**Half Dummy Trim, Surface Mounted:** For  
doors where only a pull is required. No  
operation.  
**788**

## DEADBOLT FUNCTIONS



**Single Cylinder:** Deadbolt  
operated by key outside and  
thumbturn inside.  
**980S, E0151**



**Double Cylinder:** Deadbolt  
operated by key both sides.  
**985S E0141**

*Note: ANSI/BHMA functions are listed in italics.*

## Kwikset UltraMax<sup>®</sup> Signatures Packaging Dimensions

	Unit Carton Height	Unit Carton Width	Unit Carton Depth	Unit Carton Weight	Master Carton Height	Master Carton Width	Master Carton Depth	Cubic Ft.	Master Carton Weight	Case Count
Knobs	10.250	5.750	3.000	1.9	11.000	6.625	19.750	0.83	11.10	6
Levers	10.500	7.500	3.000	2.6	11.000	8.625	19.875	1.09	10.28	4
Deadbolts	10.500	5.875	3.000	2.5	11.000	6.625	12.500	0.53	9.80	4
Deadbolts	10.500	5.875	3.000	2.5	11.000	6.625	19.750	0.83	14.70	6
Knob Combo Packs	10.250	10.395	3.063	4.7	11.000	11.000	19.750	1.38	28.32	6
Lever Combo Packs	10.250	10.395	3.063	4.7	11.000	11.000	19.750	1.38	18.88	4
Handlesets	21.750	8.000	5.500	10.3	12.500	9.000	22.250	1.45	20.58	2
Inactive Knobs	8.750	3.500	3.250	0.3	9.313	13.313	4.375	0.31	1.32	4
Inactive Levers	8.750	3.500	3.125	0.7	9.313	13.313	4.375	0.31	3.0	4

*Note: All dimensions in inches. All weights in pounds and based on maximum weights of each function.*

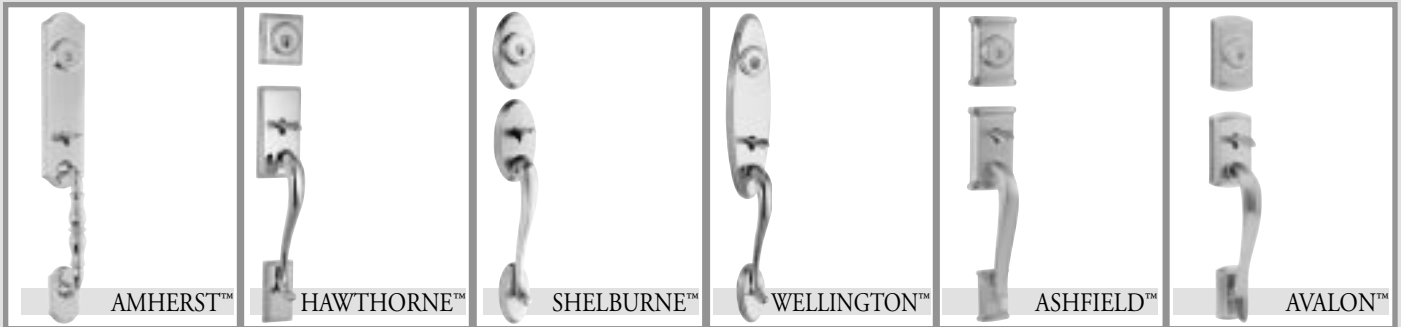

<b>HANDLESETS</b>												
<i>MFG Pro#</i>	<i>Function</i>	<i>Finish</i>								<i>Case Qty.</i>	<i>Price</i>	
<b>Amherst™ Handleset</b>		L03	3	5	11P	15	15A	26	26D			
98000-999	800ATXCHL - Amherst X Commonwealth	•									2	\$263.00
98001-003	800ATXL - Amherst X Laurel				•						2	\$276.00
98001-001	800ATXL - Amherst X Laurel					•					2	\$263.00
<b>Hawthorne™ Handleset</b>		L03	3	5	11P	15	15A	26	26D		<i>Case Qty.</i>	<i>Price</i>
98000-996	800HEXH - Hawthorne X Hancock				•						2	\$237.00
98001-007	800HEXL - Hawthorne X Laurel				•						2	\$243.00
98001-004	800HEXH - Hawthorne X Hancock							•			2	\$226.00
<b>Shelburne™ Handleset</b>		L03	3	5	11P	15	15A	26	26D		<i>Case Qty.</i>	<i>Price</i>
98000-992	800SEXH - Shelburne X Hancock	•									2	\$226.00
98010-072	801SEXH - Shelburne X Hancock	•									2	\$243.00
98000-993	800SEXCHL - Shelburne X Commonwealth			•							2	\$230.00
98001-006	800SEXH - Shelburne X Hancock				•						2	\$232.00
98001-005	800SEXCHL - Shelburne X Commonwealth					•					2	\$243.00
98000-994	800SEXH - Shelburne X Hancock					•					2	\$226.00
98001-034	800SEXL - Shelburne X Laurel					•					2	\$232.00
98000-995	800SEXBRL - Shelburne X Brooklane					•					2	\$243.00
<b>Wellington™ Handleset</b>		L03	3	5	11P	15	15A	26	26D		<i>Case Qty.</i>	<i>Price</i>
98000-997	800WNXH - Wellington X Hancock			•							2	\$248.00
98000-998	800WNBRL - Wellington X Brooklane				•						2	\$276.00
98001-002	800WNXH - Wellington X Hancock						•				2	\$259.00
<b>Ashfield™ Handleset</b>		L03	3	5	11P	15	15A	26	26D	502	<i>Case Qty.</i>	<i>Price</i>
98001-052	800ADHXADL 11P CP				•						2	\$259.00
98001-047	800ADHXADL 502 CP									•	2	\$259.00
<b>Avalon™ Handleset</b>		L03	3	5	11P	15	15A	26	26D	502	<i>Case Qty.</i>	<i>Price</i>
98001-046	800AVHXAVL 15 CP					•					2	\$248.00
98001-054	800AVHXAVL 502 CP									•	2	\$254.00



BROOKLANE®



COMMONWEALTH®

**LEVERS**

MFG Pro#	Function	Finish									Case Qty.	Code	Keying	Price
Brooklane® Lever		L03	3	5	11P	15	15A	26	26D	502				
97200-585	720BRL 11P CP				•						4			\$49.70
97300-610	730BRL 11P CP				•						4			\$52.60
97402-452	740BRL 11P CP CODE K4				•						4	•	K4	\$75.70
97880-571	788BRL LH 11P CP				•						4			\$22.50
97880-572	788BRL RH 11P CP				•						4			\$22.50
97200-606	720BRL 15 CP					•					4			\$46.90
97300-631	730BRL 15 CP					•					4			\$49.10
97402-471	740BRL 15 CP CODE K4					•					4	•	K4	\$81.60
97880-600	788BRL LH 15 CP					•					4			\$23.60
97880-601	788BRL RH 15 CP					•					4			\$23.60
Commonwealth® Lever		L03	3	5	11P	15	15A	26	26D		Case Qty.	Code	Keying	Price
97402-451	740CHL L03 CP CODE K4	•									4	•	K4	\$70.20
97200-584	720CHL 3 CP		•								4			\$37.40
97300-609	730CHL 3 CP		•								4			\$39.40
97880-569	788CHL LH 3 CP		•								4			\$18.30
97880-570	788CHL RH 3 CP		•								4			\$18.30
97200-594	720CHL 5 CP			•							4			\$41.90
97300-619	730CHL 5 CP			•							4			\$43.90
97402-460	740CHL 5 CP CODE K4			•							4	•	K4	\$67.90
97880-583	788CHL LH 5 CP			•							4			\$19.20
97880-584	788CHL RH 5 CP			•							4			\$19.20
97200-607	720CHL 15 CP					•					4			\$44.10
97300-632	730CHL 15 CP					•					4			\$46.40
97402-472	740CHL 15 CP CODE K4					•					4	•	K4	\$70.20
97880-602	788CHL LH 15 CP					•					4			\$20.20
97880-603	788CHL RH 15 CP					•					4			\$20.20



ASHFIELD



AVALON

## LEVERS

MFG Pro#	Function	Finish									Case Qty.	Code	Keying	Price
Ashfield Reversible Lever		L03	3	5	11P	15	15A	26	26D		Case Qty.	Code	Keying	Price
97200-596	720ADL 11P CP				•						4			\$49.70
97300-621	730ADL 11P CP				•						4			\$52.60
97402-462	740ADL 11P CP CODE K4				•						4	•	K4	\$81.60
97880-587	788ADL 11P CP				•						4			\$23.60
97200-590	720ADL 502 CP									•	4			\$49.70
97300-615	730ADL 502 CP									•	4			\$52.60
97402-457	740ADL 502 CP CODE K4									•	4	•	K4	\$81.60
97880-580	788ADL 502 CP									•	4			\$23.60
Avalon Reversible Lever		L03	3	5	11P	15	15A	26	26D		Case Qty.	Code	Keying	Price
97200-589	720AVL 15 CP					•					4			\$46.90
97300-614	730AVL 15 CP					•					4			\$49.10
97402-456	740AVL 15 CP CODE K4					•					4	•	K4	\$75.70
97880-578	788AVL LH 15 CP					•					4			\$22.50
97880-579	788AVL RH 15 CP					•					4			\$22.50
97200-599	720AVL 502 CP									•	4			\$49.70
97300-624	730AVL 502 CP									•	4			\$52.60
97402-464	740AVL 502 CP CODE K4									•	4	•	K4	\$81.60
97880-589	788AVL LH 502 CP									•	4			\$23.60
97880-590	788AVL RH 502 CP									•	4			\$23.60



HANCOCK®

**KNOBS**

MFG Pro#	Function	Finish								Case Qty.	Code	Keying	Price
		L03	3	5	11P	15	15A	26	26D				
<b>Hancock® Knob</b>													
97402-378	740H - Entry	•								6	•	K6	\$48.30
97402-416	740H - Entry	•								6		K2	\$48.30
97200-555	720H - Hall/Closet		•							6			\$25.50
97300-581	730H - Bed/Bath		•							6			\$27.80
97880-340	788H - Inactive		•							4			\$11.40
97200-556	720H - Hall/Closet			•						6			\$26.80
97300-574	730H - Bed/Bath			•						6			\$29.20
97402-377	740H - Entry			•						6	•	K6	\$45.90
97880-341	788H - Inactive			•						4			\$12.00
97200-553	720H - Hall/Closet				•					6			\$32.00
97300-579	730H - Bed/Bath				•					6			\$35.30
97402-375	740H - Entry				•					6	•	K6	\$54.10
97880-338	788H - Inactive				•					4			\$14.50
97200-554	720H - Hall/Closet					•				6			\$28.10
97300-580	730H - Bed/Bath					•				6			\$30.70
97402-376	740H - Entry					•				6	•	K6	\$48.30
97402-417	740H - Entry					•				6		K2	\$48.30
97880-339	788H - Inactive					•				4			\$12.60
97200-562	720H - Hall/Closet						•			6			\$28.10
97300-587	730H - Bed/Bath						•			6			\$30.70
97402-402	740H - Entry						•			6	•	K6	\$48.30
97402-418	740H - Entry						•			6		K2	\$48.30
97880-346	788H - Inactive						•			4			\$12.60
97200-563	720H - Hall/Closet							•		6			\$28.10
97300-588	730H - Bed/Bath							•		6			\$30.70
97402-403	740H - Entry							•		6	•	K6	\$48.30
97880-347	788H - Inactive							•		4			\$12.60
97200-568	720H - Hall/Closet								•	6			
97300-593	730H - Bed/Bath								•	6			
97402-419	740H - Entry								•	6		K2	\$48.30
97880-533	788H - Inactive								•	4			\$12.60





LAUREL®

## KNOBS

MFG Pro#	Function	Finish									Case Qty.	Code	Keying	Price
		L03	3	5	11P	15	15A	26	26D	502				
<b>Laurel® Knob</b>														
97402-420	740L - Entry	•									6		K2	
97200-569	720L - Hall/Closet		•								6			
97300-594	730L - Bed/Bath		•								6			
97880-563	788L - Inactive		•								4			\$18.30
97200-561	720L - Hall/Closet				•						6			\$46.10
97300-586	730L - Bed/Bath				•						6			\$48.50
97402-401	740L - Entry				•						6	•	K6	\$78.30
97880-542	788L - Inactive				•						4			\$22.60
97200-557	720L - Hall/Closet					•					6			\$41.20
97300-582	730L - Bed/Bath					•					6			\$43.40
97402-379	740L - Entry					•					6	•	K6	\$70.20
97880-541	788L - Inactive					•					4			\$20.20



HANCOCK®  
COMBO PACK



COMMONWEALTH®  
COMBO PACK



ASHFIELD®  
COMBO PACK



AVALON®  
COMBO PACK

## COMBO PACKS

### COMMONWEALTH® COMBO PACK

MFG Pro#	Function	Finish										Case Qty.	Code	Keying	Price
		L03	3	5	11P	15	15A	26	26D	502					
<b>991 Combo Pack*</b>															
99910-027	991CHL L03 CP CODE K4	•									4	•	K4	\$63.00	
99910-023	991H L03 CP CODE K6	•									6	•	K6	\$98.90	
99910-026	991CHL 5 CP CODE K4		•								4	•	K4	\$63.00	
99910-016	991H 5 CP CODE K6		•								6	•	K6	\$94.00	
99910-028	991BRL 11P CP CODE K4				•						4	•	K4	\$63.00	
99910-018	991H 11P CP CODE K6				•						6	•	K6	\$104.00	
99910-025	991AVL 15 CP CODE K4					•					4	•	K4	\$113.90	
99910-017	991H 15 CP CODE K6					•					6	•	K6	\$98.90	
99910-029	991ADL 502 CP CODE K4									•	4	•	K4	\$113.90	
<b>992 Combo Pack†</b>															
99920-004	992H L03 CODE CP K6	•									6	•	K6	\$119.80	

\*Hancock Knob with Double Cylinder Deadbolt.

†Hancock Knob with Double Cylinder Deadbolt.



980S DEADBOLT



985S DEADBOLT

**DEADBOLTS**

MFG Pro#	Function	Finish									Case Qty.	Code	Keying	Price
		L03	3	5	11P	15	15A	26	26D	502				
<b>Single Cylinder Deadbolt</b>		L03	3	5	11P	15	15A	26	26D	502				
99800-049	980S - Single Cylinder	•									6	•	K6	\$53.80
99800-056	980S - Single Cylinder	•									6		K2	\$53.80
99800-050	980S - Single Cylinder			•							6	•	K6	\$51.00
99800-057	980S - Single Cylinder			•							6		K2	\$51.00
99800-052	980S - Single Cylinder				•						6	•	K6	\$56.50
99800-051	980S - Single Cylinder					•					6	•	K6	\$53.80
99800-054	980S - Single Cylinder						•				6	•	K6	\$53.80
99800-055	980S - Single Cylinder							•			6	•	K6	\$53.80
99800-058	980S - Single Cylinder								•		6		K2	\$53.80
99800-076	980S - Single Cylinder									•	4	•	K2	\$56.50
<b>Double Cylinder Deadbolt</b>		L03	3	5	11P	15	15A	26	26D		Case Qty.	Code	Keying	Price
99850-035	985S - Double Cylinder	•									6	•	K6	\$75.30
99850-036	985S - Double Cylinder			•							6	•	K6	\$71.50
99850-038	985S - Double Cylinder				•						6	•	K6	\$79.00
99850-037	985S - Double Cylinder					•					6	•	K6	\$75.30
99850-039	985S - Double Cylinder						•				6	•	K6	\$75.30
99850-040	985S - Double Cylinder							•			6	•	K6	\$75.30
99850-041	985S - Double Cylinder								•		6		K2	\$75.30

# **Kwikset** **Maximum** SECURITY®

## POWERFUL SECURITY FEATURES

- ANSI Grade 2 Deadbolt Security
- Full 1" Solid Core Throwbolt
- Pick Resistant 5-Pin System

## MAXIMUM STYLE AND FINISH

- The Most Popular, Sought-After Designs
- A Wide Array of Finishes

## WARRANTY



- Lifetime Warranty
- 1 Year Electronics Warranty  
on the Kwikset Powerbolt 1000®



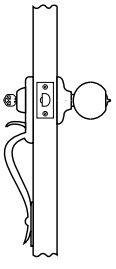
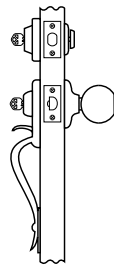
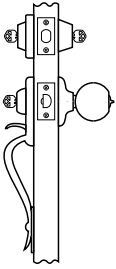
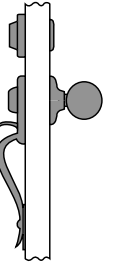

## HANDLESET FUNCTIONS

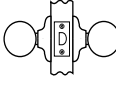
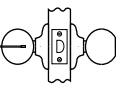
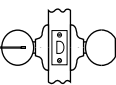
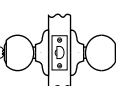
			
<b>Model</b> 552	553 510	554 511	555 512
<b>Function</b> One Piece Handleset	One Piece Handleset with Single Cylinder Deadbolt	One Piece Handleset with Double Cylinder Deadbolt	One Piece Dummy Handleset with Dummy Deadbolt
<b>Description</b> Latchbolt operated by thumbpiece outside and grip inside, except when both are locked by key outside or turnbutton inside.	Latchbolt operated by thumbpiece outside and grip inside, except when both are locked by key outside or turnbutton inside. Deadbolt operated by key outside or thumbturn inside.	Latchbolt operated by thumbpiece outside and grip inside, except when both are locked by key outside or turnbutton inside. Deadbolt operated by key both sides.	Handle and grip act as a pull only. For inactive leaf on double doors. No operation.

## KNOB & LEVER FUNCTIONS

	<b>Passage/Hall/Closet:</b> Both knobs or levers always free. <b>200 F75</b>
	<b>Privacy/Bed/Bath:</b> Both knobs or levers locked or unlocked by turnbutton inside. Outside knob unlocked by emergency key. <b>300 F76</b>
	<b>Privacy/Bathroom:</b> Same function as 300 above. Inside knob or lever polished chrome. <b>300 F76</b>
	<b>Entry:</b> Both knobs or levers locked or unlocked by key outside or turnbutton inside. <b>400 F82 - 2 knobs or knob &amp; lever</b> <b>405 F82 - 2 levers</b>
	<b>Half Dummy Trim, Surface Mounted:</b> For doors where only a pull is required. No operation. <b>488</b>

## DEADBOLT FUNCTIONS

	<b>Single Cylinder:</b> Deadbolt operated by key outside and thumbturn inside. <b>970 E0153</b>
	<b>Double Cylinder:</b> Deadbolt operated by key both sides. <b>975 E0143</b>

Note: ANSI/BHMA functions are listed in italics.

## Kwikset Maximum Security® Packaging Dimensions

	Unit Carton Height	Unit Carton Width	Unit Carton Depth	Unit Carton Weight	Master Carton Height	Master Carton Width	Master Carton Depth	Cubic Ft.	Master Carton Weight	Case Count
Knobs	10.25	5.875	3	1.7	11	6.625	19.75	.83	9.9	6
Levers	10.25	7.5	3.063	2.1	11	8.625	19.875	1.09	12.78	6
Deadbolts	10.25	5.75	3	2.6	11	6.625	19.75	.83	15.54	6
Knob Combo Packs	10.125	10.375	3	4.4	11	11	19.75	1.38	26.34	6
Lever Combo Packs	10.125	10.375	3	4.4	11	11	19.75	1.38	17.56	4
Handlesets	21.75	8	5.5	8.2	12.5	9	22.25	1.45	16.46	2
Inactive	8.75	3.5	3	.9	9.313	13.313	4.375	.31	3.72	4
Powerbolt®	11.19	6.625	4	2.68	11.625	6.625	8.875	.396	5.75	2

Note: All dimensions in inches. All weights in pounds and based on maximum weights of each function.

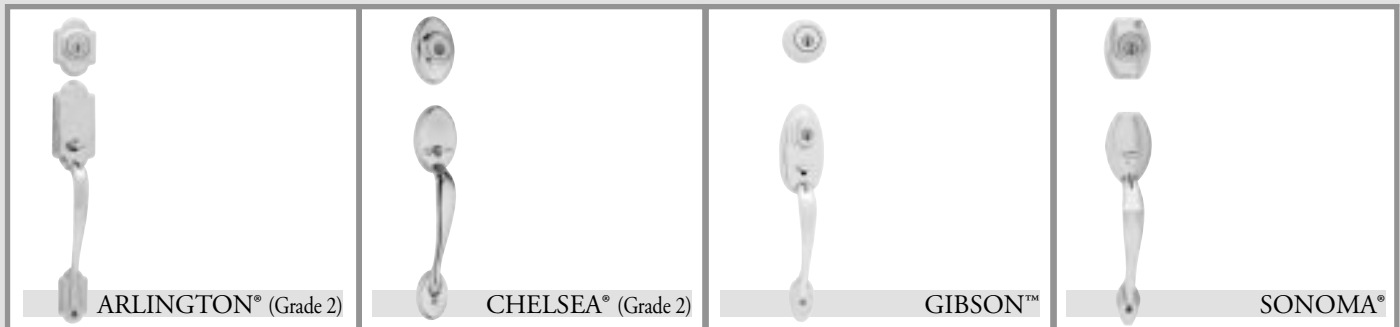

Kwikset Maximum Security®

## HANDLESETS

MFG Pro#	Function	Finish								Case Qty.	Price
		L03	3	5	11P	15	15A	26	26D		
<b>Arlington® (Grade 2) Handleset</b>		L03	3	5	11P	15	15A	26	26D		
95100-044	510ANXLL - Arlington X Lido	•								2	\$170.10
95100-052	510ANXTNL - Arlington X Tustin	•								2	\$170.10
95100-047	510ANXC - Arlington X Copa			•						2	\$140.70
95100-048	510ANXLL - Arlington X Lido			•						2	\$161.70
95100-060	510ANXTNL - Arlington X Tustin				•					2	\$194.30
95100-045	510ANXLL - Arlington X Lido					•				2	\$186.90
95100-053	510ANXTNL - Arlington X Tustin					•				2	\$186.90
<b>Chelsea® (Grade 2) Handleset</b>		L03	3	5	11P	15	15A	26	26D	Case Qty.	Price
95100-037	510CEXC - Chelsea X Cameron	•								2	\$148.10
95100-038	510CEXC - Chelsea X Copa	•								2	\$148.10
95100-043	510CEXLL - Chelsea X Lido Lever	•								2	\$170.10
95100-049	510CEXTNL - Chelsea X Tustin	•								2	\$170.10
95100-042	510CEXC - Chelsea X Copa			•						2	\$140.70
95100-051	510CEXTNL - Chelsea X Tustin			•						2	\$161.70
95100-054	510CEXTNL - Chelsea X Tustin				•					2	\$194.30
95100-040	510CEXC - Chelsea X Cameron					•				2	\$162.80
95100-041	510CEXC - Chelsea X Copa					•				2	\$162.80
95100-050	510CEXTNL - Chelsea X Tustin					•				2	\$186.90
<b>Gibson™ Handleset</b>		L03	3	5	11P	15	15A	26	26D	Case Qty.	Price
95530-007	553GNXC - Gibson X Cameron		•							2	\$198.50
	XXXXX Gibson X Copa		•							2	\$198.50
95530-004	553GNXB - Gibson X Bel Air		•							2	\$198.50
95540-001	554GNXB - Gibson X Bel Air		•							2	\$211.10
95550-001	555GNXB - Gibson X Bel Air		•							2	\$176.40
<b>Sonoma® Handleset</b>		L03	3	5	11P	15	15A	26	26D	Case Qty.	Price
	XXXXX Sonoma X Lido		•							2	\$154.40
	XXXXX Sonoma X Lido					•				2	\$176.40



LIDO®

## LEVERS

MFG Pro#	Function	Finish								Case Qty.	Code	Keying	Price
		L03	3	5	11P	15	15A	26	26D				
<b>Lido® Lever</b>													
92001-265	200LL - Hall/Closet		•										\$32.00
93001-389	300LL - Bed/Bath		•										\$33.90
94050-348	405LL - Keyed Entry		•								•		\$55.70
94050-347	405LL - Keyed Entry		•								•	K4	\$55.70
94880-424	488LL LH - Inactive		•										\$14.50
94880-425	488LL RH - Inactive		•										\$33.90
92001-268	200LL - Hall/Closet			•									\$33.10
93001-492	300LL - Bed/Bath			•									\$33.10
94050-350	405LL - Keyed Entry			•							•	K4	\$56.80
94880-429	488LL LH - Inactive			•									\$15.20
94880-430	488LL RH - Inactive			•									\$33.10
92001-297	200LL - Hall/Closet				•								\$44.10
93001-522	300LL - Bed/Bath				•								\$47.30
94050-360	405LL - Keyed Entry				•						•	K4	\$69.30
94880-440	488LL LH - Inactive				•								\$18.90
94880-441	488LL RH - Inactive				•								\$44.10
92001-264	200LL - Hall/Closet					•							\$36.90
93001-388	300LL - Bed/Bath					•							\$39.10
94050-346	405LL - Keyed Entry					•					•		\$64.10
94050-345	405LL - Keyed Entry					•					•	K4	\$64.10
94880-422	488LL LH - Inactive					•							\$16.60
94880-423	488LL RH - Inactive					•							\$39.10

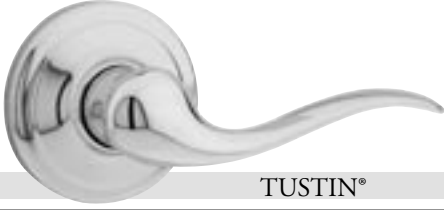

TUSTIN®

Kwikset Maximum Security®

<b>LEVERS</b>													
MFG Pro#	Function	Finish								Case Qty.	Code	Keying	Price
		L03	3	5	11P	15	15A	26	26D				
<b>Tustin® Lever</b>													
92001-261	200TNL - Hall/Closet		•										\$32.00
93001-385	300TNL - Bed/Bath		•										\$33.90
94050-342	405TNL - Keyed Entry		•								•		\$55.70
94050-339	405TNL - Keyed Entry		•								•	K4	\$55.70
94880-414	488TNL LH - Inactive		•										\$14.50
94880-417	488TNL RH - Inactive		•										\$14.50
92001-262	200TNL - Hall/Closet			•									\$33.10
93001-386	300TNL - Bed/Bath			•									\$35.10
94050-343	405TNL - Keyed Entry			•							•		\$56.80
94050-340	405TNL - Keyed Entry			•							•	K4	\$56.80
94880-416	488TNL LH - Inactive			•									\$15.20
94880-419	488TNL RH - Inactive			•									\$15.20
92001-263	200TNL - Hall/Closet				•								\$44.10
93001-387	300TNL - Bed/Bath				•								\$47.30
94050-344	405TNL - Keyed Entry				•						•	K4	\$69.30
94880-420	488TNL LH - Inactive				•								\$18.90
94880-421	488TNL RH - Inactive				•								\$18.90
92001-260	200TNL - Hall/Closet					•							\$36.90
93001-384	300TNL - Bed/Bath					•							\$39.10
94050-341	405TNL - Keyed Entry					•					•		\$64.10
94050-338	405TNL - Keyed Entry					•					•	K4	\$64.10
94880-415	488TNL LH - Inactive					•							\$16.60
94880-418	488TNL RH - Inactive					•							\$16.60
92001-267	200TNL - Hall/Closet							•					\$36.90
93001-491	300TNL - Bed/Bath							•					\$39.10
94050-349	405TNL - Keyed Entry							•			•	K4	\$64.10
94880-427	488TNL LH - Inactive							•					\$16.60
94880-428	488TNL RH - Inactive							•					\$16.60



BEL AIR®



CAMERON™

## KNOBS

MFG Pro#	Function	Finish								Case Qty.	Code	Keying	Price
		L03	3	5	11P	15	15A	26	26D				
<b>Bel Air® Knob</b>		L03	3	5	11P	15	15A	26	26D				
92000-875	200B - Hall/Closet		•							6			\$19.30
93000-978	300B - Bed/Bath		•							6			\$21.30
94002-001	400B - Entry		•							6		K2	\$32.70
94001-999	400B - Entry		•							6			\$32.70
94001-965	400B - Entry		•							6	•	K6	\$32.70
94880-256	488B - Inactive		•							4			\$9.90
<b>Cameron® Knob</b>		L03	3	5	11P	15	15A	26	26D	Case Qty.	Code	Keying	Price
92001-228	200CN - Hall/Closet		•							6			\$19.30
93001-354	300CN - Bed/Bath		•							6			\$21.30
94002-369	400CN - Entry		•							6	•	K6	\$32.70
94002-389	400CN - Entry		•							6	•	K2	\$32.70
94880-354	488CN - Inactive		•							4			\$9.90
92001-240	200CN - Hall/Closet					•				6			\$22.20
93003-033	300CN - Bed/Bath					•				6			\$24.50
94003-089	400CN - Entry					•				6	•	K6	\$37.50
94002-390	400CN - Entry					•				6	•	K2	\$37.50
94880-358	488CN - Inactive					•				4			\$11.20
	300CN - Bathroom							•		6			\$22.60





COPA®

## KNOBS

MFG Pro#	Function	Finish								Case Qty.	Code	Keying	Price
		L03	3	5	11P	15	15A	26	26D				
<b>Copa® Knob</b>													
92000-879	200C - Hall/Closet		•							6			\$19.50
93000-983	300C - Bed/Bath		•							6			\$21.40
94002-004	400C - Entry		•							6		K2	\$32.90
94002-003	400C - Entry		•							6			\$32.90
94001-968	400C - Entry		•							6	•	K6	\$32.90
94880-259	488C - Inactive		•							4			\$9.90
92000-880	200C - Hall/Closet			•						6			\$20.50
93000-985	300C - Bed/Bath			•						6			\$23.50
94002-007	400C - Entry			•						6			\$35.10
94001-969	400C - Entry			•						6	•	K6	\$35.10
94880-260	488C - Inactive			•						4			\$10.40
92000-877	200C - Hall/Closet					•				6			\$22.50
93000-981	300C - Bed/Bath					•				6			\$24.70
94001-967	400C - Entry					•				6	•	K6	\$37.80
94880-258	488C - Inactive					•				4			\$11.30
	300C - Bathroom							•		6			\$22.40



970 DEADBOLT



975 DEADBOLT



POWERBOLT 1000®

## DEADBOLTS

MFG Pro#	Function	Finish								Case Qty.	Code	Keying	Price
		L03	3	5	11P	15	15A	26	26D				
<b>Single Cylinder Deadbolt</b>		L03	3	5	11P	15	15A	26	26D				
99700-010	970 - Single Cylinder		•							6			\$32.70
99700-008	970 - Single Cylinder		•							6	•	K6	\$32.70
99700-011	970 - Single Cylinder		•							6		K2	\$32.70
99700-012	970 - Single Cylinder			•						6			\$34.20
99700-009	970 - Single Cylinder			•						6	•	K6	\$34.20
99700-013	970 - Single Cylinder			•						6		K2	\$34.20
99700-004	970 - Single Cylinder					•				6	•	K6	\$37.50
99700-005	970 - Single Cylinder						•			6	•	K6	\$37.50
99700-006	970 - Single Cylinder							•		6			\$37.50
99700-007	970 - Single Cylinder								•	6	•	K6	\$37.50
<b>Double Cylinder Deadbolt</b>		L03	3	5	11P	15	15A	26	26D	Case Qty.	Code	Keying	Price
99750-011	975 - Double Cylinder		•							6			\$38.10
99750-008	975 - Double Cylinder		•							6	•	K6	\$38.10
99750-010	975 - Double Cylinder		•							6	•	K2	\$38.10
99750-012	975 - Double Cylinder			•						6			\$40.00
99750-013	975 - Double Cylinder			•						6		K2	\$40.00
99750-009	975 - Double Cylinder			•						6	•	K6	\$40.00
99750-004	975 - Double Cylinder					•				6	•	K6	\$43.90
99750-005	975 - Double Cylinder						•			6	•	K6	\$43.90
99750-006	975 - Double Cylinder							•		6	•	K6	\$43.90
99750-007	975 - Double Cylinder								•	6	•	K6	\$43.90
<b>Powerbolt 1000®</b>		L03	3	5	11P	15	15A	26	26D	Case Qty.	Code	Keying	Price
99070-001	907 Powerbolt	•								2			\$180.60
99070-005	907 Powerbolt				•					2			\$198.70
99070-002	907 Powerbolt					•				2			\$180.60



CAMERON™ COMBO PACK



LIDO® LEVER COMBO PACK



TUSTIN® LEVER COMBO PACK

## COMBO PACKS

MFG Pro#	Function	Finish								Case Qty.	Code	Keying	Price
		L03	3	5	11P	15	15A	26	26D				
<b>Single Cylinder Combo Packs</b>													
99900-001	990B - Bel Air Knob with Single Cylinder Deadbolt		•							6	•	K6	\$63.30
99900-002	990C - Copa Knob with Single Cylinder Deadbolt		•							6	•	K6	\$65.10
99900-009	990LL LH - Lido Lever with Single Cylinder Deadbolt		•							6	•	K6	\$85.40
99900-010	990LL RH - Lido Lever with Single Cylinder Deadbolt		•							6	•	K6	\$85.40
99900-026	990LL - Lido Lever with Single Cylinder Deadbolt		•							6	•	K4	\$85.40
99900-022	990CN - Cameron Knob with Single Cylinder Deadbolt		•							6	•	K6	\$63.30
99900-024	990TNL - Tustin Lever with Single Cylinder Deadbolt		•								•	K4	\$85.40
99900-004	990LL LH - Lido Lever with Single Cylinder Deadbolt					•				6	•	K6	\$98.00
99900-006	990LL RH - Lido Lever with Single Cylinder Deadbolt					•				6	•	K6	\$98.00
99900-023	990CN - Cameron Knob with Single Cylinder Deadbolt					•				6	•	K6	\$73.00
99900-027	990LL - Lido Lever with Single Cylinder Deadbolt					•				6	•	K4	\$98.00
99900-025	990TNL - Tustin Lever with Single Cylinder Deadbolt					•					•	K4	\$98.00
<b>Double Cylinder Combo Packs</b>													
99950-001	995B - Bel Air Knob with Double Cylinder Deadbolt		•							6	•	K6	\$68.70
99950-008	995CN - Cameron Knob with Double Cylinder Deadbolt		•							6	•	K6	\$68.70
99950-002	995C - Copa Knob with Double Cylinder Deadbolt		•							6	•	K6	\$70.50
99950-003	995LL LH - Lido Lever with Double Cylinder Deadbolt		•							6	•	K6	\$90.70
99950-004	995LL RH - Lido Lever with Double Cylinder Deadbolt		•							6	•	K6	\$90.70
99900-024	990TNL - Tustin Lever with Single Cylinder Deadbolt		•							6	•	K4	\$85.40
99900-025	990TNL - Tustin Lever with Single Cylinder Deadbolt					•				6	•	K4	\$98.00

# Kwikset Security®

## TRUSTED SECURITY FEATURES



- ANSI Grade 3 Security Features
- Full 1" Solid Core Throwbolt
- Pick Resistant 5-Pin System

## MOST RECOGNIZED STYLE

- Contemporary, Yet Classic and Timeless

## WARRANTY



- Lifetime Mechanical
- 5 Year Finish



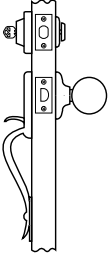
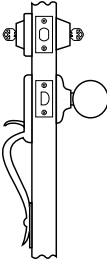
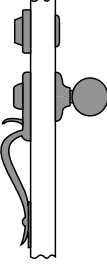

## HANDLESET FUNCTIONS

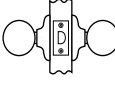
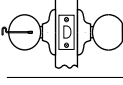
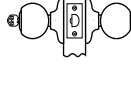
		
<b>Model</b> 687 Dakota 687 Farmington	689 Dakota 689 Farmington	699 Dakota 699 Farmington
<b>Function</b> Sectional Handleset with Single Cylinder Deadbolt	Sectional Handleset with Double Cylinder Deadbolt	Sectional Dummy Handleset with Dummy Deadbolt
<b>Description</b> Latchbolt operated by thumbpiece outside and grip inside. Deadbolt operated by key outside and thumbturn inside.	Latchbolt operated by thumbpiece outside and grip inside. Deadbolt operated by key both sides.	Handle and grip act as a pull only. For inactive leaf on double doors. No operation.

## KNOB & LEVER FUNCTIONS

	<b>Passage/Hall/Closet:</b> Both knobs always free. <b>200 F75</b>
	<b>Privacy/Bathroom:</b> Same function as 300 above. Inside knob polished chrome. <b>300 F76</b>
	<b>Entry:</b> Both knobs or levers locked or unlocked by key outside or thumbturn inside. <b>400 F82 - 2 knobs or knob &amp; lever</b> <b>405 F82 - 2 levers</b>
	<b>Half Dummy Trim, Surface Mounted:</b> For doors where only a pull is required. No operation. <b>488</b>

## DEADBOLT FUNCTIONS

	<b>Single Cylinder:</b> Deadbolt operated by key outside and thumbturn inside. <b>660/660M</b>
	<b>Double Cylinder:</b> Deadbolt operated by key both sides. <b>665</b>
	<b>Thumbturn Only:</b> Deadbolt operated by thumbturn one side. No trim on other side. <b>663</b>

Note: ANSI/BHMA functions are listed in italics.

## Kwikset Security® Packaging Dimensions

	Unit Carton Height	Unit Carton Width	Unit Carton Depth	Unit Carton Weight	Master Carton Height	Master Carton Width	Master Carton Depth	Cubic Ft.	Master Carton Weight	Case Count
Knobs	6.5	8	3	1.4	6.875	17.187	8.5	0.581	8.4	6
Levers	6.5	8	3	2.13	6.875	17.187	8.5	0.581	12.78	6
Deadbolts	6.5	2.906	5.375	1.235	6.688	17.438	6.25	0.422	7.41	6
Combo Packs	10.5	7.875	3.25	2.5	11.4	8.875	18.125	1.061	15	6
Farmington	21	8.125	5.5	4.5	12.5	9	21.625	1.408	9	2
Dakota	21	8.125	5.5	6	12.5	9	21.625	1.408	12	2
Dummy Knobs	8.75	3.5	3.125	0.93	9.313	13.313	4.375	0.314	3.72	4
244, 243	10.5	7.75	3	2.5	11.4	8.875	18.125	1.061	15	6
242	11.125	12.75	2.875	5	13.063	18.75	13.813	1.958	30	6
Inactive Levers	8.75	3	3.5	0.93	9.313	13.313	4.375	0.314	3.72	4

Note: All dimensions in inches. All weights in pounds and based on maximum weights of each function.



DAKOTA™



FARMINGTON®

## HANDLESETS

MFG Pro#	Function	Finish								Case Qty.	Price
		L03	3	5	11P	15	15A	26	26D		
<b>Dakota™ Handleset</b>		L03	3	5	11P	15	15A	26	26D		
96870-024	687DAXP - Dakota X Polo		•							2	\$112.20
96870-048	687DAXT - Dakota X Tylo		•							2	\$112.20
96870-025	687DAXT - Dakota X Tylo			•						2	\$122.40
96870-047	687DAXP - Dakota X Polo					•				2	\$122.40
96870-050	687DAXT - Dakota X Tylo								•	2	\$117.30
<b>Farmington® Handleset</b>		L03	3	5	11P	15	15A	26	26D	Case Qty.	Price
96870-026	687FN X T - Farmington X Tylo			•						2	\$88.70



POLO®

## KNOBS

MFG Pro#	Function	Finish										Case Qty.	Code	Keying	Price
		L03	3	5	11P	15	15A	26	26D	3x26					
<b>Polo® Knob</b>		L03	3	5	11P	15	15A	26	26D	3x26					
92001-276	200P - Hall/Closet		•								6			\$15.90	
93001-500	300P - Bed/Bath		•								6			\$17.60	
94002-431	400P - Entry		•								6			\$23.40	
94002-433	400P - Entry		•								6		K2	\$23.40	
94002-432	400P - Entry		•								6	•	K6	\$23.40	
94500-077	450P - Vestibule/Storeroom		•								6		K2	\$25.60	
94880-367	488P - Inactive		•								4			\$7.20	
94002-433	400P - Entry		•								6		K2	\$23.40	

# America's Number One Selling Lockset.™



POLO® (Continued)

<b>KNOBS</b>														
<i>MFG Pro#</i>	<i>Function</i>	<i>Finish</i>									<i>Case Qty.</i>	<i>Code</i>	<i>Keying</i>	<i>Price</i>
<b>Polo® Knob Continued</b>		L03	3	5	11P	15	15A	26	26D	3x26				
92001-277	200P - Hall/Closet			•							6		\$17.90	
93001-501	300P - Bed/Bath			•							6		\$19.50	
94002-434	400P - Entry			•							6		\$25.00	
94002-436	400P - Entry			•							6	K2	\$25.00	
94002-435	400P - Entry			•							6	• K6	\$25.00	
94880-368	488P- Inactive			•							4		\$8.00	
92001-272	200P - Hall/Closet				•						6		\$17.90	
93001-496	300P - Bed/Bath				•						6		\$19.50	
94002-421	400P - Entry				•						6	K2	\$25.00	
94880-399	488P- Inactive				•						4		\$8.80	
92001-273	200P - Hall/Closet					•					6		\$17.90	
93001-497	300P - Bed/Bath					•					6		\$19.50	
94002-422	400P - Entry					•					6		\$25.00	
94002-424	400P - Entry					•					6	K2	\$25.00	
94002-423	400P - Entry					•					6	• K6	\$25.00	
94880-370	488P- Inactive					•					4		\$8.00	
92001-274	200P - Hall/Closet						•				6		\$17.90	
93001-498	300P - Bed/Bath						•				6		\$19.50	
94002-425	400P - Entry						•				6		\$25.00	
94002-427	400P - Entry						•				6	K2	\$25.00	
94002-426	400P - Entry						•				6	• K6	\$25.00	
94880-371	488P- Inactive						•				4		\$8.00	
92001-275	200P - Hall/Closet							•			6		\$16.20	
93001-499	300P - Bed/Bath							•			6		\$18.00	
94002-428	400P - Entry							•			6		\$23.80	
94002-430	400P - Entry							•			6	K2	\$23.80	
94002-429	400P - Entry							•			6	• K6	\$23.80	
94880-369	488P- Inactive							•			4		\$7.40	
94500-076	450P - Vestibule/Storeroom							•			6	K2	\$26.40	



TYLO®

## KNOBS

MFG Pro#	Function	Finish									Case Qty.	Code	Keying	Price
		L03	3	5	11P	15	15A	26	26D	3x26				
Tylo® Knob														
92001-280	200T - Hall/Closet		•								6			\$14.00
93001-504	300T - Bed/Bath		•								6			\$15.50
94002-443	400T - Entry		•								6			\$21.20
94002-445	400T - Entry		•								6		K2	\$21.20
94002-444	400T - Entry		•								6	•	K6	\$21.20
94880-363	488T - Inactive		•								4			\$6.40
92001-281	200T - Hall/Closet			•							6			\$15.60
93001-506	300T - Bed/Bath			•							6			\$17.00
94002-446	400T - Entry			•							6			\$22.70
94002-448	400T - Entry			•							6		K2	\$22.70
94002-447	400T - Entry			•							6	•	K6	\$22.70
94880-364	488T - Inactive			•							4			\$7.40
92001-278	200T - Hall/Closet							•			6			\$15.60
93001-502	300T - Bed/Bath							•			6			\$17.00
94002-437	400T - Entry							•			6			\$22.70
94002-439	400T - Entry							•			6		K2	\$22.70
94002-438	400T - Entry							•			6	•	K6	\$22.70
94880-366	488T - Inactive							•			4			\$7.40
92001-279	200T - Hall/Closet								•		6			\$14.30
93001-503	300T - Bed/Bath								•		6			\$15.70
94002-440	400T - Entry								•		6			\$21.80
94002-442	400T - Entry								•		6		K2	\$21.80
94002-441	400T - Entry								•		6	•	K6	\$21.80
94880-365	488T - Inactive								•		4			\$6.50
93001-505	300T - Bed/Bath									•	6			\$17.00





VALIANT®



MOBILE HOME LOCKS

**KNOBS**

MFG Pro#	Function	Finish									Case Qty.	Code	Keying	Price
		L03	3	5	11P	15	15A	26	26D	3x26				
<b>Valiant® Knob</b>		L03	3	5	11P	15	15A	26	26D	3x26				
92001-282	200V - Hall/Closet		•								6			\$16.80
93001-507	300V - Bed/Bath		•								6			\$18.60
94002-449	400V - Entry		•								6	•	K6	\$26.50
94880-372	488V - Inactive		•								4			\$11.40
<b>Mobile Home Locks</b>		L03	3	5	11P	15	15A	26	26D	3x26	Case Qty.	Code	Keying	Price
92001-271	200M - Hall/Closet		•								6			\$13.70
93001-495	300M - Bed/Bath		•								6			\$15.00
94002-419	400M - Entry		•								6			\$20.50
94002-420	400M - Entry		•								6		K2	\$20.50
92001-270	200M - Hall/Closet							•			6			\$13.90
93001-494	300M - Bed/Bath							•			6			\$15.30
94002-417	400M - Entry							•			6			\$20.90
94002-418	400M - Entry							•			6		K2	\$20.90



DELTA®

## LEVERS

MFG Pro#	Function	Finish								Case Qty.	Code	Keying	Price
		L03	3	5	11P	15	15A	26	26D				
<b>Delta® Lever</b>													
92001-287	200DL - Hall/Closet		•							6			\$28.90
93001-512	300DL - Bed/Bath		•							6			\$30.70
94050-351	405DL - Entry		•							6	•	K6	\$47.90
94880-432	488DL - Inactive		•							4			\$11.70
92001-288	200DL - Hall/Closet			•						6			\$30.00
93001-513	300DL - Bed/Bath			•						6			\$31.80
94050-352	405DL - Entry			•						6	•	K6	\$49.00
94880-433	488DL - Inactive			•						4			\$12.80
92001-289	200DL - Hall/Closet							•		6			\$30.80
93001-514	300DL - Bed/Bath							•		6			\$32.60
94050-353	405DL - Entry							•		6	•	K6	\$50.00
94880-434	488DL - Inactive							•		4			\$13.40
92001-290	200DL - Hall/Closet								•	6			\$30.80
93001-515	300DL - Bed/Bath								•	6			\$32.60
94050-354	405DL - Entry								•	6	•	K6	\$50.00
94880-435	488DL - Inactive								•	4			\$13.40

# America's Number One Selling Lockset.™



DORIAN®

## LEVERS

MFG Pro#	Function	Finish								Case Qty.	Code	Keying	Price
		L03	3	5	11P	15	15A	26	26D				
<b>Dorian® Lever</b>													
92001-291	200DNL - Hall/Closet		•							6			\$28.90
93001-516	300DNL - Bed/Bath		•							6			\$30.70
94050-355	405DNL - Entry		•							6	•	K6	\$47.90
94880-436	488DNL - Inactive		•							4			\$11.70
92001-292	200DNL - Hall/Closet			•						6			\$30.00
93001-517	300DNL - Bed/Bath			•						6			\$31.80
94050-356	405DNL - Entry			•						6	•	K6	\$49.00
94880-437	488DNL - Inactive			•						4			\$12.80
92001-293	200DNL - Hall/Closet					•				6			\$30.80
93001-518	300DNL - Bed/Bath					•				6			\$32.60
94050-357	405DNL - Entry					•				6	•	K6	\$50.00
94880-438	488DNL - Inactive					•				4			\$13.40
92001-294	200DNL - Hall/Closet						•			6			\$30.80
93001-519	300DNL - Bed/Bath						•			6			\$32.60
94050-358	405DNL - Entry						•			6	•	K6	\$50.00
94880-439	488DNL - Inactive						•			4			\$13.40



660 SINGLE CYLINDER DEADBOLT

## DEADBOLTS

MFG Pro#	Function	Finish								Case Qty.	Code	Keying	Price
		L03	3	5	11P	15	15A	26	26D				
<b>Single Cylinder Deadbolt</b>		L03	3	5	11P	15	15A	26	26D				
96600-426	660 - Single Cylinder		•							6			\$23.00
96600-425	660 - Single Cylinder		•							6		K2	\$23.00
96600-419	660 - Single Cylinder		•							6	•	K6	\$23.00
96600-428	660 - Single Cylinder			•						6			\$25.00
96600-427	660 - Single Cylinder			•						6		K2	\$25.00
96600-420	660 - Single Cylinder			•						6	•	K6	\$25.00
96600-527	660 - Single Cylinder					•				6		K2	\$25.00
96600-432	660 - Single Cylinder						•			6			\$25.00
96600-431	660 - Single Cylinder						•			6		K2	\$25.00
96600-416	660 - Single Cylinder						•			6	•	K6	\$25.00
96600-434	660 - Single Cylinder							•		6			\$25.00
96600-433	660 - Single Cylinder							•		6		K2	\$25.00
96600-417	660 - Single Cylinder							•		6	•	K6	\$25.00
96600-424	660 - Single Cylinder								•	6			\$23.50
96600-423	660 - Single Cylinder								•	6		K2	\$23.50
96600-418	660 - Single Cylinder								•	6	•	K6	\$23.50
<b>One-Sided Deadbolt</b>		L03	3	5	11P	15	15A	26	26D	Case Qty.	Code	Keying	Price
96630-058	663 - One Sided Deadbolt		•							4			\$11.00
96630-059	663 - One Sided Deadbolt - RCL RCS		•							4			\$11.00
96630-060	663 - One Sided Deadbolt			•						4			\$11.70
96630-061	663 - One Sided Deadbolt - RCL RCS			•						4			\$11.70

# America's Number One Selling Lockset.™



665 DOUBLE CYLINDER DEADBOLT

## DEADBOLTS

MFG Pro#	Function	Finish								Case Qty.	Code	Keying	Price
		L03	3	5	11P	15	15A	26	26D				
<b>Double Cylinder Deadbolt</b>													
96650-395	665 - Double Cylinder		•							6			\$29.60
96650-394	665 - Double Cylinder		•							6		K2	\$29.60
96650-390	665 - Double Cylinder		•							6	•	K6	\$29.60
96650-397	665 - Double Cylinder			•						6			\$31.60
96650-396	665 - Double Cylinder			•						6		K2	\$31.60
96650-391	665 - Double Cylinder			•						6	•	K6	\$31.60
96650-437	665 - Double Cylinder					•				6		K2	\$31.60
96650-399	665 - Double Cylinder						•			6			\$31.60
96650-398	665 - Double Cylinder						•			6		K2	\$31.60
96650-388	665 - Double Cylinder						•			6	•	K6	\$31.60
96650-401	665 - Double Cylinder							•		6			\$31.60
96650-400	665 - Double Cylinder							•		6		K2	\$31.60
96650-393	665 - Double Cylinder							•		6	•	K6	\$31.60
96650-403	665 - Double Cylinder								•	6			\$30.20
96650-402	665 - Double Cylinder								•	6		K2	\$30.20
96650-389	665 - Double Cylinder								•	6	•	K6	\$30.20
<b>Mobile Home Locks</b>													
96600-429	660M - Mobile Home		•							6			\$21.70
96600-422	660M - Mobile Home		•							6		K2	\$21.70
96600-430	660M - Mobile Home								•	6			\$22.10
96600-421	660M - Mobile Home								•	6		K2	\$22.10



POLO® COMBO PACK



TYLO® COMBO PACK

## COMBO PACKS

MFG Pro#	Function	Finish								Case Qty.	Code	Keying	Price
<b>690 Combo Pack - Polo® Knob with Single Cylinder Deadbolt</b>		L03	3	5	11P	15	15A	26	26D				
96900-255	690P		•							6			\$48.20
96900-256	690P		•							6		K2	\$48.20
96900-250	690P		•							6	•	K6	\$48.20
96900-257	690P			•						6			\$52.00
96900-258	690P			•						6		K2	\$52.00
96900-251	690P			•						6	•	K6	\$52.00
96900-300	690P				•					6		K2	\$55.10
96900-295	690P								•	6	•	K6	\$48.20
<b>690 Combo Pack - Tylo® Knob with Single Cylinder Deadbolt</b>		L03	3	5	11P	15	15A	26	26D	Case Qty.	Code	Keying	Price
96900-261	690T		•							6			\$46.00
96900-262	690T		•							6		K2	\$46.00
96900-253	690T		•							6	•	K6	\$46.00
96900-263	690T			•						6			\$49.70
96900-264	690T			•						6		K2	\$49.70
96900-254	690T			•						6	•	K6	\$49.70
96900-259	690T								•	6			\$47.10
96900-260	690T								•	6		K2	\$47.10
96900-252	690T								•	6	•	K6	\$47.10
<b>690 Combo Pack - Valiant® Knob with Single Cylinder Deadbolt</b>		L03	3	5	11P	15	15A	26	26D	Case Qty.	Code	Keying	Price
96900-301	690V		•							6	•	K6	\$51.40
<b>690 Combo Pack - Delta® Lever with Single Cylinder Deadbolt</b>		L03	3	5	11P	15	15A	26	26D	Case Qty.	Code	Keying	Price
96900-312	690DL								•		•	K6	\$72.40
<b>690 Combo Pack - Dorian® Lever with Single Cylinder Deadbolt</b>		L03	3	5	11P	15	15A	26	26D	Case Qty.	Code	Keying	Price
96900-310	690DNL		•								•	K6	\$69.90
96900-311	690DNL			•							•	K6	\$72.90
<b>695 Combo Pack - Polo® Knob with Double Cylinder Deadbolt</b>		L03	3	5	11P	15	15A	26	26D	Case Qty.	Code	Keying	Price
96950-165	695P		•							6			\$55.10
96950-166	695P		•							6		K2	\$55.10
96950-160	695P		•							6	•	K6	\$55.10
96950-167	695P			•						6			\$59.00
96950-168	695P			•						6		K2	\$59.00
96950-161	695P			•						6	•	K6	\$59.00

# America's Number One Selling Lockset.™



TYLO® COMBO PACK WITH DOUBLE CYLINDER DEADBOLT

## COMBO PACKS

MFG Pro#	Function	Finish								Case Qty.	Code	Keying	Price
695 Combo Pack - Tylo® Knob with Double Cylinder Deadbolt		L03	3	5	11P	15	15A	26	26D				
96950-171	695T		•							6			\$52.80
96950-172	695T		•							6		K2	\$52.80
96950-163	695T		•							6	•	K6	\$52.80
96950-173	695T			•						6			\$56.60
96950-174	695T			•						6		K2	\$56.60
96950-164	695T			•						6	•	K6	\$56.60
96950-169	695T								•	6			\$53.70
96950-170	695T								•	6		K2	\$53.70
96950-162	695T								•	6	•	K6	\$53.70
695 Combo Pack - Valiant® Knob with Double Cylinder Deadbolt		L03	3	5	11P	15	15A	26	26D	Case Qty.	Code	Keying	Price
96950-178	695V		•							6	•	K6	\$58.20
Pre-Pack - Special Orders Only		L03	3	5	11P	15	15A	26	26D	Case Qty.	Code	Keying	Price
91860-026	186 690T		•							36	•	K6	\$46.00
91860-025	186 690P		•							36	•	K6	\$48.20
91860-028	186-695T		•							36	•	K6	\$52.80
91870-024	187 242P		•							18	•	K2	\$92.60
91870-026	187 242T		•							18	•	K2	\$91.90
91870-030	187 243T		•							36	•	K2	\$44.20
91870-031	187 244		•							36	•		\$47.70
95150-051	515 400T		•							72	•	K6	\$21.20
95150-053	515 400P		•							72	•		\$23.40
95160-030	516 200T		•							72			\$14.00
95160-032	516 200P		•							72			\$15.90
95180-029	518 300T		•							72			\$15.50
95180-031	518 300P		•							72			\$17.60
91860-027	186 690T			•						36	•	K6	\$52.00
91870-027	187 242T			•						18	•	K2	\$99.30
95150-052	515 400T			•						72	•		\$22.70
95160-031	516 200T			•						72			\$15.60
95180-030	518 300T			•						72			\$17.00



POLO® PROJECT PACK



TYLO® PROJECT PACK

## PROJECT PACKS

MFG Pro#	Function	Finish								Case Qty.	Code	Keying	Price
<b>Project Pack - 2 Keyed Polo® Knobs with 2 Single Cylinder Deadbolts</b>													
92420-029	242P	L03	3	5	11P	15	15A	26	26D	6	•	K2	\$92.60
<b>Project Pack - 2 Keyed Tylo® Knobs with 2 Single Cylinder Deadbolts</b>													
92420-031	242T	L03	3	5	11P	15	15A	26	26D	6	•	K2	\$91.90
92420-032	242T			•						6	•	K2	\$99.30
92420-036	242T								•	6	•	K2	\$94.20
<b>Project Pack - 2 Keyed Valiant® Knobs with 2 Single Cylinder Deadbolts</b>													
92420-038	242V	L03	3	5	11P	15	15A	26	26D	6			\$92.60
<b>Project Pack - 2 Keyed Tylo® Knobs</b>													
92430-022	243T	L03	3	5	11P	15	15A	26	26D	6	•	K2	\$44.20
92430-023	243T			•						6	•	K2	\$47.30
<b>Project Pack - 2 Single Cylinder Deadbolts</b>													
92440-020	244	L03	3	5	11P	15	15A	26	26D	6			\$47.70



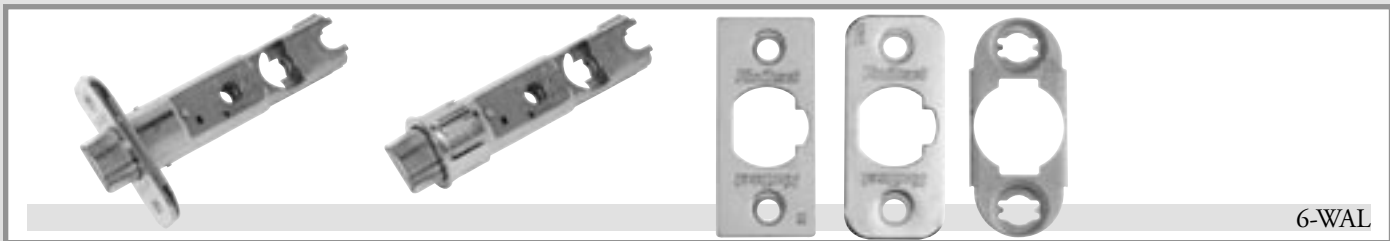

6-WAL

**PARTS**

MFG Pro#	Function	Finish								Case Qty.	Price	Quantity
		L03	3	5	11P	15	15A	26	26D			
<b>Plain Latches</b>												
81826-001	6WAL Plain Latch		•							6	\$6.20	6/Tray
<b>Dead Latches</b>												
83014-015	Security - 5" Deadlatch, 1" Front		•							6	\$10.20	6/Tray
81825-001	19841 6WAL DL		•							6	\$8.50	6/Tray
<b>Deadbolt Latches</b>												
86084-026	6084-18 CP DB ADJ 3 USP		•							6	\$9.10	6/Tray
84504-016	4504-18 CP DB RFAL		•							6	\$11.00	6/Tray
<b>Mobile Home Conversion Kits</b>												
80340-001	12077 CP, DB, RFL, CNV Kit		•					•		6	\$8.60	6
83228-001	22827 CP, DL, 2WAL, DI 3/26 CNV Kit		•					•		6	\$7.50	6
83229-001	12003 CP, PI, 7/8RF, 3/26 CNV Kit		•					•		6	\$5.40	6
<b>Strikes</b>												
83437-037	3437-01 3 CP, STRK, SQ CNR FULL LIP		•							6	\$2.80	6
83222-026	3222-01 3 CP STRK, DB		•							6	\$2.80	6
83437-038	3437-015 5 CP STRK, SQ CNR FULL LIP			•						6	\$3.40	6
83437-039	3437-01 26D CP STRK, SQ CNR FULL LIP							•		6	\$2.80	6

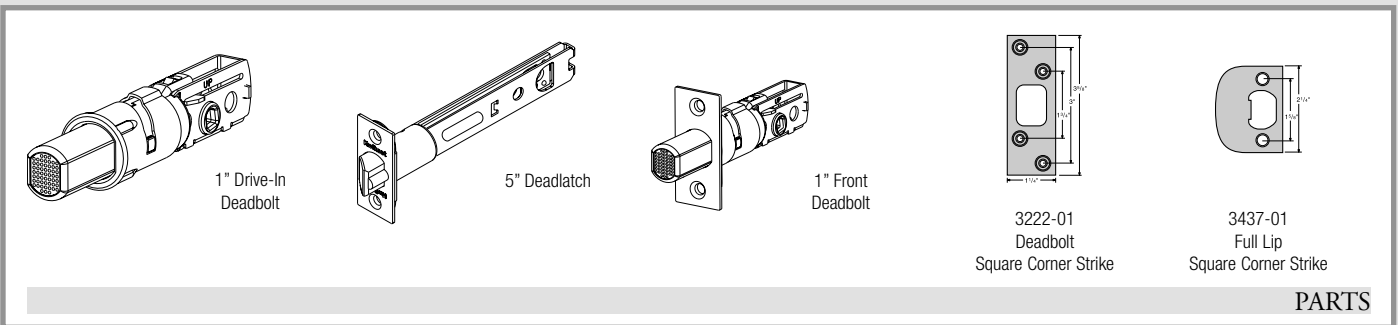

PARTS



REKEYING KIT

KEYING		
Part #	Description	Price
<b>Keying</b>		
272	272 Rekeying Kit	\$145.00
83108	#1 Master Pin .023"	\$0.10
83110	#2 Master Pin .046"	\$0.10
83112	#3 Master Pin .069"	\$0.10
83113	#4 Master Pin .092"	\$0.10
83114	#5 Master Pin .115"	\$0.10
83125	#6 Master Pin .138"	\$0.10
83100	#1 Bottom Pin .172"	\$0.10
83101	#2 Bottom Pin .195"	\$0.10
83103	#3 Bottom Pin .218"	\$0.10
83105	#4 Bottom Pin .241"	\$0.10

KEYING		
Part #	Description	Price
<b>Keying</b>		
83106	#5 Bottom Pin .264"	\$0.10
83107	#6 Bottom Pin .287"	\$0.10
81858	Regular Top Pin .180"	\$0.10
83117	PK Top Pin .160"	\$0.10
80370	Regular Anti-Pick Top Pin .180"	\$0.14
80369	PK Anti-Pick Top Pin .160"	\$0.14
84345	Knob Plug Retainer	\$0.10
84215	Deadlock Plug Retainer	\$0.10
87619	Knob Control Lug (Locking Bar)	\$0.14
87809	Deadlock Control Lug (Locking Bar)	\$0.40
80371	Low Profile Deadbolt Spring Cover	\$0.65

KEYING		
Part #	Description	Price
<b>Keying</b>		
85757	Spring Cover (5-Pin)	\$0.29
83561	Spring Cover (6-Pin)	\$0.32
87632	Spring	\$25.10
82208	PK Balls	\$0.10
81777	Tumbler Spring	\$0.10
81467	Cylinder Removal Tool	\$1.15
80152	Plug Follower	\$3.80
80049	Key Gauge	\$4.30

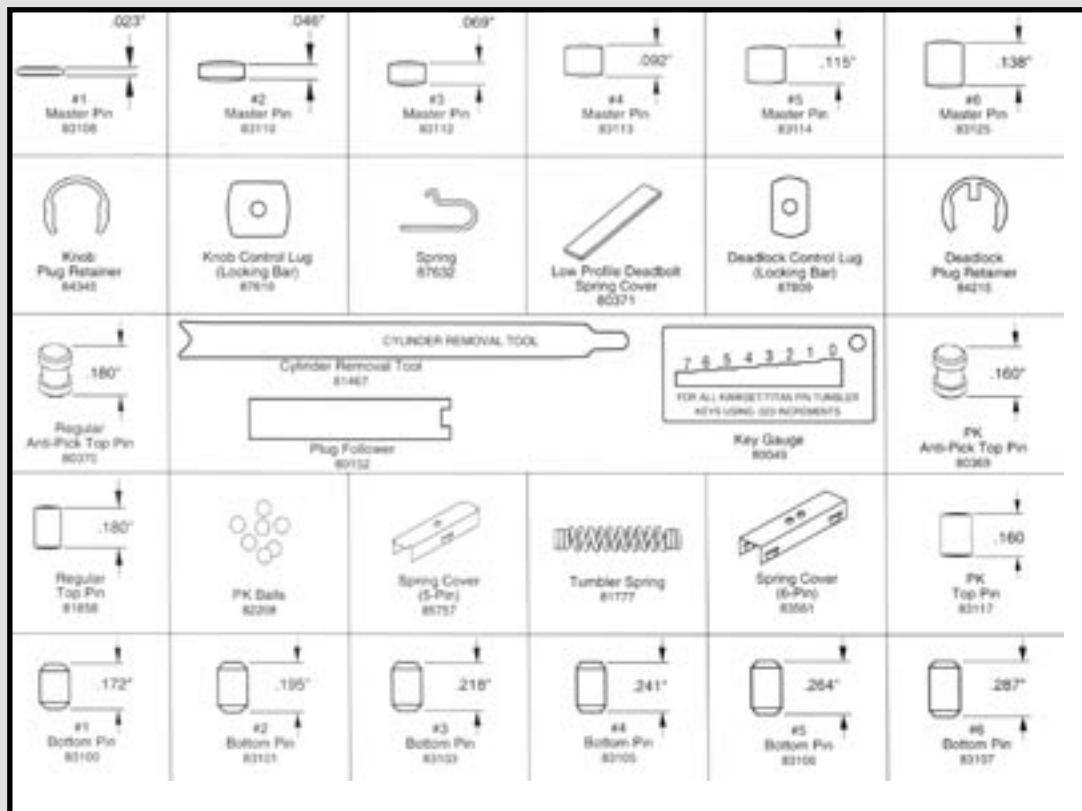

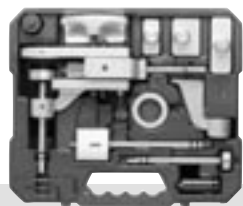

*Drill not included*

138 INSTALLATION KIT

## 138 INSTALLATION KIT & REPLACEMENT PARTS

MFG Pro#	Function	Quantity Per Pack	Master Pack Quantity	Price
<b>138 Installation Kit &amp; Replacement Parts</b>				
91380-001	138 Installation Kit	1	1	\$365.90
89900-001	Jig with wood arm guide	1	1	\$174.40
89901-001	Wood door in-line guide arm	1	1	\$38.50
89902-001	Metal door in-line guide arm	1	1	\$38.50
<b>Drill Bits</b>				
		Quantity Per Pack	Master Pack Quantity	Price
89903-001	1" Spade Bit	1	3	\$12.80
89904-001	2-1/8" multi spur bit	1	3	\$56.70
89905-001	1-1/2" multi spur bit	1	3	\$47.10
89906-001	2-1/8" hold saw bit	1	3	\$11.80
89907-001	Hole saw mandrel	1	1	\$9.60
89908-001	Snap Rings	6	3	\$7.50
<b>Mortise Tools</b>				
		Quantity Per Pack	Master Pack Quantity	Price
89909-001	Full lip strike mortise tool	1	3	\$21.40
89910-001	Full lip round corner strike blades	3	3	\$6.40
89911-001	Full lip square corner strike blades	3	3	\$6.40
89912-001	Latch mortise tool	1	3	\$22.50
89913-001	Latch round corner blades	3	3	\$7.50
89914-001	Latch square corner blades	3	3	\$7.50
89915-001	Security strike mortise tool	1	1	\$23.50
89916-001	Security square corner blades	3	3	\$8.60
89917-001	Security round corner blades	3	3	\$8.60
<b>Miscellaneous Parts</b>				
		Quantity Per Pack	Master Pack Quantity	Price
89918-001	Quick bit changer	1	1	\$15.00
89919-001	Strike locator	1	1	\$3.40
89920-001	Strike locator tip	3	1	\$4.50
89921-001	Kit box	1	1	\$19.30
89922-001	Jig bushing	3	1	\$14.70
89923-001	1-1/2" Adapter ring	1	1	\$6.70
89924-001	663 Boring depth stop	1	1	\$2.20
89925-001	Boring template	1	1	\$1.90
89926-001	1/8" Hex ring	1	1	\$0.50
130WD	Wood door installation kit	1	3	\$18.80



334 PASSAGE



335 PRIVACY

**ROUND POCKET DOOR LOCK**

MFG Pro#	Function	Finish										Case Qty.	Price	
		L03	3	5	11P	15	15A	26	26D	32	3x32			
<b>Round Pocket Door Lock</b>														
93340-015	334 - Passage		•										6	\$18.80
93350-015	335 - Privacy		•										6	\$20.90
93340-016	334 - Passage			•									6	\$18.80
93350-016	335 - Privacy			•									6	\$20.90
93340-017	334 - Passage					•							6	\$18.80
93350-017	335 - Privacy					•							6	\$20.90
93340-018	334 - Passage						•						6	\$18.80
93350-018	335 - Privacy						•						6	\$20.90



NOTCH POCKET DOOR LOCKS

## TRIMS

Part #	Function	Finish										Dimensions	Case Qty.	Price	
		L03	3	5	11P	15	15A	26	26D	3x26					
<b>Trims</b>															
239	Curved Colonial Handle		•											4	\$38.20
249	Medium Rectangular Rosette		•									7-1/4"x3-3/8"	5	\$12.80	
288	Small Rectangular Rosette		•										5	\$12.40	
293	Round Rosette		•									3-13/16"	4	\$9.30	
214	Large Modernization Kit		•									3-1/2" x 10-1/2"	10	\$41.00	
215	Small Modernization Kit		•									7-1/4" x 3-3/8"	10	\$28.70	
262	Horizontal Combo		•									3-1/2" x 8-1/2"	5	\$19.20	
263	Large Horizontal Combo		•									3-1/2" x 10-1/2"	5	\$40.40	
239	Curved Colonial Handle			•									4	\$40.40	
293	Round Rosette			•								3-13/16"	5	\$10.50	
262	Horizontal Combo			•								3-1/2" x 8-1/2"	5	\$21.90	
239	Curved Colonial Handle					•							4	\$40.10	
293	Round Rosette					•						3-13/16"	4	\$9.80	
293	Round Rosette								•			3-13/16"	4	\$9.80	
262	Horizontal Combo								•			3-1/2" x 8-1/2"	5	\$21.40	
<b>Notch Pocket Door Locks</b>		<b>L03</b>	<b>3</b>	<b>5</b>	<b>11P</b>	<b>15</b>	<b>15A</b>	<b>26</b>	<b>26D</b>	<b>3x26</b>	<b>Dimensions</b>	<b>Case Qty.</b>	<b>Price</b>		
332	Passage Notch Pocket Door Lock		•									12	\$12.60		
333	Privacy Notch Pocket Door Lock		•									12	\$20.40		
332	Passage Notch Pocket Door Lock			•								12	\$13.40		
333	Privacy Notch Pocket Door Lock			•								12	\$21.70		
332	Passage Notch Pocket Door Lock									•		12	\$14.70		
333	Privacy Notch Pocket Door Lock									•		12	\$21.30		

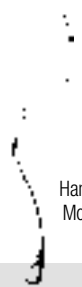

Handle Trim  
Model 239



Trim Rosette  
Model 288



Round Trim  
Rosette  
Model 293



Modernization Kit  
Model 214

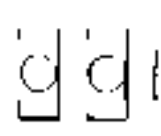

Modernization Kit  
Model 215



Combo Trim  
Escutcheon  
Model 262

## TRIMS

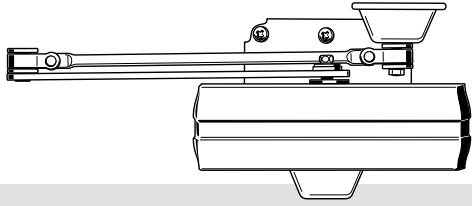

AUTOMATIC DOOR CLOSERS

**KWIKSET CLOSERS**

Part #	Function	Finish	Maximum Door Weight (lbs)	Maximum Door Size	Quantity	Price
<b>Closers</b>						
960E	Automatic Door Closer	Eggshell	60	36" x 80"	5	\$56.30
960C	Automatic Door Closer	Cocoa	60	36" x 80"	5	\$56.30

Maximum degree of opening for all closers is 180.  
All Closers are reversible for right or left handed doors.  
The minimum top rail or top jamb is 1 3/4".

# Retail Merchandising Components

## HEADER GRAPHICS

### Two-Foot Header

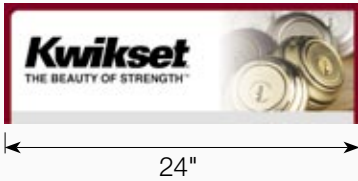

### Four-Foot Header

Model #90350-015 (Wire Frame)  
Model #90350-016 (Top Mount)



### Eight-Foot Header

Model# 90350-017 (Wire Frame)  
Model# 90350-018 (Top Mount)



### Twelve-Foot Header

Model #90350-020 (Wire Frame)  
Model #90350-021 (Top Mount)

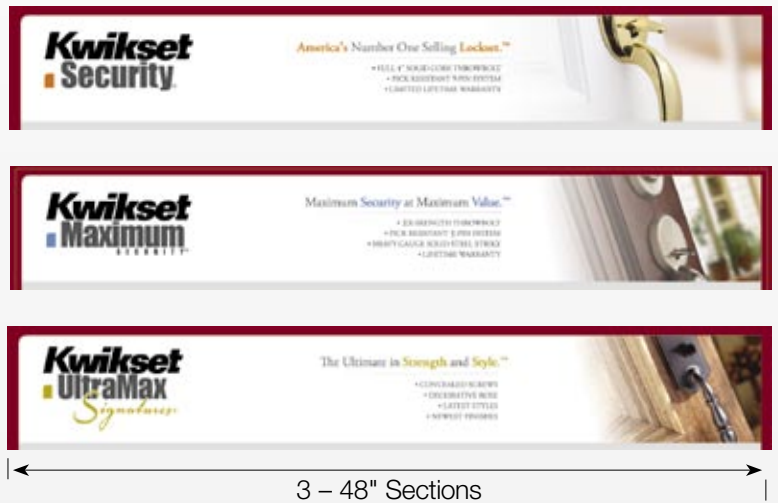

## HEADER APPLICATIONS

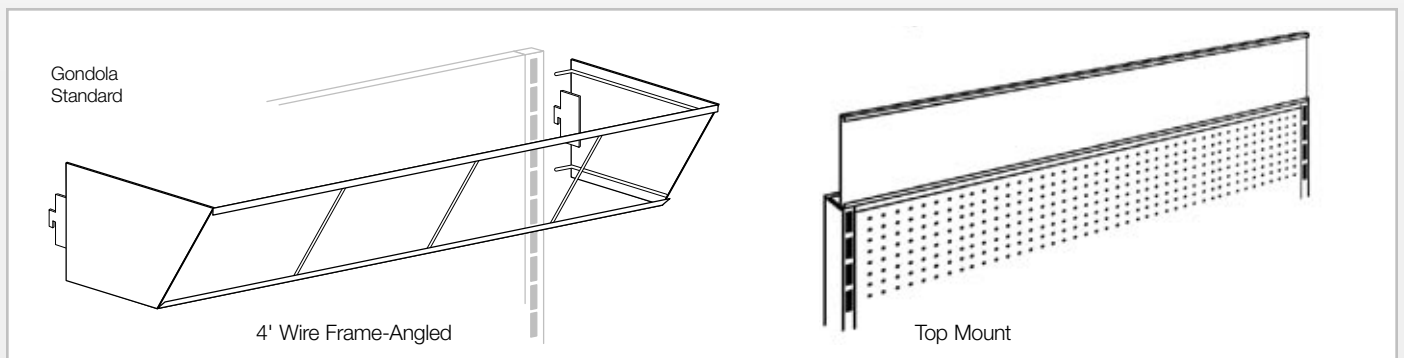

### Adjustable Frame

Model #90350-062 (12" depth)  
Frame adjusts to 12" & 16" depths

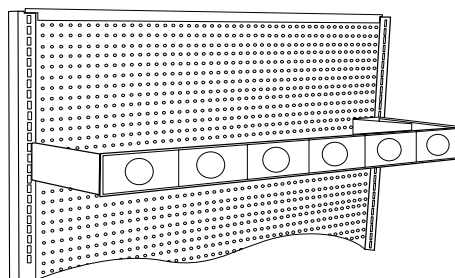



Copyright ©2006 Kwikset Corporation  
Lake Forest, California 92610  
Products and specifications subject to change without notice.  
LIT 7-0-01 5/06  
IN-L-K10009

**Kwikset**  
A BLACK & DECKER COMPANY

[www.kwikset.com](http://www.kwikset.com)  
1-800-327-LOCK (5625)