

TANDBERG 2500

User Manual

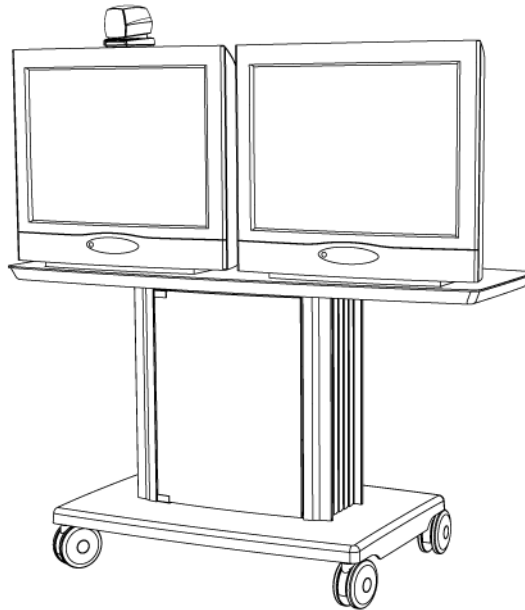

Software version E3/B8

D12155-10

This document is not to be reproduced in whole or in part
without permission in writing from:

TANDBERG

Trademarks and copyright

COPYRIGHT © 2004, TANDBERG

Philip Pedersensvei 22

1366 Lysaker, Norway, Tel: +47 67 125 125, Fax: +47 67 125 234

All rights reserved. This document contains information that is proprietary to TANDBERG. No part of this publication may be reproduced, stored in a retrieval system, or transmitted, in any form, or by any means, electronically, mechanically, by photocopying, or otherwise, without the prior written permission of TANDBERG. Nationally and internationally recognized trademarks and tradenames are the property of their respective holders and are hereby acknowledged.

Portions of this software are © 1996-2004 RADVision Ltd. All intellectual property rights in such portions of the Software and documentation are owned by RADVision and are protected by United States copyright laws, other applicable copyright laws and international treaty provisions. RADVision and its suppliers retain all rights not expressly granted.

Disclaimer

The information in this document is furnished for informational purposes only, is subject to change without prior notice, and should not be construed as a commitment by TANDBERG.

The information in this document is believed to be accurate and reliable, however TANDBERG assumes no responsibility or liability for any errors or inaccuracies that may appear in this document, nor for any infringements of patents or other rights of third parties resulting from its use. No license is granted under any patents or patent rights of TANDBERG.

This document was written by the Technical Support Department of TANDBERG, Norway. We are committed to maintaining a high level of quality in all our documentation. Towards this effort, we welcome your comments and suggestions regarding the content and structure of this document. Please fax or mail your comments and suggestions to the attention of:

Product Support Department
TANDBERG, Philip Pedersensvei 22
1366 Lysaker, Norway
Tel: +47 67 125 125
Fax: +47 67 125 234

Environmental Issues

Thank you for buying a product which contributes to a reduction in pollution and thereby helps save the environment.

Our products reduce the need for travel and transport and thereby reduce pollution.
Our products have either none or few consumable parts (chemicals, toner, gas, paper).
Our products are low energy consuming products.

Battery handling:

Batteries for the Remote Control are Long Life and Alkaline batteries saving the environment, please follow guidelines on the packing material for handling and disposal of the batteries.

Waste handling:

No need to send material back to TANDBERG as there are no consumables to take care of. Please contact your local dealer for information on recycling the product by sending the main parts of the product for disassembly at local electronic waste stations, marking recyclable parts so the waste station can disassemble and re-use these parts.

Production of products:

Our factories employ the most efficient environmental methods for reducing waste and pollution and ensuring the products are recyclable.

Operator Safety Summary

For your protection, please read these safety instructions completely before operating the equipment and keep this manual for future reference. The information in this summary is intended for operators. Carefully observe all warnings, precautions and instructions both on the apparatus and in the operating instructions.



Equipment Markings

The lightning flash symbol within an equilateral triangle is intended to alert the user to the presence of uninsulated “dangerous voltages” within the product’s enclosure that may be of sufficient magnitude to constitute a risk of electrical shock.

The exclamation mark within an equilateral triangle is intended to alert the user to the presence of important operating and maintenance (servicing) instructions within literature accompanying the equipment.

Warnings

Water and moisture - Do not operate the equipment under or near water - for example near a bathtub, kitchen sink, or laundry tub, in a wet basement, or near a swimming pool or in areas with high humidity.

Cleaning - Unplug the apparatus from the wall outlet before cleaning or polishing. Do not use liquid cleaners or aerosol cleaners. Use a lint-free cloth lightly moistened with water for cleaning the exterior of the apparatus.

Ventilation - Do not block any of the ventilation openings of the apparatus. Install in accordance with the installation instructions. Never cover the slots and openings with a cloth or other material. Never install the apparatus near heat sources such as radiators, heat registers, stoves, or other apparatus (including amplifiers) that produce heat.

Grounding or Polarization - Do not defeat the safety purpose of the polarized or grounding-type plug. A polarized plug has two blades with one wider than the other. A grounding type plug has two blades and a third grounding prong. The wide blade or third prong is provided for your safety. If the provided plug does not fit into your outlet, consult an electrician.

Power-Cord Protection - Route the power cord so as to avoid it being walked on or pinched by items placed upon or against it, paying particular attention to the plugs, receptacles, and the point where the cord exits from the apparatus.

Attachments - Only use attachments as recommended by the manufacturer.



Accessories - Use only with a cart, stand, tripod, bracket, or table specified by the manufacturer, or sold with the apparatus. When a cart is used, use caution when moving the cart/apparatus combination to avoid injury from tip-over.

Lightning - Unplug this apparatus during lightning storms or when unused for long periods of time.

ISDN cables - CAUTION - To reduce the risk of fire, use only No. 26 AWG or larger telecommunication line cord.

Servicing - Do not attempt to service the apparatus yourself as opening or removing covers may expose you to dangerous voltages or other hazards, and will void the warranty. Refer all servicing to qualified service personnel.

Damaged Equipment - Unplug the apparatus from the outlet and refer servicing to qualified personnel under the following conditions:

- When the power cord or plug is damaged or frayed
- If liquid has been spilled or objects have fallen into the apparatus
- If the apparatus has been exposed to rain or moisture
- If the apparatus has been subjected to excessive shock by being dropped, or the cabinet has been damaged
- If the apparatus fails to operate in accordance with the operating instructions

Contents

Introduction	7
Menu structure	8
The TANDBERG 2500 Videoconferencing System	9
At a glance — the TANDBERG 2500 system	9
Installation	13
Precautions	13
Unpacking	13
Connecting cables	15
Monitor configuration	16
System configuration	17
Getting started	20
System start-up	20
Welcome menu	20
Basics	21
Making and ending calls	22
Directory	27
Microphone on/off	30
General use	30
Adjusting volume	30
View outgoing video (selfview)	30
Do Not Disturb / Sleep Mode	31
Selecting video sources	32
Controlling the Main Camera	32
Voice Activated Camera Positioning	33
Presets	34
Far end camera control (FECC)	35
Sending and receiving snapshots	36
Duo Video *	37
MultiSite (MCU)*	39
PC Presenter	43
PC SoftPresenter *	43

IMPORTANT
PLEASE READ THIS
SECTION CAREFULLY FOR
OPTIMAL SYSTEM SET-UP.

* - Optional feature.

Web-interface	44
T.120 and other PC applications*	45
Advanced use	46
Main menu	46
Call quality	47
Presentations	49
Utilities	51
MCU services	54
Audio Settings	58
Video Settings	65
Terminal Settings	69
Network Configuration	69
LAN Settings	76
Call Settings	84
Dataport configuration	87
Language	89
Software Options	89
Diagnostics	90
Peripheral Equipment	94
Interfaces	94
Dual Monitor	96
Document camera	97
Multiple controllable cameras	98
AudioScience microphone	99
Tracker	99
Video Cassette Recorder (VCR)	100
Telephone Add-On	101
Extra fixed cameras	101
PC applications	102
PC SoftPresenter	102
Additional microphones	103
Appendices	104
Index	114

Introduction

This User Manual is provided to help you make the best use of your TANDBERG system. The TANDBERG system offers superior audio and video quality in a fully-featured unit.

Main Features:

- Supports videoconferencing via both IP and ISDN networks.
- Selection of up to 1.5 Mbps call quality.
- Built-in MultiSite^{TF}* - a maximum of 5 sites including a minimum of 1 telephone call can participate in joint meetings, each benefiting from the same superb audio and video quality. Both Continuous Presence and Voice Switched mode is supported. A combination of ISDN and IP participants is possible. The TANDBERG videoconferencing system can also be used purely as an audio-bridge (with an ISDN connection).
- Secure Conference^{TF} - Embedded encryption for both Point to Point and Multipoint call privacy and security.
- Natural Presenter Package* consisting of:
 - Duo Video^{TF} - allows participants at the far end to simultaneously watch a presenter on one screen and a live presentation on the adjoining screen.
 - Digital Clarity^{TF} - participants enjoy presentations of exceptionally high quality resolution video.
 - PC Presenter^{TF} - an easily accessible PC connection plug supporting XGA resolution.
 - PC SoftPresenter^{TF} - show PC images via your LAN connection supporting XGA resolution.
- Natural Video^{TF} - 60 fields per second true interlaced picture.
- Downspeeding^{TF} - if channels are dropped during a videoconferencing session, the connection is automatically maintained without interruption.
- Streaming – allows broadcasting of audio/video via an IP network.
- W.A.V.E (Wide Angle View) Camera - delivers the widest angle of view in the industry.
- Web-interface for streaming, text chat/closed captioning, system management, diagnostics and software uploads.
- Worldwide compatibility with other standards-based videoconferencing systems.

TIP IN THIS GUIDE, WE'VE INCLUDED HELPFUL TIPS AND NOTES. THEY APPEAR LIKE THIS ONE.

* - option. To check which options are installed, press MENU and the Quick key 'System Info'.

TF- TANDBERG first.

Menu structure

The on-screen menu structure is shown below.

Press the **MENU** key on the remote control to enter or leave the Main Menu.

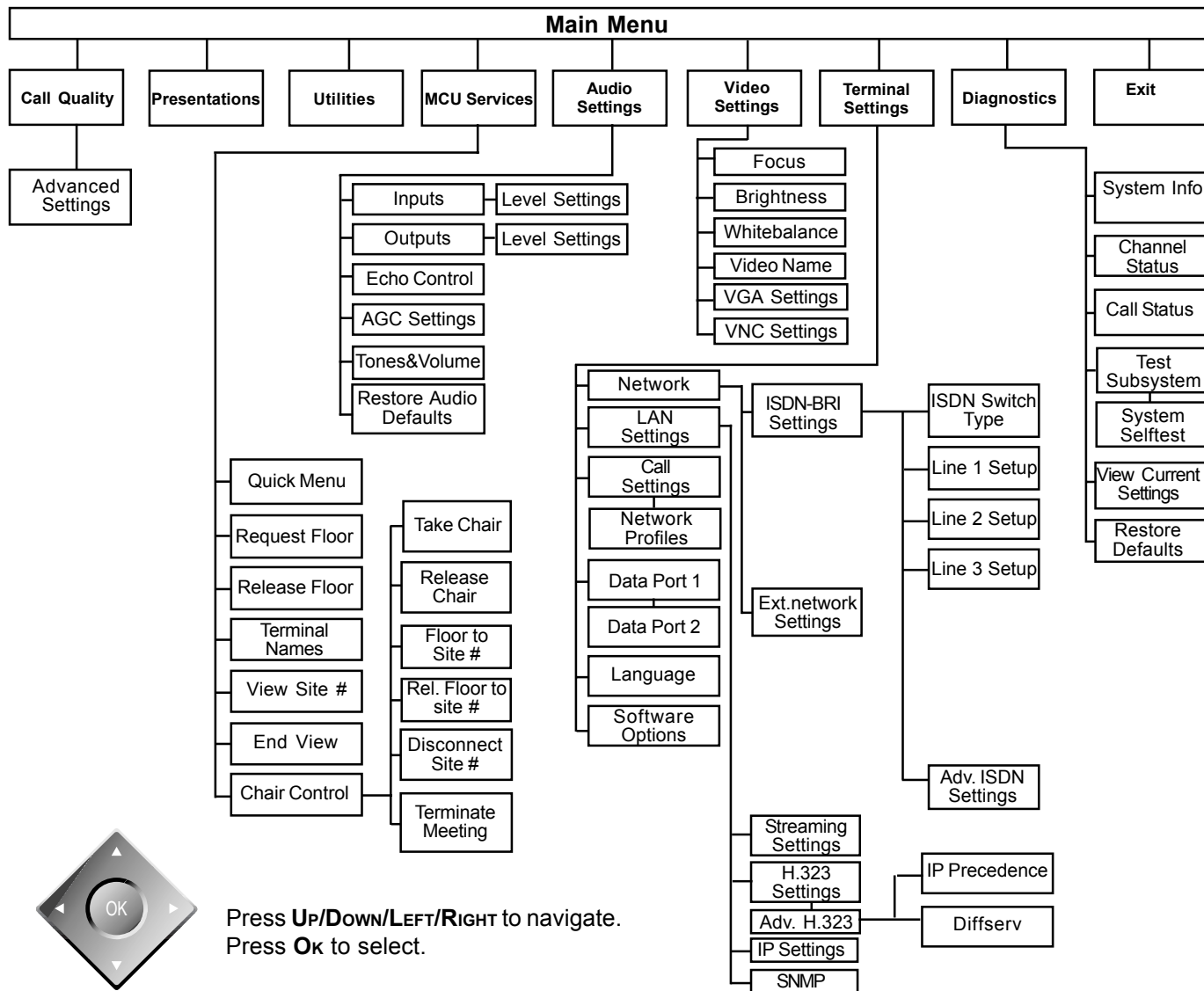

Press **Up/Down/Left/Right** to navigate.
Press **Ok** to select.

The TANDBERG 2500 Videoconferencing System

At a glance — the TANDBERG 2500 system

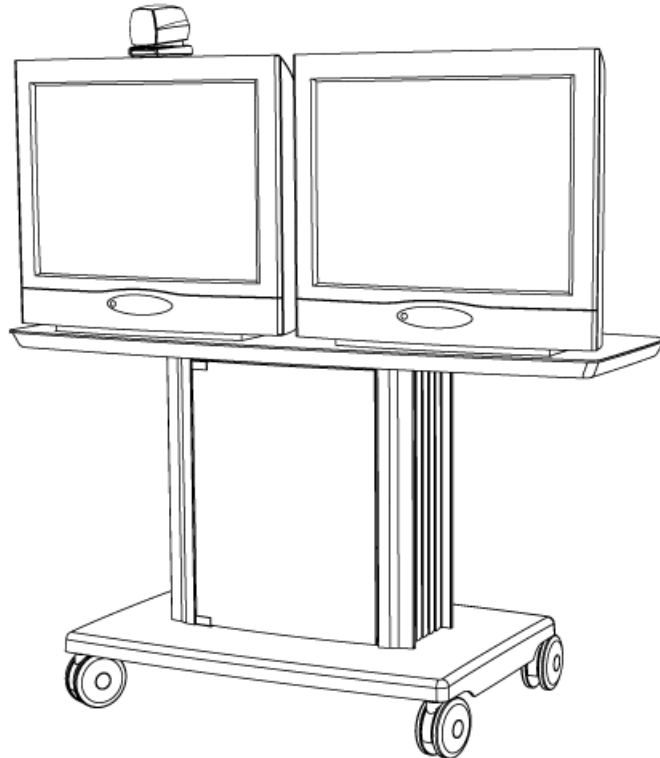

W.A.V.E. II Camera



The Main Camera is mounted on top of the monitor. The Main Camera includes a high quality color camera with a fast pan/tilt/zoom action. The Main Camera is controlled by the system's infra-red remote control and operates pan/tilt, focus and zoom.

You can pre-store up to ten camera positions using the remote control.

Monitor(s)

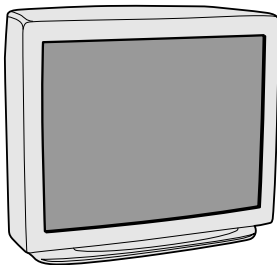

The monitor displays the far-end and near-end videoconferencing sites in addition to the menus, video from connected video sources and high-resolution images.

You can also connect a second monitor for displaying self-view, still images and Duo Video.

Codec

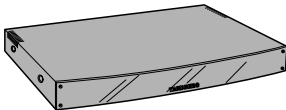

The Codec is the heart of the system. The main task for the Codec is the compression of outgoing video, audio and data, the transmission of this information to the far end and the decompression of the incoming information. Hence the name Codec.

Table microphone

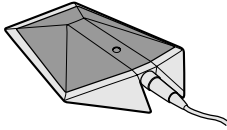

The high quality table microphone is specially designed to be used on a table during a video conference.

The ideal location for the microphone is on a flat surface at least 2m (6.5 ft) from the front of the system. The microphone cable should always point towards the system.

You can connect up to three microphones.

The system will automatically equalize sound levels. Loud and soft voices are picked up and transmitted to the far end at approximately the same level.

Installation

Precautions

- Never install telephone wiring during a lightning storm.
- Never install telephone jacks in wet locations unless the jack is specifically designed for wet locations.
- Never touch uninstalled telephone wires or terminals unless the telephone line has been disconnected at the network interface.
- Use caution when installing or modifying telephone lines.
- Avoid using a telephone (other than a cordless type) during an electrical storm. There may be a remote risk of electrical shock from lightning.
- Do not use the telephone to report a gas leak in the vicinity of the leak.
- The socket outlet shall be installed near to the equipment and shall be easily accessible.
- Never install cables without first switching the power OFF.
- 1TR6 network type is not approved for connection directly to the telecommunications network. This network type is only to be used behind a PABX.
- X.21 network type is not approved for connection directly to the telecommunications network. This network type is only to be used together with already approved equipment, and is not meant for direct connections to the telecommunication networks.
- V.35/RS-449/RS-366 network type is not approved for connection directly to the telecommunications network. This network type is only to be used together with already approved equipment, and is not intended for direct connection to the telecommunication networks.
- This product complies with directives: LVD 73/23/EC, EMC 89/366/EEC, R&TTE 99/5/EEC

Unpacking

To avoid damage to the unit during transportation the system is delivered as separate components:

- Cabinet
- Top plate (when using two monitors)
- High quality monitor (one or two, depending on configuration). XGA monitors are optional.

Inside the cabinet you will find the accessories box which will contain the following:

- W.A.V.E. II Camera
- Table Microphone
- Remote Control
- Documentation

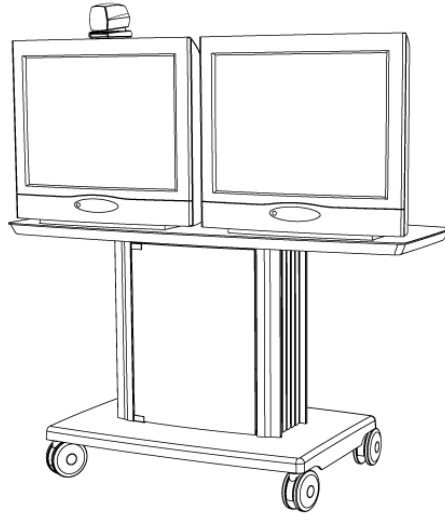

- Place the monitor on top of the cabinet/top plate and ensure it is stable.
- You may fasten the monitor to the cabinet using the securing kit.
- Take the camera and remove the plastic backing from the double sided tape-pads on the base of the unit. Place the camera centrally, on top of the monitor close to the front. If the system has two monitors, place the camera on the left monitor (where menus and incoming picture will be displayed).

NOTE IMPORTANT

THE CAMERA SHOULD BE ALIGNED WITH THE FRONT EDGE OF THE MONITOR TO ENSURE THAT THE IR-SENSOR IN THE CAMERA CAN PICK UP SIGNALS FROM THE REMOTE CONTROL.

Connecting cables

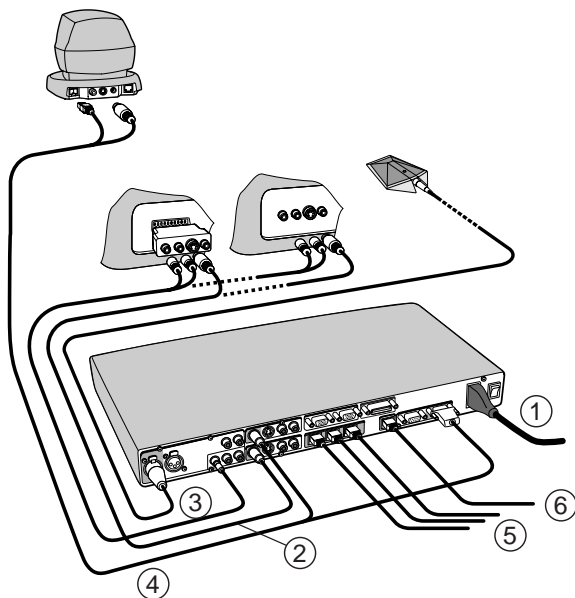

All cables needed in standard configuration are connected to the codec. Connect these cables to the other parts of the system:

1. Power cable

Connect the system power cable and monitor power cable to an electrical distribution socket.

2. Monitor cables

Connect the S-video cable to the input on your monitor (see drawing). For Scart-monitors, use the Scart-adapter.

3. Microphone cable

Connect the microphone cable to the microphone.

4. Camera cable

Connect the camera cable from the S-Video output on the camera to the S-Video input 'Main Cam' on the codec. Connect also the control cable between the RJ-45 on the camera, and the Dataport 1 on the codec.

NOTE SOME SOFTWARE VERSIONS DO NOT SUPPORT 3 ISDN LINES

5a. ISDN cables - using BRI interface

Connect the ISDN cables to the ISDN sockets (S/T-interface) provided by the service provider. Your main number will be the number associated with the socket to which ISDN cable number 1 is connected.

THE SYSTEM DOES NOT HAVE A BUILT-IN NETWORK TERMINATOR. IF YOUR WALL SOCKET PROVIDES YOU WITH AN ISDN U-INTERFACE, YOU WILL NEED AN NT1 BETWEEN YOUR SYSTEM AND YOUR ISDN LINE, SEE APPENDIX 1.

5b. Other networks - using the External Network interface

If you are using other networks, please refer to 'External Network Settings' and 'Appendix 2'.

6. LAN cable

- To use the system on LAN, connect a LAN cable from the 'Ethernet' connector on the system to your LAN.

Monitor configuration

Power on the monitor and use the monitor remote control to select the Audio/Video input used (refer to your monitor manual). Remember to select S-video (S-VHS) input to avoid a black and white picture.

TANDBERG/LOEWE 33"/29" (PAL) monitor

For the TANDBERG/LOEWE monitor external input 1 (199 AV1) is automatically selected.

If '199 AV1' is not selected, press the +/- buttons in front of the monitor until '199 AV1' is selected.

The monitor will automatically remember its last setting.

IMPORTANT: When switching on the monitor keep the button pressed for 2 seconds. The monitor will then start correctly (green light). If not, the monitor will only go to stand-by mode (red light).

If power is lost, the monitor will enter standby mode when it is connected to power again. Follow the procedure above.

System configuration

- Switch the system on by activating the power switch on the codec (located on the right hand side at the rear of the codec). A green light is shown (located in the center on the front of the codec).
- After the system has performed a self-test routine, product logo and a 'Welcome' menu will be displayed on the monitor.

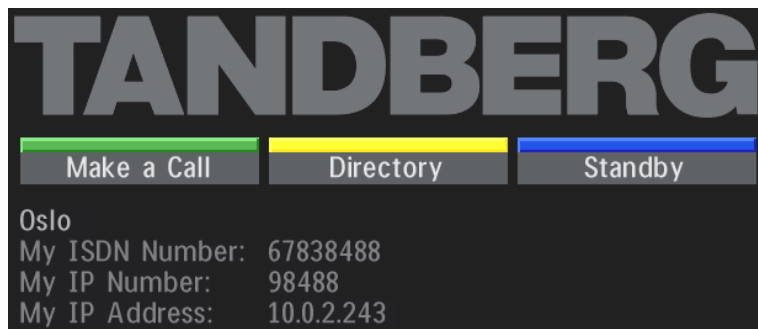

NOTE THESE SETTINGS ARE ESSENTIAL
FOR OPTIMAL SYSTEM SET-UP.

- Enabled but unused ISDN lines (lines not active) should be disabled. Select the Quick Key '**System Info**' (on the remote control) to view line status.

menu



PRESS **MENU** ON THE REMOTE CONTROL. SELECT THE MENU '**TERMINAL SETTINGS**', '**NETWORK**', '**ISDN-BRI SETTINGS**'. SELECT THE RELEVANT '**LINE SETUP**' MENU AND SET '**ENABLED: OFF**'.

- Enter System Name to identify the system during an MCU conference. Select '**Utilities**', '**System Name**' and enter the name using the number keys (as on a mobile phone).
- Select the language you want to use in '**Terminal Settings**', '**Language**'.
- If you are using two monitors, set '**Utilities**', '**Dual Monitor: On**'.
- To activate MultiSite and/or Presenter, enter an option key (see paperwork accompanying your system), see '**Terminal Settings**', '**Software Options**'.

connect



- Press **CONNECT** on the remote control. A dial tone should be heard if the network is active.
- Using the monitor remote control, adjust the volume on the monitor to a level of your choice. This volume will be the default volume for all calls.

ISDN configuration

For each installation of the system it is necessary to configure the unit. All configuration parameters are available via the menu system. If you are using an external IMUX or special networks, the external equipment may also need to be configured.

- Press **MENU** on the remote control. Select the menu '**Terminal Settings**', then '**Network**'.

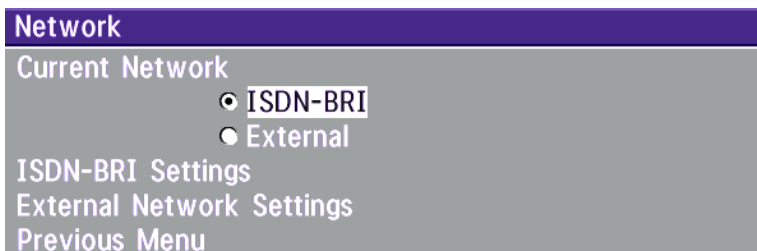

Set '**Current Network**' to the network you want to use.

Specify the settings for the selected network in one of the menus.

For details, follow the instructions in chapter 'Terminal Settings', 'Network Configuration' in this manual.

For further information refer to the examples in:

Appendix 1: Connecting the system to ISDN using NT1 network adapters

Appendix 2: Connecting the system to the Switched 56 network

LAN configuration

- Press **MENU** on the remote control. Select the menu '**Terminal Settings**', then '**LAN Settings**'.

LAN Settings

Streaming Settings

H.323 Settings

IP Settings

SNMP Settings

Previous Menu

Specify the necessary LAN settings according to the instructions from your LAN administrator. If there is an H.323 Gatekeeper present on your LAN, see also '**H.323 Settings**'.

For details, follow the instructions in chapter 'LAN Settings' in this manual.

Getting started

System start-up

Your system should be in standby mode. When in standby mode, pressing any key or picking up the remote control will wake up the system. An incoming call will also wake up the system.

If the system does not respond, make sure the system is switched on by using the On/Off switch located at the rear of the Codec (see figure below). After a few seconds you should see the 'Welcome' menu on the monitor.

If this does not help, verify that your monitor is switched on. To switch the monitor on you normally push the power button on the front of the monitor (depending on monitor type).

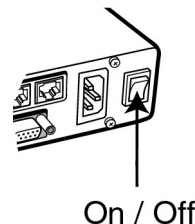

Welcome menu

After the system has performed a self-test routine, product logo and a 'Welcome' menu will be displayed on the monitor. This menu should provide you with the most important system information. The three color-coded commands shown correspond with the Quick keys on the remote control. This means that to make a call, you can press the green quick-key.

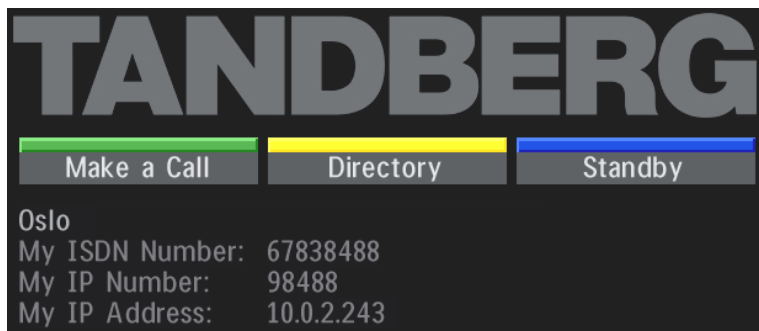

Basics

The system's most commonly used functions are accessible directly from the remote control by single key presses. In addition, the user interface is represented by on-screen menus. Individual items within the menus and lists can be selected by moving a white highlighter bar to the desired option.



Quick Keys

The three buttons on top of the remote control refer to the blocks at the bottom of the screen. The text inside the blocks will change depending on which menu is selected. The three Quick Keys have different colors.

Preset keys

Activate pre-stored camera positions.

Video source keys

Activate connected video sources.

Camera control and menu navigation keys

Frequently used keys allowing you to control your own camera and the far end camera, control your volume, select and move self-view, switch your microphone off and navigate in the menu system.

Dialing keys / Preset keys

Used to make a call. The twelve number keys, (0-9), #, * operate in the same way as on a modern push-button telephone. These buttons are also used when entering a name into a text field.

Making and ending calls

Making a call

 To make a call, enter the number or the IP-address of the unit you wish to call using the Dialing keys and press **CONNECT**.

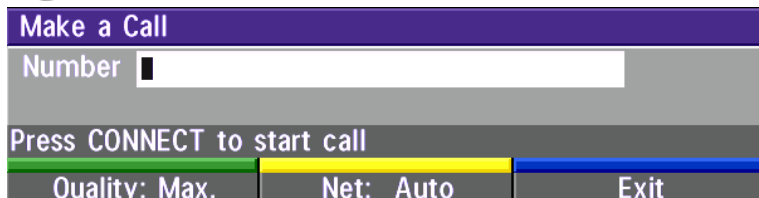

Make a Call		
Number <input type="text"/>		
Press CONNECT to start call		
Quality: Max.	Net: Auto	Exit

ISDN call

The system will, by default, try to connect using Quality: Auto (see table overleaf). If the requested quality (bandwidth) cannot be established, the system will establish a connection on as high quality as possible.

The SoftMux ensures high reliability and includes the unique Downspeeding feature. If channels are dropped during a meeting, Downspeeding automatically maintains the connection without interrupting the call in progress. The SoftMux also enables you to dial to other videoconferencing equipment, phones and mobile phones in the same way and provides you with on-screen, real-time feedback on the progress of a call.

LAN call

To make a call via a LAN, enter an IP-address by using a * as the 'dot' in the IP-address, e.g. 123*3*0*12 will be interpreted as 123.3.0.12. If a gatekeeper is present, you may place IP-calls using "telephone-style" numbers (an E.164 alias), according to the numbering plan implemented in the gatekeeper. The dialed number will then be translated into an IP-address by the gatekeeper.

Access Code

If the system requires an Access Code, enter the code and press OK to proceed making a call:

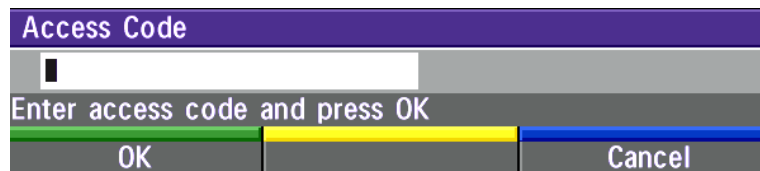

Access Code

Enter access code and press OK

OK Cancel

Using sub-address / extension address / MCU password

To specify an ISDN sub-address or its LAN equivalent extension address (TCS-4), add a star (*) after the number and then enter the sub-address/extension address.

Example: 12345678*10 (<number>*<Sub-address/extension address/MCU password>)

When calling to external MCU's requiring a password (TSC-1), this password can be added after the star (*). If no password is specified, a menu will prompt you to enter the password (after connected to the MCU).

TIP

SUB-ADDRESS IS USED TO ADDRESS DIFFERENT SYSTEMS ON THE SAME ISDN LINE.

TCS-4 IS USED TO ADDRESS DIFFERENT SYSTEMS ON A LAN, WHEN DIALING IN VIA A GATEWAY.

Selecting / setting default quality (bandwidth)

The default call quality setting '**Auto**' will be used if no specific quality is selected.

To select quality (bandwidth):

- Press the '**Quality**' Quick Key when you are in the dial menu. The Quality menu will then be displayed:

TYPE OF CALLS

Auto	384kbps on ISDN/768kbps on IP
Max	384kbps on ISDN/1536kbps on IP
1472	1472 kbps (IP only)
1152	1152 kbps (IP only)
768	768 kbps (IP only)
512	512 kbps (IP only)
384	384 kbps (6B)
320	320 kbps (5B)
256	256 kbps (4B)
192	192 kbps (3B)
128	128 kbps (2B)(Bonding/H.221)
64	64 kbps (1B)(H.221)
Teleph	Telephone Call

NOTE SOME SYSTEMS AND SOFTWARE VERSIONS AND NETWORKS DO NOT SUPPORT ALL BANDWIDTH SELECTIONS.

- Choose the preferred quality by selecting the desired call rate in the 'Call Rate' field.
- You may also press the '**Set as Default**' Quick Key in order to make the selected bandwidth the default bandwidth for subsequent calls.
- Set '**Set Restrict (56k)**' to 'On' to make a restricted call. An indicator '**(56k)**' will be shown behind the number.

TIP **RESTRICTED CALL** A RESTRICTED CALL IS A CALL TO A 56 KBPS NETWORK. BY DEFAULT THE SYSTEM WILL DIAL AN UNRESTRICTED CALL (A CALL TO A 64 KBPS NETWORK) AND DOWNSPEED TO 56KBPS IF NECESSARY. TO FORCE A RESTRICTED CALL, SELECT 'SET RESTRICT (56k)'

TIP **DIALING TWO NUMBERS**

SOMETIMES (ESPECIALLY WHEN CALLING TO AND WITHIN NORTH AMERICA) IT IS NECESSARY TO DIAL BOTH ISDN NUMBERS WHEN MAKING A VIDEO CALL USING 2x64 KBPS OR 2x56 KBPS. SELECT '**128**' IN THE QUALITY MENU. WHEN YOU RETURN TO THE DIAL MENU, BOTH '**NUMBER:**' AND '**2ND:**' ARE DISPLAYED. ENTER THE SECOND NUMBER.

Selecting / setting default network

To select a specific network, press the '**Net**' Quick Key when you are in the dial menu.:

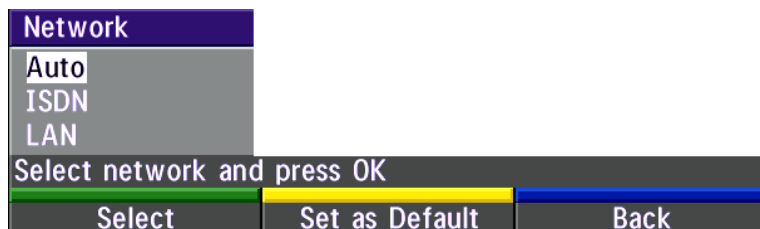

- 1 Highlight the network to be used in your call.
- 2 Press '**Select**' to select network or press '**Set as Default**' to set the selected network as your preferred choice for this and all subsequent calls.

If '**Auto**' is selected, the system will select a network based upon the following criteria:

- If an IP-address (e.g. 123*3*0*12) is entered, '**LAN**' (H.323) is selected.
- If the first digits in the number match those set in '**H.323 Prefix**' under '**H.323 Settings**', '**LAN**' is selected.
- In other cases, '**ISDN**' (H.320) is selected*.

If you want to assign a specific prefix to the network selection or if you want to define your own network configuration, see '**Network Profiles**' in '**Call Settings**', '**Terminal Settings**'.

* - ISDN indicates both ISDN-BRI and External Networks.

Answer a call

connect



To answer a call, press **C**ONNECT.

Manual answer of a call is needed if the autoanswer facility is switched off. See 'Utilities' in 'Advanced use'.

End a call

disconnect



To end a call, press **D**ISCONNECT.

TIP

ENDING A CALL: SWITCHING OFF THE MONITOR(S) WILL NOT DISCONNECT A CALL. TO DISCONNECT A CALL YOU SHOULD PRESS THE DISCONNECT KEY.

Correcting keying mistakes

delete



To delete the last digit (or character) entered, press **D**ELETE.

Directory

The directory is a local phone book that stores up to 100 directory entries including the last number dialed. The entries are sorted alphabetically. The entries can be point-to-point entries or MultiSite entries (see menu below). The MultiSite entries will not be displayed when you are in a call.

By using the dataport file system or external management systems like the TANDBERG Management Suite, it is possible to store 400 additional entries. These entries can only be changed from the dataport or the management system.

When the system receives an incoming call and the calling party's number is found in the directory, the calling party's name will be displayed instead of the number on the status line.

directory Press **DIRECTORY** to bring up the following menu:

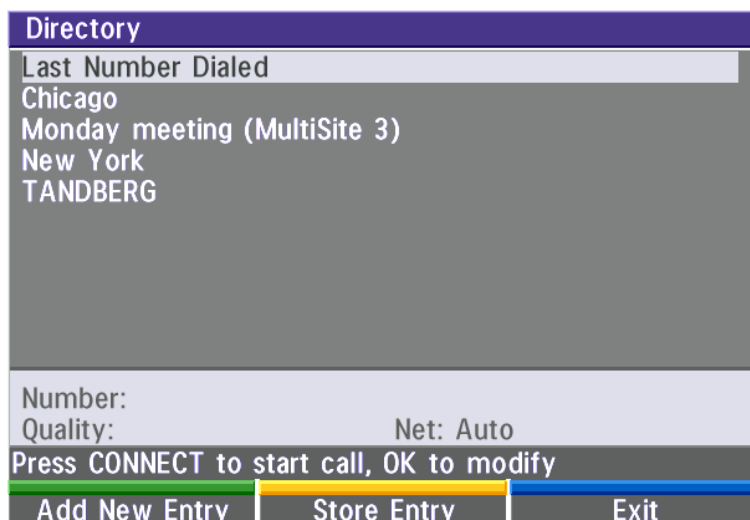

TIP WHEN LAST NUMBER DIALED IS HIGHLIGHTED, THE SECOND QUICK KEY STATES 'STORE ENTRY'. THIS MAKES IT POSSIBLE TO STORE LAST DIALED NUMBER.

To find an entry, key in the first letter, for example T, and scroll with the up/down arrows.

TIP THE LEFT/RIGHT ARROWS WILL MOVE ONE PAGE UP/DOWN.

connect To dial the selected entry press **CONNECT**. To edit the selected number before dialing, press **OK** (only point-to-point entries).



Add New Entry

When selecting '**Add New Entry**', an empty directory entry is displayed:

The screenshot shows a menu titled "Add New Entry" with the following items:

- Name: A text input field with a cursor.
- Number: A text input field.
- Quality: A dropdown menu showing "Max." with a right-pointing arrow.
- Set Restrict(56k): Two radio buttons, "On" and "Off", with "Off" selected.
- Net: A dropdown menu showing "Auto" with a right-pointing arrow.
- Save: A button.

Below the menu is a prompt: "Press # to switch a/A, OK to save changes". At the bottom are three buttons: "Save", "Add MultiSite", and "Cancel".

- 1 Move to '**Name**' and enter characters using the number keys on your remote control (as on mobile phones). Use '0' to enter 'space', use '#' to switch between upper- and lower case.
- 2 Move to '**Number**', key in the number and press **OK**. Specify only one number. If two numbers are required, both numbers should be specified (2x64 or 2x56 calls).
- 3 Select '**Quality**' to specify call rate to be used.
- 4 Select '**Set Restrict(56k)**' to 'On' to restrict the call rate. (A restricted call is a call to a 56Kbps network).
- 5 Select '**Net**' to specify the network profile to be used. See 'Selecting / setting default network'.
- 6 Select '**Save**' to save the entry and return to the Directory menu.

Delete Entry

When '**Delete Entry**' is pressed, the selected entry is deleted.

Edit Entry

To edit an entry, highlight the entry you want to edit and press '**Edit Entry**'. Edit the entry and select '**Previous Menu**' to return to the Directory menu.

Delete Entry

To delete an entry, highlight the entry and press **DELETE**.

Add MultiSite Entry

When selecting '**MultiSite Entry**', an empty MultiSite directory entry is displayed:

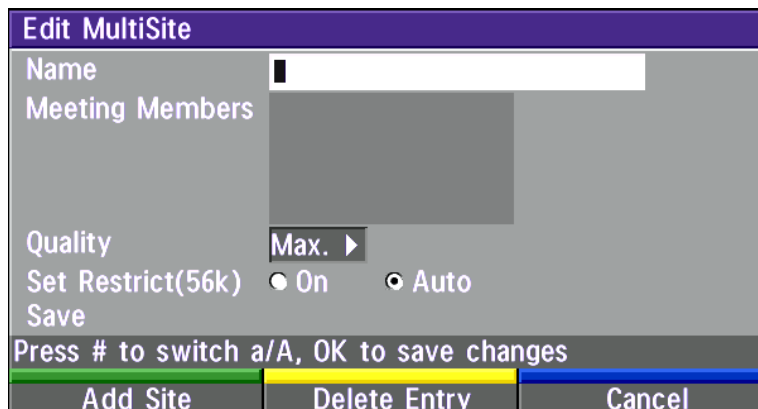

- 1 Move to '**Name**' and enter the MultiSite meeting name.
- 2 Select '**Add Site**' to add a site to the meeting by searching for point-to-point entries in the directory list. See below for details.
- 3 Select '**Quality**' to override the suggested bandwidth per site.
- 4 Select '**Set Restrict(56k)**' to 'On' if a restricted call shall be made (A restricted call is a call to a 56Kbps network).

QUALITY PER SITE: AUTO, FUNCTIONALITY

TIP

EXAMPLE: THE SYSTEM HAS MAXIMUM CAPACITY 512KBPS. TWO ENTRIES ARE ADDED, ONE WITH 384KBPS AND ONE WITH 128KBPS.

1) SINCE ALL SITES MUST USE THE SAME BANDWIDTH, QUALITY PER SITE WILL BE 128KBPS.

2) IN ADDITION, MAXIMUM BANDWIDTH PER SITE CANNOT EXCEED THE TOTAL BANDWIDTH AVAILABLE DIVIDED BY THE NUMBER OF SITES. IN THIS CASE, THE MAXIMUM BANDWIDTH PER SITE CANNOT EXCEED $512/2=256$ KBPS. IF THE BANDWIDTH IN 1) IS HIGHER THAN THIS BANDWIDTH, THE 'QUALITY PER SITE' SETTING MUST BE REDUCED TO CORRESPOND WITH THE TOTAL CAPACITY OF THE SYSTEM.

- 5 When finished, select '**Save**' to save the MultiSite entry.

Add Site

Highlight the entry you want to add to the meeting and press **Ok**. If you do not find the entry you need, select '**Add New Entry**' to add an new point-to-point directory entry.

NOTE GLOBAL ENTRIES WILL NOT BE AVAILABLE FOR FOR MULTI SITE ENTRIES.

General use

Adjusting volume



Press the **VOLUME** keys to adjust the volume level. An on-screen indicator will show the current level.

View outgoing video (selfview)

selfview



Press the **SELFVIEW** key to view your outgoing video.

To change the image being viewed on the monitor during a call press **SELFVIEW** until the desired image is shown (far end/selfview/still image or Duo Video).

move pip



Press **MOVE PIP** to move your selfview as a Picture-in-Picture to different corners of the screen or to switch it off.

Microphone on/off

mic off



To mute your microphone during a call, press **Mic OFF**. An on screen indicator will appear when the microphone is off. In a call, if audio is detected, the on-screen symbol will start to flash. Pressing **Mic OFF** one more time will activate the microphone again.

NOTE **Mic OFF** WILL MUTE AUDIO INPUTS **Mic1-3** AND **AUDIO4**. IT WILL NOT MUTE AUDIO FROM THE **AUX** AND **VCR** INPUTS.

On Screen Symbols

The system has a number of symbols signalling different settings



This symbol will be shown when the volume is turned off on the system.



This symbol will be shown when the microphone is muted/turned off. It will also start to flash if audio is detected in the room during a call.



This double padlock symbol will be shown when AES* encryption (Secure Conference) is active.



This padlock symbol will be shown when DES encryption (Secure Conference) is active.



This open padlock symbol is shown during the initialization phase for encryption. During this period the call is not secure.



When the system is On Air in a Multisite conference, this symbol will be shown.

Do Not Disturb / Sleep Mode

Press any Quick key when not in a call to activate the Quick Menu.



When Do Not Disturb is activated, the system will not accept any incoming calls. The caller will hear a busy tone when calling this unit. A status line will indicate when Do Not Disturb is active.

* Optional feature

When Sleep Mode is selected, the following quick-keys are displayed:



Pressing '**Sleep Now**' puts the monitors in sleep mode. The system will still accept incoming calls.

Pressing '**60 Minutes**' or '**3 Hours**' will delay entering sleep mode accordingly.

Pressing any key or picking up the remote control will deactivate Do Not Disturb/Sleep Mode.

Controlling the Main Camera

Moving / zooming camera

To control the Main Camera use the keys below:



for pan/tilt and



for zooming.

NOTE IF THE MENU SYSTEM IS ACTIVE, THE ARROW KEYS WILL NAVIGATE IN THE MENU.

Focusing camera

The Main Camera is set to autofocus by default. If the Main Camera is moved (pan/tilt/zoom), autofocus will be switched On automatically for 5 seconds.

To manually focus the Main Camera, see 'Video Settings' in 'Advanced use'.

Selecting video sources

Press: to select the video source to be transmitted to the far end.



NOTE WHEN SELECTING THE DOC CAM OR PC VIDEO SOURCES THE SYSTEM WILL AUTOMATICALLY REQUEST FLOOR WHEN CONNECTED TO A MCU CONFERENCE AS MULTISITE HOST OR CONNECTED TO AN EXTERNAL MCU. THIS FEATURE CAN BE SWITCHED OFF IN THE PRESENTATIONS MENU.

Voice Activated Camera Positioning

Through Voice Activated Camera Positioning and the use of two microphones, the camera will automatically view the current speaker.

Setup

Before using camera tracking, the camera positions used must be stored at presets P7 (Mic1) and P8 (Mic2).

EXAMPLE: THE CAMERA POSITION STORED AT P7 MUST BE RELATED TO MIC1, THEREFORE ALL PARTICIPANTS WHO ARE LOCATED CLOSEST TO MIC1 SHOULD BE INCLUDED IN THE P7 CAMERA POSITION ETC. WHEN CAMERA TRACKING IS ACTIVATED AND A PERSON CLOSE TO MIC1 SPEAKS, P7 WILL BE AUTOMATICALLY SELECTED.

Activating

presets



Enable Camera Tracking by pressing '**CamTrack On**' in the '**Preset 0-9**' menu, which is activated by pressing the **P** button on the remote control. An on-screen indicator '**CamTrackOn**' will appear.

When activating another video source (e.g., document camera), camera tracking will be temporarily disabled until you re-select MainCam or a MainCam preset.

mic off



Pressing **Mic Off** will temporarily disable camera tracking.

A Voice Detector makes the system more tolerant of noise and ensures the camera not to be moved by noise such as paper shuffling, etc.

Deactivating

Disable Camera Tracking by:

- moving the camera manually.
- activating a MainCam preset when MainCam is already activated.
- disconnecting the call.

An on-screen indicator '**CamTrackOff**' will appear.

TIP THE CAMERA TRACKING SPEEDS MAY BE ALTERED IN THE 'VIDEO SETTINGS' MENU. SEE 'ADVANCED USE' FOR FURTHER DETAILS.

Presets

The preset buttons enable you to pre-store up to ten different settings. Each preset is able to store:

- Video source
- Camera position, pan/tilt/zoom/focus/brightness (if Main Camera)
- Audio source selection (see 'Audio Settings' in 'Advanced use')

Selecting presets

To select a pre-stored camera position, audio and video source, use the keys **P1 P2 P3** or press **P** until the on-screen indicator '**Preset 0-9**' appears and use 0-9 to activate P0-P9 presets. To exit 'Preset' mode, press **Ok**.



P1-P3 are the same presets as when pressing **P** and then a number key **1-3**.

Storing presets

To store the current camera position, audio and video source:



- Press **STORE** once and wait for the on-screen indicator to appear.
- Then press one of the keys **P1 P2 P3** or a number key **0-9**.

Storing preset 10 to 15

To store preset 10-15 the TANDBERG Tracker has to be used:

- Select which preset to be used on the TANDBERG Tracker (see separate documentation).
- Press **STORE** once on the TANDBERG Remote Control and wait for the on-screen indicator to appear.
- Then press the 'single person' button on the TANDBERG Tracker.



See the Tracker section in 'Peripheral Equipment' for more information about the TANDBERG Tracker.

Far end camera control (FECC)

far end



Press the **FAR END** key until the '**FarEndCamera**' on-screen indicator is displayed.

For this feature to operate the far end must support 'Far end camera control' (H.281).

While activated you will be able to control the far end's camera (pan/tilt/zoom/focus) and presets.

To control the far end camera use the keys below:



for pan/tilt and



for zooming.

Far end presets can be activated by pressing the keys **P1 P2 P3** or the number keys **0-9** to activate presets P0-P9.

Selection of far end videosources is achieved by pressing the buttons below when in FarEndCamera mode:



NOTE IT DEPENDS ON THE FAR END SYSTEM CONFIGURATION IF THE FAR END DOCUMENT CAMERA IS DISPLAYED WHEN **Doc Cam** IS PRESSED.

To prevent others controlling your camera, select '**Far End Camera Control:Off**' in '**Utilities**'.

Sending and receiving snapshots

When a snapshot is sent, received or requested, it will be stored in the graphics memory. When a new image is sent or received, the old image will be erased. When disconnecting the call, the image will be erased.

Sending a snapshot

snapshot • Press **SNAPSHOT**.



• To send a snapshot from another video source (e.g. the document camera), select source:



• Press **SNAPSHOT**.

NOTE WHEN IN A MCU CONFERENCE AS MULTISITE HOST OR CONNECTED TO AN EXTERNAL MCU, SENDING A SNAPSHOT WILL AUTOMATICALLY INITIATE A FLOOR REQUEST.

TIP SEE 'PRESENTATIONS' MENU FOR AUTOMATIC SETUP OF THIS OPERATION.

Viewing a snapshot

The last sent or received snapshot will automatically be displayed on your screen.

• Press **SELFVIEW** to return to normal view.

NOTE REQUIRES 'AUTO-DISPLAY SNAPSHOT: ON' IN 'PRESENTATIONS'

Receiving a snapshot

A received snapshot will automatically be displayed on your screen.

• Press **SELFVIEW** to return to normal view.

NOTE REQUIRES 'AUTO-DISPLAY SNAPSHOT: ON' IN 'PRESENTATIONS'

Requesting a snapshot

• Press **FAR END** until the 'FarEndCamera' on screen indicator is displayed.

• Press **SNAPSHOT**. A snapshot from the far end is automatically displayed.

Duo Video *

Duo Video is useful if you want to display live video from your document camera or another camera in addition to live video of yourself.

Add Duo Video

- Alt.1: Press any other video source than MainCam during a call. This will open Duo Video directly if the far end supports the automatic Duo Video functionality (requires also '**Duo Video Mode: Auto**' in '**Presentations**').
- Alt.2: To open Duo Video (also older versions of Duo Video), press **CONNECT** during a call. This will bring up the following menu:

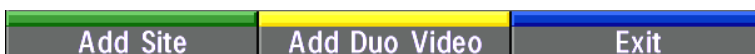

- Select '**Add Duo Video**'. The following menu will be displayed:

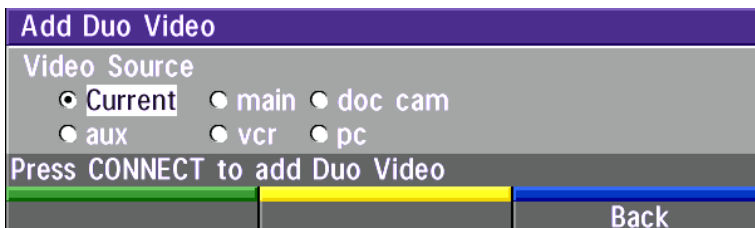

- Select video source to transmit on Duo Video.

- Press **CONNECT** to add Duo Video.

NOTE **AUTOMATIC DUO VIDEO** HANDLES DUO VIDEO WITHIN THE SAME CALL. IT IS NOT NECESSARY TO MAKE A NEW CALL AND THE CONNECT TIME DECREASES A LOT. DUO VIDEO BORROWS BANDWIDTH FROM THE MAIN CONNECTION. WHEN DUO VIDEO IS CLOSED, THE BANDWIDTH IS RETURNED TO THE MAIN CONNECTION. THIS DUO VIDEO IS ALSO UNI-DIRECTIONAL AND HENCE, EASIER TO USE. WHEN IN AN MULTISITE CALL, THE MULTISITE CAN TRANSMIT THIS DUO VIDEO TO THE OTHER PARTICIPANTS SUPPORTING THIS DUO VIDEO VERSION.

NOTE IF THE FAR END SUPPORTS DUO VIDEO, BUT NOT THE AUTOMATIC DUO VIDEO, PRESS 'QUALITY' TO SELECT EXTRA BANDWIDTH TO BE USED BY DUO VIDEO. AN EXTRA CALL WILL BE MADE AND DUO VIDEO WILL NOT BORROW BANDWIDTH FROM THE MAIN CONNECTION.

* - Optional feature.

End a Duo Video call

disconnect



To end a Duo Video call, press **DISCONNECT**. Select if you want to disconnect only the Duo Video connection or the whole connection.

Controlling camera, changing video source, presets in a Duo Video call

The main monitor will always display incoming video. The 2nd monitor will display outgoing video (Duo Video in full screen / Main local video in PIP).

Pressing **SELFVIEW** will toggle Duo Video full screen / Main source in PIP and vice versa. Pressing **SELFVIEW** will not change anything on the main monitor in a dual monitor setup.

Pressing **MOVE PIP** will move PIP only on the 2nd monitor in a dual monitor setup.

Controlling the camera, changing video source and using presets will affect the video source currently displayed in full screen mode.

EXAMPLE: IF DUO VIDEO IS SHOWN IN FULL SCREEN ON THE 2ND MONITOR, PRESSING ANY OF THE VIDEO SOURCE BUTTONS WILL CHANGE DUO VIDEO SOURCE. IF THE MAIN CONNECTION IS SHOWN IN FULL SCREEN, PRESSING ANY OF THE VIDEO SOURCE BUTTONS WILL CHANGE THE MAIN CONNECTION SOURCE.

If both connections are selected to display the same video source, Duo Video will be closed.

MultiSite (MCU)*

The system has a built-in multipoint conference unit (MCU), MultiSite, which has the capability to establish meetings with up to 4 video sites (5 if at least one site is a telephone call, ISDN/analogue/mobile).

The video calls in a conference must be connected using the same bandwidth.

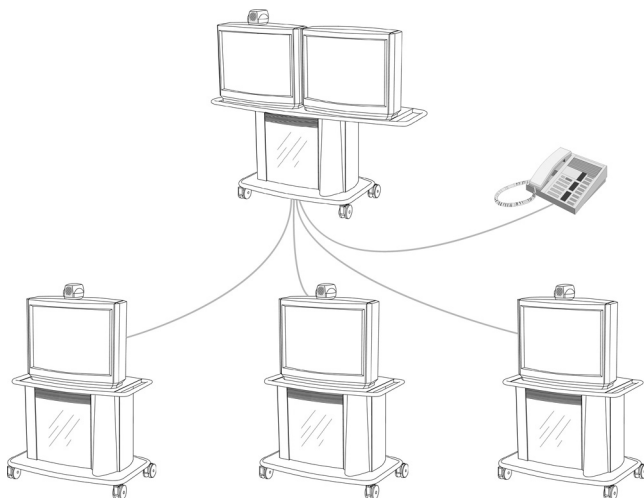

A conference can consist of any combination of ISDN/ LAN sites.

It is possible to have telephone meetings with up to 5 participants.

The MultiSite supports both Voice Switched and Continuous Presence mode (see 'MCU Services' in 'Advanced use' for description of these modes).

Establishing a conference is done by first making a call to one site. When a call is established with the first site, the other sites are connected one by one.

It is possible to either dial out to the sites or the sites can dial in to the MultiSite.

Both ISDN, IP and mixed ISDN/IP conferences can be encrypted if all systems supports encryption.

TIP SEE 'UTILITIES', 'CONTINUOUS PRESENCE' TO CHANGE MODE.

For encrypted calls, there is also a maximum bandwidth of 768 Kbps for the whole conference. This means that a 3 site conference will have a maximum bandwidth of 384Kbps per connection, while a 4 site conference will have a maximum bandwidth of 256 Kbps per connection.

NOTE THE SYSTEM SUPPORTS MIXED MULTI SITE WITH V.35 AND IP, BUT THE IP SITE MUST BE ADDED AFTER THE V.35 IS UP AND RUNNING.

MULTISITE - WHICH QUALITY CAN BE USED ON EACH SITE?

BANDWIDTH	NO OF SITES	
	4 SITES	3 SITES
768 KBPS	256	384
1152 KBPS	384	512
1536 KBPS	512	768

NOTE - 4 SITES INDICATES YOURSELF + THREE OTHER SITES.

* - Optional feature.

MultiSite cascading

By connecting four MultiSite systems together, it is possible to connect up to 10 video sites (including the four MultiSite sites) plus 4 audio sites (telephones), see drawing below.

The host can connect up to 3 other video systems with MultiSite functionality. The host can use Voice Switched or Continuous Presence mode.

The cascaded systems connect to two other video sites plus one audio site each. These systems will automatically run Voice Switched mode and transmit a full screen image to the host.

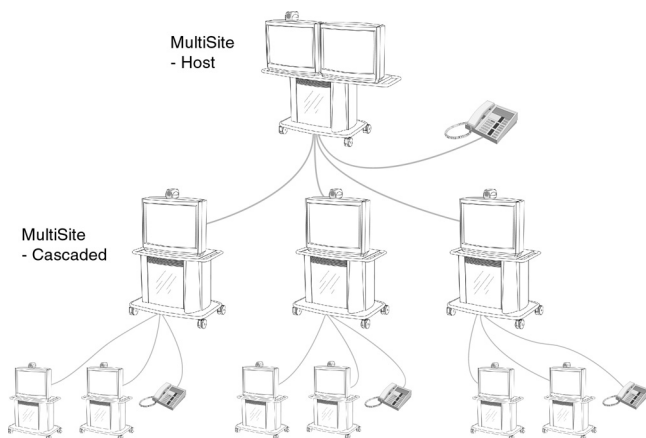

NOTE ALL CONNECTIONS CAN BE ANY COMBINATION OF ISDN/IP.

Establishing MultiSite meetings using Directory

It is possible to pre-define meetings using the Directory. All sites will then be connected automatically instead of having to add sites one by one.

- Press **DIRECTORY**.
- Highlight a MultiSite entry and press **CONNECT**.

See 'Directory' section for further information.

Adding an extra site - dial out

First establish a normal point-to-point call. It is recommended to plan the bandwidth usage before making the first call so that you do not run out of bandwidth.

EXAMPLE: IF THE SYSTEM HAS 512KBPS AVAILABLE AND YOU WANT TO CONNECT 3 SITES IN ADDITION TO THE HOST, 128KBPS SHOULD BE SELECTED FOR THE FIRST CALL. THE SYSTEM WILL THEN AUTOMATICALLY USE 128KBPS WHEN CONNECTING THE OTHER SITES.

When the first site is connected, add a site to the conference using the following procedure:

connect



- Press **CONNECT** to bring up the following menu:

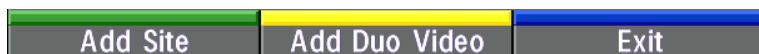

- Press '**Add Site**' to bring up the MultiSite dial menu.

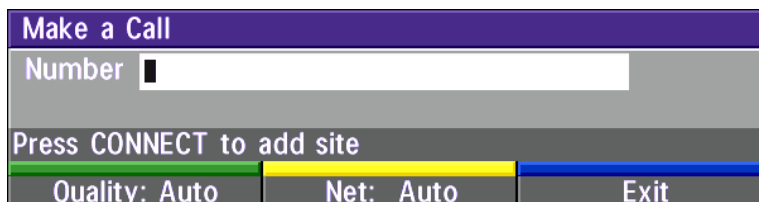

- Enter the number to call.

The Quality will, by default, be the same as used by the first call. To place a telephone call instead of a video call, press '**Quality**' and select '**Teleph**' in the Quality menu.

To use another network operator, press '**Net**' and select operator in the Net menu.

connect



- Press **CONNECT**

NOTE IF THE MULTISITE SYSTEM DOES NOT HAVE ENOUGH BANDWIDTH TO ADD ANOTHER SITE, THE SYSTEM WILL AUTOMATICALLY DOWNSPEED TO ALLOW AN ADDITIONAL SITE TO BE ADDED TO THE CONFERENCE. REQUIREMENT: FAR END MUST SUPPORT DOWNSPEED AND MUST HAVE ENOUGH BANDWIDTH.

TIP CONNECT THE SYSTEM WITH THE LOWEST BANDWIDTH FIRST IN ORDER TO OPTIMIZE CONNECTION TIME.

TIP IT IS POSSIBLE TO CONNECT SEVERAL TELEPHONES, E.G. 2 VIDEO SYSTEMS + 3 TELEPHONES (A TOTAL OF 5 SITES).

Adding an extra site - dial in

To dial in to the MultiSite on **ISDN-BRI**:

- Site 2 must dial MultiSite Number 2.
- Site 3 must dial MultiSite Number 3.

TIP TO FIND THE DIAL-IN NUMBERS FOR THE MULTISITE, PRESS '**MENU**' AND '**SYSTEM INFO**'

To dial in to the MultiSite on **ISDN-PRI**:

- Dial the main number of the system ('**My ISDN Number**'). All sites can dial the same number.

To dial in to the MultiSite on **IP**:

- Dial the IP Number or the IP Address of the system ('**My IP Number**'/'**My IP Address**').

When the MultiSite receives an incoming call, the following menu is displayed:



- Pressing **CONNECT** is equivalent to pressing '**Accept**'.
- Pressing **DISCONNECT** is equivalent to pressing '**Reject**'.
- Pressing '**Do Not Disturb**' will disable the MultiSite from answering more incoming calls during the current conference. The calling party will receive a busy signal.

Disconnecting sites from a conference

disconnect To disconnect a site or end the conference, press **DISCONNECT**.



- Select site and press **Ok** or '**Disconnect Site**'.

To end the meeting press '**Disconnect All**'.

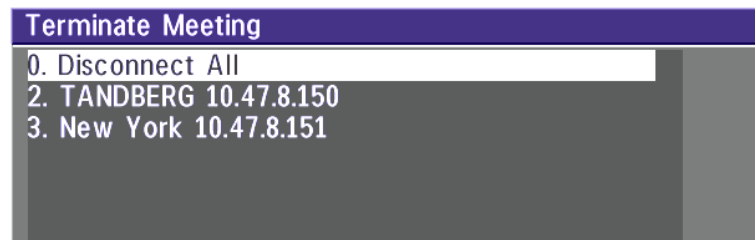

NOTE EACH SYSTEM WILL BE IDENTIFIED BY A SYSTEM NAME (IF SUPPORTED) AND THE NUMBER OF THE FAR END.

PC Presenter

Plugging a PC into the system is made extremely simple through the PC Presenter, avoiding the need for any additional hardware such as a projector, PC/Video converter or extra cables.

- Connect a VGA-VGA cable from your PC (VGA Output) to 'VGA In' on your system.
- Start your PC.
- Press **PC** on your remote control.
- Press **SELFVIEW** until the indicator 'Selfview' is displayed on your main monitor (single monitor system) or until you see the PC image on the second monitor.

If no PC image is displayed on your monitor, make sure that your PC transmits the image to the VGA Output, and that the PC transmits a supported VGA-format (see tip below). Consult your PC-operating manual to see how to transmit a VGA image from your PC (typically: Fn+F5).

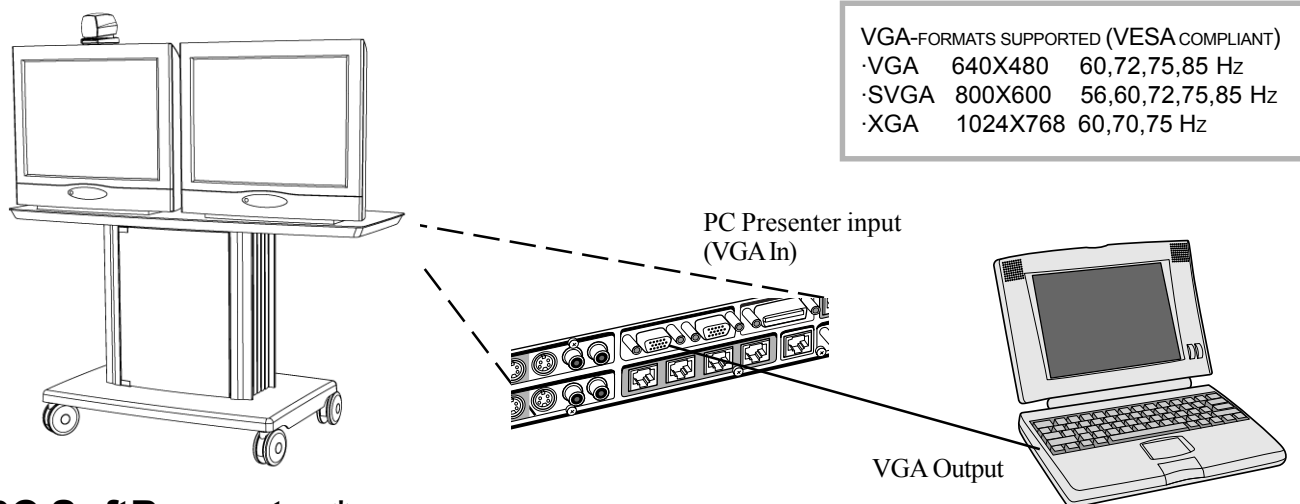

PC SoftPresenter *

PC SoftPresenter is used to display PC images on your system without using a VGA cable. The TANDBERG video conferencing system and your PC must be connected to a LAN. In addition, VNC (Virtual Network Computing) server software must be installed on the PC.

To show the PC image:

- Start the VNC software on your PC.
- Press **PC** on your remote control. Use UP/DOWN to activate PAGE UP/PAGE DOWN on the PC.

For setup information and details, see 'VNC Settings' in 'Advanced use'.

NOTE 'PC: VNC' MUST BE SET IN 'VIDEO SETTINGS'.

* - Optional feature.

Web-interface

It is possible to access and maintain the system remotely via a local area network (LAN) using a standard Web-browser.

Connect your system to a local area network.

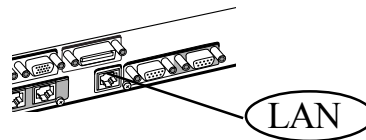

Configure your codec:

- Press MENU, select '**Terminal Settings**', '**LAN Settings**'
- Specify IP-assignment '**DHCP**' or '**Static**'. If DHCP is selected no other settings are needed. If Static is selected, '**IP-address**', '**IP-subnet mask**' and '**Gateway**' must be specified.

Example:

IP-assignment:	Static
IP-address:	196.9.200.129
IP-subnet mask:	255.255.255.0
Gateway:	196.9.200.21

NOTE THE SYSTEM MUST BE RESTARTED BEFORE CHANGES IN THE '**LAN SETTINGS**' MENU CAN TAKE EFFECT.

See 'LAN Settings' in 'Advanced use' for further information.

- Start your Web-browser. In the address field type the IP-address of the codec. Enter the password and the Web-page of the codec will be shown. The default password is '**TANDBERG**'.

Text Chat / Closed Captioning

While in an ISDN or IP call to another system supporting Text Chat (T.140), select 'Text Chat' from the Web-page of the codec. Enter text in the window displayed. When selecting 'Send Text', the text will be displayed on the local and far-end monitor as shown below:

Text from far end site

Text from local site

The local Text Chat window can be closed manually from the Web-interface by pressing 'Close Window'. It will also close automatically after a few minutes without activity.

Streaming

To view streaming, select 'Streaming' from the Web-page of the codec. See separate 'Streaming' section in this manual for further information.

Snapshots

Snapshots of current stream (if MultiSite), selfview, far end and DuoVideo streams are accesible via http. See Appendix 5 for descriptions of the possible snapshot files.

T.120 and other PC applications*

A PC can be connected to the system using a serial cable. This will enable interactive editing, file transfer and application sharing between two computers.

Appropriate communication software should be used (for example: Microsoft NetMeeting, Intel ProShare Premier, Windows HyperTerminal, Procomm Plus and so forth.)

The system has been specially designed to work with interactive programs and includes a data channel that can send and receive data to and from the far end at speeds of up to 38,400 baud.

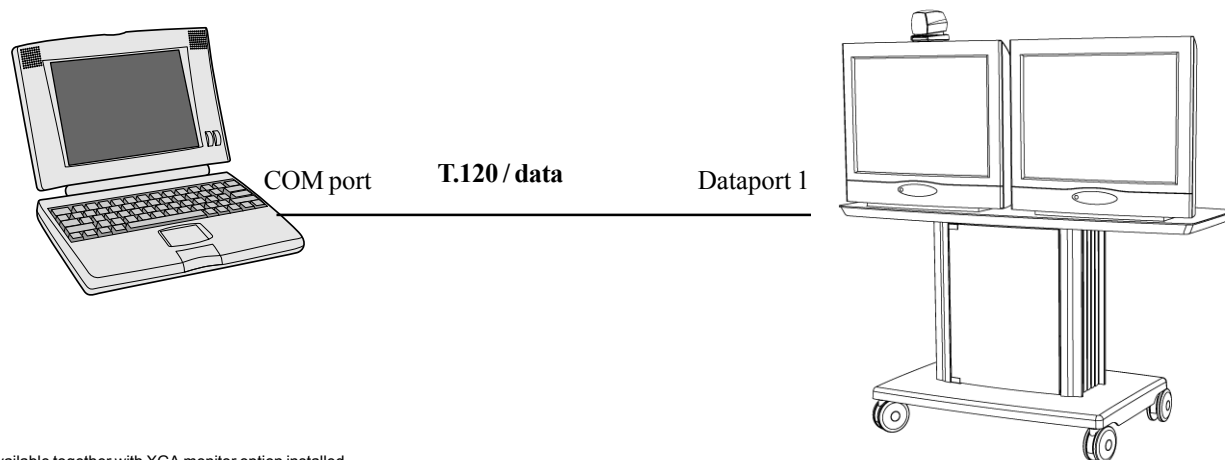

* - Not available together with XGA monitor option installed

Advanced use

Main menu

The menu system can be used to select available functions and utilities for the system.

menu



To enter the menu system and the main menu, press the **MENU** key. You may leave the menu system at any time by pressing the **MENU** key.

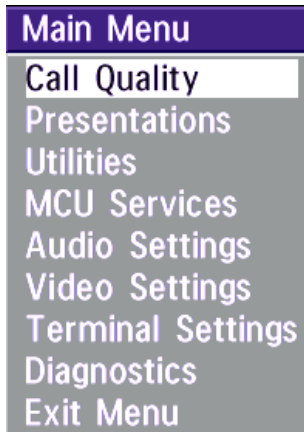

TIP A MENU STRUCTURE MAP IS PROVIDED IN THE SECTION 'MENU STRUCTURE' AT THE FRONT OF THIS MANUAL.

NOTE IN THE FOLLOWING MENU DIAGRAMS THE DEFAULT SETTINGS ARE HIGHLIGHTED.

Menu Password

It is possible to password protect the menus on the TANDBERG system. To activate this feature, specify a Menu Password in the Utilities menu. By doing this, only dialing and camera control commands will be available. When pressing the **MENU** key, the user will be asked to enter the Menu Password as can be seen below.

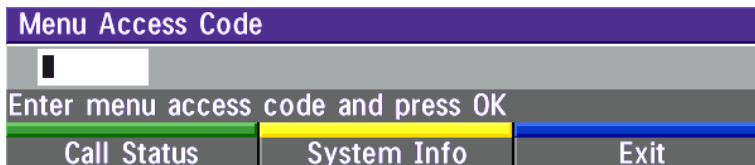

Call quality

The Call Quality menu allows you to select the preferred quality of your call.

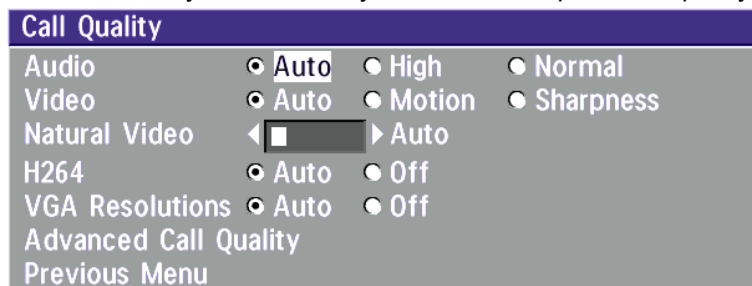

NOTE DUE TO ACTIONS OR LIMITATIONS AT THE FAR END YOU MAY NOT ALWAYS BE ABLE TO ACHIEVE THE SELECTIONS YOU WANT.

Audio

Auto Optimized audio quality depending on bandwidth.
 High High audio quality (G722) regardless of bandwidth.
 Normal Telephone quality (G728) regardless of bandwidth.

TIP **Auto**
 1-4 CHANNELS: G722.1 IS SELECTED.
 5 OR MORE CHANNELS: G722 IS SELECTED.

Video*

Auto Will select 'Motion' or 'Sharpness' depending on selected video source**.
 Motion Optimized for smooth motion video for all video inputs.
 Sharpness Optimized for sharp video for all video inputs.

Natural Video

Choose at what level Interlaced video capabilities (iCIF) will be transmitted and enabled. When set to

'Auto' Natural Video will be transmitted from 768Kbps.
 'Off' Interlaced capabilities will not be transmitted. This is useful if far end cannot handle these

H.264***

Auto Optimized video quality depending on what is available.
 Off H.264 video compression and decompression will not be used.
 capabilities.

VGA Resolutions

Auto VGA capabilities (VGA/SVGA/XGA***) and SIF capabilities will be transmitted and enabled.
 Off VGA capabilities will not be transmitted. Useful if far end can not handle these capabilities.

TIP SIF CAPABILITIES WILL ENABLE BETTER VIDEO QUALITY FOR NTSC SYSTEMS (SIF: 352x240, ISIF: 352x480, 4SIF: 704x480).

* - If option 'Presenter' is not installed or if H263 is not used, only CIF resolution will be used for all selections.

** - MainCam/Aux/VCR will select 'Motion'. DocCam/PC will select 'Sharpness'.

*** - E2 only

Advanced call quality

Advanced Call Quality	
Audio	<input checked="" type="radio"/> Auto <input type="radio"/> G722.1 <input type="radio"/> G722 <input type="radio"/> G728 <input type="radio"/> G711 <input type="radio"/> Off
Video	<input checked="" type="radio"/> Auto <input type="radio"/> H264 <input type="radio"/> H263 <input type="radio"/> H261 <input type="radio"/> Off
Resolution	<input checked="" type="radio"/> Auto <input type="radio"/> 4CIF <input type="radio"/> CIF <input type="radio"/> QCIF
H331	<input checked="" type="radio"/> Off <input type="radio"/> On
Status Format	<input checked="" type="radio"/> Auto <input type="radio"/> Advanced
Previous Menu	

NOTE THE 'AUTO' SETTINGS ARE RECOMMENDED CHOICES FOR MOST CASES. THE OTHER AUDIO, VIDEO AND RESOLUTION SELECTIONS MADE IN THIS MENU WILL OVERRIDE THE SELECTIONS MADE IN THE 'CALL QUALITY' MENU AND ARE **NOT** RECOMMENDED TO BE CHANGED FOR NORMAL USE.

Audio

Auto	The setting of 'Audio: Auto/High/Normal' in 'Call Quality' will be used.
G.722.1	Compressed high quality audio (7 kHz).
G.722	High quality audio (7 kHz).
G.728	Compressed normal quality audio (telephone quality, 3.1 kHz).
G.711	Normal quality audio (telephone quality, 3.1 kHz).
Off	No audio is transmitted.

Video

Auto	Optimized video quality depending on available bandwidth.
H.264**	Bandwidth efficient video compression and decompression.
H.263	Normal video compression and decompression.
H.261	Legacy video compression and decompression.
Off	No video is transmitted.

Resolution

Auto	The setting of 'Video: Auto/Motion/Sharpness' in 'Call Quality' will be used, see tip above.
4CIF *	Digital Clarity (704 x 576 pixels), only for H263.
CIF	High resolution video (352 x 288 pixels).
QCIF	Low resolution video (176 x 144 pixels).

H.331

Off	Standard two-way communication with quality negotiation between both sides.
On	Used when broadcasting a video conference from one site to many others, e.g. via satellite, where there is no possibility to negotiate quality between the receivers and the originator due to one-way communication.

Status Format

Provides call quality feedback on the status line.

Auto	Video off/on, Audio off/normal/high
Advanced	Shows video/audio standards (Example: Video: H261 CIF, Audio: G722).

TIP **RESOLUTION, AUTO FUNCTIONALITY**
(IF SUPPORTED BY FAR END):
WHEN 'VIDEO: MOTION' :
LOW BANDWIDTHS: CIF, SIF
HIGH BANDWIDTHS: ICIF, ISIF
WHEN 'VIDEO: SHARPNESS' :
4CIF, 4SIF, VGA, SVGA, XGA**

* - Requires option 'Presenter'. To check which options are installed, see the 'System Info' menu in 'Diagnostics'.

** - E2 Only

Presentations

Presentations			
Presentation Mode	<input checked="" type="radio"/> Normal	<input type="radio"/> Preview	
Duo Video Quality	<input checked="" type="radio"/> Auto	<input type="radio"/> Motion	<input type="radio"/> Sharpness
Duo Video Mode	<input type="radio"/> Auto	<input checked="" type="radio"/> Manual	
Duo Video Number	<input checked="" type="radio"/> Auto	<input type="radio"/> Manual	
Duo Video / Snapshot Source			
	<input type="radio"/> Current	<input type="radio"/> main cam	<input type="radio"/> aux
	<input checked="" type="radio"/> doc cam	<input type="radio"/> vcr	<input type="radio"/> pc
Auto-Display Snapshot	<input type="radio"/> Off	<input checked="" type="radio"/> On	
Snapshot Filter	<input type="radio"/> Off	<input checked="" type="radio"/> On	
Auto Request Floor	<input type="radio"/> Off	<input checked="" type="radio"/> On	
Previous Menu			

Presentation Mode

To send a snapshot immediately after pressing **SNAPSHOT** select '**Presentation Mode: Normal**'.

To preview the image before it is transferred as a snapshot, select '**Presentation Mode: Preview**'. When pressing **SNAPSHOT** you will be allowed to view your snapshot, e.g. from the document camera, before sending it as a snapshot by pressing **SNAPSHOT** again. The far end will not see the snapshot while you are adjusting it.

Duo Video Quality *

Auto: Optimized video depending on selected video source and bandwidth in use**.

Motion: Duo Video is optimized for smooth motion video. This mode is ideal if the image from two W.A.V.E. cameras should be simultaneously transmitted to the far end.

Sharpness: Duo Video is optimized for sharp video, Digital Clarity. This mode is ideal when using a document camera or a PC on Duo Video. If the far end does not support 4CIF live video, CIF will be selected.

Duo Video Mode *

Auto: Pressing any video source during a call will automatically open Duo Video (if the far end supports the automatic Duo Video functionality).

Manual: Duo Video must be opened by pressing **CONNECT** during a call and selecting '**Add Duo Video**'.

* - Requires option 'Presenter' and H263 video. To check which options are installed, see the 'System Info' menu in 'Diagnostics'.

** - 4CIF: PC and DocCam, otherwise CIF.

Duo Video Number*

Auto When adding Duo Video in a conference, Duo Video is connected automatically if supported by the far end.

Manual When adding Duo Video in a conference and connected towards a system with no Duo Video capabilities, enter the Duo Video Number into the 'Number' field in the 'Add Duo Video' menu. This can be the number to another system (only video will be transmitted to the system receiving Duo Video).

Duo Video / Snapshot Source

Select which video source Duo Video transmits.

If you want the document camera to be the default source when using Duo Video / snapshot, select '**Duo Video / Snapshot Source: DocCam**'.

To use the same video source as on the first connection for Duo Video / snapshot, select '**Duo Video / Snapshot Source: Current**'.

Auto-Display Snapshot

Select On to automatically display a received snapshot. If this selection is Off, you will have to press **SELFVIEW** to display a snapshot.

Snapshot Filter

Select On to remove any instability in the high quality snapshot.

Auto Request Floor

On When selecting 'Doc Cam' or 'PC' video sources, the system will automatically Request Floor when connected to a MCU conference.

Off When selecting 'Doc Cam' or 'PC' video sources, the system will not Request Floor.

* - Requires option 'Presenter'. To check which options are installed, see the 'System Info' menu in 'Diagnostics'.

Utilities

Utilities			
Autoanswer	<input checked="" type="radio"/> Off	<input type="radio"/> On	<input type="radio"/> On+MicOff
Far End Camera Control	<input type="radio"/> Off	<input checked="" type="radio"/> On	
Dual Monitor	<input checked="" type="radio"/> Off	<input type="radio"/> On	
Auto-PIP	<input type="radio"/> Off	<input checked="" type="radio"/> On	
Welcome Menu	<input type="radio"/> Off	<input checked="" type="radio"/> On	<input type="radio"/> Logo
Continuous Presence	<input type="radio"/> Off	<input checked="" type="radio"/> On	
MCU Status Line	<input type="radio"/> Off	<input checked="" type="radio"/> On	<input type="radio"/> Auto
System Name	<input type="text"/>		
Menu Password	<input type="text"/>		
Previous Menu			

Autoanswer

On: The system will automatically answer all incoming calls.

On+MicOff: The system will automatically answer all incoming calls and switch the microphone off when the call is connected. Press **MicOFF** to switch the microphone on.

Off: You must manually answer all incoming calls by pressing the **CONNECT** key.

Far end camera control

On: The far end will be able to:

- Control your camera
- Select your video sources
- Activate your presets
- Request snapshots

Off: None of the four features above on the local system can be accessed by the far end, however you will still be able to control the camera on the far end.

Dual Monitor

On: Selfview, snapshots and Duo Video will be displayed on the 2nd monitor.

Off: The 2nd monitor shows Selfview only.

Auto-PIP

On: Your selfview will automatically be displayed as a PIP (Picture-In-Picture) whenever the camera position or video source is changed. Picking up the remote control will also display your selfview.

Welcome Menu

The Welcome menu can be shown when the system is not in use, and when sleep-mode is not activated.

On: The Welcome Menu is shown when the system is not in sleep mode.

Off: The Welcome Menu is not shown.

Logo: If a logo is uploaded to the system, it will be shown when this button is selected.

Continuous Presence

On: The screen is divided into three or four squares, each displaying the video image of a different participant.

Off: The active site will be displayed in full screen during a MultiSite conference. Also called Voice Switched mode.

TIP TO DISPLAY YOUR SITE IN FULL SCREEN WHEN 'ON' IS SELECTED, PRESS THE QUICK KEY 'REQUEST FLOOR'.

MCU status line

On: The MultiSite/MCU/DuoVideo indicators will be displayed and provide information about the conference.

Off: The MultiSite/MCU/DuoVideo indicators will not be displayed.

Auto: The MultiSite/MCU/DuoVideo indicators will be displayed for a few seconds and then timed out. When grabbing the remote control, the indicators will be shown again.

System Name

Identifies the system:

- during an MCU conference call.
- when using the Web-interface.
- when the codec is acting as an SNMP Agent.
- towards a DHCP server.
- as an H323 ID. Other systems can call in using this name instead of IP-number/IP-address.

Menu Password

Enter the code which should be entered to get access to the menus on the TANDBERG system. When pressing the **Menu** button on the remote control, the user will be asked to enter the Password written here.

Web Snapshots

The system is able to generate JPEG snapshots and provide them to the world outside by request (as 'http get' or via ftp). See Appendix 5 for descriptions of the possible snapshot files.

On: Snapshots generation is enabled.

Off: Snapshots generation is disabled.

NOTE SNAPSHOTS ARE NOT GENERATED IF THE CONFERENCE IS SECURE.

MCU services

A Multipoint Control Unit (MCU) enables several sites to participate in the same conference.

An MCU conference can have different modes:

Voice Switched means that the image of the person currently speaking will be broadcast to all the other conference participants. This will remain the case until another participant starts to speak.

Continuous Presence shows several participants on the same screen at the same time.

Chairman Control functionality enables one participant to control the meeting by selecting which of the conference participants is to be broadcasted to the other participants.

THIS SYSTEM HAS AS AN OPTIONAL BUILT-IN MCU, MULTISITE, WHICH SUPPORTS UP TO 3 VIDEO CALLS (4 SITES) AND ONE TELEPHONE CALL. THE MULTISITE SUPPORTS BOTH VOICE SWITCHED AND CONTINUOUS PRESENCE MODE, SEE SECTION 'MULTISITE'.

The system can also control external MCUs in a very flexible manner using the functions described below.

DURING AN MCU CONFERENCE, A STATUS LINE WILL PROVIDE INFORMATION ABOUT THE CONFERENCE. TO REMOVE THIS STATUS LINE, SELECT 'UTILITIES', 'MCU STATUS LINE: OFF'.

MCU Services

Quick Menu

- Request Floor
- Release Floor
- Terminal Names
- View Site #
- End View
- Chair Control
- Previous Menu

Quick Menu

When connected to an MCU

TIP PRESS ANY QUICK KEY WHEN IN A MULTIPOINT CONFERENCE TO ACTIVATE THE QUICK MENU.



Request Floor

View Site #

Take Chair

This menu provides access to the most commonly used MCU functions.

If '**Request Floor**' is selected, 'Request Floor' will change to 'Release Floor'.

If '**View Site#**' is selected, 'View Site #' will change to 'End View'.

Selecting '**Take Chair**' will send a request to take chair. If granted, the Quick keys will be:



Floor To Site #

View Site #

Release Chair

If '**Floor to Site#**' is selected, 'Floor to Site#' will change to 'Rel. Floor To Site'.

If '**Release Chair**' is selected, you will return to the original Quick menu.

When MultiSite

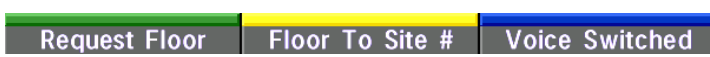

Request Floor

Floor To Site #

Voice Switched

If '**Voice Switched**' is selected, 'Voice Switched' will change to 'Cont. Presence'. This setting can also be changed in the 'Utilities' menu.

Request floor

When requesting the floor, the MCU will broadcast your video in full screen to all other participants in the conference. If the MCU conference has a chairman, a floor request is sent to the chairman.

You will remain 'On Air' until either you select '**Release Floor**' or the chairman decides to release the floor to another participant.

NOTE FLOOR WILL AUTOMATICALLY BE REQUESTED WHEN SENDING A SNAPSHOT OR SELECTING THE DOC CAM OR PC VIDEO SOURCES.

Release floor

You choose '**Release Floor**' to take you 'Off Air'. You should do this when you wish to make the floor available to the other participants in the conference.

Terminal Names

Allows you to see the site numbers or name (if supported) of other sites connected in the conference.

View site # *

Allows you to view any participant in the conference other than the participant currently 'On Air'.

End view

Allows you to stop viewing the site previously chosen with '**View Site #**', and returns your view to the site that is currently 'On Air'.

TIP '**VIEW SITE**' AND '**END VIEW**' CAN BE USED BY ALL CONFERENCE PARTICIPANTS.

* - NOT supported by the MultiSite

Chair Control

Take Chair
Release Chair
Floor To Site #
Rel. Floor To Site
Disconnect Site #
Terminate Meeting
Previous Menu

TIP IN ORDER TO MAKE USE OF CHAIR CONTROL FEATURES THE MCU MUST SUPPORT CHAIR CONTROL (H.243).

Chair control *

You select '**Chair Control**' and '**Take Chair**' to assume the role of chairman of the 'meeting'. As chairman, you may control which site you and the other sites see.

Take chair

Allows you to request chairmanship of the conference. If no one else is currently chairman the MCU will give you the chair.

Release chair

Allows you to release the privileges of chairmanship of the conference.

Floor to site #

Allows the chairman to select which of the conference participants is to be broadcast to all other participants.

Release Floor To Site

Allows the chairman to release the floor.

Disconnect site #

Allows the chairman to disconnect any participant in the conference.

Terminate meeting

Allows the chairman to terminate the conference altogether.

* - NOT supported by the MultiSite

Audio Settings

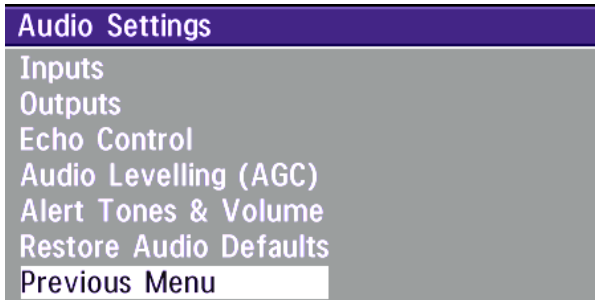

Audio Inputs

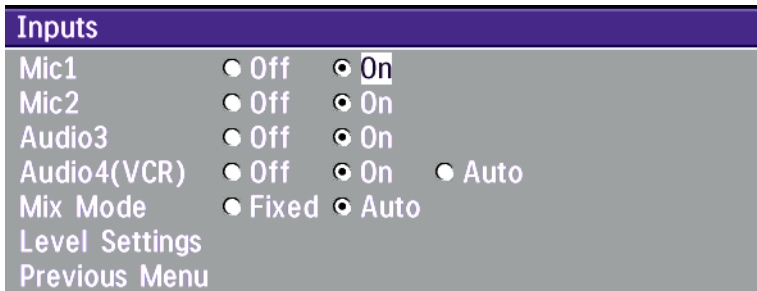

By default, all inputs are enabled. Just plug in an audio source and it is active. Audio inputs that are On will automatically be mixed. Select Off to prevent audio/noise from unused inputs or if you want to disable a specific input. The activated audio sources are stored on presets.

Mic 1 and 2 are intended for electret type microphones. The microphone inputs are balanced with 24V phantom power.

Audio input 3 is intended for connection to external playback devices or to telephone add-on hybrids.

As there is no acoustic echo canceller on this input it should not be connected to any microphones. The audio entering this input will be heard from the local speaker.

TIP EXTERNAL MIXER: WHEN USING AN EXTERNAL MIXER, IT IS VERY IMPORTANT THAT THIS IS A FIXED MIXER. AUTOMATIC, SMART AND OTHER TYPES OF ADAPTIVE MIXERS MIGHT CAUSE THE ECHO CANCELLER TO MALFUNCTION.

Audio input 4 is intended for connection to a VCR. It can also be connected to other external playback devices. As there is no acoustic echo canceller on this input it should not be connected to any microphones. The audio source connected to this input will be heard from the local speaker.

Mix Mode

'**Auto**' automatically adjusts the weighting of each microphone to obtain the best possible audio and minimizes the background noise. '**Auto**' will also attenuate the VCR audio level when someone talks into a microphone. '**Fixed**' will maintain a constant weighting for all microphones.

Level Settings

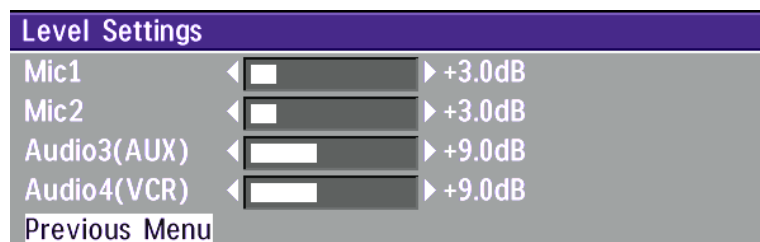

Adjust the audio input levels according to which external audio equipment is connected. The on-screen audio level indicator will make it easier to set the correct input level settings. The input level should be adjusted so that the average level reaches the preferred level marker.

The audio inputs are adjustable in steps of 1.5 dB from 0 dB to 22.5 dB.

The default levels for Mic 1 and 2 are set for use with an Audio Technica AT871 microphone in an average videoconferencing room. The gain can be adjusted correctly for a wide range of microphones.

A few examples of microphone levels are:

Audio Technica AT871	+3dB (default with system)
Audio Technica AT851R	+7dB
TANDBERG Audio Science	+19.5dB

Audio inputs 3 and 4 are set to a default level which is adhered to by most manufacturers of audio-visual equipment and is a level at which most audio-visual equipment (CD-players, VCRs) will work.

Audio Outputs

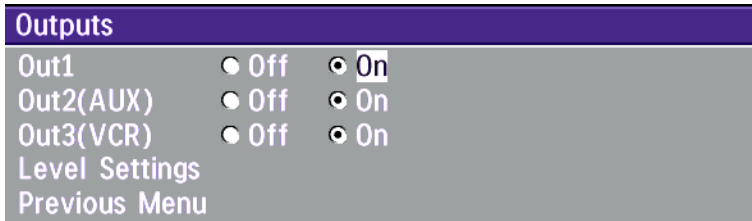

Audio out 1 is intended for connection to televisions or audio amplifiers.

Audio out 2 is intended for connection to audio recording equipment or to a telephone add-on hybrid. The signal is a mix of audio from both the far end and local end (not from Audio in 3).

Audio out 3 is intended for connection to a VCR or other recording equipment. The signal is a mix of audio from far end and local end (not from Audio in 4).

NOTE NEVER CONNECT AUDIO OUT 2 OR AUDIO OUT 3 TO A LOUDSPEAKER PLACED IN THE SAME ROOM AS THE MICROPHONES CONNECTED TO THE SYSTEM. DOING THIS WILL CAUSE "HOWLING" AND POSSIBLE DAMAGE TO THE SPEAKER SYSTEM.

If an output is '**Off**', no audio will be sent to that output.

Level Settings - Outputs

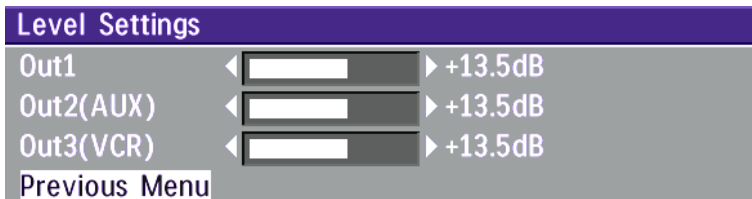

Adjust the audio output levels according to the parameters of the external audio equipment connected. These levels should only be adjusted when installing new audio equipment. The default settings are correct for the TANDBERG Natural Audio module and for most consumer electronics devices (televisions, VCRs, etc.).

The volume keys on the remote control adjust the level of output 1 (the speaker output). The volume control has no effect on outputs 2 and 3.

Echo Control

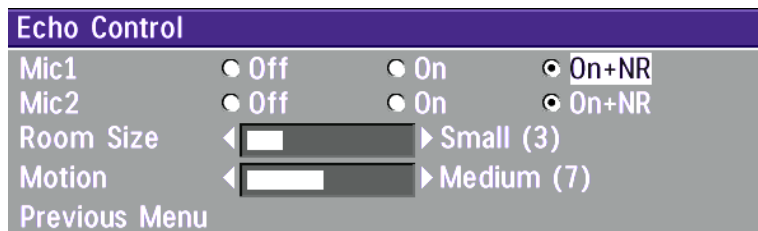

Each of the 2 microphone inputs have a separate echo canceller. One echo canceller per input provides more sophisticated control than having one common canceller for all microphones.

Echo control is normally set to '**On**' to prevent the far end from hearing their own audio. Once selected, echo cancellation is active at all times. The echo canceller continuously adjusts itself to the audio characteristics of the room and compensates for any changes it detects in the audio environment. If the changes in the audio conditions are very significant the echo canceller may take a second or two to re-adjust.

You can choose to switch off the echo canceller for the available audio sources.

NOTE **ECHO CONTROL** SHOULD BE SWITCHED '**OFF**' IF EXTERNAL ECHO CANCELLATION OR PLAYBACK EQUIPMENT IS USED. IT IS YOUR ECHO CANCELLER THAT IMPROVES THE AUDIO QUALITY EXPERIENCED BY THE OTHER SITE. WHEN YOU HEAR AN ECHO OF YOUR OWN AUDIO IT IS MOST LIKELY THE FAR END'S ECHO CANCELLER THAT IS MALFUNCTIONING.

Noise Reduction

In addition to echo cancellation, the system has built-in noise reduction (NR).

NR reduces constant background noise (e.g. noise from air-conditioning systems, cooling fans etc.). In addition, a highpass filter (Humfilter) reduces very low frequency noise.

Choose **On+NR** to activate both Echo Control and Noise Reduction.

Room Size

This setting allows optimization of the echo canceller to the acoustic size of the room. Hard walls, many windows etc. might require higher settings than expected. Carpets, curtains etc. might require lower settings. Adjust the setting (NOTE: on the far end) if one of the following symptoms occur:

- There is still some echo of your own audio. Increase the setting.
- The system adapts slowly to acoustic changes in the room. Decrease the setting.

After a change, the system will need a few seconds to re-adjust.

Motion

If you experience echo caused by movements in the room, increase the value.

Automatic Gain Control (AGC) Settings

Audio Levelling (AGC)	
Mic1-2	<input type="radio"/> Off <input checked="" type="radio"/> On
Audio3(AUX)	<input type="radio"/> Off <input checked="" type="radio"/> On
Audio4(VCR)	<input type="radio"/> Off <input checked="" type="radio"/> On
Received Audio	<input checked="" type="radio"/> Off <input type="radio"/> On
Previous Menu	

Select '**On**' to allow automatic adjustments (Automatic Gain Control) of audio levels. When '**On**', the AGC maintains the audio signal level at a fixed value by attenuating strong signals and amplifying weak signals. Very weak signals, i.e. noise alone, will not be amplified.

Example: In most conferences, the participants will speak at different levels, and be at different distances from the microphones. As a result, some of the participants would be harder to hear than others. The AGC corrects this problem by automatically increasing the microphone levels when “quiet” or “distant” people speak, and by decreasing the microphone levels when “louder” people speak.

NOTE TO ENSURE CORRECT BEHAVIOUR OF THE AGC, IT IS CRUCIAL THAT THE LEVELS ON THE INPUT CONNECTORS ARE ADJUSTED CORRECTLY USING THE AUDIO INPUT LEVEL SETTINGS. THE AGC WILL NOT COMPENSATE FOR SEVERE MISADJUSTMENT OF INPUT LEVELS.

When applying a weak signal in the presence of strong background noise, the AGC might amplify the background noise as well as the signal. Therefore, in noisy environments, it is advisable to turn the AGC off.

Tips for improving the echo canceller performance:

- Place all microphones as far as possible from the loudspeaker. Minimum loudspeaker-microphone distance should be 1 meter.
- Place all microphones as close as possible to the persons speaking. By using several microphones, the ratio distance loudspeaker-to-mic/mic-to-speaker can be increased. Increasing this ratio improves the echo canceller performance. Avoid distances above two meters from any participant to his/her closest microphone. If necessary, use several microphones. Also avoid placing microphones less than one meter from any person.
- Place all microphones as far as possible from noise sources.
- Reduce the volume setting. Ensure that the loudspeaker does not distort the audio.

- The echo canceller tries to estimate the echo path from the speaker system to the microphones. Moving objects change this path, therefore try to avoid moving objects. Be especially aware of large objects and objects placed close to either the microphone or the speaker system as these objects will cause severe changes to the echo path.
- Avoid putting paper sheets etc. on the microphone.
- Avoid moving the microphone or loudspeaker.
- In the event of poor echo cancelling, allow the canceller to adapt. After each change, the echo canceller requires a few seconds to adapt. Do not change the settings without allowing the echo canceller to adapt to the new audio environment.
- In the presence of low frequency noise, enable the noise reduction (NR).

Alert Tones & Volume

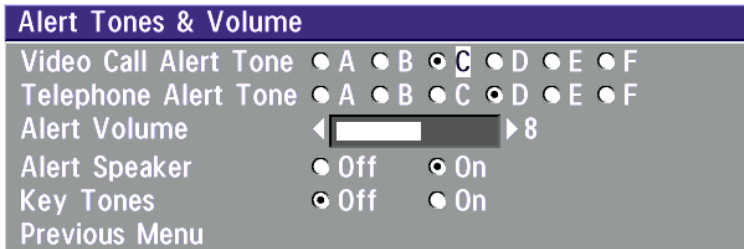

To help distinguish between incoming video calls and ordinary telephone calls, different ringing tones may be selected. You may also select different volume levels for the ringing tone.

Alert Speaker

The system also has an internal, call alerting speaker.

On: The internal speaker will warn you of an incoming call even though the monitor may not be switched on.

Key Tones

The Key Tones may be switched on and off.

Restore Audio Defaults

There are many audio settings and the codec could easily be made unusable by configuring these by mistake. It is therefore possible to return all audio settings to their factory default settings by using Restore Audio Defaults.

Video Settings

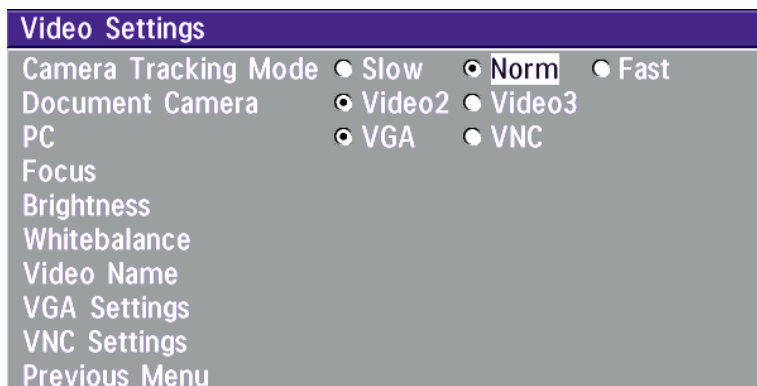

NOTE THE CAMERA TRACKING MODE ENTRY WILL NOT BE AVAILABLE IF NOT USING THE WAVE CAMERA.

Camera Tracking Mode

Select the camera tracking mode:

- Slow:** The system waits a while before zooming in on a single person speaking. Suitable when wide-angle images are preferred over close-up images.
- Norm:** Should be used in regular meetings.
- Fast:** The system quickly zooms in on a single person speaking. Suitable when close-ups are preferred over wide-angle images.

Document Camera

Users of a document camera with an S-video output can configure the system to activate an S-video input when pressing 'doc cam' on the remote control.

Video2: Video Input 2 (S-video) will be activated when pressing 'doc cam' on the remote control.

Video3: Video Input 3 (Composite) will be activated when pressing 'doc cam' on the remote control.

PC*

Configure what should be activated when pressing **PC**.

VGA: Pressing **PC** will activate the VGA input on the system (default).

VNC: Pressing **PC** will use VNC to show images from your PC (see 'VNC Settings' for further information).

* - Requires option 'Presenter'. To check which options are installed, see the 'System Info' menu in 'Diagnostics'.

Focus

To manually adjust the focus select '**Manual**' and use the arrow keys to adjust.

Brightness

To manually adjust the brightness select '**Manual**' and use the arrow keys to adjust.

Whitebalance

In Auto mode the whitebalance is continuously updated. To update the whitebalance manually, select '**Manual**' and press **OK**.

TIP A WHITE OBJECT SHOULD BE HELD IN FRONT OF THE CAMERA A FEW SECONDS BEFORE AND AFTER SELECTING MANUAL WHITEBALANCE.

Video Name

Video Name	
Video1	main
Video2	doc
Video3	aux
Video4	vcr
VGA	pc
Previous Menu	

As a default each video input corresponds to the name used on the remote control.

To edit the name, use the number keys on the remote control.

VGA Settings

VGA Settings

NOTE: Only change to Main or Dual if a VGA monitor is connected.

VGA Out Main Dual Loop

VGA Out Quality Auto

VGA 640x480, 60Hz

SVGA 800x600, 60Hz

XGA 1024x768, 60Hz

Previous Menu

NOTE IF YOU SET 'VGA OUT' TO 'MAIN', MAKE SURE YOU HAVE A VGA-MONITOR CONNECTED TO THE VGA-OUTPUT ON THE SYSTEM. IF YOU DO NOT HAVE A VGA-MONITOR CONNECTED, YOU WILL NOT BE ABLE TO SEE THE MENU SYSTEM!

NOTE iCIF WILL NOT BE AVAILABLE WHEN VGA OUT IS MAIN OR DUAL.

VGA Out

To enhance the local video quality, a VGA monitor may be connected.

- Main:** Should be used if you want to use a VGA monitor as your main monitor. Video outputs 1 and 3 will be disabled.
- Dual:** Should be used if you want to use a VGA monitor as your dual monitor. Video outputs 2 and 4 will be disabled.
- Loop:** Should be used if you want to use a TV monitor as your main monitor.

VGA Out Quality

VGA Out Quality changes the resolution of the VGA signal available on the '**VGA Out**' connector at the rear of the codec.

- Auto:** Will sense the resolution on the '**VGA input**' port and use the same resolution on the '**VGA Out**' port.
- VGA:** Will force '**VGA out**' to VGA(640X480).
- SVGA:** Will force '**VGA out**' to SVGA(800X600).
- XGA*:** Will force '**VGA out**' to XGA(1024X768).

* - E2 Only

VNC Settings*

The screenshot shows a graphical user interface for VNC settings. It features a purple title bar at the top with the text 'VNC Settings'. Below this, there are several input fields: 'Address' containing '127.0.0.1', 'Display Number' containing '0', and 'Password' containing seven asterisks. A 'Previous Menu' button is located below the password field. At the bottom of the screen, there is a 'Back' button. The status bar at the very bottom indicates 'VNC: Idle'.

NOTE VNC SERVER SOFTWARE SETUP

- BOTH THE PC AND THE VIDEOCONFERENCING SYSTEM MUST BE CONNECTED TO THE SAME LAN.
- A VNC SERVER MUST BE INSTALLED ON THE PC. FREE SOFTWARE CAN BE DOWNLOADED FROM [HTTP://WWW.UK.RESEARCH.ATT.COM/VNC](http://www.uk.research.att.com/vnc)
- INSTALL THE SOFTWARE BY RUNNING THE DOWNLOADED FILE.
- TO CONFIGURE THE VNC SERVER SOFTWARE :
 - SELECT "ACCEPT SOCKET CONNECTIONS".
 - SELECT "AUTO" FOR "DISPLAY NUMBER". 'DISPLAY NUMBER' IN THE SYSTEM MUST THEN HAVE THE VALUE 0.
 - ENTER A PASSWORD IN THE "PASSWORD"-FIELD. MUST CORRESPOND WITH THE 'VNC SETTINGS' ON YOUR SYSTEM.

Address

The IP-address of the PC with the VNC software installed. To find the IP-address of the PC, select 'Command Prompt' from the Startup-menu. Type 'ipconfig' and press ENTER.

Display Number

The display number for VNC is 0 and upwards. If you are using WinVNC, double-click on the icon on the toolbar to view 'WinVNC properties'. This number should correspond with 'Display Number' in this menu.

Password

Enter the same password as specified in WinVNC properties. The password will be shown as asterisk signs (*) the next time you enter the menu.

Start using VNC

To activate VNC, press 'PC' on the remote control. Please make sure that 'PC' is set to 'VNC' in the 'Video Settings Menu'. See also 'PC SoftPresenter' section for further information.

* - Requires option 'Presenter'. To check which options are installed, see the 'System Info' menu in 'Diagnostics'.

Terminal Settings

This menu provides basic network setup for the unit and should be used when installing the system.

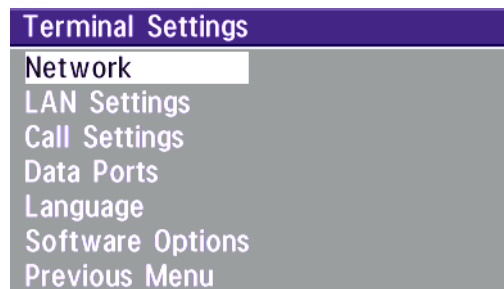

Network Configuration

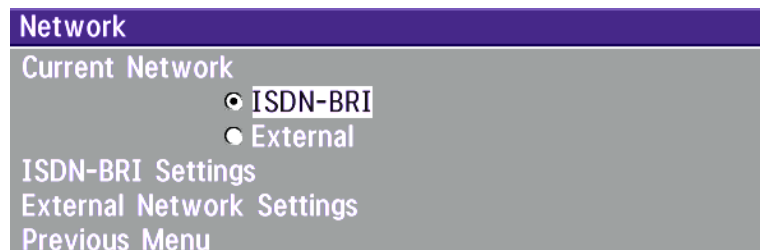

Before using the system it is necessary to specify which network to use and define its settings.

If you want to use your system via ISDN-BRI you should select '**Current Network: ISDN-BRI**' and enter the '**ISDN-BRI Settings**' menu to set the BRI parameters.

If you want to use special networks and connect using RS449, V.35, X.21 or connect to ISDN via an external IMUX you should select '**Current Network: External**' and enter the '**External Network Settings**' menu to set the External Network parameters.

ISDN-BRI Settings

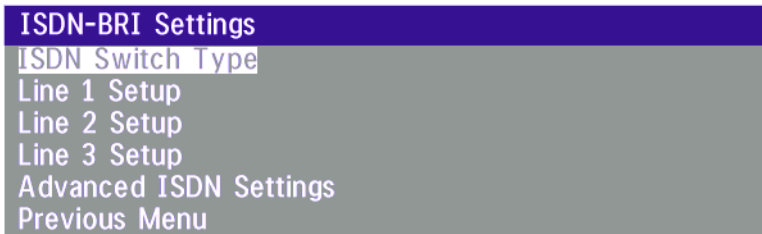

NOTE SOME SOFTWARE VERSIONS DO NOT SUPPORT 3 ISDN LINES, THEREFORE SOME OF THE LINE SETUP ENTRIES MAY BE GRAYED OUT.

NOTE IF NATIONAL ISDN IS SELECTED, PRESS THE QUICK KEY '**Auto BRI CONFIG**' TO REQUEST AN AUTOMATIC CONFIGURATION OF THE LINE & SPID SETTINGS (SWITCH MUST SUPPORT GR-2941-CORE).

NOTE MANDATORY ISDN-BRI SETTINGS
 TO MAKE SURE YOUR SYSTEM WILL WORK PROPERLY USING ISDN-BRI, MAKE THE FOLLOWING SETTINGS:

- SET ISDN SWITCH TYPE
- ENTER ISDN LINE NUMBERS (+ SPIDs IF REQUIRED)
- DISABLE UNUSED LINES

ISDN switch type

Select the type of ISDN network connected to your unit.



NOTE 1TR6 SHOULD ONLY BE USED IF YOU ARE OPERATING THE SYSTEM BEHIND A PABX.

Line setup

This menu allows you to program the numbers associated with your ISDN line.

Line 1 Setup

Enabled Off On

Number1 67838498

Number2 67838498

SPID1

SPID2

Previous Menu

If you want to use this ISDN line, you need to set '**Enabled: On**' and enter the numbers of your ISDN line. If some of the ISDN lines are not to be used, set '**Enabled: Off**'. Line 1 should always be enabled.

National ISDN and AT&T Custom ISDN might require SPID numbers associated with your ISDN numbers. If you have received two different SPID numbers for each ISDN line from your telephone company, you must program both.

Example:

	Numbers	SPIDS
ISDN BRI 1:	67838498	016783849800
	67838498	016783849810
ISDN BRI 2:	23478060	012347806000
	23478070	012347807000
ISDN BRI 3:	23478420	012347842000

Line 1 Setup

Enabled Off On

Number1 67838498

Number2 67838498

SPID1 016783849800

SPID2 016783849810

Previous Menu

Advanced ISDN settings

Advanced ISDN Settings	
Subaddress	<input type="text" value=""/>
Validate Numbers (MSN)	<input type="radio"/> Off <input checked="" type="radio"/> On
Parallel Dial	<input checked="" type="radio"/> Off <input type="radio"/> On
Send Own Numbers	<input type="radio"/> Off <input checked="" type="radio"/> On
Sending Complete	<input type="radio"/> Off <input checked="" type="radio"/> On
Previous Menu	

Subaddress

Using a subaddress enables you to connect up to eight ISDN terminals to the same ISDN telephone number and line. The terminals are addressed by using different subaddresses.

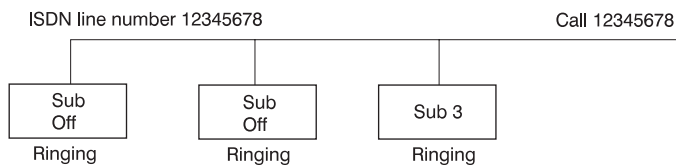

To call a terminal with a subaddress, separate the ISDN telephone number and the subaddress with a '*'.

Example: 12345678*2 (Up to four digit subaddresses are possible)

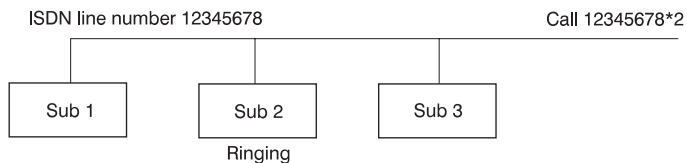

THIS SERVICE HAS LIMITED ACCESS ON SOME ISDN NETWORKS.

MSN (Multiple Subscriber Number)

The use of MSN (Multiple Subscriber Number) enables you to attach different ISDN terminals, with different numbers, to the same physical ISDN telephone line. If **'Validate Numbers'** is set to **'On'** only calls to those numbers specified in the Line Setup menus will be answered. This service can be ordered from your telephone company.

Parallel dial

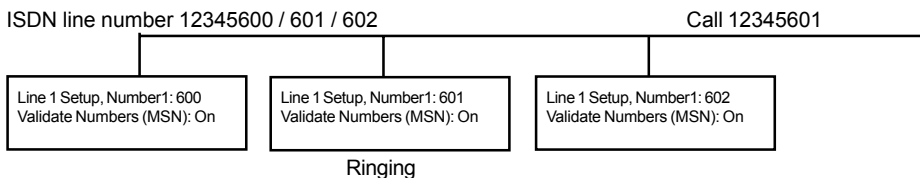

On Channels will be dialed and connected in parallel when setting up a BONDING call.

Off Channels will be dialed one by one which may increase the dialing time.

Send Own Numbers

On The system will send its own numbers to the far end.

Off The system will not send its own numbers to the far end, but please note that the network may still send your numbers to the far end.

Sending Complete

On The system will send the ISDN message information element 'Sending Complete'.

Off The system will not send 'Sending Complete'.

External network settings

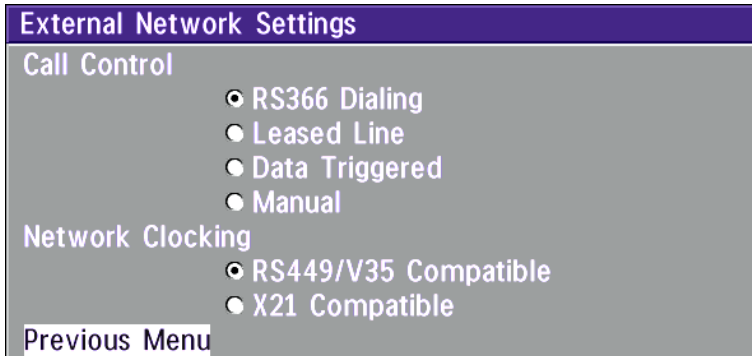

NOTE IMPORTANT: THE PHYSICAL INTERFACE ON EXTERNAL NETWORKS IS ONE NON-STANDARD 26 PIN CONNECTOR. SPECIAL CABLES ARE REQUIRED.

Before using the system together with external network equipment, you must specify the network parameters on this page.

NOTE THE SYSTEM HAS SUPPORT FOR UP TO 384KBPS USING THE EXTERNAL NETWORK (RS449/V.35/X.21) INTERFACE.

Call Control

'**RS366 Dialing**' is the only dialing protocol and would normally be used together with network clocking '**RS449/V35 Compatible**' when the external equipment uses RS366 ports.

'**Leased Line**' is a non-dialing protocol and should be used when two codecs are connected in a point to point connection. Use '**Leased Line**' when the handshaking signals DTR and CD are available. DTR and CD correspond to the X21 network's C and I signals.

'**Data Triggered**' mode uses TxData (transmit data), RxData (receive data) and clock signals only. Use '**Data Triggered**' when no handshake signals are available.

'**Manual**' should be used when no handshake signals are available, and the external equipment requires a constantly connected line.

TIP TO MAKE AN IP CALL WHEN 'LEASED LINE' IS SELECTED, ENTER A NUMBER BEFORE PRESSING CONNECT TO ACTIVATE THE DIAL MENU.

Network clocking

The network clock setting specifies the number of physical external clock signals.

Use '**RS449/V35 Compatible**' when the external equipment provides two clock signals, one for transmit and one for receive. The difference between RS449 and V35 is the cable only.

Use '**X21 Compatible**' when the external equipment provides a common clock signal for both transmit and receive.

Cable Specification, V.35

V.35/RS-366 cable				
Signal Name	Female 26pin DSUB Pin number	Male 34pin Winchester Pin number	Male 25pin DSUB	Comments
Frame ground	1	A		
Signal ground	19,23	B		
TX(A), transmit data	11	P		Twisted pair
TX(B)	12	S		
RX(A), receive data	13	R		Twisted pair
RX(B)	14	T		
RCLK(A), rev clock	15	V		Twisted pair
RCLK(B)	16	X		
TCLK(A), xmt clock	17	Y		Twisted pair
TCLK(B)	18	AA		
DTR	26	H, C		
RI	24	L, J		
RLSD	22	F		
RS366 DPR	2		2	
RS366 ACR	3		3	
RS366 CRQ	4		4	
RS366 PND	5		5	
RS366 DLO	6		22	
RS366 NB1	7		14	
RS366 NB2	8		15	
RS366 NB4	9		16	
RS366 NB8	10		17	
RS366 GND	19		7	
Cable Marking	NET	DSU V.35	DSU RS366	

LAN Settings

LAN Settings
Streaming Settings
H.323 Settings
IP Settings
SNMP Settings
Previous Menu

Streaming*

Streaming Settings	
Address	224 . 2 . 34 . 22
Address Port	22232
TTL/Router Hops	1 (1..255)
Streaming Source	<input checked="" type="radio"/> Auto <input type="radio"/> Local <input type="radio"/> Remote
Allow Remote Start	<input type="radio"/> Off <input checked="" type="radio"/> On
Announcements	<input type="radio"/> Off <input checked="" type="radio"/> On
Video rate (kbps)	◀ [] ▶ 64
Password	[]
Previous Menu	

NOTE WHEN STREAMING, A MULTISITE OR A DUO VIDEO CALL CAN NOT BE MADE.

NOTE AN ON-SCREEN INDICATOR IS SHOWN WHEN STREAMING IS ACTIVE.

Start Streaming		Back
-----------------	--	------

Address

Address is defined as the IP-address of a streaming client, streaming server or a multicast address. Giving an address in the range 224.0.0.1-239.255.255.255 will broadcast the stream to any host that has joined the specified multicast group. Specifying normal broadcast address 255.255.255.255 will broadcast to any members on the LAN.

Address Port

If several codecs are streaming to the same IP-address, different ports have to be used in order for the client to know which stream to receive. If the first codec streams on port 2240 and the second codec on port 2250, the client has to specify which port to listen to. Video is transmitted on the specified port, audio is transmitted on the port number 4 above the specified video port, in this case 2244 and 2254.

TTL/Router Hops

This is used for streaming data to limit how many routers the data should pass before it is rejected. If TTL is set to 2, data will not traverse more than 2 router hops.

* - Please contact your TANDBERG representative for further information.

Streaming Source

Auto Enables streaming of both local and far end video. Selection of which site to be streamed is done using voice switching (the site that speaks is streamed).

Local Only the local video will be streamed.

Remote Only the far end video will be streamed.

Local and far end audio is always streamed.

Allow Remote Start

On Streaming can be started from external user interfaces like the Web-browser or Telnet session.

Off Streaming can only be started from the Video Conferencing System using the remote control, or by using the Dataport. This will prevent activation of streaming using Web browser or Telnet sessions.

Announcements

On The codec will announce to the network that it is streaming. This enables a streaming client (e.g. a PC) to connect to the codec's streaming session. Used by Cisco IP/TV.

Off No announcement packets will be transmitted.

Video Rate

Defines the Video streaming rate from the system. Range is 16kbps - 320kbps. In addition, audio (G.711) streaming rate is 64kbps, providing a maximum streaming rate of 384kbps.

Password

Set password so that only participants entering correct password will be able to view the streaming session. Entering a password will prevent unauthorized people from accessing the streaming session.

Start/Stop Streaming

By pressing the Quick Key labeled ' Start Streaming ', the Streaming session will start. To stop the stream, press the same quick-key, which will be labeled ' Stop Streaming ' while the streaming-session is active. Pressing Disconnect will also stop the streaming session.

How to view streaming

After streaming is started, an easy way to view the streamed audio/video is to start your Web-browser and enter the IP-address of the streaming system. After the Web page of the codec is shown, click on 'Streaming'. Alternatively, enter `http://<codec ip-address>/stream.sdp`.

H.323 Settings

H.323 Settings	
E.164 Alias	<input type="text"/>
Use Gatekeeper	<input type="radio"/> Auto <input checked="" type="radio"/> Manual <input type="radio"/> Off
Gatekeeper IP	<input type="text" value="10"/> . <input type="text" value="0"/> . <input type="text" value="0"/> . <input type="text" value="1"/>
Use CallManager	<input type="radio"/> On <input checked="" type="radio"/> Off
CallManager IP	<input type="text" value="127"/> . <input type="text" value="0"/> . <input type="text" value="0"/> . <input type="text" value="1"/>
H.323 Prefix	<input type="text"/>
Advanced H.323 Settings	
Previous Menu	

Register	Back
----------	------

E.164 alias

This is the E.164 address of the codec. The E.164 address is equivalent to a telephone number, sometimes combined with access codes. Valid characters are 0-9,* and #.

When using a gatekeeper the codec will send a message to the gatekeeper containing both the E.164 address and the system name of the codec. The codec will not register with the gatekeeper if the E.164 alias is not set.

Use Gatekeeper

Auto The codec will automatically try to register on any available gatekeeper. If a gatekeeper responds to the request sent from the codec within 30 seconds this specific gatekeeper will be used. If no gatekeeper responds, the codec will not use a gatekeeper for making H.323 calls and hence an IP-address must be specified manually.

Manual The codec will use a specific gatekeeper identified by '**Gatekeeper IP-address**'.

Off The codec will not use a gatekeeper and an IP-address must be used in order to make an H.323 call.

Gatekeeper IP-address

This is the gatekeeper IP-address if you specify '**Use Gatekeeper: Manual**'.

Use CallManager

- On** The codec will use a specific Cisco CallManager identified by the IP-address specified in '**CallManager IP**'. The CallManager replaces a gatekeeper, therefore '**Use Gatekeeper**' must be set to '**Off**' before this can be done. When '**On**', '**Use Gatekeeper**' and '**Gatekeeper IP**' is disabled.
- Off** The codec will not use Cisco CallManager.

CallManager IP

The CallManager IP-address specified here will be used if '**Use CallManager: On**'.

H.323 Prefix

When dialing a number prefixed with digits specified by '**H.323 Prefix**', and with '**Net: Auto**', an H.323 call will be placed. *Example:* H.323 Prefix is '555'. Dialling '55582' with 'Net:Auto' will select LAN.

Register

Pressing '**Register**' will send a gatekeeper registration request. This request will also be sent when leaving the menu.

Advanced H.323 Settings

Advanced H.323 Settings	
RSVP	<input checked="" type="radio"/> Off <input type="radio"/> Auto
NAT	<input checked="" type="radio"/> Off <input type="radio"/> On
NAT Address	127 . 0 . 0 . 1
H.323 Ports	<input checked="" type="radio"/> Static <input type="radio"/> Dynamic
QoS Type	<input type="radio"/> Off <input type="radio"/> Diffserv <input checked="" type="radio"/> IP Precedence
IP Precedence	
Diffserv	
Previous Menu	

NOTE THESE SETTINGS ONLY HAVE AN EFFECT IF THEY ARE SUPPORTED BY YOUR IP INFRA STRUCTURE.

RSVP

Auto Resource Reservation Protocol enables the endpoints to request the optimal amount of bandwidth for the duration of an IP video conference.

Off Resource Reservation Protocol is switched off.

NAT

NAT, Network Address Translation, is used in small LAN's, often home offices, when a PC and a videoconferencing system is connected to a router with NAT support. NAT support in the videoconferencing system enables proper exchange of audio/video data when connected to an external videoconferencing system (when the IP traffic goes through an NAT router).

When NAT is On, the NAT Server Address will be shown in the startup-menu: 'My IP Address: 10.0.2.1 (NAT)'

NAT Address

This must be the external/global IP-address to the router with NAT support. Packets sent to the router will then be routed to the codec.

In the router, the following ports must be routed to the codec's IP-address:

Port 1720

Port 5555-5560

Port 2326-2365

Please contact your TANDBERG representative for further information.

H.323 Ports

Static When selecting static H323 ports for TCP connections the ports 5555 or 5556 will be used for Q931 and H245 respectively.

Dynamic The operating system will allocate which ports to use when opening a TCP connection.. The reason for doing this is to avoid using the same ports for subsequent calls as some firewalls consider this as a sign of attack.

QoS Type

Off No QoS is used

Diffserv Diffserv QoS method is used. Please see below for details.

IP Precedence IP Precedence QoS method is used. Please see below for details.

IP Precedence

Used to define which priority audio, video, data and signalling should have in the network. Higher numbers indicate higher priority. The priority ranges from 0(off) - 7 for each type of packets .

IP Precedence

Audio Auto

Video Auto

Data Auto

Signaling Auto

IP Type of Service (TOS)

Delay Throughput Off

Reliability Cost

Previous Menu

Auto will provide the following priority:

Audio	4
Video	4
Data	3
Signalling	6

IP Type of Service (TOS)

Helps a router select a routing path when multiple paths are available.

Delay Tells the router to minimize the delay

Throughput Tells the router to maximize the throughput

Reliability Tells the router to maximize the reliability

Cost Tells the router to minimize the cost

Diffserv

Used to define which priority Audio, Video, Data and Signaling packets should have in an IP network. The priority ranges from 0 to 63 for each type of packets.

Diffserv

Audio 0 (0..63)

Video 0 (0..63)

Data 0 (0..63)

Signaling 0 (0..63)

Previous Menu

IP Settings

IP Settings	
IP-assignment	<input type="radio"/> DHCP <input checked="" type="radio"/> Static
IP-address	10 . 0 . 5 . 151
IP-subnet mask	255 . 255 . 0 . 0
Gateway	10 . 0 . 0 . 1
Ethernet Speed	<input type="radio"/> 10/Half <input type="radio"/> 10/Full <input type="radio"/> 100/Half <input type="radio"/> 100/Full <input checked="" type="radio"/> Auto
Previous Menu	

NOTE CHANGES IN THIS MENU WILL NOT HAVE ANY EFFECT BEFORE THE SYSTEM IS RESTARTED.

IP-assignment

DHCP (Dynamic Host Configuration Protocol) can be selected when a DHCP server is present.

DHCP: IP-address, IP-subnet mask and Gateway are not used because these parameters are assigned by the DHCP server.

Static: The codec's IP-address and IP-subnet mask must be specified in the IP-address field.

IP-address

IP-address defines the network address of the codec. This address is only used in static mode. In DHCP-mode, the assigned IP-address can be found on the Welcome Menu.

IP-subnet mask

IP-subnet mask defines the type of network. This address is only used in static mode. Your LAN-administrator will provide the correct value for this field.

Gateway

When using DHCP, the default gateway will be set automatically. If the LAN utilizes static IP addresses, IP address, subnet mask, and default gateway must be specified by the LAN administrator.

Ethernet Speed

Auto	The codec will auto-detect the speed/duplex on the LAN.
10/Half	The codec will connect to the LAN using 10Mbps speed/Half Duplex.
10/Full	10 Mbps speed/Full Duplex.
100/Half	100 Mbps speed/Half Duplex.
100/Full	100 Mbps speed/Full Duplex.

Restart

Pressing the Quick key 'Restart' will restart your system without having to use the On/Off switch on the codec. If IP-assignment is changed, it is sufficient to use this Quick key to restart the system.

SNMP Settings

SNMP Settings				
SNMP Trap Host	10	.0	.5	.100
SNMP Trap Host	127	.0	.0	.1
SNMP Trap Host	127	.0	.0	.1
SNMP Community				
Previous Menu				

SNMP Trap Host

SNMP (Simple Network Management Protocol) is used for monitoring and configuring of different units in a network. The codec's **SNMP Agent** responds to requests from **SNMP Managers** (a PC program etc.). **SNMP traps** are generated by the agent to inform the manager about important events.

SNMP Trap Host identifies the IP-address of the SNMP manager.

Traps can be sent to multiple SNMP Trap Hosts. Enter the IP address of up to three SNMP managers. All traps will then be sent to the hosts listed.

SNMP Community

SNMP Community names are used to authenticate SNMP requests. SNMP requests must have a 'password' in order to receive a response from the SNMP agent in the codec.

NOTE THE SNMP COMMUNITY NAME IS CASE SENSITIVE.

Call Settings

Call Settings		
Incoming MCU Calls	<input type="radio"/> Off	<input checked="" type="radio"/> On
Incoming Telephone Calls	<input type="radio"/> Off	<input checked="" type="radio"/> On
Fallback to Telephony	<input type="radio"/> Off	<input checked="" type="radio"/> On
Access Code	<input checked="" type="radio"/> Off	<input type="radio"/> On
Encryption	<input type="radio"/> Off	<input checked="" type="radio"/> Auto
Encryption Mode	<input checked="" type="radio"/> Auto	<input type="radio"/> AES <input type="radio"/> DES
Max Call Length (min, 0=Off)	0	
Network Profiles		
Previous Menu		

Incoming MCU calls

- On:** When you are in a call, the system will provide visual and audible indications of an incoming call and ask you to accept/reject the call.
- Off:** The system will not accept incoming calls when you are in a call.

Incoming telephone calls

- On:** The system will accept incoming telephone calls.
- Off:** The system will not accept incoming telephone calls. This is useful to prevent incoming calls from systems other than videoconferencing systems.

Fallback to telephony

- On** Enables fallback from video calls to telephony/speech calls.
- Off** Disables fallback.

Access Code

- On** When pressing CONNECT or any number to make a call, an Access Code menu will be shown. The user will then have to enter the correct Access Code in order to make a call.
- Off** No Access Code is necessary to make a call.

Access Code	
█	
Enter access code and press OK	
OK	Cancel

Encryption (Secure Conference)*

Auto The system will try to set up calls using encryption.

Point to point calls: If the far end system supports encryption, the call will be encrypted. If not, the call will proceed without encryption.

ISDN MultiSite calls: In order to have encrypted MultiSite calls on ISDN, all sites must support encryption. The padlock symbol will indicate encryption mode (AES* or DES). If there is a mix of AES* and DES encryption, only the symbol for DES encryption (single padlock) will be displayed.

IP MultiSite calls: Sites supporting encryption will be encrypted and sites not supporting encryption will not be encrypted. The padlock symbol will be shown on the MultiSite if all sites support encryption. The padlock symbol will be shown on the site connected to the MultiSite if this connection to the MultiSite is encrypted.

If the far end supports encryption, the systems will initiate encryption after the call is connected (an 'open padlock' symbol will be displayed). When encryption has been established, a 'closed padlock' symbol will be displayed.

Off The system will not send or receive encrypted data.

Technical encryption information like encryption algorithm and encryption check code can be found in the 'Call Status' menu.

Encryption Mode

Auto The system will try to use the most secure encryption - AES*, dependent on the capabilities of the other sites. If AES* encryption is not supported by all the other sites, DES encryption will be tried.

AES* The system will try to use AES* with 128 bits encryption when setting up ISDN calls. If AES* is not supported by all other sites, no other type of encryption will be initiated.

DES The system will always try to set up the call using DES with 56 bits encryption on ISDN and IP. If DES is not supported by all other sites, no other type of encryption will be initiated.

TIP

BOTH AES* AND DES ENCRYPTION IS SUPPORTED FOR MIXED ISDN/IP CALLS. IN ADDITION AES* -AND DES ENCRYPTED SITES CAN BE CONNECTED AT THE SAME TIME.

TIP

THE MULTISITE CAN RUN 4 ENCRYPTED SITES AT 128 KBPS AND 3 ENCRYPTED SITES AT 256KBPS.

* Optional feature

Max Call Length

This feature will automatically end both incoming and outgoing calls when the call time exceeds the specified 'Max Call Length'.

Max Call Length can have the following values: 0-999(minutes), where 0 is Off.

A few minutes before the specified time is reached, a Quick-Key menu will appear. Users will be asked if he/she wants to extend the specified 'Max Call Length':



Network Profiles

This menu defines the settings listed when pressing the Quick key '**Net:**' while in the dial menu.

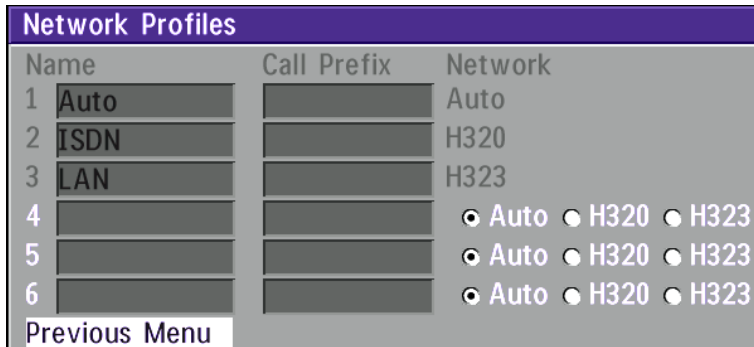

This menu consists of 6 network profiles, a prefix can be added for each profile. If you add a prefix to a profile, this prefix will automatically be added to the number being dialed.

EXAMPLE: 0 IS ADDED AS A CALL PREFIX TO THE 2ND PROFILE, ISDN. IF YOU ENTER 12345678 IN THE DIAL MENU AND SELECT 'ISDN', THE NUMBER DIALED WILL BE 012345678.

Using the three last profiles you can enter the name of a profile, prefix and network selection. This is useful if you have a fixed prefix for your service provider.

Dataport configuration

The system provides two standard RS232 serial ports to allow a computer to be connected for data transfer and control purposes.

NOTE WHEN CONNECTING TO A PC THE CONNECTING CABLE *MUST* BE A STRAIGHT THROUGH RS232 CABLE.

Dataport 1

If you wish to connect a PC to Dataport 1, you must ensure that the PC and the system are identically configured. The available settings are:

Dataport 1 supports 4 different modes:

Data Port 1			
Baudrate	<input type="radio"/> 1200	<input type="radio"/> 2400	<input type="radio"/> 4800
	<input type="radio"/> 9600	<input type="radio"/> 19200	<input checked="" type="radio"/> 38400
Parity	<input checked="" type="radio"/> None	<input type="radio"/> Odd	<input type="radio"/> Even
Databits	<input type="radio"/> 7	<input checked="" type="radio"/> 8	
Stopbits	<input checked="" type="radio"/> 1	<input type="radio"/> 2	
Mode	<input type="radio"/> Data	<input checked="" type="radio"/> Control	<input type="radio"/> Modem
	<input type="radio"/> T120		
Data Port 2			
Previous Menu			

Data mode

Provides a transparent data channel. This channel can be used for many different purposes such as file transfer, application sharing and more. When using this mode, it is necessary to have a TANDBERG system at the far end.

Control mode

The control interface provided by the Dataport supports a subset of the Hayes command set as well as a comprehensive set of system specific commands.

This mode maintains communication with the Dataport's command interpreter at all times. All features available from the hand-held remote control can be accessed through the dataport.

Modem

Allows you to control the system externally via a PC as in Control Mode. Once a call is established, Dataport 1 will automatically switch to Data mode. When the call disconnects, Dataport 1 switches back to Control Mode.

T.120

Provides a data channel supporting the T.120 standard for data communication. Using T.120 software on your PC, you can communicate with other T.120 systems using your PC and your system.

Dataport 2

Data Port 2			
Baudrate	<input type="radio"/> 1200	<input type="radio"/> 2400	<input type="radio"/> 4800
	<input checked="" type="radio"/> 9600	<input type="radio"/> 19200	<input type="radio"/> 38400
Parity	<input checked="" type="radio"/> None	<input type="radio"/> Odd	<input type="radio"/> Even
Databits	<input type="radio"/> 7	<input checked="" type="radio"/> 8	
Stopbits	<input checked="" type="radio"/> 1	<input type="radio"/> 2	
Mode	<input type="radio"/> VISCA	<input checked="" type="radio"/> Auto	
Previous Menu			

Dataport 2 is dedicated to the main camera and will not be available in standard configuration.

The Codec will automatically detect WAVE cameras. If you are using a camera supporting the VISCA protocol, select '**Mode: VISCA**'. The Dataport 2 settings will then be enabled.

If '**Mode: Auto**' and no camera is connected to the Dataport 2, the Baudrate, Parity, Databits and Stopbits settings will be enabled.

For more details on connecting to the Dataport, see 'Peripheral Equipment'.

Language

The system supports 11 different languages for its on-screen menus.



Select the preferred language, and press OK to save.

Software Options

The system requires a valid option key to activate Security (contains Secure Conference AES), MultiSite and/or Presenter functionality. A restart of the system is required after entering a new option key. If the option key is invalid, the original key will be used.

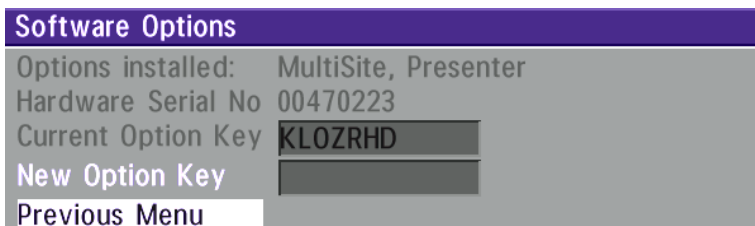

The following options are available

1. No option
2. NPP (Presenter)
3. MultiSite + NPP
4. Security + NPP
5. Security + NPP + MultiSite

Diagnostics

Allows testing of individual system components and displays the current system settings.

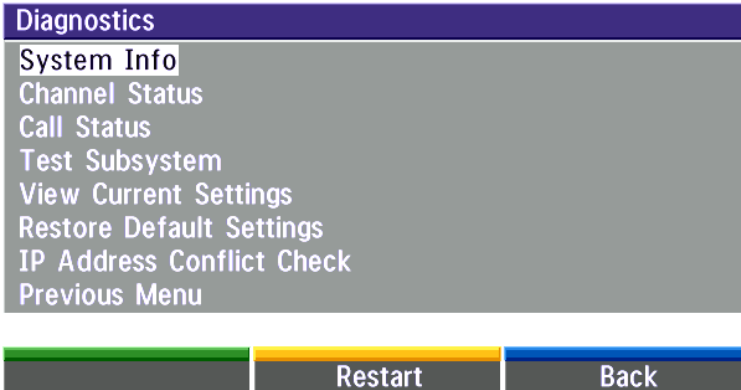

System info



Select '**System Info**' to view system numbers, line status, software version and other useful information.

Channel status

Comprehensive information about the call progress is available through the Channel Status window. This window indicates the various stages each B-channel goes through whilst establishing a connection.

Status - BRI	Comments
Idle	the channel is idle
Calling	when calling — the network has acknowledged the call
Connected	when connection is established
Sync	when the channels are synchronised
Active	when all available channels are connected
Releasing	waiting for the network to confirm a release of the call
Released	when disconnected - the network has acknowledged the disconnection

Channel Status		
Idle.		
1	B1	Idle
	B2	Idle
2	B1	Disabled
	B2	Disabled
3	B1	Disabled
	B2	Disabled

Call Status Back

TIP PRESS **MENU** AND THEN '**CALL STATUS**' TO BRING THIS MENU UP WHEN NOT IN THE MENU SYSTEM.

The numbers used to call out to the far end are shown in the window. If an error occurs a cause code will be displayed on the right hand side of the window.

Cause codes

The most common cause codes (for ISDN) are:

- 1 - Unallocated (unassigned) number
- 2 - No route to specified transit network (WAN)
- 16 - Normal clearing
- 17 - User busy
- 18 - No user responding
- 21 - Call rejected
- 28 - Invalid number format (incomplete number)
- 29 - Facility rejected
- 31 - Normal, unspecified
- 34 - No circuit/channel available
- 41 - Temporary failure
- 58 - Bearer capability not presently available
- 65 - Bearer service not implemented
- 69 - Requested facility not implemented
- 81 - Invalid call reference value
- 88 - Incompatible destination
- 100 - Invalid information element contents
- 102 - Recovery on timer expiry
- 127 - Internetworking, unspecified
- 255 - TANDBERG specific. undefined cause code

Call status

Comprehensive information about the call is available through the Call Status window. The menu has two columns, one for transmitted and one for received audio/video/data information. If Duo Video or MultiSite is used, pressing the LEFT/RIGHT keys will show one page per connected site.

Calls: H320	Transmit	Receive
System Name: 8620		
Call rate (kbps)	384.0	384.0
Video protocol	H263+	Off
Audio protocol	G722	G722
Data protocol	None	None
Video format	CIF	None
Video rate (kbps)	325.6	0.0
Audio rate (kbps)	56.0	56.0
Data channel/rate	Off/0.0	Off/0.0
Encryption status	AES	AES
Encryption check code	5048 EB21	2B2C 1ABE
No incoming video.		
Channel Status		Back

Please contact your TANDBERG representative for further information.

Restore defaults

You may restore all system settings to the factory default using this function.

NOTE THIS DEFAULT SETTING WILL NOT AFFECT YOUR CALL DIRECTORY INFORMATION, NETWORK TYPE, LINE SETUP NUMBERS OR YOUR SPID NUMBERS

Test subsystem

You can test the different subsystems of your videoconferencing equipment.



Far End Loop (ISDN only)

SetLocal: This system will loop all incoming audio and video.

- The far end will see its own video and hear its own audio.
- The local side will see and hear the far end.

An on-screen indicator will indicate 'Local Loop'.



RequestRemote: A request will be sent to set the far end in loop.

- The far end will see and hear the local side (varies depending on implementation of loop functionality).
- The local side will see its own video and hear its own audio (if the far end supports loop).



If 'Far End Loop' is set to 'RequestRemote' while in a call and the call is subsequently disconnected, 'Far End Loop' will be set to 'Off'.

System Selftest

The system performs a check to determine internal hardware integrity. Test Network is useful when you want to check if your network connection is active.

View current settings

This window will display all the system settings. Use the arrow keys to scroll through the list.

IP Address Conflict Check

The codec will give a warning if there is an IP conflict. This check may be initiated by the user by selecting IP Address Conflict Check.

Peripheral Equipment

Using the optional peripheral devices outlined in this chapter and the many others available, you will be able to build your own applications for use with the TANDBERG 2500, thereby better integrating the system into your business environment.

This chapter will explain how to connect peripheral equipment to your system. First of all however, we recommend you examine the figure below detailing the available connectors on the back of the system Codec.

Interfaces

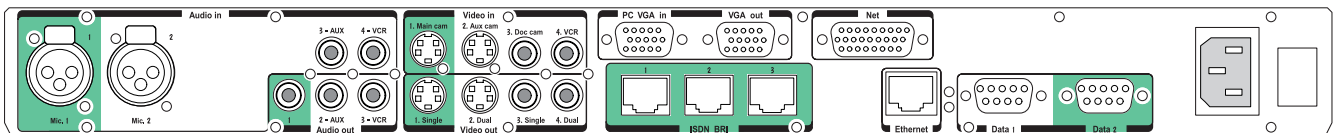
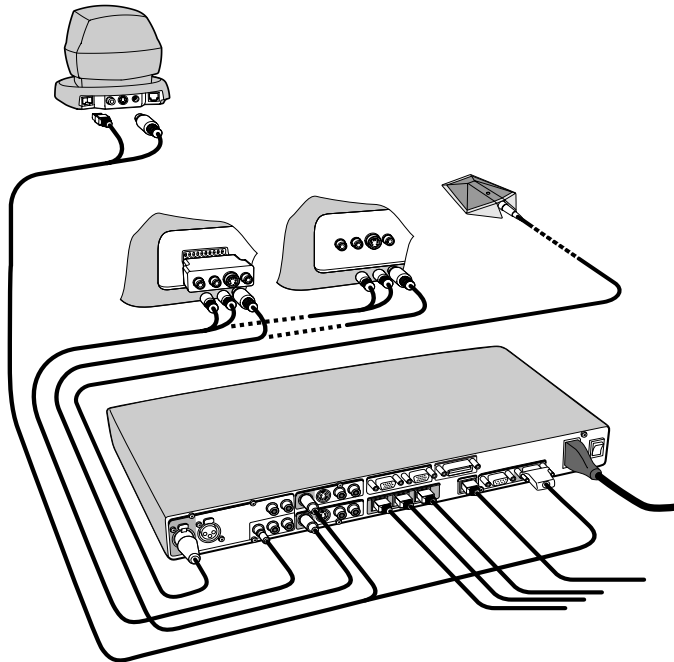

5 Video Inputs

- 2 video inputs supporting S-Video through Mini-DIN connectors.
- 2 video inputs supporting composite signals through RCA connectors.
- 1 VGA input supporting resolutions VGA(640x480), SVGA(800X600) and XGA*(1024x768) (auto sensing).

The standard camera uses one of the S-Video inputs. The system will automatically adapt to a PAL or NTSC input.

5 Video Outputs

- 2 S-Video outputs, Mini-DIN connectors.
- 2 composite video outputs, RCA connectors.
- 1 VGA output supporting resolutions VGA(640x480), SVGA(800X600) and XGA*(1024x768).

The first Mini-DIN connector and the first RCA connector provide main video (incoming/outgoing video and menus). The two other connectors provide selfview/still image/Duo Video. The S-Video outputs are used by default by the monitors. The outputs are always active.

The format of the output will be either PAL or NTSC depending on your country's standard video format.

4 Audio Inputs

- 2 microphone inputs (balanced, 24V phantom powered) via XLR connectors.
- 2 audio inputs (line level) via RCA connectors.

All audio inputs are active by default. For further information, refer to section 'Audio Settings'.

3 Audio Outputs

- 1 output (line level) via RCA connector providing audio from far end in addition to dial tones. This output is used either by the monitor or by the Natural Audio module (if installed).
- 1 AUX output (line level) via RCA connector providing a mixed signal between audio from the local side (except from the AUX input) and audio from the far end. This output is intended for connection to a telephone add-on system.
- 1 VCR output (line level) via RCA connector providing a mixed signal between audio from the local side (except from the VCR input) and audio from the far end. This output is intended for connection to a VCR.

* E2 only

Dual Monitor

It is possible to install the system in a Dual Monitor configuration.

The Dual Monitor option consists of an additional monitor, bigger cabinet top-plate and associated cabling.

The Dual Monitor can be used to show full screen selfview, snapshots and Duo Video.

To use the system in the Dual Monitor configuration:

- Connect 'Video Out 2' (preferably) otherwise 4 on the system to a video input on the dual monitor.
- Set **'Dual Monitor: On'** in **'Utilities'** menu.

Alternatively you can use a PC monitor as your second monitor:

- Connect 'VGA Out' on the system to your PC monitor.
- Set **'VGA Out: Dual'** in **'VGA Settings'** menu.

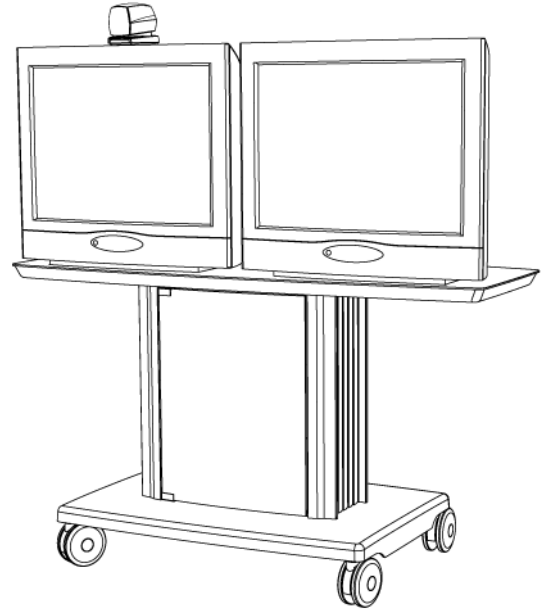

XGA monitor*

The TANDBERG 2500 can be delivered with XGA monitors as an option. This will allow you to display XGA images on your Dual Monitor.

- Connect 'VGA Out' on the system to your XGA monitor.
- Set **'VGA Out: Dual'** in **'VGA Settings'** menu.
- Connect the control cable from Dataport1 to the control input on the XGA monitor. The system will select video input or XGA input based on signals sent from the system.

NOTE IT IS NOT POSSIBLE TO USE T.120 IF THE XGA CONTROL CABLE IS CONNECTED SINCE DATAPORT 1 IS OCCUPIED.

* - Optional

Document camera

A document camera can be used for showing text, diagrams and a variety of graphical material as well as small three-dimensional objects. To use a document camera with your system:

- Connect the document camera to the DocCam input on the Codec.
- Press **Doc CAM** on the remote control to select the document camera as the video source.
- See also 'Presentations' for easy access to still image transfer from document camera.

If you want to use S-Video from the document camera, you can connect the document camera to the Aux input on the codec and set '**Document Camera: Video2**' in '**Video Settings**'. Pressing **Doc CAM** on the remote control will then activate the S-Video input on the codec.

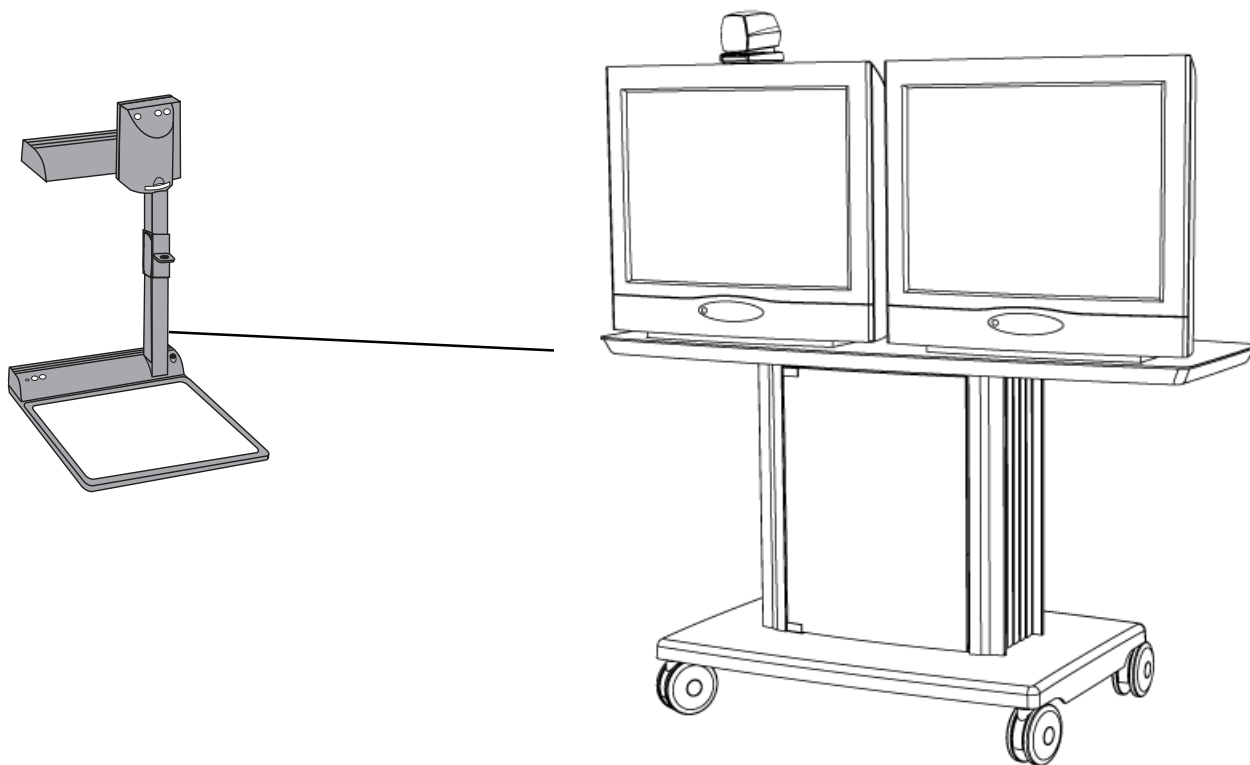

Multiple controllable cameras

Attaching multiple cameras to one system expands visibility and is useful in large group applications.

The system is able to control up to 4 WAVE-cameras. Optional WAVE cameras are supplied with the necessary cabling. In addition, an external power supply is needed.

WAVE-camera number two must be connected to video input 2, camera number three must be connected to video input 3, and so forth.

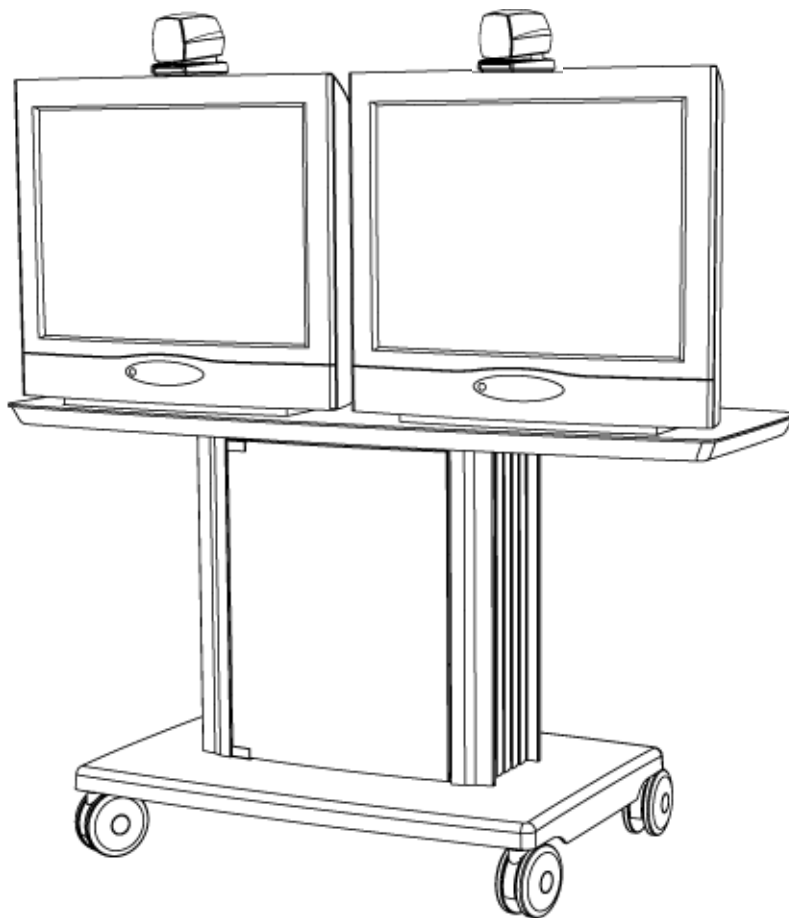

AudioScience microphone

TANDBERG's award-winning AudioScience microphone is a ceiling-mounted, wide coverage, boundary microphone, that can eliminate the need for table microphones. It is designed to pick up the audio from all conference participants seated within its pick-up area, defined by a quarter-sphere of approximately 14 foot (4.25m) radius extended in front of, and to the sides of the microphone.

Please contact your TANDBERG representative for further information.

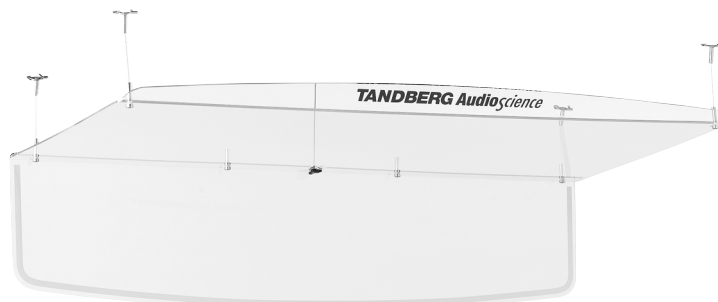

Tracker

The Tracker is a small infrared remote control device made to be used to steer the system camera to any desired location within the room. Typically, several Trackers would be used with each system.

Each Tracker has two buttons:

- One button to point the camera at a specific person/location.
- One button to point the camera at all participants.

Beneath the battery in the tracker, there is a switch which can be set to 16 different positions between 0 and F. For preset 10 to 15, the numbers 9 to F should be selected. Please refer also to 'Presets' in the 'General Use' - section.

For more information, contact your local TANDBERG representative.



Video Cassette Recorder (VCR)

VCR - Playback

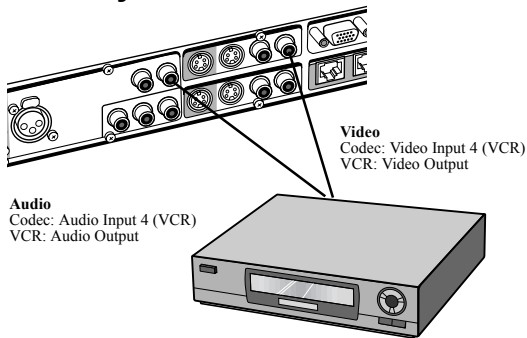
TIP

TO SIMPLIFY CONNECTING A VCR, THE NECESSARY CONNECTORS ARE MARKED 'VCR'

For playback, connect a cable between Video Out on the VCR and 'VideoIn 4 (VCR)' on the system. Connect a cable between Audio Out on the VCR and the VCR audio input on the system.

VCR



Press **VCR** to activate the VCR input.

Make sure that 'Audio In 4 (VCR)' is On (see 'Audio Settings'). If audio from VCR is too low, this level can be adjusted in 'Audio Settings', 'Inputs', 'Level Settings'. The audio from the VCR will be audible in the local speaker system.

The audio from the VCR and your microphone(s) will be mixed and sent to the far end. When a person talks on either local or far end, the VCR audio level will be reduced to make it easier to comment on a video recording when '**Audio Settings**', '**Mix Mode: Auto**'.

VCR - Recording

When recording, the VCR will record the video as it appears on the main monitor, the local audio and the audio from the far end.

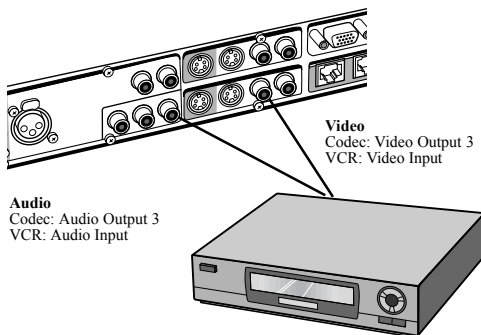

When recording a videoconference, connect a cable between 'VideoOut 3' on the system and Video In on the VCR. Connect a cable between 'AudioOut 3' on the system and Audio In on the VCR.

Telephone Add-On

A telephone add-on is used when you want to include a telephony participant in the meeting. You can also use this functionality when you want to have conference participants in an adjacent room with its own microphone and speaker system.

The telephone add-on connectors are marked AUX on the system (audio input 3 and audio output 2). Audio output 2 provides a mixed signal between local and far end.

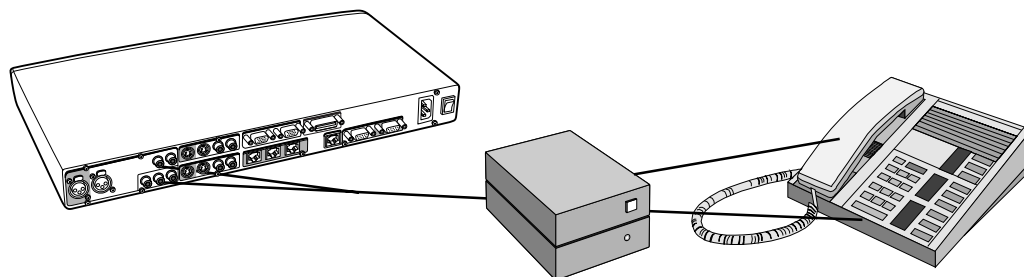

TIP THE MULTISITE HAS THE ABILITY TO ADD UP TO 4
ADDITIONAL TELEPHONE CALLS USING ISDN.

Extra fixed cameras

You can connect extra fixed cameras to your system, for example, a whiteboard camera.

Connect the video output of the additional camera to one of the available Video in sockets on the system.

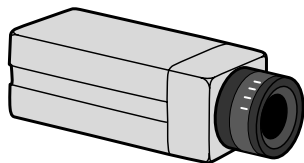

PC applications

A PC can be connected to the system in two different ways.

- Through the PC Presenter (VGA input), see section 'PC Presenter'.
- Through an RS232 data cable.

T.120 and other PC applications

A PC can be connected to the system using a serial cable. This will enable interactive editing, file transfer and application sharing between two computers.

Appropriate communication software should be used (for example: Microsoft NetMeeting, Intel ProShare Premier, Windows HyperTerminal, Procomm Plus and so forth.)

The system has been specially designed to work with interactive programs and includes a data channel that can send and receive data to and from the far end at speeds of up to 38,400 baud.

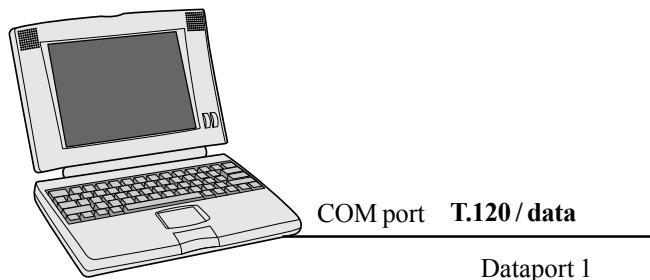

NOTE WHEN THE DUAL XGA MONITOR* IS INSTALLED, THIS APPLICATION WILL NOT BE AVAILABLE SINCE THE DATAPORT 2 IS BUSY.

PC SoftPresenter

A PC image can be displayed on the system using PC SoftPresenter.

For further information, see 'PC SoftPresenter' in 'General use'.

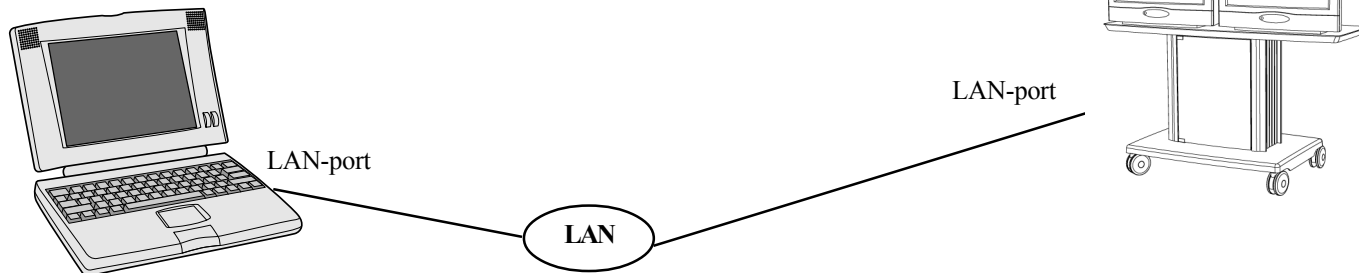

Additional microphones

If your environment is such that you require more microphones for your room, e.g. you have a whiteboard at a distance from your table microphones, it is possible to connect additional microphones to your system.

You can connect up to three microphones to your system. The connectors are marked Mic1, Mic2 and Mic3. The connected microphones will by default be mixed.

When more than one microphone is connected you have the option to use the Voice Activate Camera Positioning feature.

Appendices

Appendix 1: Connecting the system to ISDN using NT1 network adapters

Connecting

Connect the first ISDN cable from ISDN 1 on the codec to the S-interface on your first NT1 network adapter. Connect the other ISDN cables to the appropriate NT1 network adapters.

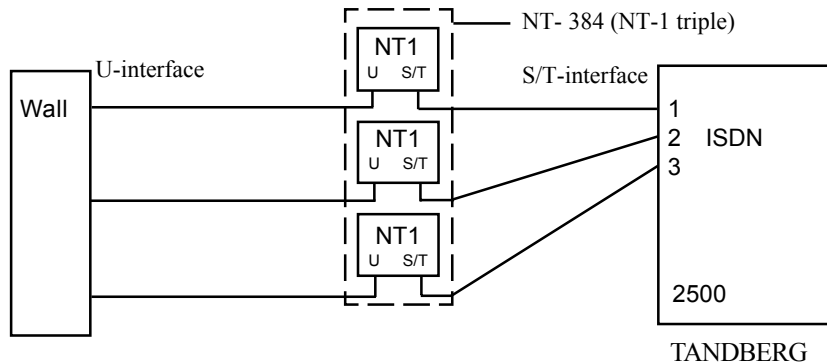

Connect the U-interface of your NT1 adapter to the line provided from your network provider. TANDBERG can provide NT-adapters.

For convenience the NT1 adapters could be placed inside the cabinet. If needed, use the shorter ISDN cable (RJ45 connectors) delivered with the NT1 between the codec and the NT1 and the longer ISDN cable between the NT1 and the connector (RJ45) at the wall socket.

Configuring

The configuration of the codec is performed in the same manner as described in ISDN BRI Settings.

The NT1 should be powered up and you should check that the network is active. Please check your NT1 User Manual.

Appendix 2: Connecting the system to the Switched 56 network

Using Telesync TS-256 SW56/ISDN adapter

Connecting the system to the SW56 network using a Telesync Adapter is described below.

NOTE: There are different Telesync Adapters for different configurations of SW56 networks. The network types tested with the system are SW56 2Wire and 4Wire.

Connecting

Connect the system ISDN1 cable to the BRI S/T interface on the Telesync Adapter. Connect the two SW56 cables from the Telesync adapter Line 1 and Line 2 to the SW56 network.

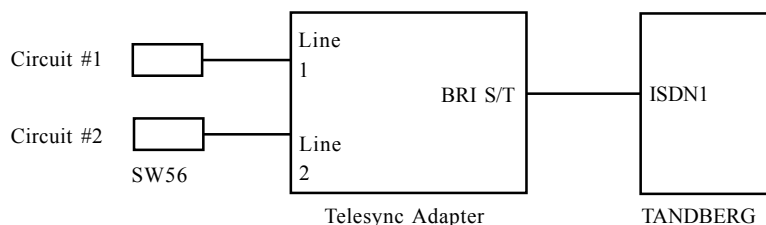

Configuration of Telesync Adapter

No configuration of the Telesync Adapter is necessary.

Configuration of the system

Select network type to 'National ISDN'.

LINE 1 SETUP

NUMBER1: program with number from the first SW56 line
 NUMBER2: program with number from the second SW56 line
 SPID1: program with number from the first SW56 line
 SPID2: Leave blank

LINE 2 SETUP

NUMBER1: number from the third SW56 line
 NUMBER2: number from the fourth SW56 line
 SPID1: Leave blank
 SPID2: Leave blank
 And so on for the other lines.

How to call

Important: Use the Quick key 'Set Restrict (56k)' in the Quality menu to specify a restricted call (56k) when you dial a number.

Example:

One number dialing enter: Number: 1703111222 (56k)

Two number dialing enter: Number: 1703111222 (56k)
 2nd: 1703111223

Appendix 3: Environmental considerations

This section explains how to carry out basic adjustments and simple tests to ensure that you send and receive the best possible image and audio quality when using your system.

Iris control and lighting

By default the system camera will use an automatic iris to compensate for changes in lighting. In addition to this feature you may further assist the system to maintain the best possible image quality by paying special attention to environmental lighting and background colors as described below. Remember the system will send live images of yourself *and* your immediate surroundings.

- Avoid direct sunlight on the subject matter i.e. yourself, the background or onto the camera lens as this will create harsh contrasts.
- If light levels are too low you may need to consider using artificial lighting. As described above, direct illumination of the subject matter and camera lens should be avoided.
- When using artificial lighting, 'daylight' type lamps will produce the most effective results. Avoid colored lighting.
- Indirect light from shaded sources or reflected light from pale walls, often produces excellent results.
- Avoid harsh side lighting or strong light from above. Strong sunlight from a window or skylight may put part or all of the subject matter in shadow or cause silhouetting.
- If you still have problems with the iris and lighting, manual adjustment of the camera parameters might help - see **Video Settings**' menu.
- Dim scenes can also be improved by manually adjusting the camera brightness setting.

Background

The appearance of the picture background is very important but easily overlooked. It is important to remember that the camera also shows what is behind you when in a videoconference. To ensure a suitable background we recommend you consider the following:

- Use a neutrally colored background with a medium contrast and a soft texture, e.g. a plain curtain with no heavy patterns or strong colors that may adversely tint the whole scene.
- Avoid moving backgrounds such as curtains blowing in a draught, moving objects, or people walking behind as this may both reduce image quality and distract the attention of the calling party.
- Do not place the camera facing a doorway.

Loudspeaker volume

The audio system will use the loudspeakers built into the TV monitor. The volume of the audio system is controlled by the Volume Control keys on the system hand-held remote control.

The default volume level can be set by adjusting the volume on the TV monitor using the TV monitor's own remote control.

Guidelines for setting up videoconferencing rooms

The following are a set of guidelines to consider when either building a videoconferencing room, or using an existing room for videoconferencing.

Lighting:

- Low Contrast desired for light intensity. No dark spots.
- Intensity @ table 800 - 1400 Lux as measured with an Incident light meter.
- Block sunlight from entering room.

Seating Area (Table):

- Should allow all participants to see Monitors.
- Should allow camera to “see” all participants.
- Non-shiny non-patterned preferably light grey surface (if table used).

Walls:

- Color: Generally high contrast color desired. Light blue is commonly used.
- Acoustically reflective surfaces (such as glass or concrete) should be covered with curtains or sound treatment.

Audio:

- Noise Floor preferred less than 44dBC.
- Reverb Time .3 to .5 sec.

Ventilation:

- Keep in mind Noise Floor.
- Velocity = Noise. Therefore keep velocity of air low.

Room:

- Should be located away from noise
- Should not have windows
- Doors should be located off camera

How to prepare a typical room for videoconferencing

The diagram below shows a typical room designed to obtain the best results when using the system.

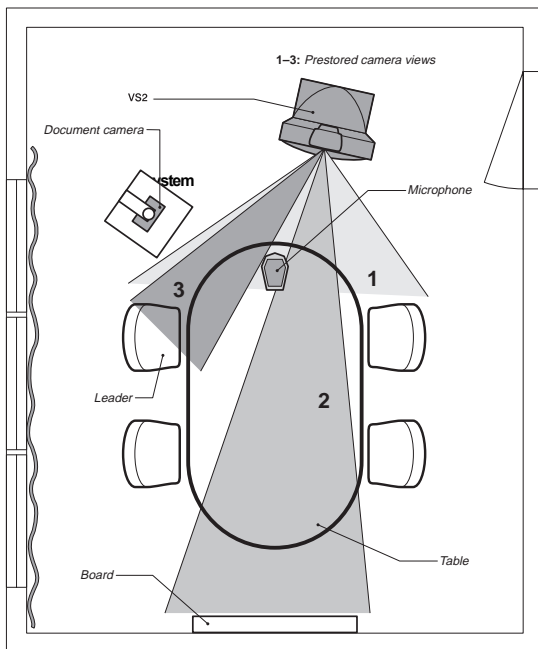

The microphone should be placed at the front of the table to ensure that all speech will be detected. The best position for the microphone is at least 2 meters (6.5 feet) in front of the system on a plain, flat table with at least 0.3 meters (12 inches) of table in front of the microphone.

The document camera should be close to the chair person or a designated controller of the document camera for ease of use. (Remember to arrange all the peripherals so that one participant can reach each of them to point, change the display, tape, and so forth).

The camera supports up to 15 pre-stored camera positions.

The illustration shows three possible camera positions; one for all the participants, one for the whiteboard and one for the main speaker. The remaining presets are then available for other peripheral equipment, for example: a VCR.

Position the system in such a way as to avoid the possibility of somebody inadvertently walking into the camera's field of view when entering the room. Other than the conference participants, there should be no moving items in the sent image.

Appendix 4: Using the file system

It is possible to access a file system within the TANDBERG system by using ftp:

DOS-window: ftp <IP-address of codec>, or

Web-browser: ftp:// <IP-address of codec>

Description of the different files

all.prm - all settings in the system (including directory)
dir.prm - directory entries
event.log - logs fault situations etc.
sw.pkg - the system software
globdir.prm - file containing up to 400 entries. These entries can not be edited from the TANDBERG Videoconferencing system, but can be edited as a text-file.

Files accessible only by 'ftp get /tmp/snapshots/xxx.jpg' or 'http://<IP-address of codec>/tmp/snapshots/xxx.jpg':

main.jpg - Snapshot of current stream if MultiSite.

local.jpg - Snapshot of selfview

farend.jpg - Snapshot of decoded stream if point-to-point.

duovideo.jpg - Snapshot of the encoded stream if transmitting DuoVideo, the decoded stream if receiving DuoVideo.

Description of the different folders

user - a folder to be used for custom logos etc.

remote - a folder used for software upgrade of the far end TANDBERG system

What can be done by using the file system?

- software upgrade of the far end TANDBERG system (B3 or above) via ISDN
- upload of custom logos

Software upgrade

- Connect to the system you want to upgrade using ISDN.
- Copy the software file to a folder on your harddisk.
- Open a DOS-window and go to this folder.
- Type ftp <IP-address of your local codec>.
- Enter password: <Release Key of far end system>
- Go to the remote folder, type "cd remote"
- Upload the software file, type put <s0xxxxxx.pkg>
- Wait until the following is shown:
226 Closing data connection.
5437569 bytes sent in 808.01 seconds (6.73 Kbytes/sec)
ftp>
- Restart the far end codec.

The far end system should now be upgraded. For further information, please contact your TANDBERG representative.

Custom logos

- Go to the folder where your logo is located.

NOTE LOGO MAX SIZE: E2: 704x480, B7: 320x200, FILE-FORMAT: JPG. IF THE FILE IS TOO LARGE, NO LOGO WILL BE DISPLAYED.

- Type ftp <IP-address of your local codec>.
- Go to the user folder, type "cd user"
- Upload the logo, type put <startup.jpg>

The new logo will be displayed the next time you restart your system.

Appendix 6: Security

The TANDBERG Videoconferencing Unit has several features both to protect from unauthorized use and system access:

Access Code:

When 'Access Code' is enabled, the user will be asked to enter an access code before he/she is able to make a call.

The system will verify if the entered access code is valid by checking the code with the allowed codes listed in the 'access.txt' file on the ftp-server in the codec.

If no 'access.txt' file is uploaded to the codec, registration of the code will be done without validation. E.g. you can enter whatever code you want and have access to the system.

The 'access.txt' file is a plain text file with one line per access code as shown below:

```
1234
1250
A1
B2
ABC
```

To upload this file to the codec, follow these steps:

- Open a DOS-window and go to the folder where the 'access.txt' file is located.
- Type ftp <IP-address of your local codec>.
- 'User:', press Enter or enter IP-password.
- Type "bin" and press Enter
- Go to the user folder, type "cd user".
- Upload the 'access.txt' file, type 'put access.txt'.
- Exit from ftp, type 'bye'.

Menu Password:

Access to the menu system on the TANDBERG Videoconferencing unit can be controlled using password protection. This is done by using the following dataport command:

menupassword set <pin-code>. The pin-code should be maximum 5 - five digits. To erase the menu password, enter an empty pin-code.

Streaming password

By setting a streaming password in the streaming menu on the TANDBERG codec, a password have to be entered on the streaming client to be able to see the videostream from the TANDBERG Videoconferencing Unit.

IP Password

By setting a IP Password on the TANDBERG codec, all access to the system using IP (Telnet, FTP, WEB) requires a password. This password can be enabled from telnet or dataport using the command: `ippassword <ip-password>`. The default IP password is 'TANDBERG'.

To remove this password, use the command: `ippassword ""`. From telnet, this is only possible by first entering the correct password.

Services

The different IP services on the TANDBERG codec - FTP, Telnet, HTTP, SNMP and H.323 can be disabled to prevent access to the system. By using the commands below, the services can be independently enabled/disabled:

```
services <telnet/ftp/http/h323/remote-software> <enable/disable>
```

```
services <snmp> <read-only/enable/disable>
```

```
services <telnetchallenge> <enable/disable> [port]
```

SNMP Security alert

This function will notify any Management Application (such as TMS - TANDBERG Management Suite) if anyone tries to perform Remote Management on the TANDBERG Codec using a illegal password. The Security alert that is sent to the Management Application will contain information about the IP address and the service (WEB, Telnet, FTP) being used for the attempt.

If TMS is used, email notifications or alarms about the attempt can be sent to specified persons.

Encryption

All TANDBERG systems support both AES* and DES encryption. By default this feature is enabled such that when connecting with any other video system or MCU, a TANDBERG system will attempt to establish a secure conference using AES* or DES encryption. The TANDBERG system will attempt this for both IP and ISDN connections. Where a remote system or MCU supports encryption, the highest common encryption algorithm will be selected on a port by port basis.

The type and status of the encryption negotiated is indicated by padlock symbols and on-screen messages. Encryption on the TANDBERG systems is fully automatic, and provides clear security status indicators;

An open padlock indicates that encryption is being initialized, but the conference is not yet encrypted.

Single padlock indicates DES encryption.

Double padlock indicates AES encryption.

In addition to on-screen indicators the 'Call Status' menu provides two information fields regarding call encryption. The first field is the 'Encryption Code' which will identify either 'AES' or 'DES'. The second field is the 'Encryption Check Code' and is comprised of an alphanumeric string. This string will be the same for systems on either side of an encrypted conference. If the Check Codes do not match this would indicate that the call has been exposed to a 'Man In The Middle' attack.

When a TANDBERG codec with MultiSite functionality hosts a conference, the highest possible encryption algorithm will be negotiated on a site by site basis. MultiSite conferences can therefore support a mix of AES and DES encrypted endpoints in the same conference.

A conference will only be as secure as its 'weakest link'. Even though conference participants may have negotiated and be running AES encryption, if just one participant has negotiated DES encryption, the AES system will display the single padlock symbol to advise all users of the lowest encryption mechanism currently in effect.

All TANDBERG endpoint supporting DES encryption can upgrade to AES encryption by applying TANDBERG's AES Encryption option. Please contact your TANDBERG representative for more information.

The standards supporting the encryption mechanisms employed by TANDBERG are: AES*, DES, H.233, H234 and H.235 with extended Diffie Hellman key distribution via H.320, H.323 and Leased Line connections.

NOTE THE TANDBERG AES IMPLEMENTATION IS VALIDATED AS CONFORMING TO THE **ADVANCED ENCRYPTION STANDARD (AES) ALGORITHM**, AS SPECIFIED IN [FEDERAL INFORMATION PROCESSING STANDARD PUBLICATION 197, ADVANCED ENCRYPTION STANDARD](#), BY THE THE NATIONAL INSTITUTE OF STANDARDS AND TECHNOLOGY (NIST)

* - Optional feature

Appendix 6: Declaration of Conformity

EC DECLARATION OF CONFORMITY

MANUFACTURER: TANDBERG
TYPE NUMBER: TTC60-03
MODEL NUMBER: TANDBERG 2500
DESCRIPTION: Video Conferencing Unit
DIRECTIVES: LVD 73/23/EEC
 This equipment complies with. EMC 89/336/EEC
 R&TTE 99/5/EEC
HARMONISED STANDARDS: EN 60950 (1992) A1/A2/A3/A4/A11
 Applied in order to verify EN 55022 : 1994
 compliance with directives. EN 55024 : 1998
 EN 61000-3-2 : 1995 A1/A2
 EN 61000-3-3 : 1995
 CTR3 Layer 1, 2 and 3

**TEST REPORTS/
 CERTIFICATES ISSUED BY:**

LVD (Nemko AS)	Report/Certificates No. 200014214 200234146 200231224
EMC (Nemko AS)	200103335
R&TTE (Comlab)	02/214/3 02/214/4

**TECHNICAL CONSTRUCTION
 FILE NO.:** D12212
 Rev.03: Test reports added

**YEAR WHICH THE
 CE-MARK WAS AFFIXED:** 2000

AUTHORISED REPRESENTATIVE

NAME: PER H. KOGSTAD
TITLE: Executive Vice President

Date of issue

16.09.2002

EC DECLARATION OF CONFORMITY

MANUFACTURER: TANDBERG
TYPE NUMBER: TTC6-07
MODEL NUMBER: CODEC 2500
DESCRIPTION: Video Conferencing Codec
DIRECTIVES: LVD 73/23/EEC
 This equipment complies with. EMC 89/336/EEC
 R&TTE 99/5/EEC
HARMONISED STANDARDS: EN 60950 (1992) A1/A2/A3/A4/A11
 Applied in order to verify EN 55022 : 1994
 compliance with directives. EN 55024 : 1998
 EN 61000-3-2 : 1995 A1/A2
 EN 61000-3-3 : 1995
 CTR3 Layer 1, 2 and 3

**TEST REPORTS/
 CERTIFICATES ISSUED BY:**

LVD (Nemko AS)	Report/Certificates No.: 200231224
EMC (Nemko AS)	200103335
R&TTE (Comlab)	02/214/3 02/214/4

**TECHNICAL CONSTRUCTION
 FILE NO.:** D13011

**YEAR WHICH THE
 CE-MARK WAS AFFIXED:** 2002

AUTHORISED REPRESENTATIVE

NAME: PER H. KOGSTAD
TITLE: Executive Vice President

Date of issue

16.09.2002

Doc ref. : D 13011 REV.01

Doc ref. : D 12212 REV.03

Index

A

Access Code 23, 84, 110
 Add Duo Video 37
 Add MultiSite Entry 29
 Add New Entry 28
 Adding an extra site 41, 42
 Additional microphone 103
 Adjusting volume 30
 Advanced call quality 48
 Advanced ISDN settings 72
 Advanced use 46
 AES 85, 112
 Alert Speaker 64
 Audio
 inputs 58
 outputs 60, 95
 quality 47
 setup 58
 sources 58
 AudioScience microphone 99
 Auto BRI Config 70
 Autofocus 32
 Automatic Gain Control 63

B

Background 106
 Basics 21
 Battery handling 3
 Boot up Logo 109

C

Cabinet 11
 Cable Specification, V.35 75
 Cables 15
 Call
 making a LAN call 22
 making a video call 22
 restricted 24
 Call control 74

Call Quality menu 47
 Call Settings 84
 Call status 92
 Camera 10
 controlling 32
 extra camera 101
 tracking modes 65
 Cause codes 91
 Chairman functionality 54
 Channel status 90
 CIF 48
 Closed Captioning 44
 Codec 10
 Connecting cables 15
 Continuous Presence 54
 Control mode 87
 Copyright 3
 Correcting keying mistakes 26

D

Data mode 87
 Dataport configuration 87
 Declaration of Conformity 110, 113
 DES 85, 112
 DHCP 82
 Diagnostics 90
 Dial in to MultiSite 42
 Dialing 22
 Digital Clarity 49
 Directory
 Add New Entry 28
 Edit Entry 28
 Name 28, 29
 Disconnecting sites 42
 Do not disturb 31
 Document Camera 65
 Document camera 97
 Downspeeding 22
 Dual Monitor 36, 96
 Duo Video 37
 Duo Video / Still Image source 50
 Duo Video Mode 49
 Duo Video Quality 49

E

Echo Control 61
 Edit/Delete Entry 28
 Encryption 85, 112
 encryption 39
 Ending a call 26
 Environmental Issues 3
 Ethernet Speed 83
 Euro ISDN cause codes 91
 External network settings 74
 Extra cameras 101

F

Far end camera control 35, 51
 FECC 35
 file system 108
 Floor to site # 57
 Focus 66

G

G.711 48
 G.722 48
 G.722.1 48
 G.728 48
 Gateway 82
 General use 30
 Getting started 20
 Graphics
 Receiving 36
 Sending 36
 Guidelines for making rooms 107

H

H.261 48
 H.263 48
 H.264 47, 48
 H.281 35
 H.323 Ports 80
 H.331 48
 How to prepare a typical room for videoconferences 107
 HumFilter 61

I

Incoming MCU calls 84
Installation 13
Intelligent Call Management (ICM) 10
Interfaces 94
Introduction 7
IP Address Conflict Check 93
IP Password 111
IP-address 82
IP-subnet mask 82
Iris control and lighting 106
ISDN switch type 70
ISDN-BRI Settings 70

K

Key Tones 64

L

Level Settings
 Outputs 60
Line setup 71
Logo 109, 112
Loudspeaker volume 106

M

Main camera 10
Making a call 22
MCU services 54
Menu Access 110
Menu Access Code 53
Menu Password 110
Menu structure 8
Menu system 46
Microphone
 levels 59
 on/off 30
Monitor configuration 16
Motion 47
Moving camera 32
MSN (Multi Subscriber Number) 73
Multiple cameras 98

Multipoint Control Unit (MCU) 54
MultiSite (Built-in) 39
MultiSite cascading 40

N

NAT Address 80
Natural Video 7, 47
Network configuration 69
Network Profiles 86
NT1 16
NTSC 95

O

On Screen Symbols 31

P

PAL 95
Parallel dial 73
Password 77
PC 65, 102
PC applications 102
PC Presenter 43
PC SoftPresenter 43, 102
Peripherals 94
Phantom power 58
Picture-in-Picture 30
PIP 30
Precautions 13
Presentations 49
Preset buttons 34
Presets
 selecting 34
 storing 34
Production of products 3

Q

Quality 24
Quick keys 21

R

Release chair 57
Release floor 56
Remote control 11

Request floor 56
Requesting a still image 36
Restart 83
Restore Audio Defaults 64
Restore defaults 92
Restricted call 24

S

Seating Area 107
Security 110
Selecting network 25
Selecting video sources 32
Send Own Numbers 74
Services - security 111
Sharpness 47
Snapshot 49, 50
snapshot 49, 50
Snapshots 45
SNMP Agent 83
SNMP Community 83
SNMP Manager 83
SNMP Security alert 111
SNMP Trap Host 83
SNMP traps 83
SoftMux 22
Software Options 89
Start-up 20
Status Format 48
Still image
 filter 50
 receiving 36
 requesting 36
 sending 36
 viewing 36
Storing presets 34
sub-address 23
Subaddress 72
System configuration 17
System info 90
System overview 9
System set-up 69
System start-up 20

T

T.120 87
T.120 and other PC applications 102
Table microphone 12
Take chair 57
Telephone Add-On 101
Terminal ID 56
Terminal settings 69
Terminate meeting 57
Text Chat 44
To adjust the volume 30
To answer a call 26
To call a terminal with a SUB-address 72
To connect a PC to Dataport 1 87
To end a call 26
To enter/leave the menu system 46
To manually focus the Main Camera 32
To select a preset 34
To store the current camera position 34
To use the dataport for PC applications 103
Tracker 99
Trademarks 3

U

Unpacking 13
Using a SUB-address 72
Utilities 51

V

VCR - Playback 100
VCR - Recording 100
VGA Out 67
VGA Resolutions 47
VGA Settings 67
Video
 input 65
 inputs 32, 95
 mode 48
 outputs 95
 sources 32
Video call 22
Video cassette recorder (VCR) 100

Video In Name 66
View
 current settings 93
 outgoing video 30
Viewing a still image 36
VNC 65
VNC Settings 68
Voice Activated Camera Positioning 33
Voice Switched 54
Volume 30

W

Waste handling 3
WAVE Camera 10
Web Snapshots 53
Welcome menu 20
Whitebalance 66
WWW-interface 44

X

XGA 48, 67, 95, 96, 102
XGA monitor 96
XGA* 48