



KICKER

RS SERIES SYSTEM COMPONENTS

LIVIN' LOUD

OWNER'S MANUAL
R565.2, R556.2



RS-Series System Components Owner's Manual

Models: RS65.2 / RS56.2

Attention:

Please record your purchase information in the area below. We recommend attaching the original sales receipt to this manual for future reference.

If you require service on this speaker during the warranty period, you will need to provide this information and a copy of the original sales receipt to Kicker for validation of warranty repairs.

ALWAYS KEEP YOUR RECEIPT!

Congratulations!

You have purchased one of the most advanced speaker component systems in car audio. The RS-Series Component System was designed by the award-winning KICKER speaker design team, tested in the judging lanes of International Sound Competitions, and proven on the Street to deliver the ultimate in full-range frequency output, durability and outstandingly-clear SPL.

This is your "fuel for Livin' Loud™"!

Authorized Kicker Dealer: _____

Purchase Date: _____

Speaker Model Number: _____

- **CIMP™ (Curvilinear Injection-Molded Polypropylene Woofer Cones)** is a high performance composite, which remains rigid, minimizes cone flex and lowers harmonic distortion. The CIMP™ consists of a one-piece, injection-molded polypropylene material that moves as a piston, exhibiting power and control.
- **New Enhanced BAM (Basket and Motor) Assembly** utilizes a high-dampening strength cast aluminum basket, features a low-profile open design, and provides a solid foundation for the precision-aligned motor assembly.
- **Optimized Composite Rubber Surround Radius** allows extended cone excursion for additional bass output and higher SPL. Composite rubber surround offers enhanced acoustical dampening and UV protection, and gives the RS-Series System Components cone maximum EXmax™ (effective excursion) potential.
- **Flexible Mounting** of the RS56.2, which includes an 6" x 8" (15.2 cm x 20.3 cm) mounting adapter, and the RS65.2 and RS56.2, which have coaxial mounts for the tweeters, enable the RS-Series System Components to accommodate most installations.
- **Newly Designed Passive Crossover Network** allows a seamless transition between the midrange and tweeter drivers. The Zobel circuitry keeps the tweeters' impedance linear and the mylar by-pass capacitors extend the frequency response.
- **Spring-Loaded Nickel Plated Terminals** flawlessly connect medium to heavy gauge speaker wire to the sleeved high-power tinsel lead wires.
- **Teteron™ Elliptical Dome Tweeter with Neodymium Magnet** provides a smooth high frequency response with quick, detailed and spatially-correct imaging. The elliptical dome shape optimizes both off-axis (door panel mount) and on-axis response. It has a wide dispersion with increased efficiency.
- **High-Temp Polyimide Film Voice Coil Former** improves sonic and conductive properties, and prevents thermal-electrical meltdown.
- **Ferro-Fluid™** cooled tweeter voice-coil extends the high frequency transducer's life span.
- **Kicker Marine Ready** models come with water resistant mounting hardware. This enables the RS56.2 to replace stock boat speakers without rusting your ship.

PERFORMANCE

Model:	RS56.2	RS65.2
Speaker Design	2 - Way	2 - Way
Rated Impedance, ohm	4	4
DC Resistance, ohm	3	3
Sensitivity [SPLo], dB @ 1W, 1m	87	87
Power Range, Watts RMS	6-90	6-100
Peak Power Handling, Watts	180	200
Effective Frequency Range, Hz	50-21k	40-21k
Top-Mount Depth, in (cm)	2 9/16 (6.5)	2 3/4 (7.0)
Bottom-Mount Depth, in (cm)	2 13/16 (7.1)	3 (7.62)
Mounting Hole Diameter, in (cm)	5 (12.7)	5 7/16 (13.8)
Woofer Size, in (cm)	5 1/4 (13.3)	6 (15.2)
Woofer Cone Material	Polypropylene	Polypropylene
Woofer Basket Material	Cast Aluminum	Cast Aluminum
Woofer Surround Material	Composite Rubber	Composite Rubber
Tweeter Size, in (cm)	1 (2.54)	1 (2.54)
Tweeter Design	Elliptical Dome	Elliptical Dome
Tweeter Diaphragm Material	Teteron	Teteron
Tweeter Magnet Material	Neodymium	Neodymium
Outboard Crossover	Yes	Yes
Speaker Wire	Included	Included
High Pass, dB, at Frequency, Hz	18, 3500	18, 3500
Low Pass, dB, at Frequency, Hz	12, 3500	12, 3500
Grills Included	Yes	Yes

Your Kicker RS-Series System Component drivers are specifically designed for mounting in free-air applications. The speakers do not require a sealed enclosure for optimum performance. It is important to isolate the sound coming off the front of the driver from the sound radiating from the back of the driver. This isolation is usually accomplished by using the correct size driver in a factory speaker location.

Mounting

Use caution when mounting speakers through the rear deck or package tray of a vehicle. Please be aware of wiring harnesses, trunk springs, hinges, and folding seat mechanisms that may interfere with the operation of the car or speaker system. When running the speaker wires, be careful not to damage them with seat bolts or door screws.

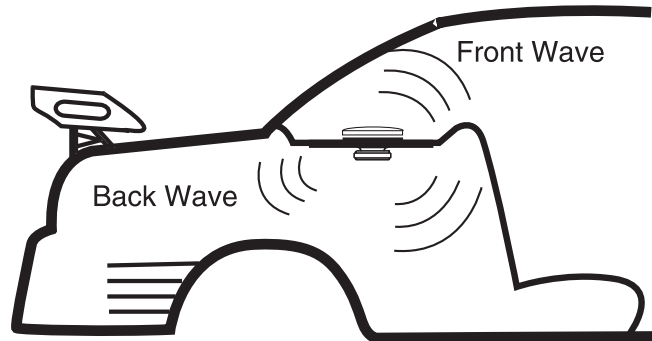

Note: To get the best performance from your Kicker RS-Series System Components, we recommend using *genuine* Kicker Accessories and Wiring.

INSTALLATION

If custom door mounting locations for the RS-Series System Components are desired, be careful to avoid interference from the window and door lock mechanisms. The first step is to find a location on the door panel that will accept the dimensions of the speaker. Then remove the door panel from the door, and check for operational clearance of the window. Cycle the window all the way down and up. If metal must be cut to mount the speakers, avoid structural metal and braces. An optional reinforcing panel (thin piece of wood or Medium Density Fiberboard) may be necessary if the door panel cannot support the weight of the speaker. Mount the speaker to the door panel and door body as outlined in Figure 1.

If the factory door speaker wiring is not available, it will be necessary to run the supplied wire through the door jamb. The speaker wire should be kept away from sharp edges and avoid the possibility of getting pinched by the door. An existing grommet in the door jamb is the ideal place to run the speaker wire. If the factory hole and grommet do not exist or are inaccessible, you must drill a hole to run the speaker wire through the door jamb. Be careful not to drill into other wiring or existing door mechanisms. Any time a wire is run through a hole, it is necessary to insert a rubber or plastic grommet to protect the wire from damage as outlined in Figure 2.

Figure 1

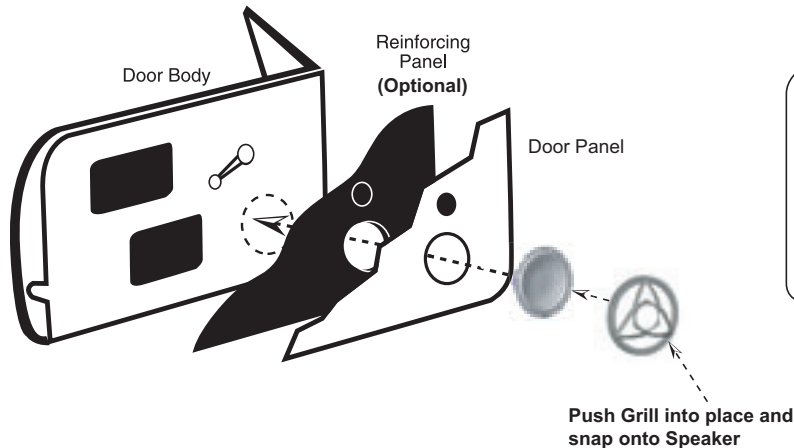
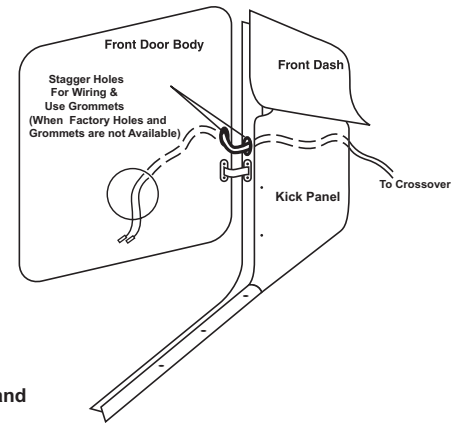

Figure 2



Tweeter Mounting

The tweeter can be mounted one of four ways: flush, surface, angled and coaxial mounting. For flush mounting applications, please refer to the illustration in Figure 3. Mount the tweeter as high up on the door and as far forward as possible without interference from the dashboard. Choose a flat location on the door with space behind the panel to allow room for the mounting nut.

After checking the clearances, cut a 2" (5.1 cm) hole in the door panel. Place the mounting nut behind the door panel. Feed the wire through the door and body panels. Mount the tweeter by screwing the tweeter onto the mounting nut.

For surface mounting applications, remove the tweeter face plate by screwing it off and install the supplied smaller face plate. Use the surface mount cup as a template and drill a 7/64" (2.8 mm) hole in the center for attaching the cup to the door and a 5/16" (7.9 mm) hole for the wires. A #8 flathead sheet metal screw is supplied to attach the surface mount cup to the door panel. Position the tweeter over the surface mount cup and press it into position.

Figure 3 (Flush Mount)

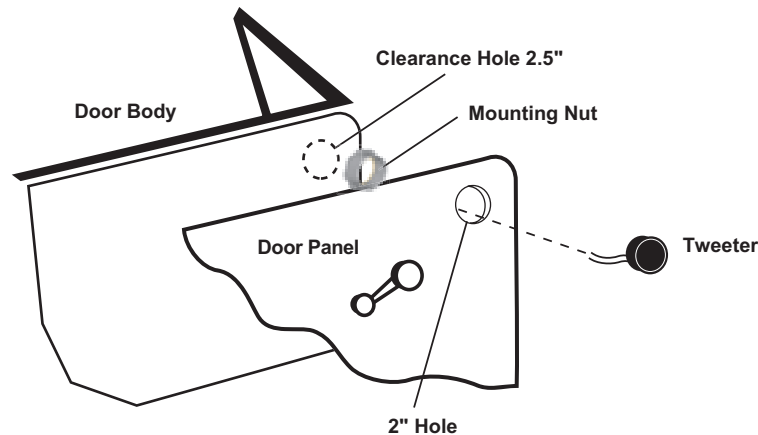

INSTALLATION

Tweeter Mounting continued

The tweeter can be mounted in the center of the midrange. This creates a high quality coaxial speaker. Remove the tweeter face plate by screwing it off and install the supplied smaller face plate. Remove the magnet boot from the midrange.

Then install the tweeter back plate by securing the supplied phillips-head machine screw to the plate, as outlined in Step 1, in Figure 4. Unscrew the bullet shaped phase plug from the center of the midrange, Step 2. Feed the wires through the included pole mount, Step 3. Then, screw the assembly into the middle of the midrange, Step 4. Run the wire through the clip on the side of the basket and mount the speaker in the desired location, Step 5.

Please use caution to run the wire through the channel on the back plate before clipping the wire on the basket and placing the magnet boot back on the midrange, this prevents damage to the speaker wire in shallow mounting depth installations.

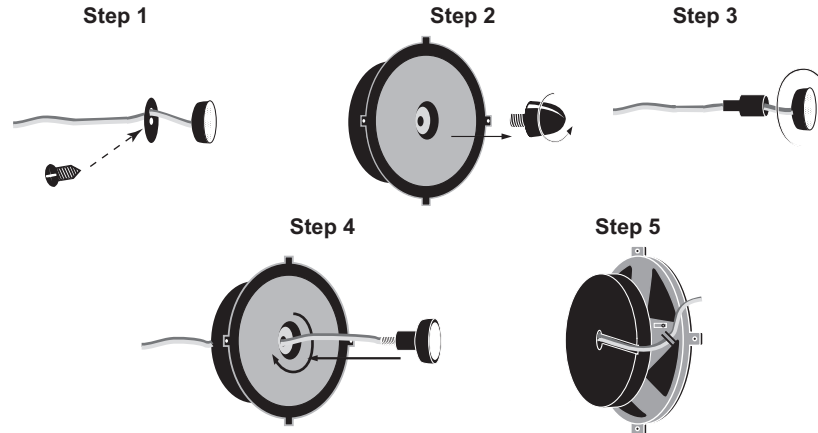
Figure 4

WIRING OPTIONS

There are three sets of wires supplied with the Kicker RS-Series System Components. One set is designed to plug on to the terminal of the midrange. The other end of this wire goes to the midrange output on the supplied crossover.

The other two sets of wires do not have any connectors on either end. One set goes from the tweeter output of the crossover to the short wire coming out of the tweeter; join these wire with the supplied butt connectors. The last set of wires are used to join the inputs of the crossover to the outputs of your source unit or amplifier. Please see Figure 5.

If you have any questions about the installation of your Kicker RS-Series System Component Speakers, see the Authorized Kicker Dealer where you made your purchase. For more advice on installation, click on the [SUPPORT](#) tab on the Kicker homepage, www.kicker.com. Choose the [Technical Support](#) tab, choose subject you are interested in, and then download or view the corresponding information. Please E-mail support@kicker.com or call Technical Services (405) 624-8583 for specific or unanswered questions.

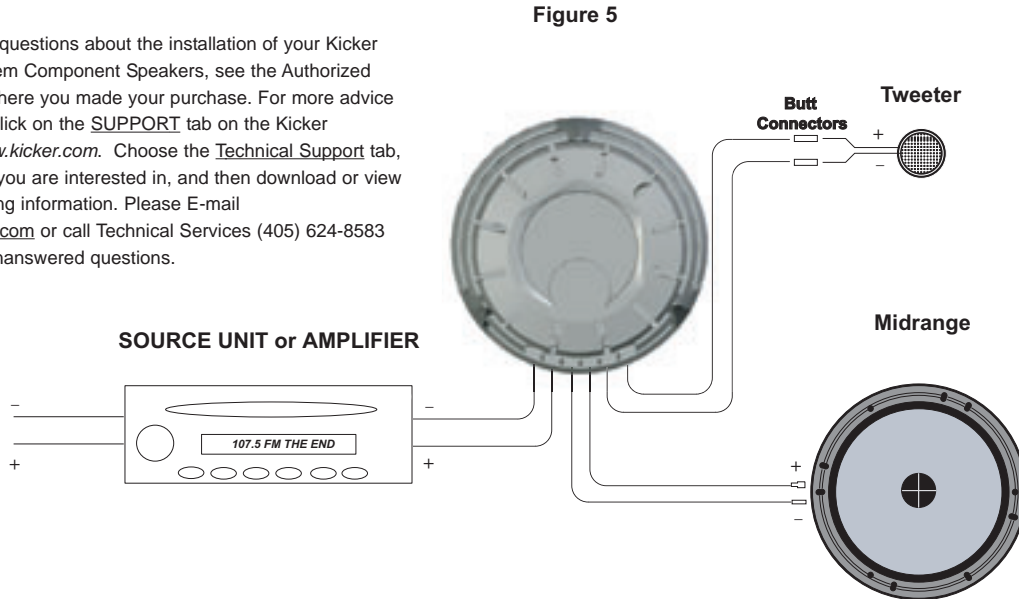

WIRING OPTIONS

Wiring two RS-Series System Components to a single channel

Modern high performance system components have a lower DC Resistance than what used to be available. The Kicker RS-Series System Components are rated at four ohms and work with any source unit or amplifier designed to operate at a four ohm load. If you want to use two RS-Series System Components on each channel of your source unit or amplifier wire the system components in series--at the connection between the crossover and source unit or amplifier, as shown below in Figure 6. This will improve the sound quality, lower the total harmonic distortion and lessen the thermal load at the source unit or amplifier. This may prevent an amplifier from shutting down, due to over-current protection circuitry.

Figure 6

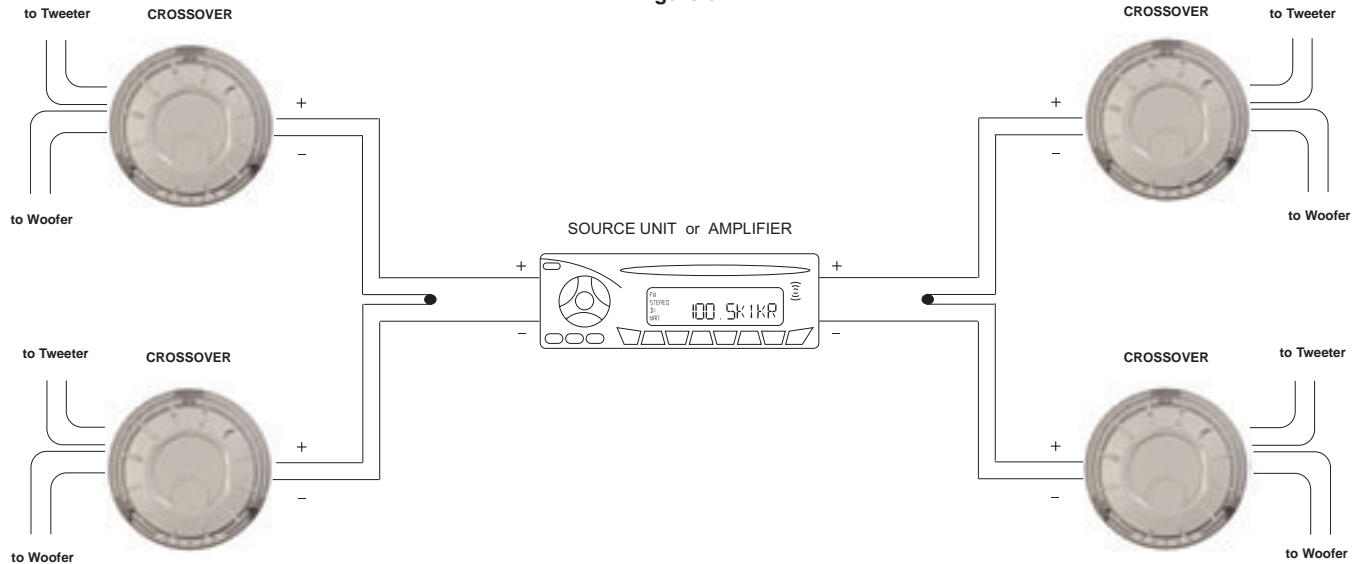

All specifications and performance figures are subject to change. Please visit kicker.com for the most current information.

ACOUSTICS LIMITED WARRANTY

Kicker warrants this product to be free from defects in material and workmanship under normal use for a period of **THREE (3) MONTHS** from date of original purchase with receipt. When purchased from an Authorized KICKER Dealer it is warranted for **ONE (1) YEAR** from date of original purchase with receipt. In all cases you **must have the original receipt!** Should service be necessary under this warranty for any reason due to manufacturing defect or malfunction during the warranty period, Kicker will repair or replace (at its discretion) the defective merchandise with equivalent merchandise at no charge. Warranty replacements may have cosmetic scratches and blemishes. Discontinued products may be replaced with more current equivalent products.

This warranty is valid only for the **ORIGINAL PURCHASER** and is not extended to owners of the product subsequent to the original purchaser. Any applicable implied warranties are limited in duration to a period of the express warranty as provided herein beginning with the date of the original purchase at retail, and no warranties, whether express or implied, shall apply to this product thereafter. Some states do not allow limitations on implied warranties, therefore these exclusions may not apply to you. This warranty gives you specific legal rights; however you may have other rights that vary from state to state..

WHAT TO DO IF YOU NEED WARRANTY OR SERVICE

Defective merchandise should be returned to your local Authorized Stillwater Designs (Kicker) Dealer for warranty. Assistance in locating an Authorized Dealer can be obtained by writing, calling, or by visiting kicker.com. You can confirm that dealer is authorized by asking to see a current authorized dealer window decal.

If it becomes necessary for you to return defective merchandise directly to Stillwater Designs (Kicker), call the Kicker Customer Service Department at (405) 624-8510 for a Return Authorization (RMA) number. Package all defective items in the original container or in a package that will prevent shipping damage, and return to:

Stillwater Designs, 5021 North Perkins Road, Stillwater, OK 74075

The RMA number must be clearly marked on the outside of the package. Please return **only defective components** (tweeter, crossover, plug, etc.). The return of functioning items increases your return freight charges. Non-defective items received will be returned freight collect.

Include a copy of the original receipt with the purchase date clearly visible, and a **"proof-of-purchase"** statement listing the Customer's name, Dealer's name and invoice number, and product purchased. Warranty expiration on items without proof-of-purchase will be determined from type of sale and the manufacturing date code. Freight must be prepaid; items sent freight collect, or COD, will be refused.

Failure to follow these steps may void your warranty. Any questions can be directed to the Kicker Customer Service Department at (405) 624-8510.

WHAT IS NOT COVERED?

This warranty is valid only if the product is used for the purpose for which it was designed.

It does not cover:

- Damage due to improper installation.
- Subsequent damage to other components.
- Damage caused by exposure to moisture, excessive heat, chemical cleaners, and/or UV radiation.
- Damage through negligence, misuse, accident or abuse. Repeated returns for the same damage may be considered abuse.
- Any cost or expense related to the removal or reinstallation of product.
- Speakers damaged due to amplifier clipping or distortion.
- Items previously repaired or modified by any unauthorized repair facility.
- Return shipping on non-defective items.
- Products with tampered or missing bar code labels.
- Products returned without a Return Authorization (RMA) number.
- Freight Damage.
- The cost of shipping product to Kicker.
- Service performed by anyone other than Kicker.

HOW LONG WILL IT TAKE?

Kicker strives to maintain a goal of 24-hour service for all acoustics (subwoofers, midrange drivers, tweeters, crossovers, etc) returns. Delays may be incurred if lack of replacement inventory or parts is encountered.

INTERNATIONAL WARRANTY

Contact your International Kicker dealer or distributor concerning specific procedures for your country's warranty and service policies.



STILLWATER
Designs®

P.O. Box 459 • Stillwater, Oklahoma 74076 • U.S.A. • (405) 624-8510

WARNING:

KICKER drivers are capable of producing sound levels that can permanently damage your hearing! Turning up a system to a level that has audible distortion is more damaging to your ears than listening to an undistorted system at the same volume level. The threshold of pain is always an indicator that the sound level is too loud and may permanently damage your hearing.

Please use common sense when controlling volume!

