



ADMINISTRATION GUIDE

Cisco Small Business

PVC2300 and WVC2300 Internet Video Cameras with
Audio

CCDE, CCENT, CCSI, Cisco Eos, Cisco HealthPresence, Cisco Ironport, the Cisco logo, Cisco Lumin, Cisco Nexus, Cisco Nurse Connect, Cisco Stackpower, Cisco StadiumVision, Cisco TelePresence, Cisco Unified Computing System, Cisco WebEx, DCE, Flip Channels, Flip for Good, Flip Mino, Flip Video, Flip Video (Design), Flipshare (Design), Flip Ultra, and Welcome to the Human Network are trademarks; Changing the Way We Work, Live, Play, and Learn, Cisco Store, and Flip Gift Card are service marks; and Access Registrar, Aironet, AsyncOS, Bringing the Meeting To You, Catalyst, CCDA, CCDP, CCIE, CCIP, CCNA, CCNP, CCSP, CCVP, Cisco, the Cisco Certified Internetwork Expert logo, Cisco IOS, Cisco Press, Cisco Systems, Cisco Systems Capital, the Cisco Systems logo, Cisco Unity, Collaboration Without Limitation, EtherFast, EtherSwitch, Event Center, Fast Step, Follow Me Browsing, FormShare, GigaDrive, HomeLink, Internet Quotient, IOS, iPhone, iQuick Study, IronPort, the IronPort logo, LightStream, Linksys, MediaTone, MeetingPlace, MeetingPlace Chime Sound, MGX, Networkers, Networking Academy, Network Registrar, PCNow, PIX, PowerPanels, ProConnect, ScriptShare, SenderBase, SMARTnet, Spectrum Expert, StackWise, The Fastest Way to Increase Your Internet Quotient, TransPath, WebEx, and the WebEx logo are registered trademarks of Cisco Systems, Inc. and/or its affiliates in the United States and certain other countries.

All other trademarks mentioned in this document or website are the property of their respective owners. The use of the word partner does not imply a partnership relationship between Cisco and any other company. (0907R)

Chapter 1: Introduction	1
Minimum Requirements	2
Camera Lens Specifications	3
Chapter 2: Planning Your Wireless Network	5
Wireless Network Layout	5
Additional Security Tips	6
Security Threats Facing Wireless Networks	6
Chapter 3: Getting to Know the PVC2300 and WVC2300 Cameras	9
Front Panel	9
Ready LED (Amber)	10
Network LED (Green)	10
Lens	10
Built-in Microphone	10
Back Panel	11
Antenna Connectors	11
Reset	12
Ethernet	12
Activity LED	13
PVC2300 PoE LED	13
Power	14
GPIO	14
Mic In	14
Spkr Out	14
Side Panel	14
Chapter 4: Connecting the Camera	15
Cisco Wired Network	16
Cisco Wireless Network	17
Camera Installation Guidelines	18

Camera Hardware Installation	18
Adjusting The Lens	22
Audio Options	23
Chapter 5: Installing the Camera Software	24
Configuring the Basic Camera and Network Settings	24
Setting Up the Wireless Connection on the WVC2300 Camera	28
Wired and Wireless Modes	32
Moving the Camera to Another Network	32
Chapter 6: Upgrading the Camera Firmware	34
Chapter 7: Using the Web-Based Configuration Utility	36
Launching the Web-Based Configuration Utility	36
Home	37
Refresh	38
Setup	38
Connected User	38
Log Out	38
About	38
Help	38
Video Options Icons	39
Setup	41
Chapter 8: Configuring the PVC2300 and WVC2300 Cameras	42
Accessing the Setup Options	43
Setup > Basic Setup	44
Device Settings	44
Network Settings	45
Wireless Settings	46
Setup > Advance Setup	49

HTTP/HTTPS	49
RTP/RTSP	49
UPnP	50
Bonjour	51
QoS	51
CoS	51
Setup > IP Filter	52
IP Filter Settings	52
Administration > Users	53
Administrator	53
Demo	53
User List	53
Administration > Maintenance	54
Restore Factory Defaults	54
Restart	54
Configuration	54
Administration > Firmware	55
Firmware Upgrade	55
Audio/Video > Video	56
MPEG-4 Settings	56
MJPEG Settings	56
Mobile Settings	57
Video Adjustments	57
Options	58
Day/Night Switch	59
Audio/Video > Audio	60
Audio Settings	60
Applications > Mail	62
Primary SMTP Server	62
Secondary SMTP	63
E-mail Setup	64

E-mail Body	64
Applications > FTP	65
Primary FTP	65
Secondary FTP	65
Applications > Instant Messaging	67
Jabber	67
Applications > Motion Detection	68
Applications > Event	70
Event Schedule	70
New Schedule	70
Trigger Event	71
Event Attachment	72
Applications > DDNS	74
DDNS	74
Applications > I/O Ports	75
Input Ports	75
Output Ports State at Power On	75
Output Ports Manual Control	76
Applications > RS-485	77
Port Settings	77
Preset Position	77
Patrol Sequence	78
Applications > SMB/CIFS	81
Status > System	82
Status > Image	82
MPEG-4	82
MJPEG	82
Status > Network	83
Network	83
Wireless	83
Status > Syslog & Log	84

Log Type	84
Syslog Server	84
Log List	84
Status > Video Log	85
Video Log	85

Chapter 9: Sample Configurations 86

Configuring Instant Recording	86
Defining Preset Positions for Patrol Sequence	87
Using Patrol Sequence	88
Configuring E-Mail Alerts	89
Scheduling an Event	91
Configuring Motion Detection Area and Sensitivity	92
Configuring Port Forwarding	94
Setting Security Precautions on the Cisco WVC2300	97

Appendix A: Troubleshooting 98

Questions and Answers	98
Windows Help	101
TCP/IP	101
Shared Resources	101
Network Neighborhood/My Network Places	101

Appendix B: WVC2300 Camera Bandwidth Test 102

Appendix C: Specifications 104

PVC2300 Specifications	104
WVC2300 Specifications	108
I/O Port Specifications	111

Appendix D: Where to Go From Here 114

Introduction

Thank you for choosing the Cisco Small Business Internet Video Camera with Audio. This administration guide covers two models.

- PVC2300 Business Internet Video Camera with Audio and PoE (Power over Ethernet)
- WVC2300 Wireless-G Business Internet Video Camera with Audio

For the purpose of this administration guide, whenever a feature applies to both models, the word camera(s) will be referenced. If a specific model number is mentioned, then the feature is specific to that model

The Cisco camera surveillance solutions are high quality solutions which can be optimized for many different applications. The box-type form factor allows these cameras to be used as-is or put inside an outdoor enclosure for interior or exterior applications. The cameras use removable CS-mount lenses and can be customized with Zoom, Wide-Angled, Vari-focal, Auto-Iris (DC type), or other type of lenses as required for the specific application.

The PVC2300 provides Power over Ethernet (PoE) functionality that facilitates installation of the PVC2300 in places out of reach of a power outlet.

The cameras can be remotely controlled through an RS-485 interface and mounted on any PT (pan/tilt) base that supports Pelco-D protocol. The camera supports 2 input and 2 output connectors which can be used for connecting to an alarm panel, siren, PIR, smoke detectors, light switch (on/off), door opener, etc.

The cameras incorporate a high quality progressive scan CCD sensor, delivering good quality undistorted video. The sensor used in the cameras has low light sensitivity capability. This means that video can be viewed when very low light (near darkness) is present. Additionally, the cameras incorporate an IR Cut Filter switcher which, when used with a separate IR lamp, allows for viewing of video in total darkness.

The cameras support dual CODECs—MPEG-4 and MJPEG. Both CODECs can be used simultaneously. MPEG-4 gives efficient bandwidth consumption with good quality compression and is optimal for real-time viewing of video. MJPEG gives optimal video quality in lossy environments making it ideal for video storage to a NAS device. Lossy compression is very effective in reducing digital file sizes, resulting in smaller video file sizes with minor data loss.

The camera's audio capabilities include 2-way audio, an embedded microphone, external speaker and microphone ports, and voice compression.

With extensive feature support such as IP Multicast, RTSP, RTP, and 3GPP, video can be viewed from multiple endpoints and client applications like 3G phones and Quicktime clients on PCs or Wi-Fi phones.

Support for multiple network protocols like 802.1p priority, 802.1q VLANs, and Dynamic DNS, make the solution ideal for multiple IP surveillance applications. The cameras can also be managed securely using HTTPS.

**NOTE**

Before installing a surveillance system, check with local government agencies to determine if video surveillance and audio monitoring are permitted in your area.

Minimum Requirements

The following tables list the minimum requirements for your PC when monitoring one camera or up to eight cameras.

Minimum System Requirements (for one camera):	
CPU	Pentium 4 class, 2 GHz
Memory	512 MB
Operating System	Microsoft Windows 2000, XP or Vista
Hard Drive	500 MB of available space
Graphics Card	AGP with a minimum 128 MB
Browser	Internet Explorer 6.0 (or later) or Mozilla Firefox

Minimum System Requirements (for up to eight cameras):	
CPU	Pentium 4 class, 3 GHz dual-core
Memory	1 GB
Operating System	Microsoft Windows 2000, XP or Vista
Hard Drive	4 GB of available space
Graphics Card	NVidia high performance or equivalent with a minimum 256 MB
Browser	Internet Explorer 6.0 (or later) or Mozilla Firefox

**NOTE**

More than eight cameras can be monitored if you reduce the resolution and frame rate settings for the video captures. The resolution and video quality can be adjusted from the Audio/Video > Video window in the web-based utility. See [“Audio/Video > Video” section on page 56.](#)

Camera Lens Specifications

The following lens can be used with the PVC2300 and WVC2300 IP cameras:

Model Number	Camera Lens	Mount	Further Information
CIVS-IPC-VT38	Tamron 3-8 mm Varifocal Lens	CS	Go to www.cisco.com/go/surveillance for accessory data sheets and more information.
CIVS-IPC-VT31	Tamron 3-11 mm Varifocal Lens		
CIVS-IPC-VT55	Tamron 5-50 mm Varifocal Lens		
CIVS-IPC-VF38	Fujinon 3-8 mm Varifocal Lens		
CIVS-IPC-VF31	Fujinon 3-11 mm Varifocal Lens		
CIVS-IPC-VF55	Fujinon 5-50 mm Varifocal Lens		
CAMLMI	Tamron 1/3-inch 3~8 mm Varifocal 2.7X Zoom Lens		
CAMLWA	Computar 1/3-inch 2.3 mm Wide Angle Lens		

For more information about camera accessories, see the Cisco Small Business Camera Accessories Installation and Administration Guide.

Planning Your Wireless Network

A wireless local area network (WLAN) is exactly like a regular local area network (LAN), except that each computer in the WLAN uses a wireless device to connect to the network. Computers and other devices, such as peripherals, in a WLAN share the same frequency channel and SSID, which is an identification name for wireless devices. This chapter includes the following sections:

- [Wireless Network Layout, page 5](#)
- [Additional Security Tips, page 6](#)
- [Security Threats Facing Wireless Networks, page 6](#)

Wireless Network Layout

The WVC2300 camera is compatible with 802.11g routers, such as model number WRVS4400N, as well as 802.11g access points, including model number WAP4410N. The camera can also communicate with network adapters, such as the Wireless-G Notebook Adapter (model number WPC4400N) for your laptop computers, Wireless-G PCI Adapter (model numbers WMP200) for your desktop PCs, and Wireless-G USB Adapter (model number WUSB200) for your computers that connect to the wireless network through USB modems.

With these, and many other Cisco products, your networking options are limitless. Go to the Cisco website at www.cisco.com for more information about Cisco products.



NOTE

Your wireless range is variable and depends on your environment.

Additional Security Tips

- Keep wireless routers, access points, or gateways away from exterior walls and windows.
- Turn wireless routers, access points, or gateways off when they are not being used (at night, during vacations).
- Use strong passphrases that are at least eight characters in length. Combine letters and numbers to avoid using standard words that can be found in the dictionary.

Security Threats Facing Wireless Networks

Cisco wants to make wireless networking as safe and easy for you as possible. The current generation of Cisco products provide several network security features, but they require specific action on your part for implementation. So, keep the following suggestions in mind whenever you are setting up or using your wireless network. Also, see [“Setting Security Precautions on the Cisco WVC2300” on page 97](#).

Wireless networks are easy to find. Hackers know that in order to join a wireless network, wireless networking products first listen for “beacon messages.” These messages can be easily decrypted and contain much of the network’s information, such as the network’s SSID (Service Set Identifier). Here are the steps you can take to prevent intruders:

Change the administrator’s password regularly. With every wireless networking device you use, keep in mind that network settings (SSID, WEP keys, etc.) are stored in its firmware. Your network administrator is the only person who can change network settings. If a hacker learns the administrator’s password, he, too, can change those settings. So, make it harder for a hacker to get that information. Change the administrator’s password regularly.

SSID. There are several things to keep in mind about the SSID:

- Do not broadcast it
- Make it unique
- Change it often

Most wireless networking devices will give you the option of broadcasting the SSID. While this option may be more convenient, it allows anyone to log into your wireless network. This includes hackers. So, don't broadcast the SSID.

Wireless networking products come with a default SSID set from the factory. (The Cisco default SSID is "ciscosb".) Hackers know these defaults and can check these against your network. Change your SSID to something unique and not something related to your company or the networking products you use.

Change your SSID regularly so that any hackers who have gained access to your wireless network will have to start from the beginning in trying to break in.

MAC Addresses. Enable MAC Address filtering. MAC Address filtering allows you to provide access to only those wireless nodes with certain MAC Addresses. This makes it harder for a hacker to access your network with a random MAC Address.

WEP Encryption. Wired Equivalent Privacy (WEP) is often looked upon as a cure-all for wireless security concerns. This is overstating WEP's ability. Again, this can only provide enough security to make a hacker's job more difficult. There are several ways that WEP can be maximized:

- Use the highest level of encryption possible
- Use "Shared Key" authentication
- Change your WEP key regularly

WPA/WPA2 Personal. WPA stands for Wi-Fi Protected Access, which is a security standard stronger than WEP encryption. A network encrypted with WPA/WPA2 is more secure than a network encrypted with WEP, because WPA/WPA2 uses dynamic key encryption. To protect the information as it passes over the airwaves, you should enable the highest level.

WPA/WPA Enterprise. Enterprise refers to using RADIUS server for authentication, while RADIUS stands for Remote Authentication Dial-In User Service. This type of authentication requires some advanced expertise because it involves setting up a RADIUS server for authentication and, in some cases, creation of certificates for both the RADIUS server and the camera.

If you are using WPA/WPA2 Enterprise security, you will need to upload security certificates to the camera. Certificates must be in the following format:

- Root certificate: DER encoded binary x.509 (CER/PEM)
- User certificate: Personal Information Exchange (PKCS# 12(.PFX))

Implementing encryption may have a negative impact on your network's performance, but if you are transmitting sensitive data over your network, encryption should be used.

These security recommendations should help keep your mind at ease while you are enjoying the most flexible and convenient technology Cisco has to offer.



CAUTION

Always remember that each device in your wireless network **MUST** use the same encryption method and encryption key or your wireless network will not function properly.

Getting to Know the PVC2300 and WVC2300 Cameras

This chapter describes the external features of the Cisco PVC2300 and WVC2300 Internet Video Cameras and includes the following sections:

- [Front Panel, page 9](#)
- [Back Panel, page 11](#)
- [Side Panel, page 14](#)

Front Panel

The LEDs, camera lens, and built-in microphone are located on the front panel of the camera.



Ready LED (Amber)

The Ready LED has the following states:

- **Off**—Camera is powered off.
- **On**—Camera is powered on.
- **Flashing**—The Ready LED will flash during start up. This will take 15 to 20 seconds.

Network LED (Green)

The Network LED has the following states:

- **Off**—Network connection not detected.
- **On**—Network connection detected.
- **Flashing**—Sending/receiving data.

Lens

The camera includes a removable CS-mount lens.

- For specifications on the included lens, refer to [Appendix C, "Specifications."](#)
- For a list of recommended lenses to use with this camera, see ["Camera Lens Specifications" on page 3](#). Also, refer to the Cisco Small Business Camera Accessories Installation and Administration Guide.

Built-in Microphone

There is a built-in microphone mounted on the front of the camera. The camera also has a connection for an external microphone on the rear. Connecting an external microphone will disable the built-in microphone.

Back Panel

The ports and reset button are located on the back panel of the camera. The following shows the back panel of the PVC2300.



The following shows the back panel of the WVC2300.



Antenna Connectors

Antenna connectors are only found on the WVC2300 camera. The connectors are used to attach the antennas to the device for wireless connectivity.

Reset

The reset button can be accessed with a straightened paper clip or similar object. The reset button has two functions:

- **Restore Factory Defaults**—To restore the factory default settings, press the **Reset** button for more than 10 seconds. When you let go of the button, the LEDs on the front of the camera will flash and then return to a normal state when the camera is ready.
- **Set Static IP Address**—By default the camera is set to receive an IP address from a DHCP server. If you do not have a DHCP server on your network, you can set a static IP address by pressing the **Reset** button on the camera for less than 10 seconds. A default IP address of **192.168.1.99** will be assigned to the camera. This information also can be set in the Setup Wizard and in the web-based configuration utility for the camera.

Tips when using the default IP address:

- If the camera is connected directly to your computer, then your computer needs to be on the same subnet as the default IP address in order to access the configuration utility.
- If you are using a router, you may be on a different subnet such as 192.168.2.1.

Ethernet

The Ethernet port supports network speeds of either 10 Mbps or 100 Mbps, and can operate in half and full-duplex mode.

Auto-sensing technology enables the port to automatically detect the speed of the device connected to it (10 Mbps or 100 Mbps), and adjust its speed and duplex accordingly.

The Ethernet port supports automatic MDI/MDI-X operation, so you can use straight-through or crossover cables to connect to PCs, servers, or switches.



NOTE

NOTE FOR PVC2300: The PVC2300 camera's Ethernet port also supports the IEEE 802.3af Power-over-Ethernet (PoE) standard that enables DC power to be supplied to the camera using wires in the connecting twisted-pair cable. Any 802.3af-compliant device attached to the port can directly supply power to the camera

over the twisted-pair cable without requiring its own separate power source. This capability gives network administrators centralized power control, which translates into greater network availability.

To connect a device to the port, you will need to use Category 5 (or better) network cable.

**NOTE**

NOTE FOR WVC2300: Attaching an Ethernet cable will disable the wireless interface on the WVC2300 camera. Only one interface can be active at any time.

**NOTE**

NOTE FOR WVC2300: On the WVC2300 camera, the Ethernet cable should only be connected or disconnected when the camera is powered OFF. Attaching or detaching the Ethernet cable while the camera is powered on does NOT switch the interface between wired and wireless. In order to switch from wired to wireless or vice versa, the power needs to be disconnected and reconnected to change from one mode to the other. Disconnecting the Ethernet while power is on will merely disconnect the camera from the network.

Activity LED

The Activity LED flashes when activity is detected on the Ethernet port.

PVC2300 PoE LED

This LED only functions on the PVC2300 camera. The LED has the following states:

- **On**—PoE connection is detected.
- **Off**—PoE connection is not detected.

On the back panel, the green LED is the PoE indicator and when on, indicates that you have PoE power. If you plug in the power supply, this LED will not light up. Another good indicator is if you happen to plug in both the PoE and regular power supply, if the green LED is on, this indicates you have PoE power and if not, it indicates you have lost power from your PoE switch.

Power

The Power port is where you will connect the power adapter.



NOTE

NOTE FOR PVC2300: The Power port is automatically turned off if a PoE connection is detected on the Ethernet port.

GPIO

This port is utilized for I/O connections. Detailed specifications can be found in the Specifications section of this Administration Guide.

Mic In

This jack is used to connect an external microphone to the camera.

Spkr Out

This jack is used to connect powered speakers to the camera.

Side Panel

The security slot is located on a side panel of the camera and can be used to attach a Kensington lock.



Connecting the Camera

This chapter will guide you through the hardware installation for the Cisco PVC2300 and WVC2300 Internet Video Cameras. There are procedures for installing the camera into a wired or wireless network. The following sections are included:

- [Cisco Wired Network, page 16](#)
- [Cisco Wireless Network, page 17](#)
- [Camera Installation Guidelines, page 18](#)
- [Camera Hardware Installation, page 18](#)
- [Adjusting The Lens, page 22](#)
- [Audio Options, page 23](#)

Cisco Wired Network

The following illustration provides an example of a Cisco wired network:

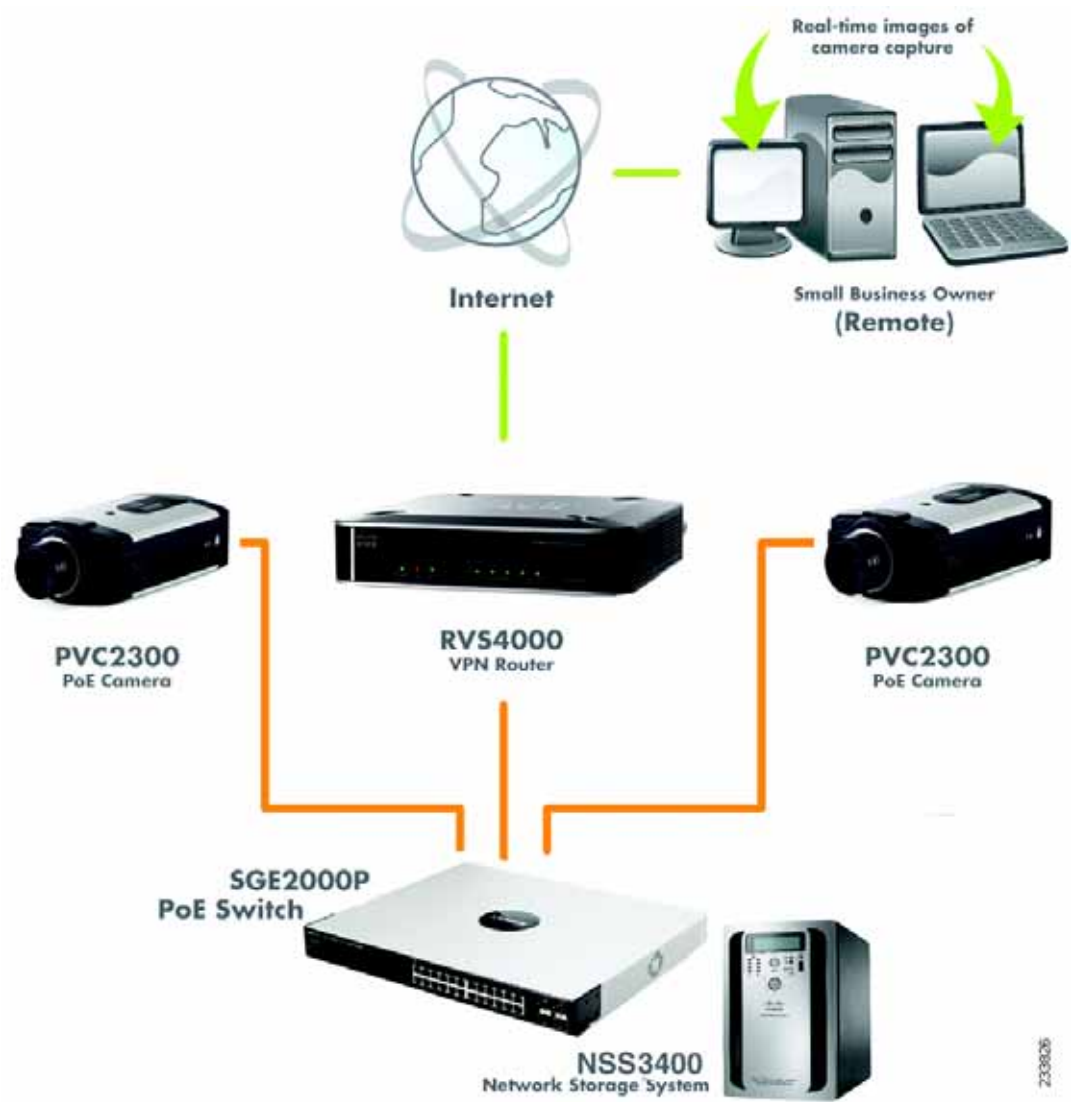

Cisco Wireless Network

The following illustration provides an example of a Cisco wireless network:

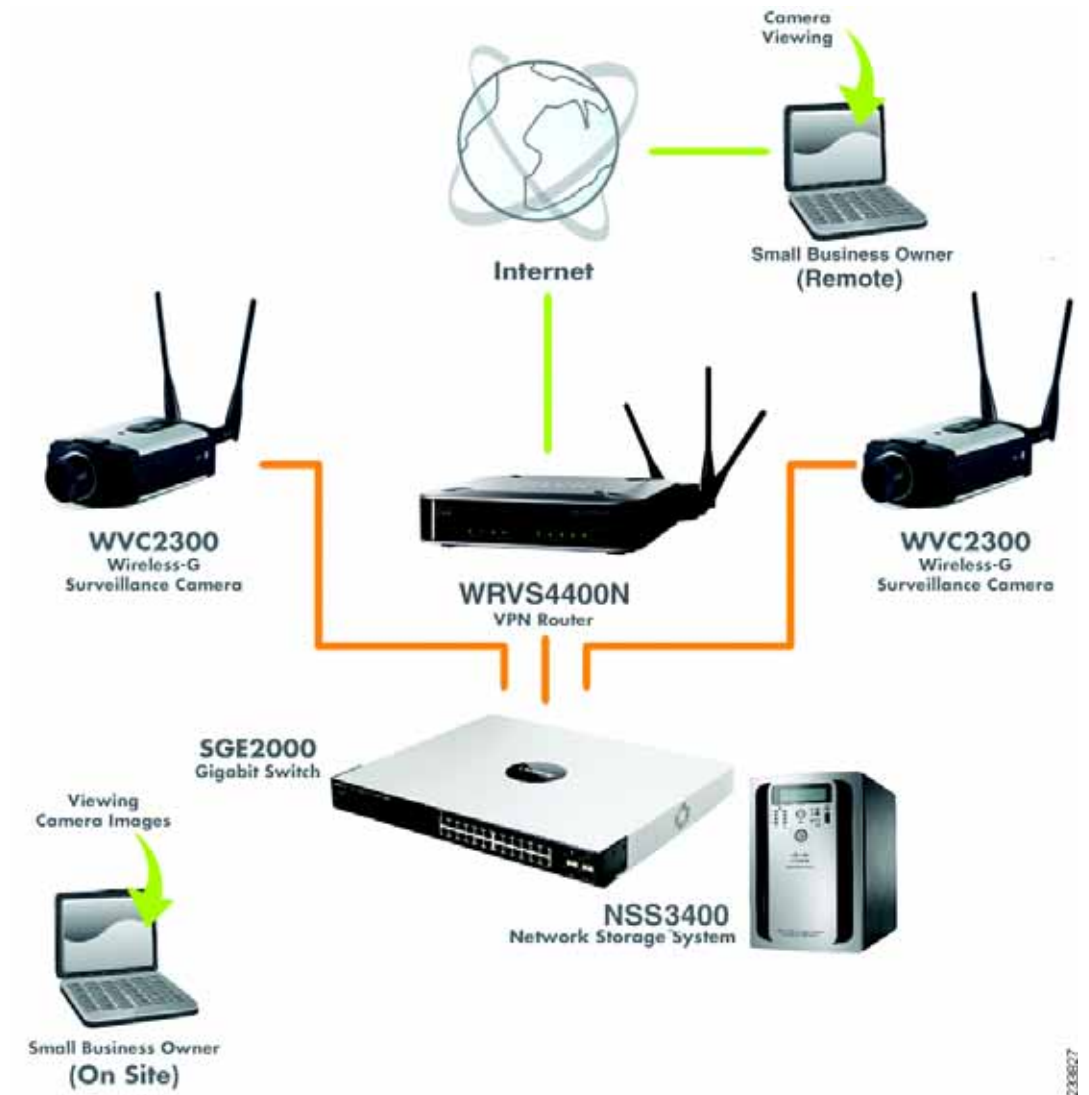

238627

Camera Installation Guidelines

Consider the following guidelines before installing and mounting your cameras. While the motion detection window and the degree of sensitivity can be optimized later, it is best to optimize your camera location first.

- Choose a location that provides adequate coverage of the area to be monitored.
- If using the microphone in the camera, note that the cameras are designed to pick up audio from a distance (unlike a web camera that you would place near you.)
- If using an external microphone or speaker, place the microphone far enough away from the speaker to avoid feedback. The volume of the speaker and the background noise of the environment will determine the exact distance, possibly up to one yard (one meter) away.
- Cameras mounted outdoors should be installed in an IP66-certified enclosure to protect the camera from the elements, while maintaining acceptable operating temperatures. If an enclosure is used, an external microphone is required for audio.
- If using motion detection, consider potential sources of false positives, such as trees and shrubs, drastic light changes, wandering animals, and traffic.

Camera Hardware Installation

Follow these steps to install the PVC2300 or WVC2300 camera:



NOTE

Before attaching the camera extension or swivel head, the stand base can be mounted in a permanent location by using three screws to secure the stand base to the desired location.

STEP 1

(Optional) Attach the base of the camera stand to a permanent location by using three screws.

STEP 2 Assemble the camera stand in one of the following ways:

- Attach the swivel head directly to the stand base.

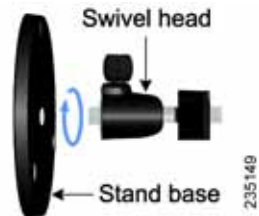

- If an extension is necessary, attach the camera extension to the stand base and then attach the swivel head to the extension.

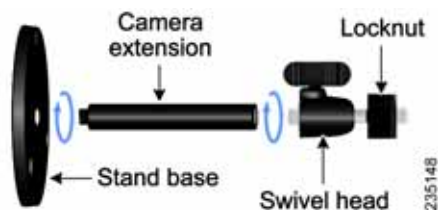

STEP 3 Connect the camera stand to the bottom of the camera.



STEP 4 Adjust the camera to the appropriate viewing position and secure the camera in place by tightening the locknut.

STEP 5 Connect the included Ethernet network cable to your network router or switch.



STEP 6 Connect the other end of the cable to the camera Ethernet port.



NOTE If your network switch provides Power over Ethernet (PoE), proceed to step 8. If you are not sure if the switch provides PoE, refer to the switch documentation.

STEP 7 If your network switch does not provide PoE, connect the included power adapter to the Power port of the camera and insert the other end into a standard electrical outlet.



STEP 8 Verify that the camera LEDs are lit.



LED	Color	Activity	Action
Ready	Amber	Off	Camera is powered off.
		On	Camera is powered on.
		Blink	Camera is booting.
Network	Green	Off	Network connection not detected.
		On	Network connection detected.
		Blink	Sending and receiving data.



NOTE If you are installing the PVC2300 camera, you are done with the camera installation. However, if you are installing the WVC2300 camera, proceed to the next step.

STEP 9 Connect each of the two antennas to the antenna connectors on the back of the camera.



STEP 10 Place the antennas in an upright position.



Congratulations! You have completed the camera hardware installation. Continue with [Chapter 5, "Installing the Camera Software."](#)

Adjusting The Lens

The PVC2300 and WVC2300 Internet Cameras use an adjustable CS mount lens. Adjust the focus by slowly rotating the camera Lens Focus clockwise or counterclockwise.



NOTE The resolution and video quality can be adjusted from the Audio/Video > Video window in the web-based utility. See ["Audio/Video > Video" section on page 56](#). Use the camera Lens Focus to fine tune the image.

Audio Options

To use your own microphone instead of the camera's built-in microphone, follow these steps:

**NOTE**

The microphone you use must have its own source of power, like your computer speakers.

STEP 1 Connect the 3.5 mm input jack of your microphone to the MIC IN port on the camera's back panel. The built-in microphone will automatically be disabled.

STEP 2 Place the external microphone in an appropriate location.

To use an optional external speaker with the camera, follow these steps:

**NOTE**

The speakers need to be "powered" speakers, like your computer speakers.

STEP 1 Connect the 3.5 mm jack of your speaker to the SPKR OUT port on the camera's back panel.

STEP 2 Place the external speaker in an appropriate location.

Installing the Camera Software

This chapter describes installing the Cisco PVC2300 and WVC2300 Internet Video Camera software and setting up the wireless connection on the WVC2300 camera. The following sections are included:

- [Configuring the Basic Camera and Network Settings, page 24](#)
- [Setting Up the Wireless Connection on the WVC2300 Camera, page 28](#)
- [Wired and Wireless Modes, page 32](#)
- [Moving the Camera to Another Network, page 32](#)

Configuring the Basic Camera and Network Settings

The Cisco PVC2300 and WVC2300 Internet Cameras can be set up using the Setup Wizard that is included on the product CD. There are two ways to use the Setup Wizard:

1. Launch the Setup Wizard from the CD. Launching from the CD is useful if you do not want to install the software on your computer.
2. Install the software on your computer. This is useful if you want to install more cameras in the future and don't want to search for the CD.



NOTE

Microsoft Internet Explorer (IE) is the supported browser for the PVC2300 and WVC2300 cameras.



NOTE

If the Setup Wizard does not find your Cisco PVC2300 or WVC2300 camera, enable Universal Plug and Play (UPnP) on you computer. See the instructions for enabling UPnP in [Appendix A, "Troubleshooting."](#)

To configure basic camera and network settings, follow these steps:

-
- STEP 1** Insert the Setup CD into your CD-ROM drive. If the CD doesn't run automatically, go to **My Computer** and click on your CD-ROM drive.
- STEP 2** The Welcome window appears. Click **Start**.
- STEP 3** The License Agreement window appears. Click **Next** if you agree.
- STEP 4** The Wizard searches your network for your camera and displays a list of all cameras found. From the Camera Discovery window, highlight the camera you want to configure and click **Next**. If the camera you want to configure is not displayed in the Selection box, enable UPnP on your computer as described in [Appendix A, "Troubleshooting"](#) and click **Search Again**.
- STEP 5** When prompted, type **admin** in both the Administrator Name and Administrator Password fields. The default user name and password is **admin**. Click **OK**.



NOTE For security purposes, it is recommended that you change the password using the camera's web-based utility at a later time. See ["Administration > Users"](#) on page 53.

- STEP 6** From the Basic Settings window, configure the following settings:
- **Camera Name**—Enter a unique name for the camera, up to 16 characters in length. Unique names are helpful when you are using multiple cameras on the same network.
 - **Description**—Enter a description, up to 32 characters in length, with additional information such as the location of the camera.
 - **Time Zone**—Select the time zone that corresponds with the camera's location.
 - **Date**—Enter the current date. This sets the camera's calendar date and the information is used when the date stamp is referenced in the image captures.
 - **Time**—Enter the current time. This sets the camera's clock and is used when the time stamp is referenced in the image captures.

You have completed identifying the camera and configuring the basic settings.

- STEP 7** Click **Next** to continue and configure the network settings.

- STEP 8** In the Network Settings window, select **Static IP address** from the drop-down list if you want to assign the IP address. Otherwise, leave the default setting as Obtain An IP Address Automatically (DHCP) and click **Next**.
- STEP 9** The current settings of the camera are displayed. Make any changes needed for your network and click **Next**.
- STEP 10** From the Review Camera Settings window, click **Next** to confirm the settings or click **Back** to make changes.
- STEP 11** From the Confirm Settings window, click **OK** to continue or **Cancel** to close the Confirm Settings window. When **Cancel** is clicked, you can click **Back** to make changes.
- When **OK** is clicked, the new settings are saved.
- STEP 12** A dialog box appears indicating that the configuration has been saved successfully. Click **OK** to continue.
- STEP 13** Congratulations! Your camera is now configured. Click **Finish** to complete the process.
- The PVC2300 or WVC2300 Internet Camera Home window launches.
- STEP 14** When prompted, enter **admin** in both the User name and Password fields on the login window. The default username and password is **admin**.

STEP 15 Internet Explorer prompts you to install ActiveX. In order to view video, you must accept the ActiveX.

After installing ActiveX, the home window displays.

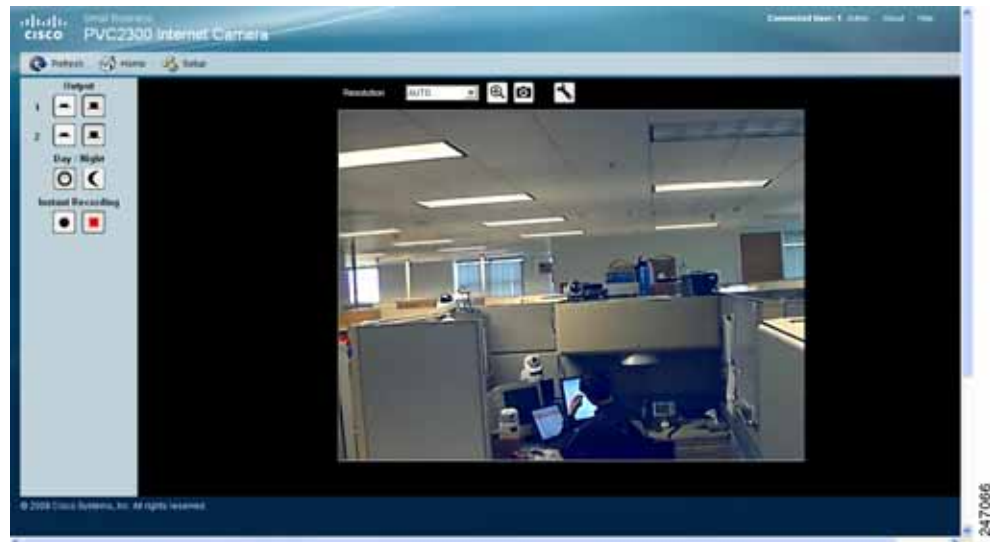

Setting Up the Wireless Connection on the WVC2300 Camera

To configure the WVC2300 camera for wireless connectivity, follow these steps:

-
- STEP 1** Click **Setup** in the toolbar to open the Setup > Basic Setup window.
- STEP 2** Enter the appropriate Wireless Settings:
- **SSID**—The SSID is the network name shared among all devices in a wireless network. Enter the network's SSID or network name here. The SSID is case sensitive. Default is ciscosb.
 - **Security**—Click **Edit Security Settings** to display the Wireless Security window.
- STEP 3** From the Wireless Security window, select the drop-down list from Security Mode to select the appropriate option based on your wireless network configuration:
- **Disabled**—No security is implemented on your wireless network. Data is not encrypted before transmission.
 - **WEP**—WEP is a basic encryption method that is not as secure as later methods such as WPA-Personal or WPA2 Personal. However, it is supported by all clients.
 - **WPA /WPA2 Personal**—Offers two encryption methods, TKIP and AES, with dynamic encryption keys.
 - **WPA /WPA2 Enterprise**—Requires that your LAN has a RADIUS server for authentication.

The following describes the settings for each Security Mode option.

WEP

- **TX Key**—Select the number of the key used for the wireless network.
- **WEP Encryption**—Select the appropriate option for key length based on your network settings.
- **Passphrase**—Type in the passphrase used to generate WEP keys for your network and click **Generate**.
- **Key 1-4**—Key values can be entered in manually or generated from a passphrase.

- **Authentication**—Select the appropriate authentication type used on the wireless network.

WPA /WPA2 Personal

- **Encryption**—This cannot be modified.
- **Shared Key**—Enter the shared key used for accessing the wireless network.

WPA /WPA2 Enterprise

The options vary depending on the protocol type selected.

- **Protocol Type**—Select EAP-TLS or EAP-TTLS.

EAP-TLS

- **User ID**—The user ID used to login to your RADIUS server.
- **Root CA**—A root certificate is an unsigned public key certificate or a self-signed certificate, which implies that you trust your browser's publisher to include correct root certificates and in turn the certificate authorities it trusts, and anyone to whom the CA may have issued a certificate-issuing-certificate, to faithfully authenticate the users of all their certificates.
- **User CA**—A user certificate is a signed private key certificate, which implies that you trust your browser's publisher to include correct user certificates and in turn the certificate authorities it trusts, and anyone to whom the CA may have issued a certificate-issuing-certificate, to faithfully authenticate the users of all their certificates.
- **Password**—This is for this camera's client login to the RADIUS server and must match the key stored on the RADIUS server.

EAP-TTLS

- **Process Method**—Choose an authentication method as required to handle the processing and transmitting of CA to your RADIUS server.
- **User ID**—The user ID used for login to your RADIUS server.
- **Password**—This is for this camera's client login to the RADIUS server.
- **Anonymous ID**—The unsigned public ID used for login to your RADIUS server.
- **Root CA**—A root certificate is an unsigned public key certificate or a self-signed certificate, which implies that you trust your browser's publisher to

include correct root certificates and in turn the certificate authorities it trusts, and anyone to whom the CA may have issued a certificate-issuing-certificate, to faithfully authenticate the users of all their certificates.

STEP 4 Click **Save** to save the wireless security settings and close the window.

STEP 5 From the Setup > Basic Setup window, click **Save** to save the wireless settings.

STEP 6 Disconnect the power to the camera.



STEP 7 Disconnect the Ethernet cable from the camera.





NOTE The wireless connection will not work if an Ethernet cable is attached to the camera when it is powered on.

STEP 8 Reconnect the power to the camera.

STEP 9 Click **Home** in the toolbar to verify the video is streaming from your wireless connection. You should be able to view video on the Home window.

Wired and Wireless Modes

**NOTE**

This section applies to the Cisco WVC2300 camera.

After the initial configuration, you can use the camera in one of two modes: wired or wireless. Verify the mode you are in by viewing the LEDs. You cannot use the camera in both modes simultaneously.

To switch between wired and wireless modes, see [“Moving the Camera to Another Network” on page 32](#).

Moving the Camera to Another Network

**NOTE**

This section applies to the Cisco WVC2300 camera.

When you move the camera from a wired network to a wireless network, or vice versa, you must power off the camera before connecting to the new network.

To move the camera from a wired network to a wireless network, follow these steps:

-
- STEP 1** Unplug the power adapter from the camera.
 - STEP 2** Unplug the Ethernet network cable from the camera.
 - STEP 3** Re-connect the power adapter to the Power port on the camera. The camera’s Ready LED flashes while the camera is initializing. The camera is ready for use when the Ready and Network LEDs are solidly lit.
-

To move the camera from a wireless network to a wired network, follow these steps:

-
- STEP 1** Unplug the power adapter from the camera.
 - STEP 2** Connect the Ethernet network cable to your PC, router, or switch.
 - STEP 3** Connect the other end of the cable to the Ethernet port on the camera.
 - STEP 4** Re-connect the power adapter to the Power port on the camera. The camera's Ready LED flashes while the camera is initializing. The camera is ready for use when the Ready and Network LEDs are solidly lit.
-

Upgrading the Camera Firmware

The Cisco PVC2300 and WVC2300 Internet Video Cameras may not always ship with the most up-to-date firmware. This chapter describes how to update the camera's firmware using the web-based configuration utility.



NOTE Microsoft Internet Explorer is the supported browser for the PVC2300 and WVC2300 cameras.

To access the web-based configuration utility, follow these steps:

-
- STEP 1** Launch a web browser, such as Internet Explorer.
- STEP 2** In the Address field, enter **192.168.1.99** and press **Enter**.
- The web-based utility login window appears.
- STEP 3** If this is your first time accessing the web-based utility, follow these steps at the login window:
- Enter **admin** in the User name field.
 - Enter **admin** in the Password field.
 - Click **OK**.
-

For security purposes, it is recommended that you later reset your password in the Administration > Users window.

To upgrade the camera firmware, follow these steps:

-
- STEP 1** Go to tools.cisco.com/support/downloads, and enter the model number in the Software Search box. Login is required.
 - STEP 2** Follow the online instructions to download the appropriate firmware to your computer.
 - STEP 3** Launch the web-based configuration utility. See [“Launching the Web-Based Configuration Utility” on page 36](#).
 - STEP 4** Click **Setup** in the toolbar.
 - STEP 5** Click **Administration > Firmware**. The current version is displayed.
 - STEP 6** Click **Upgrade**.
 - STEP 7** From the Upgrade Firmware window, click **Browse** to locate the firmware file.
 - STEP 8** Click **Upgrade** and follow the on-screen instructions.
-

**NOTE**

Cisco recommends that you upgrade the camera's firmware within your network. In other words, use a computer within the camera's local network. If you attempt to upgrade the camera's firmware from a remote location—using a computer outside of the camera's local network—the upgrade may fail.

Using the Web-Based Configuration Utility

This chapter describes the Cisco PVC2300 and WVC2300 Internet Video Camera's web-based configuration utility. The following sections are included:

- [Launching the Web-Based Configuration Utility, page 36](#)
- [Home, page 37](#)
- [Setup, page 41](#)

Launching the Web-Based Configuration Utility

By default, the cameras are set to receive an IP address from a DHCP server. If you do not have a DHCP server on your network, you can set a static IP address by pressing the **Reset** button on the camera for less than three seconds. A default IP address of 192.168.1.99 will be assigned to the camera.

To determine if you have a DHCP server on your network, consult your network administrator. If you do not have a DHCP server, access your camera using the default IP address.

To configure the PVC2300 or WVC2300 cameras, follow these steps to access the web-based configuration utility from your computer:

-
- STEP 1** Launch a web browser, such as Internet Explorer.
- STEP 2** In the Address field, enter **192.168.1.99** and press **Enter**. The web-based utility login window appears.

If you used the Setup Wizard to configure the IP address, use that same IP address in this step.

STEP 3 If this is your first time accessing the web-based utility, follow these steps at the login window:

- a. Enter **admin** in the User name field.
- b. Enter **admin** in the Password field.
- c. Click **OK**.

For security purposes, it is recommended that you later reset your password in the Administration > Users window.

Home

The Home window is the default display. From this window, live video can be viewed and the output can be updated. The camera type is identified in the upper left. You can always return to the Home window by clicking **Home** in the toolbar.

This section describes the options available to you on the Home window.

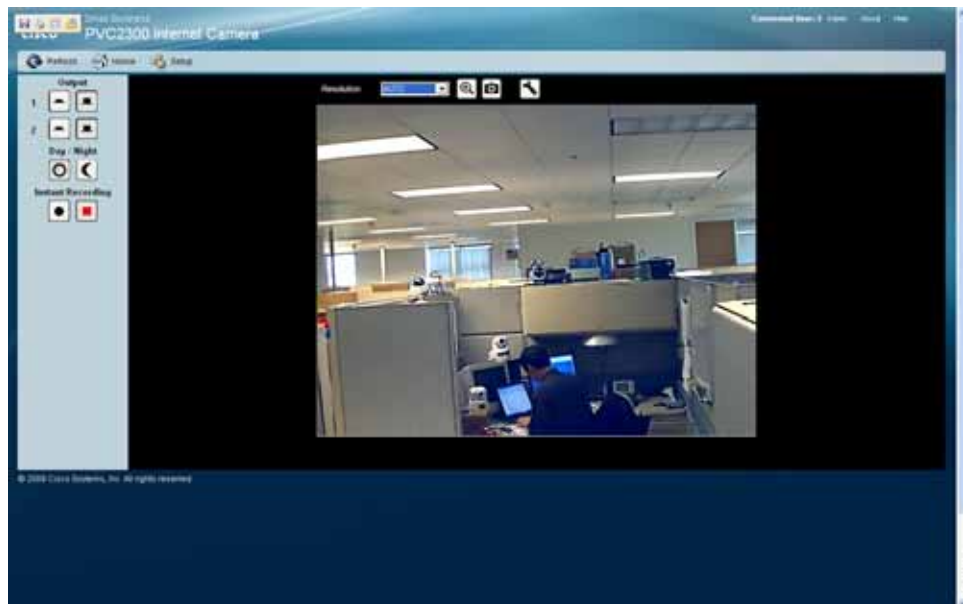

Refresh

Refreshes the display.

Setup

From Setup, you can view or configure the PVC2300 and WVC2300 camera features.

Connected User

Displays the number of users. The maximum number of users is 10.

Also, there are 10 video streams available for MJPEG and MPEG-4 in any combination, for example 5/5, 6/4, 7/3, 8/2, or 9/1.

Log Out

Log out from viewing the camera image.

About







Displays the camera software version.







Help



The camera software includes detailed Help files for all configuration tasks. To view a Help page, click the Help link in the top right corner of the window. A new window appears with information about the task that you are currently viewing.

Video Options Icons

The video options icons on the Home window are used to control the real-time view of your camera. The icons allow you to control the basic functions of the PVC2300 or WVC2300 cameras.

Icon	Description
On 	Click to turn on the selected output.
Off 	Click to turn off the selected output.
Day 	Uses the standard filter for day output.
Night 	Uses a filter for night vision.
Start Instant Recording  Stop Instant Recording 	<p>Click the black icon to start recording and click the red icon to stop recording. Consider the following:</p> <ul style="list-style-type: none"> The default location for saved recordings is <code>\MyDocuments\Record</code>. Click Browse to choose another location to save your recordings. Your folder selection is remembered in the registry. If that folder no longer exists the next time the camera is used, the default location is restored. The file name is saved in .avi format by default, and the maximum length for the video file is 30 minutes. If the recording is longer than 30 minutes, a second file is created automatically. The available disk space required is at least 750 MB.

Icon	Description
Preset Camera View	Select the preset area to patrol. See “Using Patrol Sequence” on page 88 for more information about setting these positions. This icon becomes visible after enabling RS-485.
Camera Patrol 	Move the camera one time through the preset positions. This icon becomes visible after enabling RS-485.
Move Controls 	<p>Allows you to incrementally adjust the camera in four (4) directions and back to home. There may be a short delay after a direction is clicked.</p> <p>The Move Control icon becomes visible after enabling RS-485. You also need to connect the camera to an external Pelco D protocol device for the Move Control to work.</p>
Resolution	Select the desired resolution from the drop-down list. The options are AUTO, 640 x 480, 320 x 240, 160 x 120. The default is AUTO and lets the camera determine the resolution.
Zoom 	Click zoom and then drag your mouse to select the section you want to magnify. Click the icon again to increase the zoom to x4 from x2.
Snapshot 	Click to take a single JPEG picture snapshot of the video image and save it to a desired location on your computer.
Audio On  Audio Off 	When the audio is enabled, an icon is displayed on the Home window and audio is picked up through the camera. You can then use the icons to turn the speaker on and off. To enable the sound, see “Audio/Video > Audio” on page 60 .

Icon	Description
<p data-bbox="443 359 613 390">Speaker On</p>  <p data-bbox="443 558 618 590">Speaker Off</p> 	<p data-bbox="768 359 1479 499">When the speaker is enabled, an icon is displayed on the Home window. You can then use the icons to turn the speaker on and off. To enable the speaker, see “Audio/Video > Audio” on page 60.</p>
<p data-bbox="443 741 683 804">Streaming Video Format</p> 	<p data-bbox="768 741 1430 772">Set the video format to either MPEG-4 or MJPEG.</p>

Setup

To access the setup options for the cameras, click **Setup** in the toolbar. For more information about Setup, see [Chapter 8, “Configuring the PVC2300 and WVC2300 Cameras.”](#)

Configuring the PVC2300 and WVC2300 Cameras

This chapter describes how to configure the Cisco PVC2300 and WVC2300 Internet Video Cameras using the web-based configuration utility. The following sections are included:

- [Accessing the Setup Options, page 43](#)
- [Setup > Basic Setup, page 44](#)
- [Setup > Advance Setup, page 49](#)
- [Setup > IP Filter, page 52](#)
- [Administration > Users, page 53](#)
- [Administration > Maintenance, page 54](#)
- [Administration > Firmware, page 55](#)
- [Audio/Video > Video, page 56](#)
- [Audio/Video > Audio, page 60](#)
- [Applications > Mail, page 62](#)
- [Applications > FTP, page 65](#)
- [Applications > Instant Messaging, page 67](#)
- [Applications > Motion Detection, page 68](#)
- [Applications > Event, page 70](#)
- [Applications > DDNS, page 74](#)
- [Applications > I/O Ports, page 75](#)
- [Applications > RS-485, page 77](#)
- [Applications > SMB/CIFS, page 81](#)

- [Status > System, page 82](#)
- [Status > Image, page 82](#)
- [Status > Network, page 83](#)
- [Status > Syslog & Log, page 84](#)
- [Status > Video Log, page 85](#)

Accessing the Setup Options

To access the setup options for your PVC2300 and WVC2300 cameras, follow these steps:

-
- STEP 1** Launch the web-based configuration utility. See [“Launching the Web-Based Configuration Utility” on page 36](#).
 - STEP 2** Click **Setup** in the toolbar.
 - STEP 3** Enter the default User name (**admin**) and the default password (**admin**).
 - STEP 4** Click **OK**.
-

There are five options displayed in the left panel: **Setup**, **Administration**, **Audio/Video**, **Applications**, and **Status**. Each option has windows that help you configure and manage the camera. The following sections provide descriptions and configuration settings for these options.

Setup > Basic Setup

The Setup > Basic Setup window displays the current device and network settings.

**NOTE**

If you are viewing the Setup > Basic Setup window of the WVC2300, the wireless settings are displayed also. See [“Wireless Settings” on page 46](#).

Device Settings

- **Camera Name**—Enter the preferred name for the camera. The camera name must not exceed 16 alphanumeric characters.
- **Description**—Enter a description of your camera, such as the location of the camera. Entering a description will help you identify the camera. It must not exceed 32 alphanumeric characters.
- **Enable LED Operations**—Check the check box if you want to turn on the LED.
- **Current Date/Time**—Displays the current date and time. Click **Change** to modify the time settings.

**NOTE**

To change the current date and time, uncheck the check box **Check here if you want to update the time automatically through the NTP Server on the Internet**.

Set Date/Time

- **PC's Date and Time**—Displays the current time of the PC connected to the web-based utility.
- **Camera Date and Time**—Displays the current time as configured on the camera.
- **Sync with PC**—Allows you to synchronize the camera to the clock on the PC connected to the web-based utility.
- **New Date**—Allows you to manually enter the date for the camera.

- **New Time**—Allows you to manually enter a new clock setting for the camera.
- **Set New Time**—Click to implement the new date or time setting.
- **Time Zone**—Choose the time zone for your location from the drop-down list.
- **Adjust for Daylight Saving Time**—Select this option if your location is currently using Daylight Saving Time. Uncheck the Adjust for Daylight Saving Time check box when Daylight Saving Time ends in your time zone.
- **Check here if you want to update the time automatically through the NTP Server on the Internet**—Enable or disable the time server feature as required. If enabled, the camera will contact a network time server at regular intervals and update its internal timer.
- **NTP Server Address**—Enter the address of the NTP Server.
- **NTP Port**—The default NTP port is 123. If using a different port, enter the NTP port number (1024 to 65535) in the field provided.

**NOTE**

If connecting to a router, it may be necessary to enable port forwarding. See [“Configuring Port Forwarding” on page 94](#).

Network Settings

- **Configuration Type**—From the drop-down list, choose the configuration type:
 - **Fixed IP Address**—Use this option to assign a fixed (static) IP address to the camera. Assign an IP address that is unique to your local network. When using a fixed IP address, you must configure the IP address, subnet mask, gateway, and DNS.
 - **Obtain An IP Address Automatically**—The camera defaults to this option, allowing a DHCP server on your network to automatically assign the camera an IP address.
- **IP Address**—IP address assigned to the camera.
- **Subnet Mask**—Subnet mask assigned to the camera.

- **Gateway**—IP address of the gateway router between this device and management stations that exist on other network segments.
- **Primary DNS**—The IP address of your ISP's primary server, which translates the names of websites into IP addresses.
- **Secondary DNS**—The IP address of your ISP's secondary server, which translates the names of websites into IP addresses.

Wireless Settings

**NOTE**

The wireless settings are only found on the WVC2300 camera.

- **SSID**—Enter the network's SSID or network name here. The default SSID name is `ciscosb`.
- **Security**—Click **Edit Security Settings** to display the Wireless Security window.
- **Security Mode**—Select the appropriate option based on your wireless network configuration. The options are Disabled, WEP, WPA/WPA2 Personal, WPA/WPA2 Enterprise.

Disable

This security mode option implements no security on your wireless network. Data is not encrypted before transmission.

WEP

Wired Equivalent Privacy (WEP) is a basic encryption method, which is not as secure as later methods such as WPA-Personal or WPA2 Personal.

- **TX Key**—Select the number of the key used on the wireless network.
- **WEP Encryption**—Select the appropriate option for key length based on your network settings.
- **Passphrase**—Type in the passphrase used to generate WEP keys on your network and click **Generate**.
- **Key 1-4**—Key values can be entered in manually or generated from a passphrase.

- **Authentication**—Select the appropriate authentication type used on the wireless network.

WPA /WPA2 Personal

This security mode option offers two encryption methods, TKIP and AES, with dynamic encryption keys. Enter the Shared Key, which can have 8 to 63 characters. Then enter the Key Renewal Timeout, which instructs the device how often it should change the encryption keys.

- **Encryption**—This cannot be modified.
- **Shared Key**—Enter the shared key used for accessing the wireless network.

WPA /WPA2 Enterprise

WPA2 Enterprise requires some advanced expertise because it involves setting up a RADIUS server for authentication and, in some cases, creation of certificates for both the RADIUS server and the camera.

If you are using WPA/WPA2 Enterprise security, you will need to upload security certificates to the camera. Certificates must be in the following format:

- **Root certificate:** DER encoded binary x.509 (CER/PEM)
- **User certificate:** Personal Information Exchange (PKCS# 12 (.PFX))

The configuration options for this security mode vary depending upon the protocol type selected.

- **Protocol Type**—Select EAP-TLS or EAP-TTLS.

EAP-TLS

With EAP-TLS you enter the user ID and password for the RADIUS server and choose where the camera should check for the server and user certificate.

WAP/WPA2 Enterprise (EAP-TLS)

- **User ID**—User ID is used to login to your RADIUS server.
- **Root CA**—A root certificate is an unsigned public key certificate, or a self-signed certificate, which implies that you trust your browser's publisher to include correct root certificates and in turn the certificate authorities it trusts, and anyone to whom the CA may have issued a certificate-issuing-certificate, to faithfully authenticate the users of all their certificates.

- **User CA**—A user certificate is a signed private key certificate, which implies that you trust your browser's publisher to include correct user certificates, and in turn the certificate authorities it trusts, and only user to whom the CA may have issued a certificate-issuing-certificate, to faithfully authenticate the users of all their certificates.
- **Password**—The login to the RADIUS server and must match the key stored on the RADIUS server.

EAP-TTLS

With EAP-TTLS you choose the authentication protocol (MS-CHAP V2, MS-CHAP, PAP, EAP-MD5) to transfer the CA to the RADIUS server. You will also enter the User ID, Password, and Anonymous ID for the RADIUS server and choose where the camera should check for the server certificate.

WPA/WPA2 Enterprise (EAP-TTLS)

- **Process Method**—Choose an authentication method (MS-CHAP, MS-CHAPv2, PAP, EAP-MD5) as required to handle the processing and transmitting of the CA to your RADIUS server.
- **User ID**—The user ID used for login to your RADIUS server.
- **Password**—This camera's client login to the RADIUS server and must match the key stored on the RADIUS server.
- **Anonymous ID**—The unsigned public ID used for login to your RADIUS server.
- **Root CA**—A root certificate is an unsigned public key certificate, or a self-signed certificate, which implies that you trust your browser's publisher to include correct root certificates, and in turn the certificate authorities it trusts, and anyone to whom the CA may have issued a certificate-issuing-certificate, to faithfully authenticate the users of all their certificates.

Setup > Advance Setup

From the Setup > Advance Setup window you can configure settings for HTTP/HTTPS, RTP/RTSP, UPnP, Bonjour, QoS, and CoS.

HTTP/HTTPS

- **Enable HTTP Alternative Port**—Allows you to define the port number used to communicate with the camera using an HTTP connection. The default value is **1024**. A value in the range of 1024-65535 can be defined.

The port number must be specified in the URL when accessing the camera's web-based utility via the LAN or Internet. For example, if the camera's IP address is 192.168.1.99 and the port is defined as 1028, you would specify the following address: **http://192.168.1.99:1028**.

- **Enable HTTPS Alternative Port**—Allows you to define the port number used to communicate with the camera using an HTTPS connection. The default value is **1024**. A value in the range of 1024-65535 can be defined. When using a secure connection, video is not available. This option is used only for configuration.

The port number must be specified in the URL when accessing the camera's web-based utility via the LAN or Internet. For example, if the camera's IP address is 192.168.1.99 and the port is defined as 1032, you would specify the following address: **https://192.168.1.99:1032**.

RTP/RTSP

RTSP (Real Time Streaming Protocol) is a standard for connected client(s) to control streaming data (MPEG-4) over the Internet.

RTP (Real-Time Transport Protocol) is an Internet protocol used for transmitting single real-time multimedia data such as audio and video to a select group of connected clients. RTSP uses RTP to format packets of multimedia content.

- **RTSP Port**—Enter the RTSP Port number (between 1024 to 65535) in the field provided. The default RTSP port is **554**.
- **RTP Data Port**—The camera's data port number has been pre-configured and can be used for multicasting. It does not normally need to be re-configured. If a port number does need to be changed, please contact your

network administrator. If a change is necessary, enter the data port number (1024 to 65535) in the field provided. The default RTP port is **5000**.

- **Max RTP Data Packet**—Allows you to define the maximum size of the RTP data packets. The length can be between 400 to 1400 bytes. The default value is **1400** bytes.
- **Enable Multicast**—The camera's video and audio IP addresses have been pre-configured and can be used for multicasting. Normally these settings do not need to be reconfigured. If an address does need to be changed, contact your network administrator.

Enable Multicast

The following configuration options are displayed when you check the Enable Multicast check box.

- **Group Name**—If Group Name does need to be changed, contact your network administrator. To change, enter the Group Name in the field provided.
- **Video Address/Audio Address**—The camera's Video and Audio IP Address have been pre-configured and can be used for multicasting. This does not normally need to be re-configured. If an address does need to be changed, please contact your network administrator. To change, enter the Video Address/Audio Address in the field provided.
- **Video Port/Audio Port**—The camera's Video and Audio Port number has been pre-configured and can be used for multicasting. This does not normally need to be re-configured. If a port number does need to be changed, please contact your network administrator. To change, enter the Video Port/Audio Port number (between 1024 to 65534) in the field provided. The Video Port / Audio Port number you entered must be even values.
- **Time to Live**—Define the number of hops (the number of network routers that can be passed before the multimedia data packets arrive at their destination or are dropped) that can occur before the packets are dropped. A value in the range of 1 to 255 can be defined. The default value is **16**.

UPnP

- **Enable UPnP Discovery**—If enabled, the camera broadcasts its availability through Universal Plug and Play protocol (UPnP). UPnP compatible systems such as Windows XP will then be able to detect the presence of the

camera. For instructions about setting up UPnP on your system, see [Appendix A, “Troubleshooting.”](#)

- **Enable UPnP Traversal (Port Mapping)**—When enabled will create a port forwarding rule on a NAT router automatically for opened HTTP, HTTPS, RTP, and RTPS ports.



NOTE UPnP must be enabled on the NAT router for the Enable Traversal feature to work.

Bonjour

- **Enable Bonjour**—Enabled by default. If enabled, the camera is accessible using a Bonjour-enabled browser, such as Microsoft Internet Explorer with a Bonjour plug-in, or the Apple Mac Safari browser. By using Bonjour, you can easily find and click on Bonjour-enabled items on your network.

QoS

- **Enable QoS Mode**—Quality of Service (QoS) mode is disabled by default. To enable the QoS mode, select this option and select either audio, video, or both for its guaranteed throughput level. Enable QoS mode will automatically enable WMM (802.11e QoS) when in wireless mode. WMM Wi-Fi Multimedia (WMM) is a standard created to define QoS in Wi-Fi networks.
- **DSCP**—If QoS is enabled, enter the Differentiated Services Code Point (DSCP) to be used in processing QoS packets. The default value is 12.

CoS

- **Enable CoS Mode**—Class of Service (CoS) mode is disabled by default. To enable CoS mode, check the check box.
- **Priority**—Priority can be set to a value between 0 to 7. The highest priority value is 7.
- **VLAN ID**—Enter the VLAN ID (1 to 4095).

The 802.1p header includes a three-bit field for prioritization, which allows packets to be grouped into various traffic classes. The IEEE has made broad recommendations concerning how network managers can implement these traffic classes, but it stops short of mandating the use of its recommended traffic class definitions. It can also be defined as best-effort QoS (Quality of Service) or CoS (Class of Service) at Layer 2 and is implemented in network adapters and switches without involving any reservation setup. 802.1p traffic is simply classified and sent to the destination; no bandwidth reservations are established.

Setup > IP Filter

From the Setup > IP Filter window, you can configure IP Filter Settings to deny or allow camera access to a specific IP address or range of IP addresses.

IP Filter Settings

- **IP Filter Settings**—Select from the following options:
 - **Disable**—Disables IP filtering.
 - **Enable and Deny the Following IP Address**—Allows you to deny access to a specific IP address or range of IP addresses. From the drop-down list, select **Single** to enter a specific IP address or **Range** to enter a range of IP addresses. Up to 10 values can be configured.
 - **Enable and Allow the Following IP Address**—Allows only the IP addresses specified access to the camera. From the drop-down list, select **Single** to enter a specific IP address or **Range** to enter a range of IP addresses. Up to 10 values can be configured.

Filtering List—The IP filter setting allows up to maximum of 10 single IP address or 10 ranges of IP addresses.

Administration > Users

From the Administration > Users window, you can change the administrator password, modify demo account settings, and create or modify a user list.

Administrator

- **Admin**—The default administrator name cannot be changed but the password can and should be changed for security purposes. To change the password, enter the desired password in the Password and Confirm Password fields. Click **Change** to apply the change.

Demo

- **Viewer**—This account allows the viewing of video only. By default, the account name is **demo** and there is no password assigned. To change the demo account settings, modify the user name and password in the appropriate fields and click **Change**.

User List

- **User ID**—The User ID cannot be modified because it is pre-configured in sequential order.
- **User Name**—Enter the desired user name. Note that spaces, punctuation, and special characters are not supported. The name is case-sensitive. User name cannot exceed 32 characters.
- **Password**—Enter the desired password in this field. Password cannot exceed 64 characters.
- **Confirm Password**—Retype the password in this field.
- **Privilege Level**—Select the appropriate privilege level from the drop-down list. Choose from one of the following options:
 - **Administrator**—Provides the specified user full camera administration and control privileges.
 - **Monitor**—Provides the specified user control of the camera video (manually pan/tilt, toggle between day/night vision, and trigger output ports).

- **Viewer**—Provides the specified user video viewing privileges only.

Click **Add** to add a new user ID or click **Delete** to remove an existing user ID. Click **Save** to save the user configuration.

Administration > Maintenance

From the Administration > Maintenance window, you can restore factory defaults, restart the camera, save the configuration settings, or upload a configuration file.

Restore Factory Defaults

- **Restore**—Restores the camera to the factory default settings.

Restart

- **Restart**—Restarts the camera.

Configuration

- **Save**—Save a configuration file containing all of the current camera management settings.
- **Browse**—Locate a previously saved configuration file.
- **Upload**—Upload a previously saved configuration file into the camera.

Administration > Firmware

The Administration > Firmware window allows you to upgrade the firmware.

Firmware Upgrade

- **Upgrade**—Update the camera's firmware. For more information, see [Chapter 6, "Upgrading the Camera Firmware."](#)

Audio/Video > Video

The Audio/Video > Video window displays the video settings.

**NOTE**

Higher video quality settings and higher frame rate settings require more bandwidth. See [Appendix B, “WVC2300 Camera Bandwidth Test”](#) for additional details.

MPEG-4 Settings

MPEG is the designation for a group of audio and video coding standards and related technology agreed upon by the ISO/IEC. The primary uses for the MPEG-4 standard are web (streaming media), CD distribution, and broadcast television.

- **Resolution**—Select the desired video resolution setting. The default resolution is **320x240**.
- **Video Quality Control**—Choose one of the following:
 - **Constant Bit Rate**—Select the constant bit rate. The default value is **256 Kbps**.
 - **Fixed Quality**—Select the desired fixed quality. The default is **Normal**.
- **Max Frame Rate**—Select the desired maximum frame rate. The default value is **30 fps**.

MJPEG Settings

MJPEG (Motion JPEG) is a video codec where each video field (frame) is separately compressed into a JPEG image.

- **Resolution**—Select the desired video resolution format. The default resolution is **320x240**.
- **Fixed Quality**—Select the desired fixed quality. The default is **Normal**.
- **Max Frame Rate**—Select the desired frame rate. The default value is **30 fps**.

Mobile Settings

- **Enable Mobile Streaming**—Check the check box to enable streaming video for the mobile devices.
 - **Resolution**—The default resolution is **160x120**.
 - **Video Quality Control**—Choose from one of the following options:
 - **Constant Bit Rate** — Select the desired constant bit rate. The default value is **32 Kbps**.
 - **Fixed Quality** — Select the desired fixed quality. The default is **Normal**.
 - **Max Frame Rate**—Select the desired maximum frame rate. The default value is **15 fps**.
 - **Access Code**—Entered at the end of a URL to access a live video camera feed through another source, for example, a cell phone connection:

```
rtsp://<IP Address>/access_code
```

Video Adjustments

- **Power Line Frequency**—Select the power line frequency (50Hz or 60Hz) used in your region, to improve the picture quality under fluorescent lighting.
- **White Balance**—Select the suitable white balance. Options are auto or black and white.
- **Brightness**—If necessary, you can adjust the brightness to obtain a better image. For example, if the camera is facing a bright light, the image may be too dark. In this case, you can increase the brightness.
- **Sharpness**—Adjust the sharpness to obtain a better image. You can select a sharpness value between -3 and 3.
- **Contrast**—Adjust the contrast to obtain a better image. You can select a contrast value between -3 and 3.

Options

- **Enable Time Stamp**—To display a time stamp on the video, enable this feature by checking the check box.
- **Enable Text Display**—To display text on the video, enable this feature by checking the check box. The text can be up to 20 characters in length. This feature is often used to identify the camera location when multiple cameras are installed.
- **Enable Image Overlay**—To display an image on the video, enable this feature by checking the check box.
- **Cisco Logo**—When selected, a Cisco logo will display at the top of the video. Positioning of the logo is determined by the x and y coordinates defined in the Image Position fields.
- **User Defined Image**—Allows you to upload a 24-bit bitmap image file (smaller than 64Kb).
- **Image Position**—The Image Position fields allow you to define the coordinates of the Cisco logo or user defined image. The upper left corner value is 0, 0. Increasing the X value (X: 0 - 639) will move the image to the right. Increasing the Y value (Y: 0 - 479) will move the image down.

**NOTE**

Select values within the range of the selected image resolution.

- **Transparent Color**—You can define a color that should appear transparent. This allows a logo or other image to appear over the video without displaying a solid background color. The color value must be entered in RGB hexadecimal color code, such as FFFFFFFF.

Day/Night Switch

Color cameras can capture infrared radiation as well as visible light. The camera is equipped with an IR-cut filter that prevents distortion of colors the human eye can see. To use the camera in locations with poor lighting or at night, the IR-cut filter can be manually turned off or a schedule can be used to turn off the filter at a set time. An infrared lamp can be used to improve illumination in night surveillance applications without producing any extra visible light. This is all done by using the IR filter that is built-in to the camera.

- **Enable Night Vision Schedule**—Enable Day/Night switch schedule by checking this check box.
- **Start Time**—Select the evening start time by selecting the hour and minute. Use the 24-hour time format.
- **End Time**—Enter the hour in the morning to end the night vision feature, by selecting the hour and minute. Use the 24-hour time format.

Audio/Video > Audio

From the Audio/Video > Audio window, you can enable audio and configure the audio settings.

Audio Settings

- **Enable Audio**—Enable audio by checking the Enable Audio check box. When audio is enabled, an icon is displayed on the Home window and audio is picked up through the camera. You can use the icons to turn audio on and off.

Audio On



Audio Off



Mode	Function
Simplex - Talk Only	Enables the speaker jack
Simplex - Listen Only	Enables the microphone jack
Half Duplex - Talk or Listen (Not simultaneously)	Enables the speaker and microphone jack but only one can be used at a time
Full Duplex - Talk and Listen (Can be simultaneously)	Enables the speaker and microphone jack and both can be used simultaneously

- **Audio Type**—When the microphone is enabled, this drop-down menu allows you to select the audio compression type.

Setting	Description
G.726	Default audio compression algorithm, uses 32 Kbps of bandwidth with quality similar to G.711 but using only half of the bandwidth.
G.711 A-Law	A standard compression algorithm that uses 64 Kbps of bandwidth and is primarily used in Europe.
G.711 μ -Law	A standard compression algorithm that uses 64 Kbps of bandwidth and is primarily used in North America and Japan.

- **Enable Speaker**—Check the box to activate an optional external speaker. When the speaker is enabled, an icon is displayed on the Home window. You can then use the icons to turn the speaker on and off.

Speaker On



Speaker Off



Applications > Mail

From the Applications > Mail window, you can configure and test primary and secondary SMTP servers. You can also configure the e-mail setup.

**NOTE**

Only one SMTP server is used, even if both the primary and secondary SMTP servers are enabled. The secondary SMTP server is used if the camera cannot connect to the primary server. Configuring a secondary SMTP server is optional.

Primary SMTP Server

- **Primary SMTP**—Check the check box to upload to the primary SMTP server.
- **SMTP Mail Server**—Enter the address of the Simple Mail Transport Protocol (SMTP) server to be used to send e-mail. You can use the IP address or the domain name.
- **Port**—Enter the port number of the mail server. The default is 25.
- **Authentication**—From the drop-down list, choose one of the following options:
 - **Not Required**—Authentication is not required to send mail.
 - **Requires SMTP Authentication**—Select if the SMTP server requires a login to send mail.
 - **Requires POP before SMTP**—Select if the SMTP server requires a POP login to send mail.
- **Account Name**—Enter the account name to be used on the e-mail server.
- **Password**—Enter the password associated with the account name.
- **POP Server Name**—Enter the hostname or IP address of the POP3 mail server that is being used to receive e-mail.
- **Test SMTP Server**—Click to test the configuration. You will get an error message if the transaction does not complete. For example, test fails due to a wrong username or password.
- **Requires SSL Encryption**—Check the check box if your mail server requires SSL encryption. This option supports cryptographic protocols that

provide security and data integrity for communications over TCP/IP networks such as the Internet.

Secondary SMTP

- **Secondary SMTP**— (Optional) Check the box to upload to the secondary SMTP server if the camera cannot connect to the primary SMTP server.
- **SMTP Mail Server**—Enter the address of the Simple Mail Transport Protocol (SMTP) server to be used to send e-mail. You can use the IP address or the domain name.
- **Port**—Enter the port number for the mail server. The default is 25.
- **Authentication**—From the drop-down list, choose one of the following options:
 - **Not Required**—Authentication is not required to send mail.
 - **Requires SMTP Authentication**—Select if the SMTP server requires a login to send mail.
 - **Requires POP before SMTP** — Select this if the SMTP Server requires a POP login to send mail.
- **Account Name**—Enter the account name to be used on the e-mail server.
- **Password**—Enter the password associated with the account name.
- **POP Server Name**—Enter the name of the POP3 mail server that is being used to receive e-mail.
- **Test SMTP Server**—Click to test the configuration. You will get an error message if the transaction does not complete. For example, test fails due to a wrong username or password.
- **Requires SSL Encryption**—Check the check box if your mail server requires SSL encryption. This option supports cryptographic protocols that provide security and data integrity for communications over TCP/IP networks such as the Internet.

E-mail Setup

- **Send To**—Enter at least one e-mail address. The second and third addresses are optional. The e-mail alert is sent to the e-mail address or addresses specified here.
- **Show From as**—Enter the e-mail address to be shown in the From field when the e-mail is received.
- **Subject**—Enter the desired text to be shown as the subject for the e-mail when it is received. Maximum field length is 48 characters.

E-mail Body

- **Attach Video Streaming URL Address**—This option attaches streaming video URL address.

Applications > FTP

From the Applications > FTP window, you can configure a primary and secondary FTP server.

**NOTE**

Only one FTP server is used, even if both the primary and secondary FTP servers are enabled. The secondary FTP server is used if the camera cannot connect to the primary server.

Primary FTP

- **Primary FTP**—Check the check box to upload to the primary FTP server.
- **FTP Server**—Enter the address of the primary FTP server. You can use the IP address or the domain name.
- **Port**—Enter the port number for the primary FTP server. The default is 21.
- **Login Name**—Enter the login name associated with the specified primary FTP server.
- **Password**—Enter the password associated with the login name for the primary FTP server.
- **File Path Name**—Enter the desired file path name on the primary FTP server.
- **Enable Passive Mode**—Check the box to enable the passive mode feature. Passive mode is a more secure form of data transfer. The use of passive FTP ensures all data flow initiation comes from inside the network rather than from the outside.

Secondary FTP

- **Secondary FTP**—Check the check box to enable. When enabled, the camera will connect to a secondary FTP server if the primary FTP server is not available
- **FTP Server**—Enter the address of the secondary FTP server.
- **Port**—Enter the port number for the secondary FTP server. The default is 21.

- **Login Name**—Enter the login name associated with the secondary FTP server.
- **Password**—Enter the password associated with the login name for the secondary FTP server.
- **File Path Name**—Enter the desired file path name on the secondary FTP server.
- **Enable Passive Mode**—Check the box to enable the passive mode feature on the secondary FTP server. Passive mode is a more secure form of data transfer. The use of passive FTP ensures all data flow initiation comes from inside the network rather than from the outside.

Applications > Instant Messaging

From the Applications > Instant Messaging window, you can configure Jabber for instant messaging.

Jabber

Enable Jabber—Check the box for the camera to logon to the Jabber server.

Jabber is an instant messaging service (IM) that is based on Extensible Messaging and Presence Protocol (XMPP) and geared to provide message exchange in real time between two points on the Internet. Jabber is similar to IM systems such as AIM, ICQ and MSN but is open source, extensible through XML, and decentralized (allowing anyone to run a Jabber server). The following are the Jabber settings:

- **Jabber Server**—Enter the address of your Jabber server.
- **Login ID**—Enter the login name for your Jabber server.
- **Password**—Enter the password for your Jabber server
- **Send To**—Enter the jabber address where you would like to send the message to, in case of an alert. For example, john@jabber.org.
- **Message**—Enter the message you want to attach.

Applications > Motion Detection

From the Applications > Motion Detection window, you can set the area(s) of the video image to be examined and adjust the sensitivity of detection for each area.

**NOTE**

Motion detection cannot be configured using the Firefox browser. Internet Explorer must be used to configure motion detection.

**NOTE**

Motion detection can be triggered by rapid changes in lighting conditions, as well as by moving objects. For this reason, it should only be used indoors.

When you first select the Motion Detection option, you are prompted to install an Active-X plug-in. It is necessary to install this plug-in to use this feature.

Active-X Message



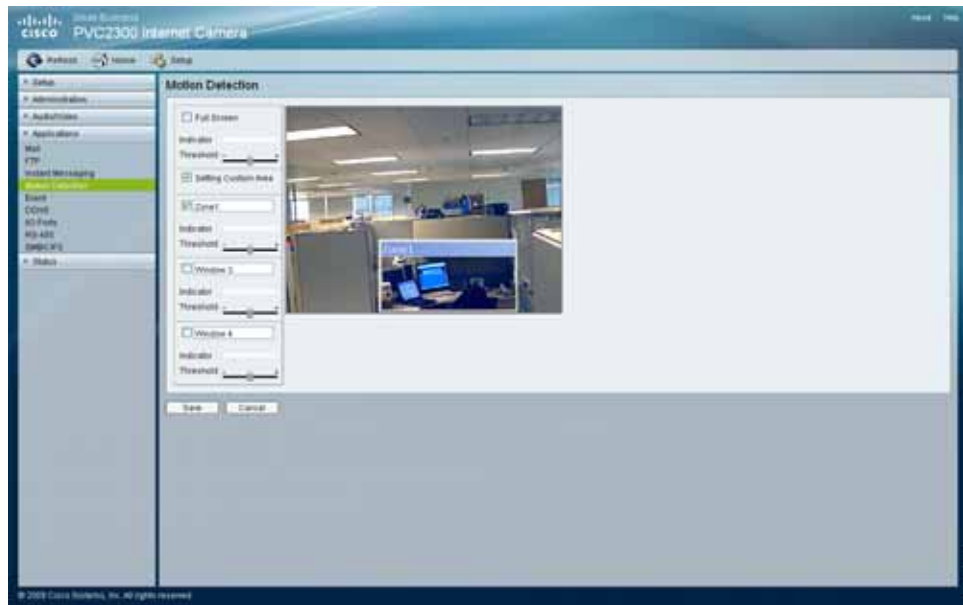

- **Full Screen**—Enable this option to detect motion events within the full view of the screen.
 - **Indicator**—Displays the level of motion detected. This option cannot be configured but is useful for determining a motion threshold.
 - **Threshold**—Adjusts the motion sensitivity.
- **Setting Custom Area**—Enable this option to capture motion within defined areas of the video screen. Multiple windows with varied threshold settings may be used.
 - **Window 2-4**—Enable one or more of these options to detect motion in specific areas of the video screen. Windows can be defined by simply extending the window with the cursor. More than one window can be used at once.
 - **Indicator**—Displays the level of motion detected. This option cannot be configured but is useful for determining a motion threshold.
 - **Threshold**—Adjusts the motion sensitivity.

Applications > Event

The Applications > Event window is used to set up the camera applications functions.

Operating mode allows you to configure Event Trigger settings. A triggered event is a set of parameters describing how and when the camera will perform certain triggered actions, according to requirements.

The most common kind of event type will upload video or snapshot files to a specified destination (E-mail account or FTP server). Other actions performed by event types can include the activation of an output port.

**NOTE**

It is important to note that adding a new event will stop any event that is currently running. A scheduled event will automatically resume, if the time is still within the scheduled period. A triggered event will need to be re-triggered.

Event Schedule

The Event Schedule displays the effective time frame and start/end times for scheduled events. It contains a current profile of the event schedules. You can delete an existing event schedule.

New Schedule

**NOTE**

The camera can be configured for up to 10 events.

- **Effective Time Frame**—From the drop-down list, select the event time frame. Available options are every day, weekdays, or a specific day of the week.
- **Start Time**—Select the event start time in hours and minutes. Use the 24-hour time format.
- **End Time**—Select the event end time in hours and minutes. Use the 24-hour time format.

Click **Add** to add a new schedule or **Clear** to clear options and enter a new schedule.

Trigger Event

A triggered event type is activated when a specific internal or external trigger condition is met. These triggers are:

- A signal from a device connected to an input on the camera. For example, a signal from a door switch.
- When movement is detected in a previously configured motion detection window.

The configuration options for trigger event are:

- **Enable**—Check the box to perform all of the event(s) that are configured and scheduled.
- **Interval**—Defaults to zero minutes before detecting the next event. Select the desired interval before detecting the next event. (0 min = No Delay)
- **Triggered by**—Check the box to select a trigger option:
 - **Input 1/2**—Describes the states that the input(s) must be in for an event to be triggered. Only one input can be used. Also, note that the states for all the inputs used must first be reached before the event will be triggered.
 - **Motion Detection**—Movement in a motion detection window can be used to trigger events.
- **Action(s)**—Select one or more actions to perform once a trigger event occurs. Choose from the following options:
 - **E-mail**—If checked, an e-mail with attachments (image or video) will be delivered to the SMTP server when an alert is detected. E-mail alerts require pre-configured e-mail settings in the Applications > Mail window. See [“Applications > Mail” on page 62](#).
 - **FTP**—If checked, an FTP upload with attachments (image or video) will be activated to the FTP server when an alert is detected. A secondary server may also be specified, if required. This will be used if the primary server is unavailable. FTP alerts require pre-configured FTP settings in the Applications > FTP window. See [“Applications > FTP” on page 65](#).
 - **SMB/CIFS**—If checked, attachments (image or video) are uploaded to the NAS device defined in the Applications > SMB/CIFS window when an alert is detected. See [“Applications > SMB/CIFS” on page 81](#).

The following SMB/CIFS settings are visible when SMB/CIFS is enabled:

- **Enable SMB/CIFS**—Check the box to enable SMB/CIFS alerts. Alerts are recorded and sent to the NAS device (SMB/CIFS server).
- **Upload Path**—Enter the folder name to upload alert notification to a NAS device (SMB/CIFS server).
- **Login Name**—Enter the user's login name for the NAS device (SMB/CIFS server).
- **Password**—Enter the user password for the NAS device (SMB/CIFS server).
- **Output 1/2**—If checked, the output port(s) state will be activated when an alert is detected. Output port(s) alerts require pre-configured I/O port setting in the Applications > I/O Ports window. See [“Applications > I/O Ports” on page 75](#).
- **Instant Messaging**—If checked, an instant message will be delivered to the Jabber server when an alert is detected. Jabber alerts require pre-configured Jabber settings in the Applications > Instant Messaging window. See [“Applications > Instant Messaging” on page 67](#).

Event Attachment

When trigger events are enabled and an e-mail or FTP action is selected, the following options are enabled:

- **Overwrite/Replace oldest video file**—Check the box to overwrite and replace the oldest video clip with the current recording when detecting device's SDRAM is full.
- **Attachment Type**—From the drop-down list, select the type of attachment:
 - **JPEG Image**—Select to send image captures.
 - **Frame Rate**—Select the desired capture rate for the JPEG image(s).
 - **Pre/Post Capture**—Select the desired length. The snapshot(s) of the JPEG image depends on this setting, and also the file size and degree of compression.
- **Video**—Select to send video captures.

- **Video Format (MPEG-4 Mode Only)** — Select the format for the video file.
 - **ASX**: Advanced Stream Redirector. Media container file based on XML metadata to store a list of Windows Media files.
 - **MP4** (no audio)
 - **3GP** (no audio)
- **Pre/Post Capture**—Select the desired length. The size of the file depends on this setting, and also the video size and degree of compression.

Applications > DDNS

From the Applications > DDNS window, you can configure Dynamic Domain Name Service (DDNS). Use this feature to access the camera from a remote location.

DDNS

- **Enable DDNS**—Check the box to enable DDNS. When used with a DDNS service provider, you can access your camera over the Internet using a domain name instead of an IP address.
- **Service Provider**—Select the service provider that you have an account with. The choices are DynDNS, TZO, and 3322. If you do not have an account, you can select a service provider and click **Web Site**.
- **Host Name**—Enter the host name (Domain Name) allocated to you by the DDNS service provider.
- **Account**—Enter the login name for the DDNS account.
- **Password**—Enter the password for the DDNS account.
- **Check WAN IP Address**—This option allows you to set how often the device should check to see if the Internet IP address has changed. If the IP address has changed, the DDNS server will be notified.
- **Starting at**—Allows you to set when to start checking if the IP address has changed.

**NOTE**

To complete the DDNS service setup, port forwarding needs to be configured on your router. See [“Configuring Port Forwarding” on page 94](#).

Applications > I/O Ports

From the Applications > I/O Ports window, you can configure the Input and Output port states.

See the I/O port specifications in [Appendix C, "Specifications"](#) for additional details.

Input Ports

- **#**—Displays the port number.
- **Current State**—Indicates the current status of input device (for example, alarm sensor or smoke sensor) that you connected.
- **Triggered When**—You can set four triggering conditions. The input port will be activated if the triggering condition changes so that it no longer equals to the current state.
 - High
 - Low
 - Rising
 - Falling

Output Ports State at Power On

With the camera, as long as both output's Default and Current State is High, the output is disconnected (floating). When the current State changes to Low or Low Pulse, the output will be activated.

- **#**—Displays the port number.
- **Current State**—Displays the current state of the port.
- **Default State**—The default setting for the Default State option is **High**. While the camera is restarting, the output will be in the Default State (i.e. High) for at least as long as it takes for the camera to fully initialize. Please consider this carefully when connecting equipment to the output. After a full restart, the unit will then switch to Low or Low Pulse (but only if configured to do so).

- **Output State**—Changing and saving Output State settings on this page will also reset outputs to their Default States. The state will correct the next time the triggering event activates the output.

Output Ports Manual Control

- **#**—Displays the port number.
- **Action Definition**—Defines the output port mapping.

Applications > RS-485

From the Applications > RS-485 window, you can define port settings, such as the baud rate, data bits, and parity type. You can also define the camera preset point position and configure how the camera will move when set to rotate.

- **Enable RS485**—If the RS485 feature is enabled, valid command(s) must be provided as requested by the connected device(s).

Port Settings

- **Baud Rate**—Select the desired baud rate for the device you connected.
- **Data Bits**—Select the desired data bits for the device you connected.
- **Parity**—Select the desired parity type for the device you connected.
- **Stop Bits**—Select the desired stop bits for the device you connected.
- **Address**—Enter the valid logical address of the receiver/driver being controlled.

Preset Position

- **Set Preset Position**—Click to display the Set Pan/Tilt window that allows you to define the preset point position.

Pan/Tilt

- **Set Home**—Set the desired position and click **Set Home** to define the home position.
- **Preset List**—Select the desired preset position and the screen will update with the current data for the selected preset. If you don't need the desired preset position, click **Remove**.
- **Preset Name**—Enter a suitable name for the current desired position and then click **Add** to add to the preset list.
- **Pan Speed**—Select the desired speed for camera panning. Default value is 5.
- **Tilt Speed**—Select the desired speed for camera tilting. Default value is 5.

Patrol Sequence

This feature determines how the camera will move when it is set to rotate. You can set a number of preset positions. The camera will go to the first position, then move through the list of preset positions until it is finished. The camera will stop at the last position in the list.

To create the preset sequence, select the desired Preset in the left column and click **Add >>**. Repeat until the desired sequence is complete.

**NOTE**

You can add the same preset position more than once. This can be used to make the camera stay longer at one position.

To delete a position from the sequence, select the desired position and click **Remove**.

- **Preset**—Displays a list of available presets to choose from.
- **Sequence**—Displays the order of presets in the sequence.
- **Add >>**—Adds a preset to the sequence.
- **Remove**—Removes a preset from the sequence.

To set the camera to rotate, follow these steps:

STEP 1 From the Applications > RS-485 window, check the check box **Enable RS485**.

STEP 2 Click **Preset Position**.

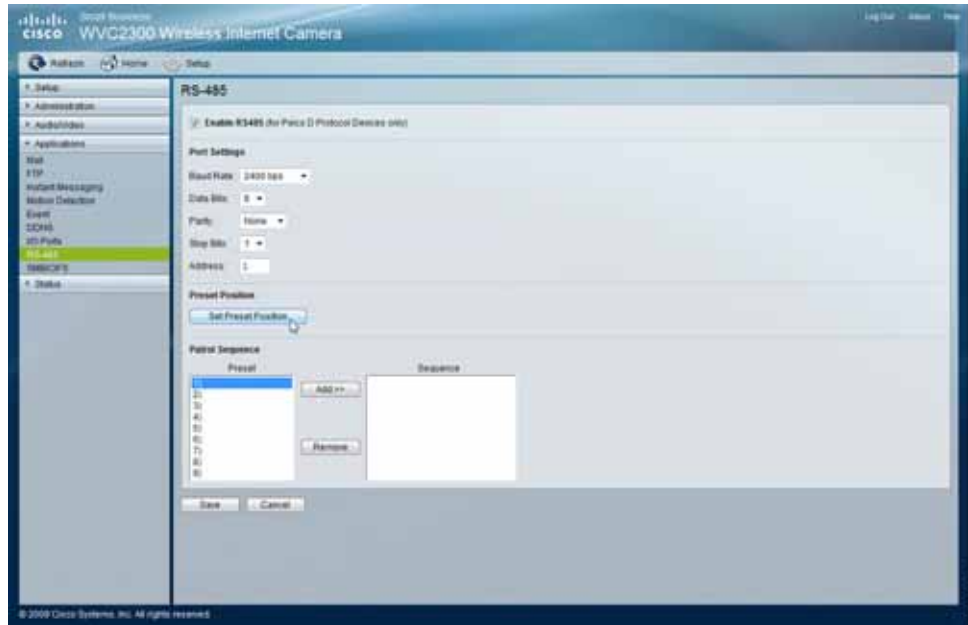

The Set Pan/Tilt window displays.



STEP 3 From the Set Pan/Tilt window, configure the following options:

- **Preset Name**—Enter a suitable name for the current desired position.
- **Pan Speed**—Select the desired speed for camera panning.
- **Tilt Speed**—Select the desired speed for camera tilting.

STEP 4 Click **Add** to add to the preset list or **Back** to return to the previous screen.

Applications > SMB/CIFS

The Applications > SMB/CIFS window shows options for SMB/CIFS. SMB/CIFS allows the camera to record directly into a Network Attached Storage (NAS) device. There is no need to record to a computer and keep a computer active all the time.

- **Enable SMB/CIFS Recording**—When enabled, provides seamless file recording and uploading to a NAS device. The TCP/IP protocol installed on the NAS device is used for file transfer.
- **SMB/CIFS Server**—Enter the server hostname or IP address of your NAS device (SMB/CIFS server).
- **Upload Path**—Enter the folder name to upload video to the NAS device (SMB/CIFS server).
- **Login Name**—Enter user's login name for the NAS device (SMB/CIFS server).
- **Password**—Enter user's password for the NAS device (SMB/CIFS server).
- **Maximum Size of Each File (MB)**—Enter the maximum file size to upload to the NAS device (SMB/CIFS server).
- **Enable adding timestamp to files**—When enabled, a timestamp is added to each recorded file and there will be multiple recorded files. Older files will not be over-written, so the size of your recording will continuously grow. If disabled, first video image is timestamped; any images saved thereafter are not timestamped.

Status > System

The Status > System window displays the camera system status information such as firmware version, IP address, MAC address, date, and time.

- **Firmware Version**—Version of the firmware currently installed. Firmware can be upgraded from the Administration > Firmware window. You must be logged in with administrator privileges to upgrade the firmware.
- **IP Address**—Displays the IP address of the camera.
- **MAC Address**—Displays the MAC address of the camera.
- **Camera Name**—Displays the name of the camera, as defined in the Setup > Basic Setup window. By default, the last six digits of the camera name come from the last three bytes of the MAC address.
- **Description**—Displays the description of the camera, as defined in the Setup > Basic Setup window.
- **Date/Time**—Displays the current date/time configured on the camera.

Status > Image

The Status > Image window displays MPEG-4 and MJPEG image status.

MPEG-4

- **Resolution**—Displays the image size of the video stream.
- **Image Quality**—Displays the image quality of the video stream.
- **Frame Rate**—Displays the frame rate of the video stream.

MJPEG

- **Resolution**—Displays the image size of the video stream.
- **Image Quality**—Displays the image quality of the video stream.
- **Frame Rate**—Displays the frame rate of the video stream.

Status > Network

The Status > Network window displays the network information, such as IP address, gateway, primary and secondary DNS used by the camera.

Network

- **Network Type**—Displays the type of network the camera is connected to.
- **IP Address**—Displays the IP address assigned to the camera.
- **Subnet Mask**—Displays the subnet mask assigned to the camera.
- **Gateway**—Displays the IP address of the gateway used by the camera.
- **Primary DNS**—Displays the IP address of the primary Domain Name Server used by the camera.
- **Secondary DNS**—Displays the IP address of the secondary Domain Name Server used by the camera.

Wireless



NOTE Wireless information is only found on the WVC2300 camera.

- **SSID**—Displays the wireless network name (SSID) used by the camera. The default is `ciscosb`.
- **Channel**—Displays the wireless channel used by the camera.
- **Security**—Indicates which wireless security is being used by the camera.

Status > Syslog & Log

The Status > Syslog & Log window has options for Log Type, Syslog Server, and Log List.

Log Type

Check the check box of the types of logs that you want to view on the Log List.

- System Log
- FTP Log
- SMTP Log
- IM Log

Syslog Server

- **Enable Syslog Server**—Check the check box to enable the Syslog server feature.
- **Syslog Server Address**—Enter the IP address of your Syslog server.
- **Syslog Port**—Enter the Syslog port number (between 1024 to 65535) in the field provided. The default syslog port is **514**.

Log List

- **Clear Log**—Click to erase all the entries in the System Log.

Status > Video Log

From the Status > Video Log window, you can erase a single entry or all entries in the video log.

Video Log

- This displays all video log(s). Click on each individual log to playback the video recorded when alerts were detected. Click **Delete** to either erase a single video log or erase all the entries in the Video Log.

Sample Configurations

The Cisco PVC2300 and WVC2300 Internet Video Cameras are capable of many functions. This chapter describes some sample configurations for your camera. The following sections are included:

- [Configuring Instant Recording, page 86](#)
- [Defining Preset Positions for Patrol Sequence, page 87](#)
- [Using Patrol Sequence, page 88](#)
- [Configuring E-Mail Alerts, page 89](#)
- [Scheduling an Event, page 91](#)
- [Configuring Motion Detection Area and Sensitivity, page 92](#)
- [Configuring Port Forwarding, page 94](#)
- [Setting Security Precautions on the Cisco WVC2300, page 97](#)

Configuring Instant Recording

To configure instant recording, follow these steps:

-
- STEP 1** From the Home window, click **Start Instant Recording** in the Video Options Icons. See [“Video Options Icons” on page 39](#).
 - STEP 2** Click **Save** in the dialog box if you agree with the default location \My Documents\Record. Otherwise, click **Browse** and choose another location.
 - STEP 3** Click the **Stop Instant Recording** to stop recording.
-

Defining Preset Positions for Patrol Sequence

**NOTE**

You can only use this feature if you have an external PTZ base that supports Pelco D Protocol.

To define preset positions for the camera patrol sequence, follow these steps:

- STEP 1** Click **Setup** in the toolbar.
 - STEP 2** Click **Applications > RS-485**. The Applications > RS-485 window displays.
 - STEP 3** To enable RS485, check the **Enable RS485** check box.
 - STEP 4** In Preset Position, click **Set Preset Position** to display the Set Pan/Tilt window.
 - STEP 5** In the Set Pan/Tilt window, configure the following:
 - **Set Home**—Set the desired position and then click **Set Home** to define the home position.
 - **Preset List**—Select the desired preset position and the screen will update with the current data for the selected preset. If you don't need the desired preset position, click **Remove**.
 - **Preset Name**—Enter a suitable name for the current desired position and then click **Add** button to add to the preset list.
 - **Pan Speed**—Select the desired speed for camera panning. Default value is 5.
 - **Tilt Speed**—Select the desired speed for camera tilting. Default value is 5.
 - STEP 6** Click **Save**. You are returned to the Applications > RS-485 window.
 - STEP 7** Your preset position is listed in the Patrol Sequence. Repeat the steps to define additional preset positions, if needed.
 - STEP 8** Click **Save**.
-

Using Patrol Sequence

Patrol sequence determines how the camera will move when it is set to rotate. You can set a number of preset positions. The camera will go to the first position, then move through the list of preset positions until it is finished. The camera will stop at the last position on the list.

To create the patrol sequence, follow these steps:

-
- STEP 1** Click **Setup** in the toolbar.
 - STEP 2** Click **Applications > RS-485**. The Applications > RS-485 window displays.
 - STEP 3** To enable RS485, check the **Enable RS485** check box.
 - STEP 4** In Patrol Sequence, select the desired Preset in the left column and click the **Add>>**. Repeat until the desired sequence is complete.

You can add the same preset position more than once to make the camera stay longer in one position.

- STEP 5** Click **Save**.
-

Configuring E-Mail Alerts

When using motion detection, you may want to be advised by e-mail when movement is detected. Configure your e-mail settings first and then configure scheduling an event. See [“Scheduling an Event” on page 91](#) and [“Configuring Motion Detection Area and Sensitivity” on page 92](#).

To configure e-mail alerts, follow these steps:

-
- STEP 1** Click **Setup** in the toolbar.
- STEP 2** Click **Applications > Mail**. The Applications > Mail window displays.
- STEP 3** In Primary SMTP, configure the following:
- Check the check box **Primary SMTP** to upload to the primary SMTP.
 - **SMTP Mail Server**—Enter the address of the Simple Mail Transport Protocol (SMTP) server to be used to send e-mail.
 - **Port**—Enter the port number of the mail server. The default is 25.
 - **Authentication**—From the drop-down list, choose one of the following options:
 - **Not Required**—Authentication is not required to send mail.
 - **Requires SMTP Authentication**—Select if the SMTP server requires a login to send mail.
 - **Requires POP before SMTP**—Select if the SMTP server requires a POP login to send mail.
 - **Account Name**—Enter the account name to be used on the e-mail server.
 - **Password**—Enter the password associated with the account name.
 - **POP Server Name**—Enter the name of the POP3 mail server that is being used to receive e-mail.
 - **Test SMTP Server**—Click to test the configuration. You will get an error message if the transaction does not complete, for example, test fails due to a wrong username or password.
 - **Requires SSL Encryption**—Check the check box to enable. This option supports cryptographic protocols that provide security and data integrity for communications over TCP/IP networks such as the Internet.

STEP 4 In **Secondary SMTP Server**, repeat the above steps if you are configuring a secondary SMTP server.



NOTE Only one SMTP server is used, even if both the primary and secondary SMTP servers are enabled. The secondary SMTP server is used if the camera cannot connect to the primary server.

STEP 5 In **E-mail Setup**, configure the following:

- **Send To**—Enter at least one e-mail address. The second and third addresses are optional. The e-mail alert is sent to the e-mail address or addresses specified here.
- **Show From as**—Enter the e-mail address to be shown in the From field when the e-mail is received.
- **Subject**—Enter the desired text to be shown as the subject for the e-mail when it is received.

STEP 6 Click **Save**.

Scheduling an Event

To schedule an event, follow these steps:

STEP 1 Click **Setup** in the toolbar.

STEP 2 Click **Applications > Event**. The Applications > Event window displays.

STEP 3 In Trigger Event, configure the following:

- **Enable**—Check the box to enable the configured trigger events.
- **Motion Detection**—Check the box so that movement in a motion detection window can be used to trigger events.
- **E-mail**—Check the check box, so that an e-mail will be delivered to the account configured in the Applications > Mail window when a trigger event occurs.

STEP 4 Click **Save**.

Configuring Motion Detection Area and Sensitivity

**NOTE**

Motion Detection cannot be configured using the Firefox browser. Internet Explorer must be used to configure motion detection.

To set the motion detection area of the video image to be examined and adjust the sensitivity of detection, follow these steps:

STEP 1 Click **Setup** in the toolbar.

STEP 2 Click **Applications > Motion Detection**. The Applications > Motion Detection window displays.

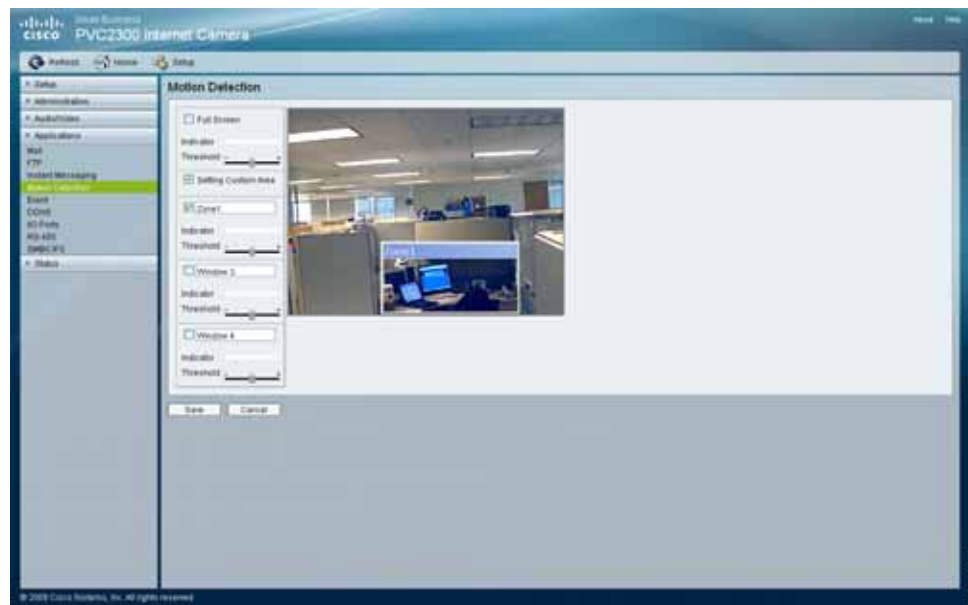

STEP 3 Check the check box for either Full Screen or Setting Custom Area:

- **Full Screen**—Detects motion events within the full view of the screen.
- **Setting Custom Area**—Captures motion within defined areas of the video screen. Multiple windows with varied threshold settings may be used.
 - **Window 2-4**—Enable one or more of these options to detect motion in specific areas of the video screen. Windows can be defined by simply extending the window with the cursor. More than one window can be used at once.

STEP 4 Use the **Threshold** slider to adjust the motion sensitivity. Less threshold means more sensitivity.

STEP 5 Click **Save**.

Configuring Port Forwarding

Port forwarding allows Internet access to multiple cameras that are located inside a private network. For example, you have two cameras behind a NAT router – one is on alternate port 1024 and the second one is on port 1028. To access each camera individually, setup two port forwarding rules to access the web interface of the camera. You can then go to `http://x.x.x.x:####/` where x.x.x.x is the WAN IP of the router and #### is the defined alternate port on the camera.

To set up port forwarding, follow these steps:

- STEP 1** From the camera's web-based utility, click **Setup > Advanced Setup**. The Advanced Setup window displays.
- STEP 2** Check the **Enable HTTP Alternative Port** check box and enter a port number in the HTTP Port field. In the example, port 1028 has been configured. Valid port settings are 1024-65535.

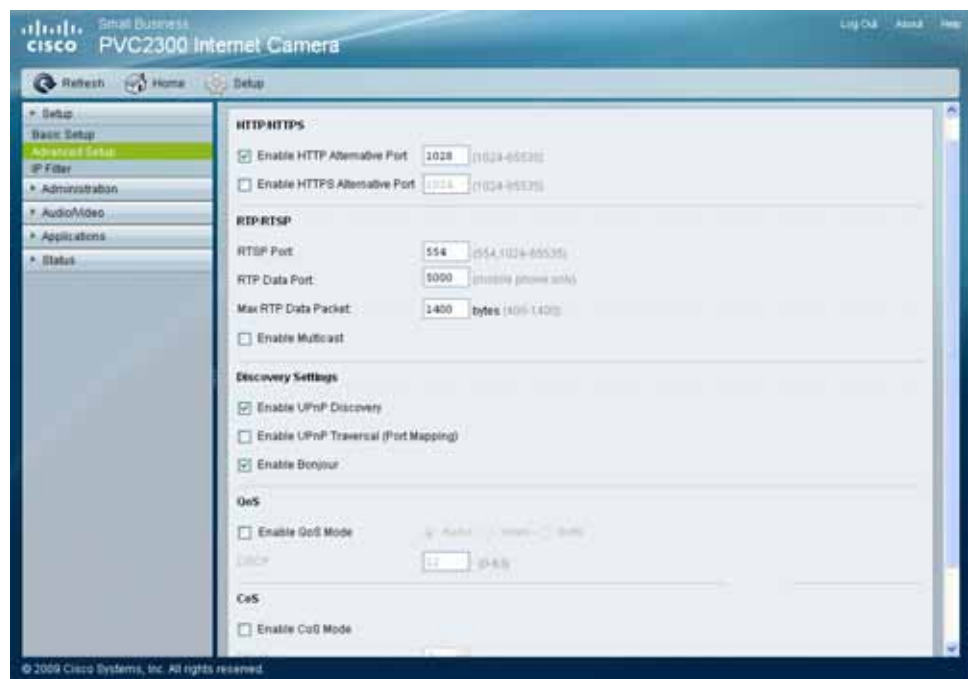

When you open the URL to the camera, you now must specify the port number. For example: `http://192.168.1.99:1028`

- STEP 3** Click **Save** and close the window.

- STEP 4** Enter the IP address of your router in your web browser's Address field and press **Enter**. For this example, we would use the default IP address of the router (**192.168.1.1**).
- STEP 5** From the web-based configuration utility, click **Firewall > Port Range Forwarding**. This example shows the Port Range Forwarding window of the Cisco WRVS4400N router.



- STEP 6** In the Port Range Forwarding window, configure the following:
- Enter the Application name, such as **Camera**.
 - Enter the Start and End port. In this example, **1028** is used and this should match the alternate HTTP port configured on the camera in [Step 2 on page 94](#).
 - Ensure that Protocol is set to **Both** (TCP and UDP).
 - Enter the IP address of the camera, in the IP Address field.
 - Check the **Enable** box to enable forwarding.
- STEP 7** Click **Save** to save the configuration to the router.
- STEP 8** Locate the WAN IP address for your router. Click **Setup > Summary** to view the WAN IP address of the router. The WAN IP address is displayed in the Network Status Setting section.

This example shows the Summary window of the Cisco WRVS4400N router.



Now you should be able to access your camera over the Internet by typing in the WAN IP address of your router, a colon, and the defined port number in the following format: `http://router's WAN IP address:port`

For example, `http://12.19.89.212:1028`

Setting Security Precautions on the Cisco WVC2300

The following is a complete list of security precautions to take (at least steps 1 through 4 should be followed):

**NOTE**

These steps apply to the Cisco WVC2300 camera.

- STEP 1** Change the default SSID from the **Setup > Basic** window in the **Wireless** settings. Change the SSID periodically.
- STEP 2** Disable SSID Broadcast on your access point or wireless router.
- STEP 3** Change the default password for the administrator account from the **Administration > Users** window.
- STEP 4** Use the highest encryption algorithm possible.
- Use WPA if it is available. From the **Setup > Basic** window, scroll to **Wireless** settings. Please note that this may reduce your network performance.
 - If using WEP, change the WEP encryption keys periodically. From the **Setup > Basic** window, scroll to **Wireless** settings.
-

**NOTE**

Some of these security features are available only through the network router or access point. Refer to the router or access point's documentation for more information.

Troubleshooting

Questions and Answers

This appendix provides solutions to problems that may occur during the installation and operation of the Cisco PVC2300 and WVC2300 Internet Video Cameras. Read the description below to solve your problems. If you can't find an answer here, see the Cisco web links in [Appendix D, "Where to Go From Here."](#)

**NOTE**

Microsoft Internet Explorer (IE) is the supported browser for the Cisco PVC2300 and WVC2300 cameras.

- Q. When I try to connect to the camera, I am prompted for a username and password.**

You should be prompted for a username and password when you first connect to the camera. Enter the username and password set in the Administration > Users window. The Username/Password prompt indicates that the administrator has restricted access to specified users. Ask the administrator for your username and password. If this has not been set, you can use the default username (**admin**) and the default password (**admin**).

- Q. I cannot connect to the WVC2300 Internet Camera using a wireless connection.**

You must perform the initial configuration of the WVC2300 camera from a personal computer connected to the camera using a wired connection to the Ethernet port. The initial configuration cannot be performed over a wireless connection.

Once the initial configuration is complete, disconnect the Ethernet cable. If an Ethernet cable is connected to the Ethernet port, the wireless interface is disabled. In order to switch from wired to wireless (or wireless to wired) the camera needs to be rebooted.

Also, check that your PC and the WVC2300 camera have compatible wireless settings.

- SSID must match.
- Wireless security settings must match.

Q. My video quality suddenly deteriorated.

This can happen when an additional viewer connects to the camera, overloading the camera or the available bandwidth. The image size and quality can be adjusted to cater for the required number of viewers and the available bandwidth.

Q. The motion detection feature doesn't send me any e-mails.

It may be that the SMTP (Simple Mail Transport Protocol) server used by the camera to send the e-mail will not accept mail. This is to prevent Spam being sent from the server. Try using a different SMTP server or contact your ISP to see if SMTP access is being blocked.

You must use a static IP address (you can copy the DHCP Address), but the DNS server must be that of the ISP and not of the router. You can find this address in the router's status log for WAN IP Address.



NOTE The secondary SMTP server is used if the camera cannot connect to the primary server. Only one SMTP server is used, even if both the primary and secondary SMTP servers are enabled.

Q. When using the motion detection feature, I receive e-mails that don't show any moving objects.

The motion detection feature doesn't actually detect motion. It compares frames to see if they are different. Major differences between frames are assumed to be caused by moving objects.

But the motion detector can also be triggered by sudden changes in the level of available light or movement of the camera. For example, twilight, dusk, and dawn, can cause false positive detections. Motion detection should not be used if the camera is outdoors because of the possibility of false positives. The motion detection feature works best in locations where there is good steady illumination and the camera is mounted securely.

Q. The video image is blurry.

Try cleaning the lens or adjusting the MPEG-4 or MJPEG image quality setting found in **"Audio/Video > Video"** on page 56.

Q. How do I set up UPnP so my cameras broadcast their availability to my network?

UPnP networking technology provides automatic IP configuration and dynamic discovery of devices added to a network. Services and capabilities offered by networking devices, such as printing and file sharing, are available among each other without a lot of network configuration.

UPnP is automatically enabled on the cameras. In a Windows environment, it may or may not be enabled. With Windows XP, you must log on to the computer as a system administrator to install the UPnP components. If using Windows Vista, UPnP is enabled by default. However, if it is not enabled, turn off UAC (User Access Control) before following this procedure.

Follow these steps to enable UPnP user interface on your computer:

STEP 1 Go to **Start**, click **Control Panel**, and then click **Add or Remove Programs**.

STEP 2 In the **Add or Remove Programs** dialog box, click **Add/Remove Windows Components**.



NOTE If the default ports are already used by another device connecting to the same router, the camera will select another port.

STEP 3 In the **Windows Components Wizard** dialog box, verify that **Networking Services** is checked.

STEP 4 Highlight **Networking Services** and click **Details**.

STEP 5 In the **Networking Services** dialog box, select **Universal Plug and Play** and click **OK**.

STEP 6 Click **Next** in the following window.

STEP 7 Click **Finish**. UPnP is enabled.

Windows Help

Almost all wireless products require Microsoft Windows. Windows is the most used operating system in the world and has many features that help make networking easier. These features can be accessed through Windows Help and are described in this appendix.

TCP/IP

Before a computer can communicate with an access point or router, TCP/IP must be enabled. TCP/IP is a set of instructions, or protocol, all PCs follow to communicate over a network. Your PCs will not be able to use networking without having TCP/IP enabled. Windows Help provides complete instructions for enabling TCP/IP.

Shared Resources

If you want to share printers, folders, or files over your network, Windows Help provides complete instructions about using shared resources.

Network Neighborhood/My Network Places

Other PCs on your network appear under Network Neighborhood or My Network Places (depending upon the version of Windows you're running). Windows Help provides complete instructions on adding PCs to your network.

WVC2300 Camera Bandwidth Test

This appendix details information from a Cisco WVC2300 Internet Video Camera bandwidth test. The test conditions are:

- Audio: On
- One user viewing video

Actual bandwidth will vary based on the image complexity. Number of colors, brightness, amount of motion, and other factors will determine the actual bandwidth. The values provided in the following table are provided for reference only.

Resolution	Quality	Frame Rate	Bandwidth (k/bps)	
			MPEG-4	MJPEG
640 x 480	Very High	30	2320	3040
		15	1840	2800
		6	880	1840
	Normal	30	2240	2800
		15	1680	2640
		6	640	1600
	Very Low	30	2160	2640
		15	1200	2400
		6	560	1200

Resolution	Quality	Frame Rate	Bandwidth (k/bps)	
320 x 240	Very High	30	1600	2000
		15	1200	1600
		6	600	800
	Normal	30	1440	1840
		15	800	1440
		6	360	640
	Very Low	30	760	1600
		15	480	1200
		6	200	480
160 x 120	Very High	30	1600	1440
		15	1120	800
		6	560	320
	Normal	30	560	1200
		15	320	640
		6	160	280
	Very Low	30	320	1040
		15	200	560
		6	120	240



Specifications

The Cisco PVC2300 and WVC2300 Internet Video Camera specifications are detailed in this appendix. Sections include:

- [PVC2300 Specifications, page 104](#)
- [WVC2300 Specifications, page 108](#)
- [I/O Port Specifications, page 111](#)

PVC2300 Specifications

Resource	Description
Model	PVC2300
Standards	IEEE802.3, IEEE802.3u, IEEE802.1p (QoS Priority), IEEE802.1q (VLAN)
Protocols Supported	TCP/IP, HTTP, DHCP, SMTP, FTP, NTP, DNS, UPnP, RTP, RTSP, and DDNS
Ports	Ethernet with POE, Microphone IN, Speaker OUT, Power (12V, 1A), GPIO, 4-pin IRIS port
Buttons	Reset
Cabling Type	UTP CAT 5
LEDs	Power, Network
Camera Type	Box
IO Ports	RS-485 x 1 (2 pins) Supports Pelco D Protocol commands: <ul style="list-style-type: none">▪ Input control x 2 (2 pins)▪ Output control x 2 (2 pins)

Specifications

PVC2300 Specifications



Resource	Description
Lens	
Sensor	1/4-inch Progressive CCD Sensor
Illumination	0.4LUX@F1.4
Lens Type	CS-mount lens, fixed focus. Adapter also included for lenses that require more distance between sensor and lens.
Focal Length	500mm~Infinity (for included lens)
Field of View	60° (for included lens)
Video Resolution	640x480 (VGA), 320x240 (QVGA), 160x120 (QQVGA)
Frame Rate	1 to 30 fps (selectable)
Iris	Provides DC-Iris control for CS-mount auto-iris lens when attached.
Setup/Config	
Web UI	Built in web UI for easy browser-based configuration (HTTP).
Management	
Web Browser	Internet Explorer 6.0 (or above) with ActiveX support for viewing, recording, playback, and setting motion detection; limited support for Safari and Mozilla Firefox (no motion detection).
Event Logging	Event Logging (SYSLOG)
Web F/W Upgrade	Firmware upgradable through web-browser.
Video Compression	
Dual Codec	MPEG-4 Simple Profile, MJPEG, Simultaneous dual-stream
Snapshot	JPEG
Image Settings	Brightness and Contrast
Zoom	4x Digital Zoom
Night Vision	IR filter switcher for low light.
Video Controls	Auto-White-Balance (AWB), Auto-Exposure (AES)
Image Control	Select video by Quality, Bandwidth, and Frame Rate.
Format	3GPP for use with 3G phones.

Specifications

PVC2300 Specifications



Resource	Description
Alerts	
Motion Detection	4 Detection areas with individual sensitivity
E-mail Alert	3 E-mail addresses
FTP Uploading	FTP server address and login settings.
Instant Messaging	Jabber client support
Scheduled	Schedule by day or time
Triggers	Inputs 1, Input 2, Motion Detection
Actions	Outputs 1, Output 2, Messaging, E-mail, FTP
Audio	
Summary	2-Way Audio
Built-in Microphone	6mm, -40db + 3db
Microphone Input	3.5 mm Phone jack
Speaker Output	3.5 mm Phone jack
Compression	G.726 - 16K, G.711 A-law and μ -law
Sampling Rate	8 KHz
Default Bit Rate	16 Kbps
Video Monitoring System	
Monitoring and Recording Software	<ul style="list-style-type: none">Monitoring and recording for up to 16 cameras.Advanced search histogram or by time and date.Recording set up to record by motion trigger, manual or schedule recording and playback.
Security	
User List	User rights list to view video and/or to camera control functions.
Username/ Password	Logon authentication 20 character username and 8 character password.
Kensington Lock	Physical security option

Specifications

PVC2300 Specifications



Resource	Description
Network	
RTP/RTSP	Real-Time Protocol, Real-Time Streaming Protocol allow for viewing from any client supporting these protocols, like 3G phones or Quicktime client.
NTP	Network Time Protocol keeps time of camera in sync with your network.
SMTP	Simple Mail Transfer Protocol Client allows video clips to be e-mailed.
FTP Client	FTP Client facilitates scheduling transfer of images to an FTP server.
DDNS	Dynamic DNS facilitates reaching the camera by a name irrespective of camera's IP address. Supports DynDNS, TZO, and 3322 Dynamic DNS.
Samba Client	Samba Client for recording files directly to a NAS device without having to leave a PC running.
UPnP	Allows autodiscovery of the camera by other UPnP devices.
IP Filtering	Allow or disallow access by IP address.
Power	
Power Options	IEEE 802.3af Power over Ethernet (PoE) — 48V/0.3A External Power Adaptor — 12V/1A, 110~120V AC/60Hz, Switching
Power Consumption	10W
Environmental	
Dimensions W x H x D	4.72 in. x 2.99 in. x 1.81 in. (120 mm x 76 mm x 46 mm)
Unit Weight	1.15 lb (0.52 kg)
Power	External power adapter 12 VDC 1A 110~120VAC/60Hz switching or POE 48V/0.3A
Certification	FCC part 15C class B, CE, UL, EMC/EMI part 15B class B for US
Operating Temperature	32 to 122°F (0 to 50°C)
Storage Temperature	-4 to 158°F (-20 to 70°C)
Operating Humidity	10% - 80%, Non-condensing
Storage Humidity	0% - 90%, Non-condensing

WVC2300 Specifications

Resource	Description
Model	WVC2300
Standards	IEEE802.11g, IEEE802.11b, IEEE802.3, IEEE802.3u, IEEE802.1p (QoS Priority), IEEE802.1q (VLAN), 802.11e (Wireless QoS)
Protocols Supported	TCP/IP, HTTP, DHCP, SMTP, FTP, NTP, DNS, UPnP, RTP, RTSP and DDNS
Ports	Ethernet, Microphone IN, Speaker OUT, Power (12V, 1A), GPIO, 4-pin IRIS port
Buttons	Reset
Cabling Type	UTP CAT 5
LEDs	Power, Network
Camera Type	Box
IO Ports	RS-485 x 1 (2 pins) - Supports Pelco D Protocol commands: <ul style="list-style-type: none"> ▪ Input control x 2 (2 pins) ▪ Output control x 2 (2 pins)
Lens	
Sensor	1/4-inch Progressive CCD Sensor
Illumination	0.4LUX@F1.4
Lens Type	CS-mount lens, fixed focus. Adapter also included for lenses that require more distance between sensor and lens.
Focal Length	500mm~Infinity (for included lens)
Field of View	60° (for included lens)
Video Resolution	640x48 (VGA), 320x240 (QVGA), 160x120 (QQVGA)
Frame Rate	1 to 30 fps (selectable)
Iris	Provides DC-Iris control for CS-mount auto-iris lens when attached.
Setup/Config	
Web UI	Built in web UI for easy browser-based configuration (HTTP).

Resource	Description
Management	
Web Browser	Internet Explorer 6.0 (or above) with ActiveX support for viewing, recording, playback, and setting motion detection; limited support for Safari and Mozilla Firefox (no motion detection).
Event Logging	Event Logging (SYSLOG)
Web F/W Upgrade	Firmware upgradable through web-browser.
Video Compression	
Dual Codec	MPEG-4 Simple Profile MJPEG Simultaneous dual-stream
Snapshot	JPEG
Image Settings	Brightness and Contrast
Zoom	4x Digital Zoom
Night Vision	IR cut filter for low light.
Video Controls	Auto-White-Balance (AWB), Auto-Exposure (AES)
Image Control	Select video by Quality, Bandwidth, and Frame Rate.
Format	3GPP for use with 3G phones.
Alerts	
Motion Detection	4 Detection areas with individual sensitivity
E-mail Alert	3 E-mail addresses
FTP Uploading	FTP server address and login settings.
Instant Messaging	Jabber client support
Scheduled	Schedule by day or time.
Triggers	Inputs 1, Input 2, Motion Detection
Actions	Outputs 1, Output 2, Messaging, E-mail, FTP
Audio	
Summary	2-Way Audio
Built-in Microphone	6mm, -40db + 3db
Microphone Input	3.5 mm Phone jack

Specifications

WVC2300 Specifications



Resource	Description
Speaker Output	3.5 mm Phone jack
Compression	G.726 - 16K, G.711 A-law and μ -law
Sampling Rate	8 KHz
Default Bit Rate	16 Kbps
Video Monitoring System	
Monitoring and Recording Software	<ul style="list-style-type: none">Monitoring and recording for up to 16 cameras.Advanced search histogram or by time and date.Recording set up to record by motion trigger, manual or schedule recording and playback.
Security	
WEP/WPA	WEP 64bit/128bit, WPA-TKIP, WPA-PSK
User List	User rights list to view video and/or to camera control functions.
Username/ Password	Logon authentication 20 character username and 8 character password.
Kensington Lock	Physical security option
Network	
RTP/RTSP	Real-Time Protocol, Real-Time Streaming Protocol allow for viewing from any client supporting these protocols, like 3G phones or Quicktime client.
NTP	Network Time Protocol keeps time of camera in sync with your network.
SMTP	Simple Mail Transfer Protocol Client allows video clips to be e-mailed.
FTP Client	FTP Client facilitates scheduling transfer of images to an FTP server.
DDNS	Dynamic DNS facilitates reaching the camera by a name irrespective of camera's IP address. Supports DynDNS, TZO, and 3322 Dynamic DNS services. Supports Samba Client for recording files directly to a NAS device without having a computer powered on.
UPnP	Allows autodiscovery of the camera by other UPnP devices.
IP Filtering	Allow or disallow access by IP address.
Power	
Power Options	External Power Adapter: 12V/1A, 110~120V AC/60Hz, Switching

Specifications

I/O Port Specifications

C

Resource	Description
Power Consumption	10W
Environmental	
Dimensions W x H x D	4.72 in. x 2.99 in. x 1.81 in. (120 mm x 76 mm x 46 mm)
Unit Weight	1.15 lb (0.52 kg)
Power	External power adapter 12 VDC 1A 110~120VAC/60Hz switching
Certification	FCC part 15C class B, CE, UL, EMC/EMI part 15B class B for US
Operating Temp.	32 to 122°F (0 to 50°C)
Storage Temp.	-4 to 158°F (-20 to 70°C)
Operating Humidity	10% - 80%, Non-condensing
Storage Humidity	0% - 90%, Non-condensing

I/O Port Specifications

The following diagram illustrates the I/O pin specifications for the PVC2300 and WVC2300 cameras.

I/O Pin Specifications

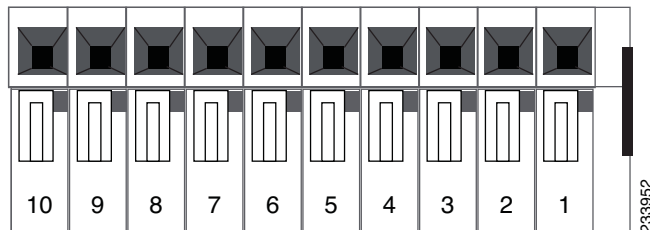

The following table provides function and description detail for the I/O pins for the PVC2300 and WVC2300 cameras.

PIN	Function	Description
1	12VDC Output	With a maximum load of 100mA, this output to be used with an external device.
2	GND	
3	Digital Input 1	Connect to high to activate (5V-12V)
4	Digital Output 1	With a maximum load of 100mA and maximum voltage of 12VDC, this output has an open-collector NPN transistor with the emitter connected to GND.
5	Digital Input 2	Connect to high to activate (5V-12V)
6	Digital Output 2	With a maximum load of 100mA and maximum voltage of 12VDC, this output has an open-collector NPN transistor with the emitter connected to GND.
7	GND	
8	12VDC Output	With a maximum load of 100mA, this output to be used with an external device.
9	RS485-B (Inverting)	A-half duplex RS485 interface for controlling auxiliary equipment
10	RS485-A (non-Inverting)	



WARNING Risk is involved if connecting more than 100mA

Wiring Diagram to Connect PIR Motion Sensor and Alarm to the I/O Ports

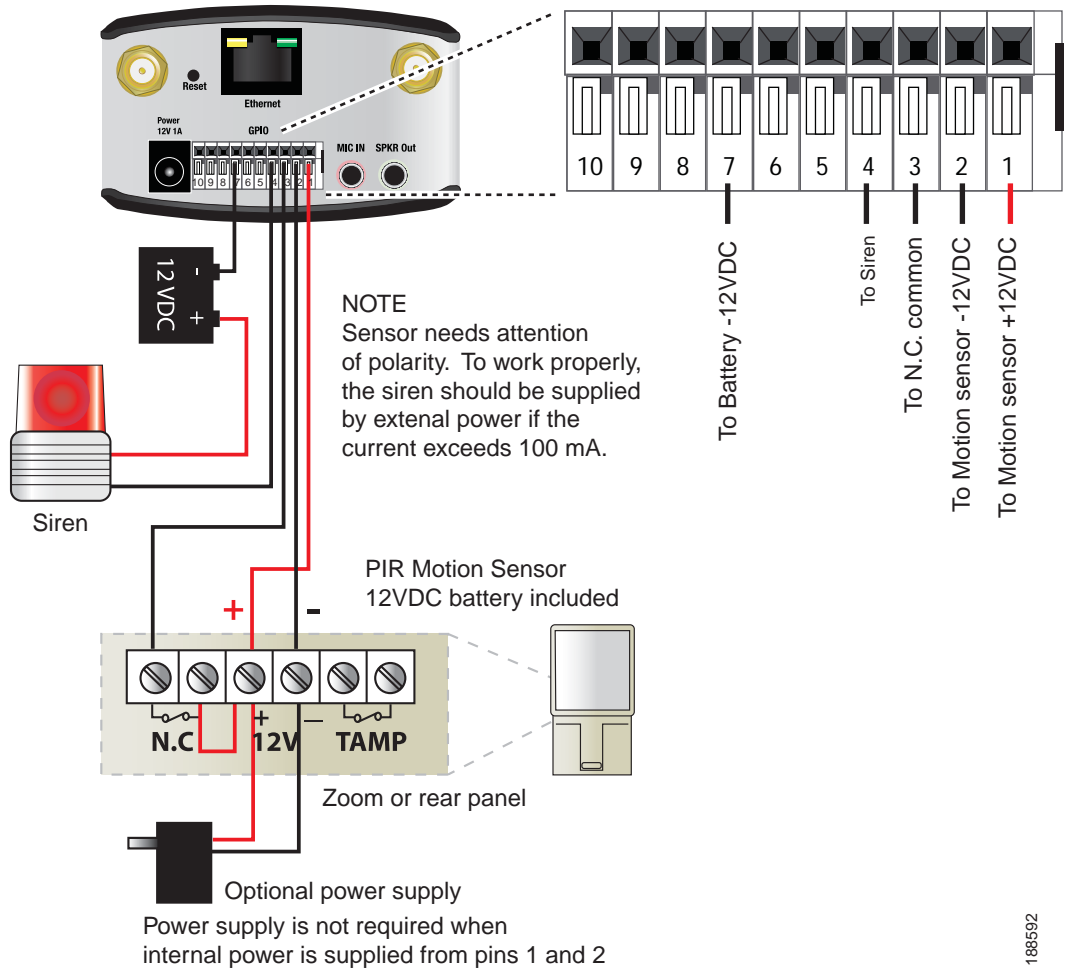

188592



NOTE You can manually turn on or off the output ports using the video options icons in the camera's Home window. See ["Video Options Icons" on page 39.](#)

Where to Go From Here

Cisco provides a wide range of resources to help you and your customer obtain the full benefits of the Cisco PVC2300 and WVC2300 Internet Video Cameras.

Product Resources

Support	
Cisco Small Business Support Community	www.cisco.com/go/smallbizsupport
Online Technical Support and Documentation (Login Required)	www.cisco.com/support
Phone Support Contacts	www.cisco.com/en/US/support/tsd_cisco_small_business_support_center_contacts.html
Software Downloads (Login Required)	Go to tools.cisco.com/support/downloads , and enter the model number in the Software Search box.
Product Documentation	
Cisco Small Business PVC2300 and WVC2300 Internet Video Camera with Audio Quick Start Guide	http://www.cisco.com/en/US/products/ps9944/prod_installation_guides_list.html
Cisco Small Business PVC2300 and WVC2300 Internet Video Camera with Audio Administration Guide	http://www.cisco.com/en/US/products/ps9944/prod_maintenance_guides_list.html

Regulatory Compliance and Safety Information for the Wired and Wireless Internet Cameras	http://www.cisco.com/en/US/products/ps9944/prod_installation_guides_list.html
Cisco Small Business	
Cisco Partner Central for Small Business (Partner Login Required)	www.cisco.com/web/partners/sell/smb
Cisco Small Business Home	www.cisco.com/smb
Marketplace	www.cisco.com/go/marketplace