



Series 988

User's Manual

Includes 986, 987, 988 and 989



1/8 DIN Microprocessor-Based Temperature/Process Controller

User Levels:

- New User..... go to Introduction
- Experienced User..... go to page 4.1

Installers:

- Set-up..... go to page 1.1
- Wiring & Installation..... go to page 2.1

CE 96

**TOTAL
CUSTOMER
SATISFACTION**

3 Year Warranty

ISO 9001



Registered Company
Winona, Minnesota USA



Watlow Controls

1241 Bundy Blvd., P.O. Box 5580, Winona, Minnesota USA 55987-5580
Phone: (507) 454-5300, Fax: (507) 452-4507 <http://www.watlow.com>

0600-0009-0001 Rev W

March 1999

Supersedes: 0600-0009-0001 Rev V

\$10.00

Made in the U.S.A.

Printed on Recycled Paper 10% Postconsumer Waste

Introduction to the Watlow Series 988 Controllers

- ii Using this Manual
- ii Document Every Step
- iii Notes, Cautions and Warnings
- iii Technical Assistance
- iii We Value Your Feedback

Chapter 1 Hardware Setup

- 1.1 Dip Switch Locations and Functions

Chapter 2 Installation and Wiring

- 2.1 Panel Cutout and Dimensions
- 2.2 Installing the Series 988
- 2.4 Wiring the Series 988
- 2.4 Input-to-output Isolation
- 2.4 Power Wiring
- 2.5 Sensor Installation Guidelines
- 2.6 Wiring Example
- 2.8 Input 1 Wiring
- 2.9 Input 2 Wiring
- 2.11 Event Input 1 Wiring
- 2.12 Output 1 Wiring
- 2.13 Output 2 Wiring
- 2.14 Output 3 Wiring
- 2.15 Output 4 Wiring

Chapter 3 Front Panel and Display Loop

- 3.1 Keys and Displays
- 3.2 Display Loop

Chapter 4 The Setup Menus

- 4.1 Navigating the Setup Menus
- 4.2 Input Menu
- 4.18 Output Menu
- 4.34 Global Menu
- 4.44 Communications Menu

Chapter 5 The Operation Menus

- 5.1 Navigating the Operation Menus
- 5.2 System Menu
- 5.9 PID A and PID B Menus

Chapter 6 The Factory Menus

- 6.1 Navigating the Factory Menus
- 6.2 Panel Lockout Menu
- 6.7 Diagnostics Menu
- 6.13 Calibration Menu

Chapter 7 Tuning, Manual Operation, Alarms and Error Codes

- 7.1 Auto-tuning (Heat and/or Cool)
- 7.2 Manual Tuning
- 7.4 Manual and Automatic Operation
- 7.5 Changing the Output 3 Alarm Jumper
- 7.6 Using Alarms
- 7.8 Error Code E1 and E2 Messages
- 7.9 Error Code Actions

Chapter 8 General Software

- 8.2 Burst Fire
- 8.4 Communications
- 8.6 Dead Band
- 8.8 Digital Events
- 8.10 Heater Current
- 8.12 Input Filter
- 8.14 Input Linearization
- 8.16 Ramp to Set Point
- 8.18 Remote Set Point
- 8.20 Retransmit
- 8.22 Slidewire Feedback

Appendix

- A.2 Glossary
- A.4 Specifications
- A.5 Warranty and Returns
- A.6 Index
- A.10 Menu Overview
- A.11 Model Number – Ordering Information
- A.12 Declaration of Conformity

Introduction to the Watlow Series 988 Controllers



**Figure Int.1 -
The Series 988
Controllers.**

Watlow's Series 988 controllers set a new standard in the controller industry by packing an impressive array of features into an 1/8-DIN package. No other controller offers the flexibility, compact size and durability of the Series 988. It can control a wide variety of temperature and process applications, with a broad range of input and output options that allow control of virtually any process variable.

The Series 988 is the only 1/8 DIN controller that can provide single-unit cascade control of a process. Its other features include heater current monitoring, remote set point input, ratio control and valve control through slidewire feedback. The Series 988 also delivers expanded auto-tuning capabilities, increased alarm functionality and several unique control algorithms.

When we refer to the "Series 988" controller, we refer also to the horizontal and low-voltage versions of the Series 988: the 986, 987, 988 and 989. We recommend that you read all of this manual's introduction to familiarize yourself with the conventions and content of this manual and the steps to setting up a Series 988 controller. Make sure you understand the "Caution" and "Warning" symbols we use in the book.

Using this Manual

This manual provides the information you will need to install and operate a Series 988 controller.

If you need information about Series 988 configurations and model numbers, refer to the Appendix of this manual or, for more detailed information, to *Optimizing Your Process System with the Series 988 Controller: An Application Guide for the Watlow Series 988 Family*.

If your Series 988 controller will be used for data communications, you will also need our communications manual, *Data Communications with the Watlow Series 988 Family of Controllers* (green cover).

Series 988 controllers are calibrated in the factory, but if you need to do periodic calibration you will need our calibration manual, *Calibrating Watlow Process Controllers*, (blue cover).

This manual explains the five steps of setting up a Series 988 controller:

1. Set and document all of the DIP switches, if applicable: Chapter 1.
2. Mount the controller: Chapter 2.
3. Wire and document the controller wiring: Chapter 2.
4. Configure and document the controller software: Chapters 3-6.
5. Run, test and adjust your application. Update documentation.

Chapters 7 and 8 and the Appendix provide detailed advice, definitions and specifications along with application examples to help you optimize the safety and performance of your application. Use the Table of Contents and Index to find specific information.

Document Every Step

The Series 988 provides powerful and complex features. Carefully document each step of the setup and any subsequent changes. This will make it much easier to change, adjust and troubleshoot your application.

Make the configuration documentation available to engineers and technicians, on all shifts, who may need to work with the Series 988. We provide space in this manual to record configurations. You may prefer to photocopy the blank forms and keep them in a separate binder. However you maintain your documentation, be sure to replace all old copies of the documentation with updated versions whenever the controller configuration is changed.

NOTE:
The 12-digit number is printed on the top of the stickers on each side of the controller's case and on the right-hand or top circuit board.

NOTE:
The Menu Overview in the Appendix shows all the menus and prompts.

Notes, Cautions and Warnings

We use note, caution and warning symbols throughout this book to draw your attention to important operational and safety information.

A bold text “**NOTE**” marks a short message in the margin to alert you to an important detail.

A bold text “**CAUTION**” safety alert appears with information that is important for protecting your equipment and performance. **Be especially careful to read and follow all cautions that apply to your application.**

A bold text “**WARNING**” safety alert appears with information that is important for protecting you, others and equipment from damage. **Pay very close attention to all warnings that apply to your application.**

The  symbol (an exclamation point in a triangle) precedes a general CAUTION or WARNING statement.

The  symbol (a lightning bolt in a triangle) precedes an electric shock hazard CAUTION or WARNING safety statement.

Technical Assistance

If you encounter a problem with your Watlow controller, review all of your configuration information for each step of the setup to verify that your selections are consistent with your applications.

If the problem persists after checking all the steps, you can get technical assistance by calling Watlow Controls at (507) 454-5300, between 7 a.m. and 5 p.m. CST, and asking for an applications engineer. When you call have the following information on hand: the controller’s model number (the 12-digit number is printed on the top of the stickers on each side of the controller’s case and on the right-hand or top circuit board); your user’s manual; all configuration information; and the Diagnostics Menu readings.

We Value Your Feedback

Your comments and suggestions on this manual are welcome. Please send them to, Technical Writer, Watlow Controls, 1241 Bundy Blvd., P.O. Box 5580, Winona, MN 55987-5580 or call (507) 454-5300 or fax (507) 452-4507. The Series 988 User’s Manual is copyrighted by Watlow Winona, Inc., © March 1999, with all rights reserved. (1657)

Chapter 1 Hardware Setup

DIP Switch Locations and Functions

The Watlow Series 988 has at least one and as many as six dual in-line package (DIP) switches inside the controller, depending on the model number. They allow users to configure the controller for a variety of input sensors, to provide power for external signal conditioners or to lockout front panel access to some functions.

To set any DIP switch:

- Remove the controller from the case by pressing firmly on the two release tabs on one side or the top of the bezel until they unsnap. Then firmly press the two release tabs on the opposite side or the bottom of the control until they unsnap. You will need to gently rock the bezel back and forth to release it from the chassis.
- Use the illustrations on the following pages to locate and set each DIP switch.

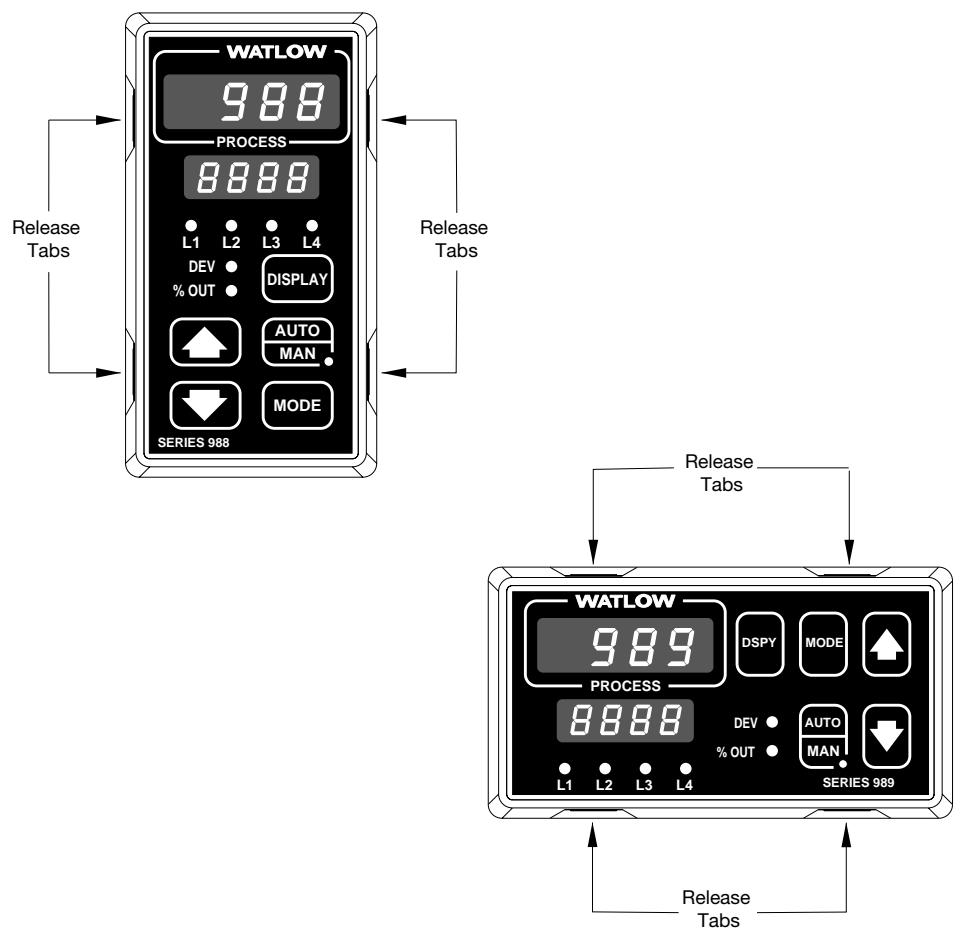
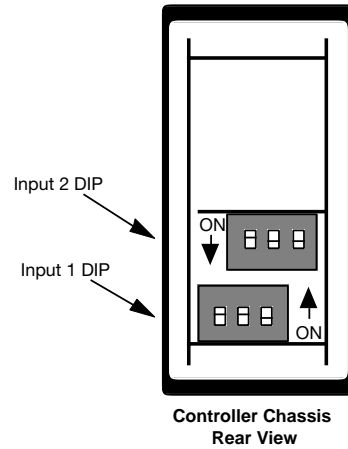

Figure 1.1 - Press the release tabs to remove the controller chassis.

DIP Switches

1. Set the input DIP switches to match the sensors you are using in your application. Only controllers with model number 98__-2____-____ or 98__-__2____-____ have an input DIP switch.

NOTE:
The Input 2 DIP switch is mounted upside down.



NOTE:
Only controllers with the indicated model numbers have these DIP switches.

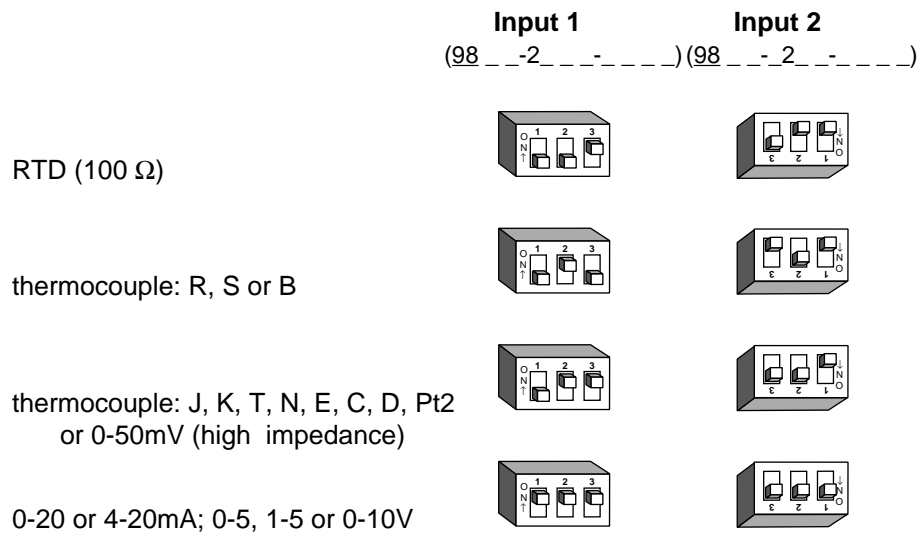
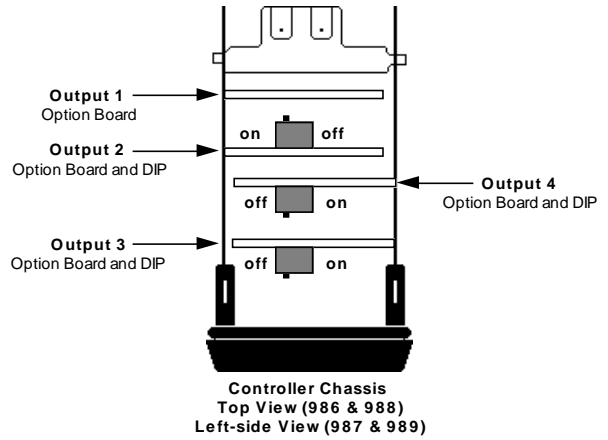

Figure 1.2 -
Input DIP switches.

DIP Switches

2. Set DIP switches for outputs equipped with an external signal conditioner power supply. Only controllers with model number 98__-__T-____, 98__-__T-____ or 98__-__T-____ have an external signal conditioner power supply.

NOTE:
For other voltages or current settings contact the factory.



NOTE:
Only controllers with the indicated model numbers have these DIP switches.

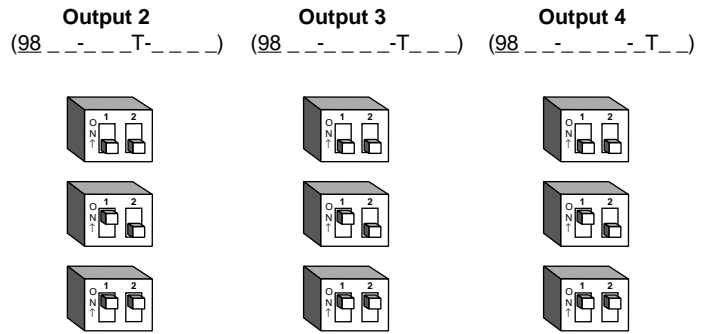

Figure 1.3 - External signal conditioner power supply DIPs.

3. When the DIP switches are set, gently insert the controller chassis into the case and push it firmly into place until all four tabs snap into place.

DIP Switches



CAUTION:
 The lockout DIP switch makes the Setup and Factory menus unavailable. Configure all the Setup and Factory menus before locking them out. Failure to do so could result in damage to equipment in the event of a setup error.

- The lockout DIP switch hides the Setup Menu (Input, Output, Global and Communications) and the Factory Menu (Panel Lockout, Diagnostics and Calibration). All units have a lockout DIP switch.

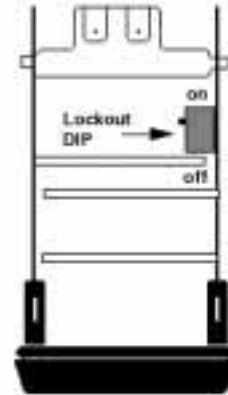

Control Chassis
 Top View (986 & 988)
 Left-side View (987 & 989)

no hardware lockout
 (Switch 1 has no effect.)

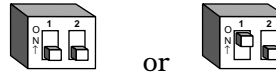

lockout Setup and Factory menus
 (Switch 1 has no effect.)

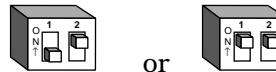
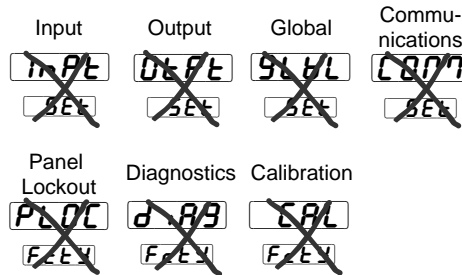
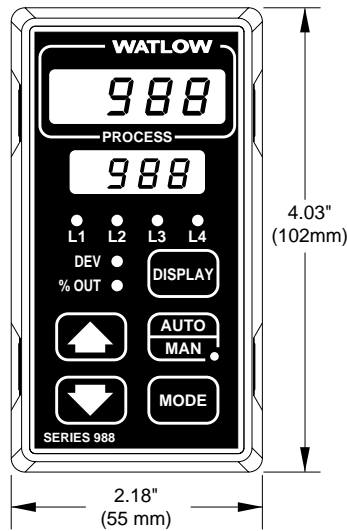

Figure 1.4 - Lockout DIP switch.



Chapter 2 Installation and Wiring

NOTE:
Space panel cutouts at least 1.66 inches (42.2mm) apart.



NOTE:
Adjustable mounting brackets can be side-mounted.

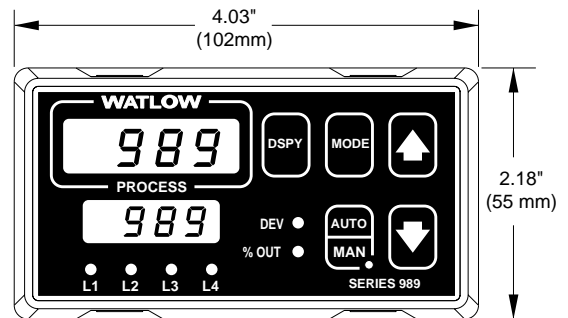

NOTE:
Holes can be cut in the panel using a Greenlee 1/8 DIN Hydraulic Kit #60068 (punch #60069, die #60070).

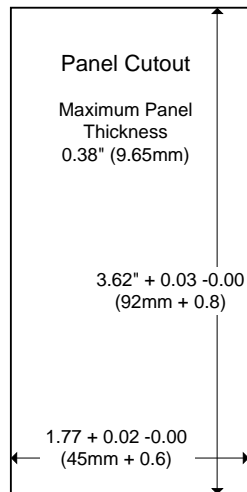
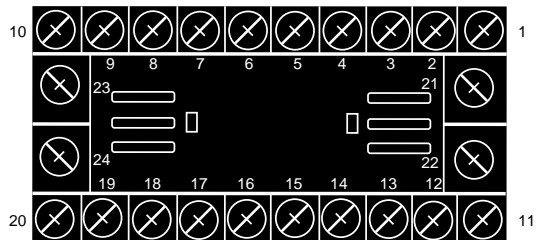
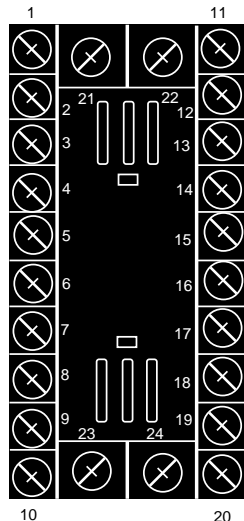
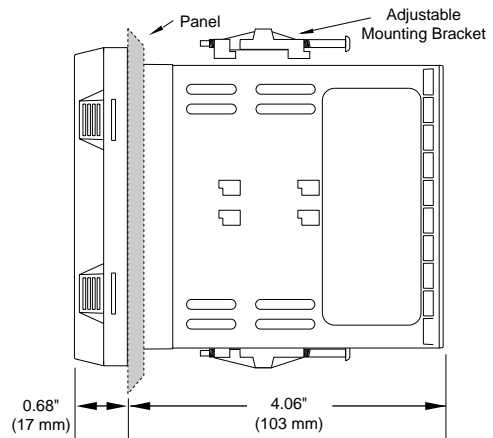

Figure 2.1 - Series 988 and Series 989 dimensions and terminal number layout.



Installing the Series 988

Installing and mounting requires access to the back of the panel.

1. Make a panel cutout using the panel cutout dimensions from the previous page.
2. To remove the controller chassis from its case, press in firmly on the two tabs on one side or the top of the bezel until they unsnap, then unsnap the two tabs on the opposite side or the bottom. Pull the chassis out of the case by gently rocking it.
3. Slide the case into the panel cutout. Check to see that the gasket is not twisted, and is seated within the case bezel flush with the panel. Slide

NOTE:
Removing the controller chassis from its case makes mounting easier.

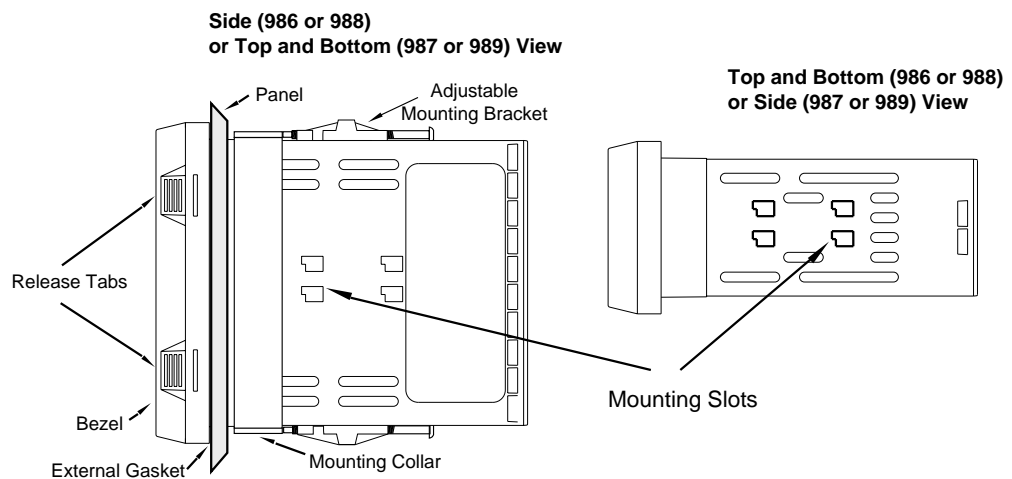

Figure 2.2 -
Side and top view.

the mounting collar over the back of the control.

4. Loosen the mounting bracket screws enough to allow for the mounting collar and panel thickness. Place each mounting bracket into the mounting slots (head of the screw facing the back of the controller). Push each bracket backward then down to secure it to the control case. **To guarantee a proper NEMA 4X seal, Series 986 and 988 units (vertical) must have the mounting brackets located on either side of the unit. When installing Series 987 and 989 units (horizontal) the brackets must be on the top and bottom of the unit.**
5. Make sure the case is seated properly. Tighten the installation screws firmly against the mounting collar to secure the unit. **To ensure a NEMA 4X seal, there should be no space between the bezel and panel.** Overtightening the screws will distort the case and make it difficult to remove or replace the controller.
6. Make sure the inside gasket is seated properly and not twisted. Insert the controller chassis into its case and press the bezel until all four tabs snap.
7. To release the mounting brackets, loosen the mounting bracket screws and push the brackets forward, then pull it up and out.



CAUTION:
Follow the installation procedure exactly to guarantee a proper NEMA 4X seal. Make sure the gasket between the panel and the rim of the case is not twisted and is seated properly. Failure to do so could result in damage to equipment.

Wiring



WARNING:
To avoid potential electric shock, use National Electric Code (NEC) safety practices when wiring and connecting this unit to a power source and to electrical sensors or peripheral devices. Failure to do so could result in injury or death.

NOTE:
Input-to-output isolation is defeated when the external signal conditioner power supply is used to power a transmitter connected to input 1 or input 2.

Figure 2.4 - Power wiring.

Wiring the Series 988

Wiring options depend on the model number and DIP switch settings. Check the terminal designation stickers on either side of the controller and compare your model number to those shown here and with the model number breakdown on the inside back cover of this manual.

Input-to-output Isolation

The Series 988 uses optical isolation between the analog inputs and the controller outputs/digital input. This isolation provides a 500V~ (ac) barrier to prevent ground loops when using grounded sensors and/or peripheral equipment.

Here is a breakdown of the isolation barriers:

- Analog inputs 1 and 2 are grouped together.
- Outputs 1 through 4 and the standard event input are grouped together. This does not apply to Output 4 when configured as communications.
- The digital communications output (4) is separate from the above groups.

Power Wiring

100 to 240V \approx (ac/dc) nominal, (85 to 264 actual)

Vertical Package	98 8 _ - _ _ _ _ - _ _ _ _
Horizontal Package	98 9 _ - _ _ _ _ - _ _ _ _

24 to 28 V \approx (ac/dc) nominal, (20 to 30 actual)

Vertical Package	98 6 _ - _ _ _ _ - _ _ _ _
Horizontal Package	98 7 _ - _ _ _ _ - _ _ _ _

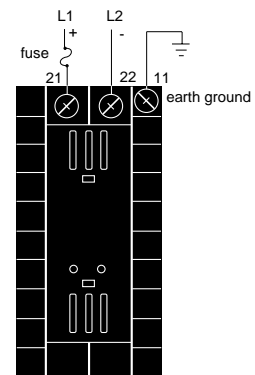

Sensor Installation Guidelines

**CAUTION:**

The Series 988 will not function with two grounded thermocouple inputs. Avoid using a grounded thermocouple for both input 1 and input 2. Failure to follow this guideline could result in damage to equipment.

NOTE:

Input-to-output isolation is defeated when the external signal conditioner power supply is used to power a transmitter connected to input 1 or input 2.

Maintain isolation between input 1 and input 2 to prevent a ground loop. A ground loop may cause incorrect readings, dashes across the upper display or the display of error codes.

Thermocouple input: Extension wire for thermocouples must be of the same alloy as the thermocouple itself to limit errors.

Using grounded thermocouples for both input 1 and input 2 may create ground loop problems. To correct this problem, replace at least one of the grounded thermocouples with an ungrounded thermocouple. If the application requires grounded thermocouples, use an isolated transmitter, such as a Watlow Gordon 5702 isolated transmitter.

RTD (100 Ω) input: Each 1 Ω of lead wire resistance can cause a +2 $^{\circ}$ C error when using a two-wire RTD. A three-wire RTD sensor overcomes this problem. All three wires must have the same electrical resistance (i.e., same gauge, same length, multi-stranded or solid, same metal).

Process input: Isolation must be maintained between input 1 and input 2. If both input 1 and input 2 are used as process inputs, a separate power supply and transmitter must be used for each input. Output option T (external signal conditioner power supply) can be used to supply power for only one input.

Wiring Example



WARNING:
To avoid potential electric shock, use National Electric Code (NEC) safety practices when wiring and connecting this unit to a power source and to electrical sensors or peripheral devices. Failure to do so could result in injury or death.



WARNING:
Install high or low temperature limit control protection in systems where an over temperature fault condition could present a fire hazard or other hazard. Failure to install temperature limit control protection where a potential hazard exists could result in damage to equipment, property and injury to personnel.



WARNING:
To avoid damage to property and equipment, and/or injury of loss of life, use National Electric Code (NEC) standard wiring practices to install and operate the Series 988. Failure to do so could result in such damage, and/or injury or death.

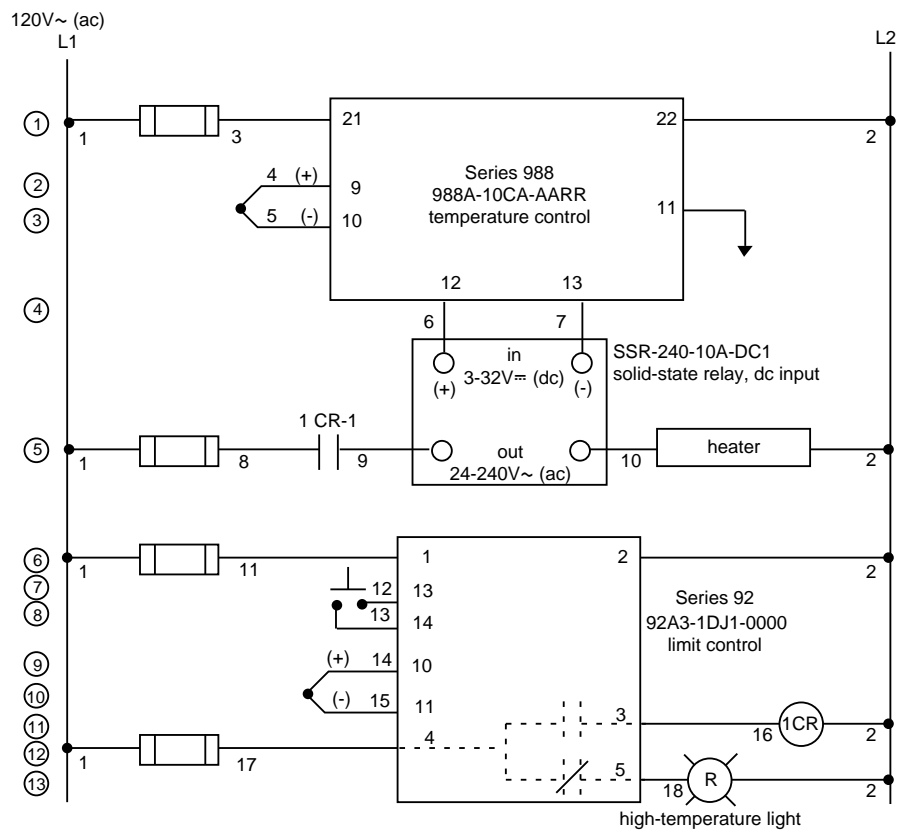
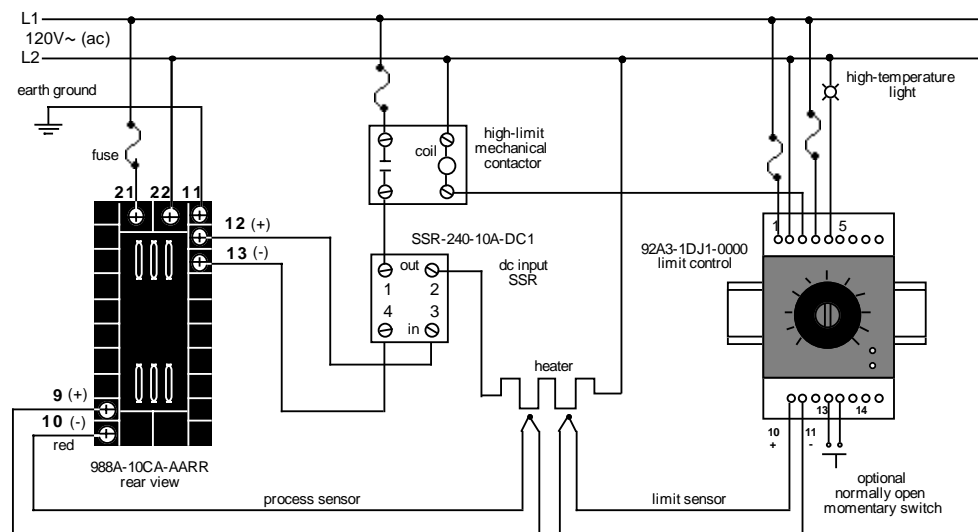

Figure 2.6 -
System wiring
example.



WARNING:
To avoid damage to property and equipment, and/or injury or loss of life, use National Electric Code (NEC) standard wiring practices to install and operate the Series 988. Failure to do so could result in such damage, and/or injury or death.

NOTE:
Sketch in your application on this page or a copy of it. See wiring examples in this chapter and in the Appendix.

Figure 2.7 -
Wiring notes.

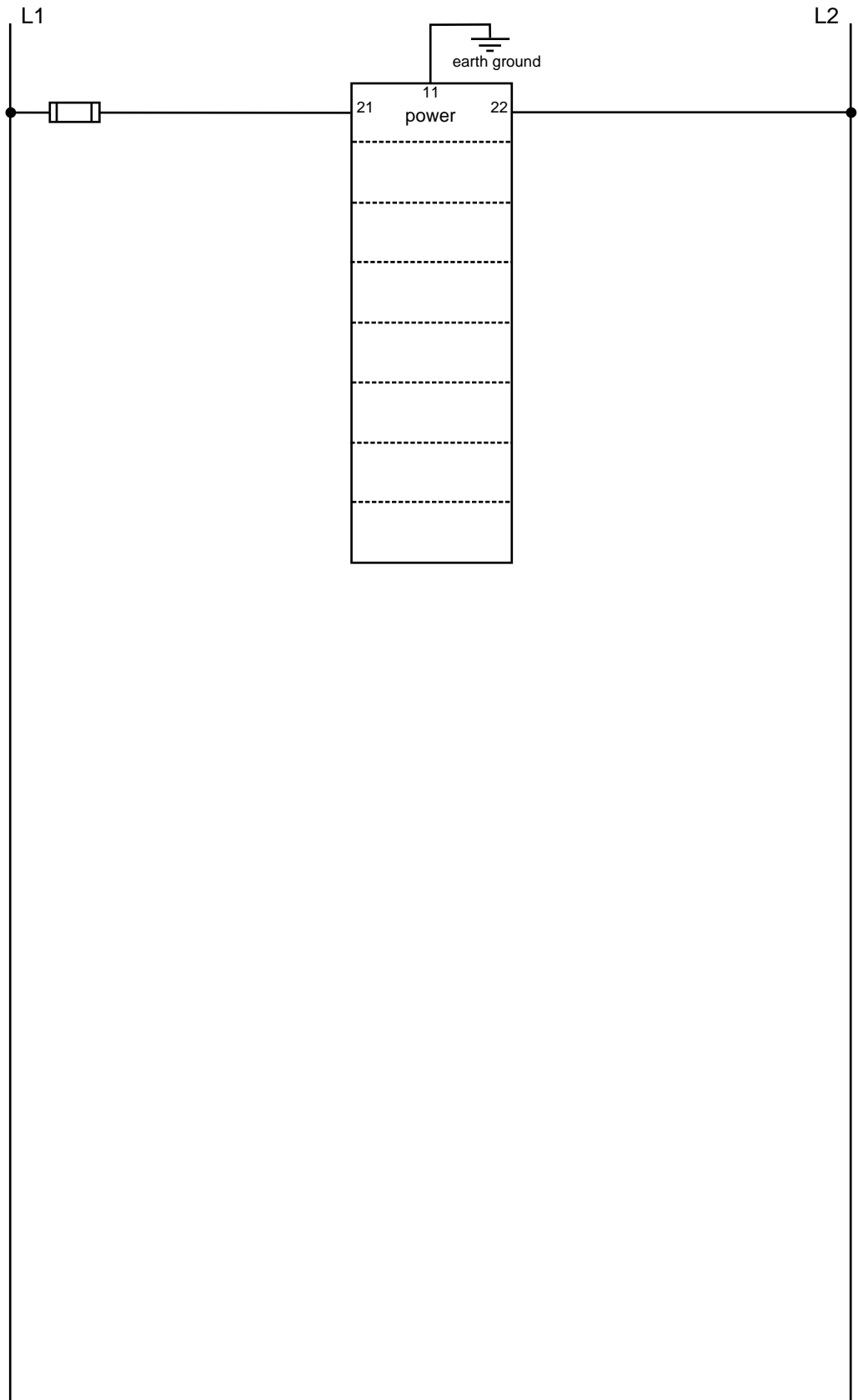

Input 1 Wiring

NOTE:

Successful installation requires five steps:

- Model number and software choice (Appendix);
- DIP switch settings (Chapter 1);
- Sensor match (Chapter 2 and Appendix);
- Sensor installation (Chapter 2); and
- Wiring (Chapter 2).

Figure 2.8a — Thermocouple or 0-50mV (high impedance)

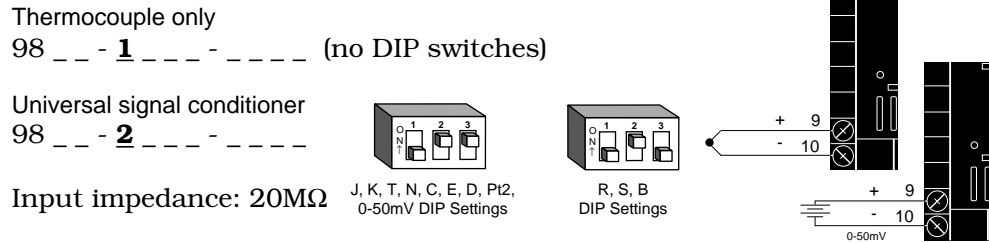

Figure 2.8b — RTD (2- or 3-wire) (100 Ω)

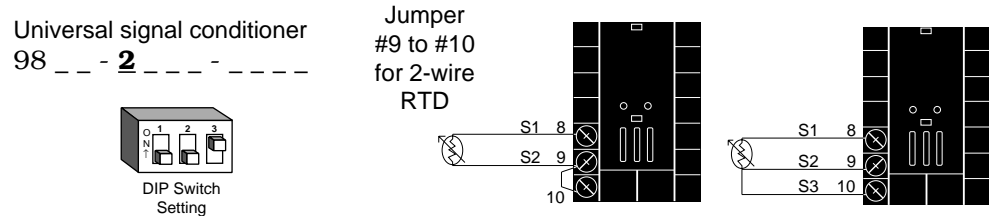

Figure 2.8c — 0-5V_{DC}, 1-5V_{DC} or 0-10V_{DC} Process

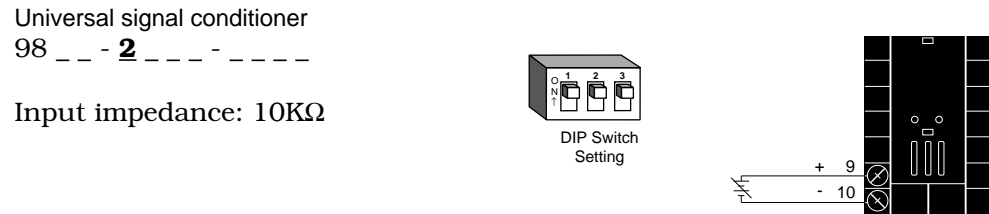
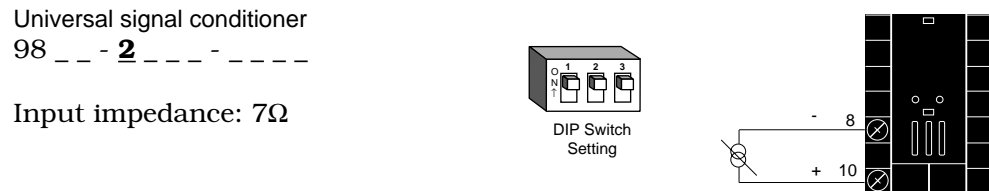

Figure 2.8d — 0-20mA or 4-20mA Process



NOTE:

Successful installation requires five steps:

- Model number and software choice (Appendix);
- DIP switch settings (Chapter 1);
- Sensor match (Chapter 2 and Appendix);
- Sensor installation (Chapter 2); and
- Wiring (Chapter 2).

Figure 2.9a — Thermocouple or 0-50mV (high impedance)

Thermocouple only

98 _ _ _ **1** _ _ _ _ (no DIP switches)

Universal signal conditioner

98 _ _ _ **2** _ _ _ _

Input impedance: 20M Ω

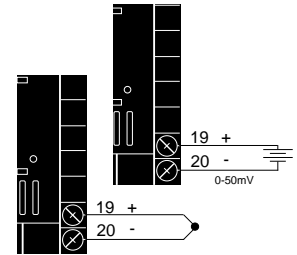
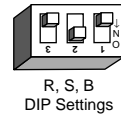
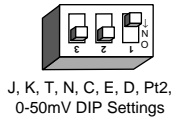

Figure 2.9b — RTD (2- or 3-wire) (100 Ω)

Universal signal conditioner

98 _ _ _ **2** _ _ _ _

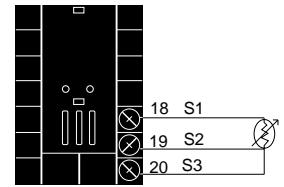
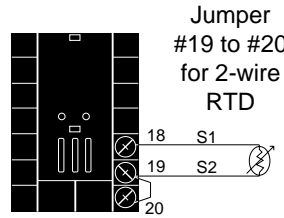
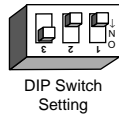

Figure 2.9c — 0-5V_{DC}, 1-5V_{DC} or 0-10V_{DC} Process

Universal signal conditioner

98 _ _ _ **2** _ _ _ _

Input impedance: 10K Ω

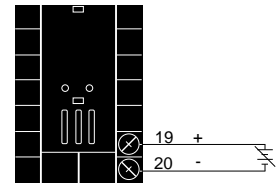
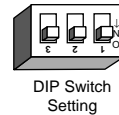
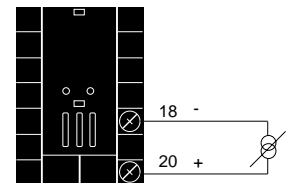
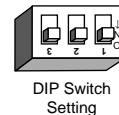

Figure 2.9d — 0-20mA or 4-20mA Process

Universal signal conditioner

98 _ _ _ **2** _ _ _ _

Input impedance: 7 Ω



Input 2 Wiring

NOTE:
See Chapter 8 for information on slidewire feedback.

Figure 2.10a — Slidewire Feedback or Potentiometer Input

98 _ _ _ **3** _ _ _ _ _

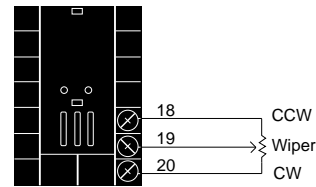

NOTE:
A process output cannot be installed on output 1 when using a current transformer input.

Figure 2.10b — Current Transformer Input

98 _ _ _ **4** _ _ _ _ _

The current transformer must be purchased separately. Watlow current transformer part number 16-0246 (up to 50 amps).

Systems that use more than 50 Amps need an interstage transformer. For example, if you use a 300A current transformer, part #16-0073, and an interstage transformer, part #16-0176, the 300A current transformer provides a 5A signal to the interstage transformer. In turn, the transformer sends a 20mA maximum signal to the controller.

- NOTE:**
Successful installation requires five steps:
- Model number and software choice (Appendix);
 - DIP switch settings (Chapter 1);
 - Sensor match (Chapter 2 and Appendix);
 - Sensor installation (Chapter 2); and
 - Wiring (Chapter 2).

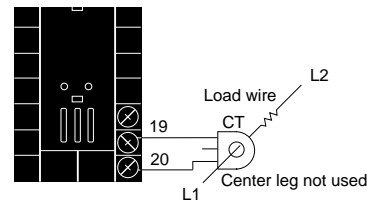

Single-phase

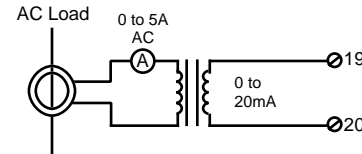

Single-phase current sensing up to 300 amps

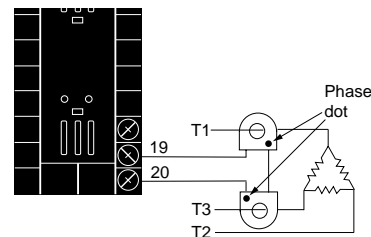

3-phase using 2 current transformers

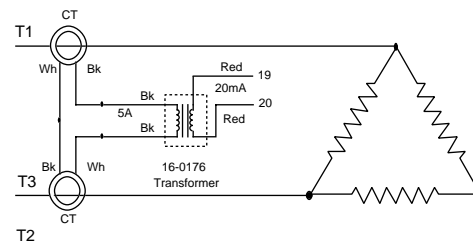

3-phase current sensing up to 300 amps.

Event Input 1 Wiring

Figure 2.11a — Digital Event Input 1

NOTE:

Successful installation requires five steps:

- Model number and software choice (Appendix);
- DIP switch settings (Chapter 1);
- Sensor match (Chapter 2 and Appendix);
- Sensor installation (Chapter 2); and
- Wiring (Chapter 2).

Available on all units.

open 14-36V_{DC} Event Input 1 off
closed 0-3V_{DC} Event Input 1 on

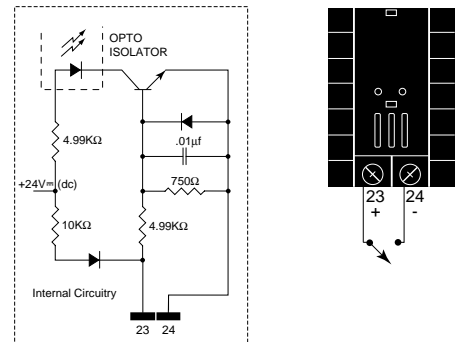
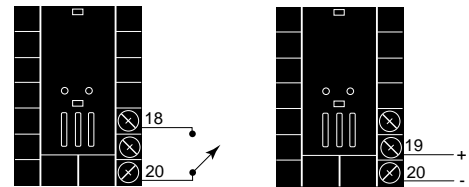
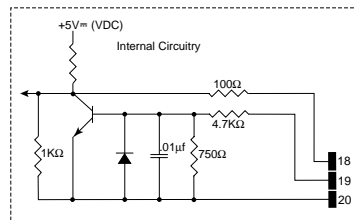

Figure 2.10c — Digital Event Input 2

98 - - **5** - - - -

open 0-3V_{DC} Event Input 2 off
closed 14-36V_{DC} Event Input 2 on



Output 1 Wiring

NOTE:

Successful installation requires five steps:

- Model number and software choice (Appendix);
- DIP switch settings (Chapter 1);
- Sensor match (Chapter 2 and Appendix);
- Sensor installation (Chapter 2); and
- Wiring (Chapter 2).

NOTE:

Switching inductive loads (relay coils, solenoids, etc.) with the mechanical relay or solid state relay output options requires using an R.C. suppressor. Watlow carries the R.C. suppressor Quencharc brand name, which is a trademark of ITW Paktron. Watlow Part No. 0804-0147-0000.

Figure 2.12a — AC Outputs

Solid-state Relay *with* Contact Suppression

98 _ _ _ **B** _ _ _ _ _
 0.5 amps, minimum off-state impedance: 20KΩ

Electromechanical Relay *with* Contact Suppression (Suppression between NO and COM contacts only)

98 _ _ _ **D** _ _ _ _ _
 Form C, 5 amps, minimum off-state impedance: 20KΩ

Electromechanical Relay *without* Contact Suppression

98 _ _ _ **E** _ _ _ _ _
 Form C, 5 amps off-state impedance: 31MΩ

Solid-state Relay *without* Contact Suppression

98 _ _ _ **K** _ _ _ _ _
 0.5 amps, off-state impedance: 31MΩ

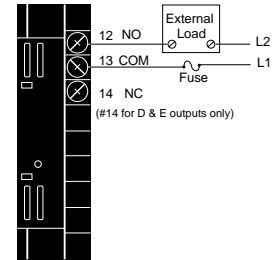

Figure 2.12b — Switched DC, Open Collector

98 _ _ _ **C** _ _ _ _ _

Maximum voltage: 42V^{DC} (dc)
 Maximum current: 1A

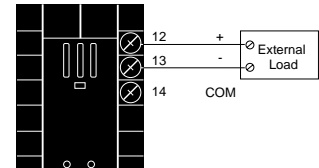
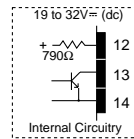

Figure 2.12c — 0-20mA and 4-20mA Process

98 _ _ _ **F** _ _ _ _ _

Maximum load impedance: 800Ω

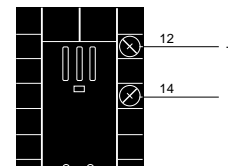

Figure 2.12d — 0-5V^{DC}, 1-5V^{DC} and 0-10V^{DC} Process

98 _ _ _ **F** _ _ _ _ _

Minimum load impedance: 1KΩ

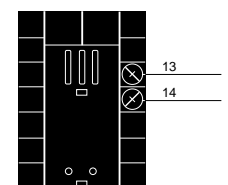

Figure 2.13a — AC Outputs

NOTE:

Successful installation requires five steps:

- Model number and software choice (Appendix);
- DIP switch settings (Chapter 1);
- Sensor match (Chapter 2 and Appendix);
- Sensor installation (Chapter 2); and
- Wiring (Chapter 2).

Solid-state Relay *with* Contact Suppression

98 _ _ - _ _ _ **B** - _ _ _ _

0.5 amps, minimum off-state impedance: 20KΩ

Electromechanical Relay *with* Contact Suppression

(Suppression between NO and COM contacts only)

98 _ _ - _ _ _ **D** - _ _ _ _

Form C, 5 amps, minimum off-state impedance: 20KΩ

Electromechanical Relay *without* Contact Suppression

98 _ _ - _ _ _ **E** - _ _ _ _

Form C, 5 amps off-state impedance: 31MΩ

Solid-state Relay *without* Contact Suppression

98 _ _ - _ _ _ **K** - _ _ _ _

0.5 amps, off-state impedance: 31MΩ

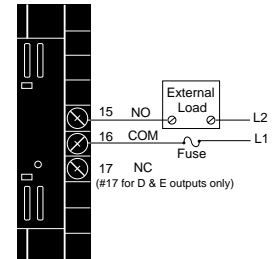

Figure 2.13b — Switched DC, Open Collector

NOTE:

Switching inductive loads (relay coils, solenoids, etc.) with the mechanical relay or solid state relay output options requires using an R.C. suppressor. Watlow carries the R.C. suppressor Quencharc brand name, which is a trademark of ITW Paktron. Watlow Part No. 0804-0147-0000.

98 _ _ - _ _ _ **C** - _ _ _ _

Maximum voltage: 42V^{DC}

Maximum current: 1A

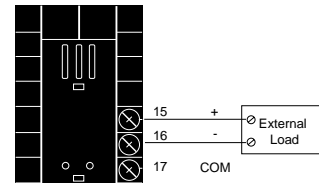
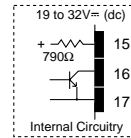

Figure 2.13c — 0-20mA and 4-20mA Process

98 _ _ - _ _ _ **F** - _ _ _ _

Maximum load impedance: 800Ω

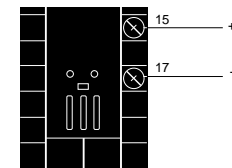

Figure 2.13d — 0-5V^{DC}, 1-5V^{DC} and 0-10V^{DC} Process

NOTE:

Input-to-output isolation is defeated when the external signal conditioner power supply is used to power a transmitter connected to input 1 or input 2.

98 _ _ - _ _ _ **F** - _ _ _ _

Minimum load impedance: 1KΩ

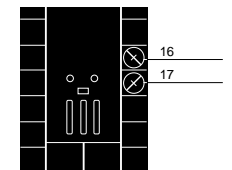
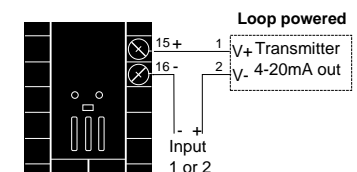

Figure 2.13e — External Signal Conditioner Power Supply

98 _ _ - _ _ _ **T** - _ _ _ _



Output 3 Wiring

NOTE:
Successful installation requires five steps:

- Model number and software choice (Appendix);
- DIP switch settings (Chapter 1);
- Sensor match (Chapter 2 and Appendix);
- Sensor installation (Chapter 2); and
- Wiring (Chapter 2).

Figure 2.14a — AC Outputs

Solid-state Relay with Contact Suppression
98 ___ - ___ - **B** ___
0.5 amps, minimum off-state impedance: 20KΩ

Electromechanical Relay without Contact Suppression
98 ___ - ___ - **J** ___
Form A or B, 5 amps, off-state impedance: 31MΩ

Solid-state Relay without Contact Suppression
98 ___ - ___ - **K** ___
0.5 amps, off-state impedance: 31MΩ

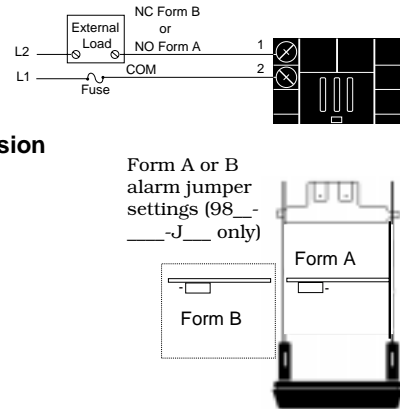

NOTE:
Switching inductive loads (relay coils, solenoids, etc.) with the mechanical relay or solid state relay output options requires using an R.C. suppressor. Watlow carries the R.C. suppressor Quencharc brand name, which is a trademark of ITW Paktron. Watlow Part No. 0804-0147-0000.

Figure 2.14b — Switched DC

98 ___ - ___ - **C** ___
Minimum load resistance: 500Ω

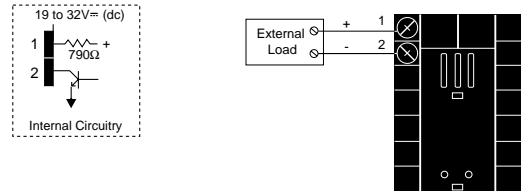
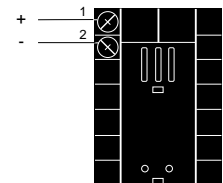

Figure 2.14c — Process Retransmit

0-20mA, 4-20mA, Load impedance: 600Ω max.
98 ___ - ___ - **M** ___

0-5V[±], 1-5V[±], 0-10V[±] (VDC), Load impedance: 500Ω min.
98 ___ - ___ - **N** ___



NOTE:
Input-to-output isolation is defeated when the external signal conditioner power supply is used to power a transmitter connected to input 1 or input 2.

Figure 2.14d — External Signal Conditioner Power Supply

98 ___ - ___ - **T** ___

NOTE:
See Chapter 1 for power supply DIP switch information.

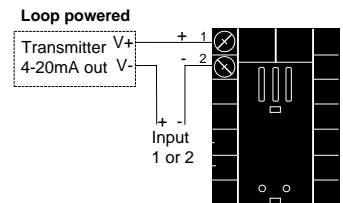

NOTE:

Successful installation requires five steps:

- Model number and software choice (Appendix);
- DIP switch settings (Chapter 1);
- Sensor match (Chapter 2 and Appendix);
- Sensor installation (Chapter 2); and
- Wiring (Chapter 2).

NOTE:

Switching inductive loads (relay coils, solenoids, etc.) with the mechanical relay or solid state relay output options requires using an R.C. suppressor. Watlow carries the R.C. suppressor Quencharc brand name, which is a trademark of ITW Paktron. Watlow Part No. 0804-0147-0000.

NOTE:

Input-to-output isolation is defeated when the external transmitter power supply is used to power a signal conditioner connected to input 1 or input 2.

Figure 2.15a — AC Outputs

Solid-state Relay *with* Contact Suppression

98 _ _ - _ _ _ _ _ - _ **B** _ _
 0.5 amps, minimum off-state impedance: 20KΩ

Electromechanical Relay *with* Contact Suppression (Suppression between NO and COM contacts only)

98 _ _ - _ _ _ _ _ - _ **D** _ _
 Form C, 5 amps, minimum off-state impedance: 20KΩ

Electromechanical Relay *without* Contact Suppression

98 _ _ - _ _ _ _ _ - _ **E** _ _
 Form C, 5 amps, off-state impedance: 31MΩ

Solid-state Relay *without* Contact Suppression

98 _ _ - _ _ _ _ _ - _ **K** _ _
 0.5 amps, off-state impedance: 31MΩ

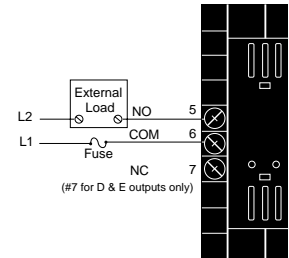

Figure 2.15b — Switched DC, Open Collector

98 _ _ - _ _ _ _ _ - _ **C** _ _

Maximum voltage: 42V^{dc}
 Maximum current: 1A

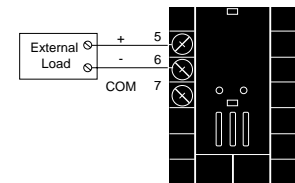
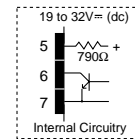
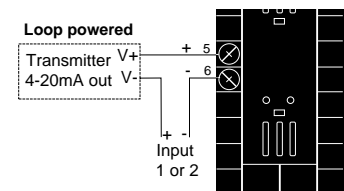

Figure 2.15c — External Signal Conditioner Power Supply

98 _ _ - _ _ _ _ _ - _ **T** _ _

NOTE:
 See Chapter 1 for power supply DIP switch information.



Controllers with Output 4 (R, S, or U)

For data communications wiring refer to “*Data Communications with the Watlow Series 988 Family of Controllers*” manual. This manual can be downloaded from Watlow’s website at www.watlow.com, Product Technical Information - Controls.

Chapter 3 Front Panel and Display Loop

Keys and Displays

Upper Display

Indicates the actual process value, prompt parameter value or error code.

DEV LED

When lit, the lower display shows the most recent deviation unit from the set point.

% OUT LED

When lit, the lower display shows the current percent output.

Up-arrow Key

Increases the value or changes the parameter in the upper display (except for set point changes in the Display Loop, which occur in the lower display). Hold the key down to increase the value rapidly. New data takes effect in five seconds or when the Mode key or Display key is pressed.

Down-arrow Key

Decreases the value or changes the parameter in the upper display (except for set point changes in the Display Loop, which occur in the lower display). Hold the key down to decrease the value rapidly. New data takes effect in five seconds or when the Mode key or Display key is pressed.

Up + Down Keys

Press simultaneously for three seconds to go to the Setup Menu. Continue to press both keys for another three seconds to go to the Factory Menu. Access to the Setup and Factory menus can be disabled with lockout DIP switch.

Lower Display

Indicates the set point, deviation, percent power, temperature unit, menu prompt name or alarm code.

L1, L2, L3, L4

These LED's indicate when output 1, 2, 3 or 4 are active. Outputs can be configured as:

Ot1	Control
Ot2	Control or Alarm
Ot3	Alarm or Retransmit
Ot4	Alarm or Communications (flashes on transmit and receive)

Display Key

Pressing this key enters the Display Loop. Press the Display key at any time to return to this loop. The next page has more information on the Display Loop.

Auto/Man Key

In Manual mode the lower display shows percent output. Pressed once, it clears any latched alarm. If pressed again within five seconds it will toggle between Auto and Manual mode.

Auto/Man LED

Lit when the control is in Manual operation. Press the Auto/Man key twice to enter Automatic operation. When blinking, press the Auto/Man key to toggle between Auto and Manual. After five seconds without pressing the Auto/Man key, the LED stops blinking and returns to its previous state.

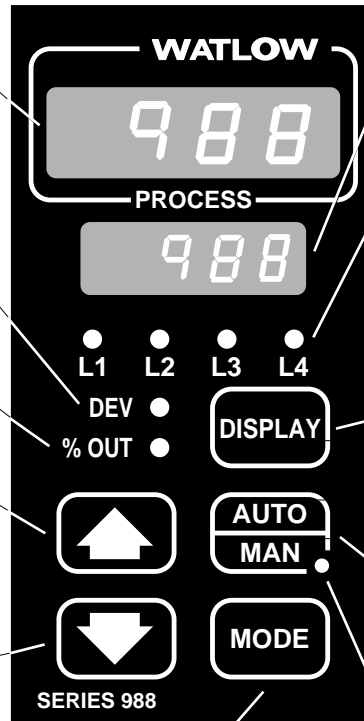

Mode Key

Enters new data and steps to the next prompt in the current menu.

Mode + Up-arrow Keys

Hold the Mode key then press the Up-arrow key to move backwards through the current menu. Scrolling stops when you reach the top of the menu.



Figure 3.1 - Series 988 Keys and Displays

Display Loop

Display Loop

The Display Loop is the “home” state of the Series 988 controller. Pressing the Display key  returns the controller to the Display Loop from any prompt in any menu. The controller automatically returns to the Display Loop from any menu when a minute passes without any keys being pressed.

NOTE:

For information on input 1  and input 2  ranges, refer to Chapter 4.

NOTE:



If  is selected for , in the Input Menu, the  prompt will not appear.

Figure 3.2 -
The Display Loop



Chapter 4 The Setup Menus

NOTE:
When navigating through menus, outputs will be disabled.

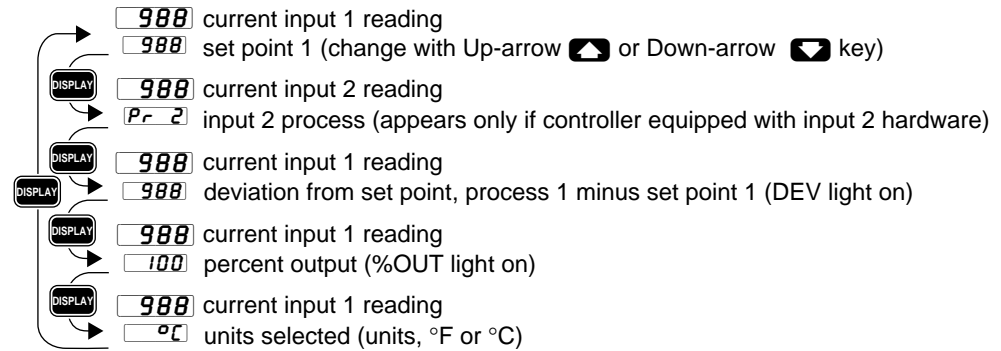
NOTE:
Press the Display key **DISPLAY** to return to the Display Loop from any point in any menu.

Navigating the Setup Menu

To reach the Setup Menu, begin in the Display Loop and press both the Up-arrow **▲** and Down-arrow **▼** keys for three seconds. The Setup Menu prompt **SEE** will appear in the lower display, and the Input Menu prompt **InPt** will appear in the upper display. The four Setup Menus are: Input **InPt**; Output **DEPt**; Global **GLbL**; and Communications **COMM**. Use the Up-arrow **▲** or Down-arrow **▼** key to select a menu and the Mode key **MODE** to step through a menu. The Communications Menu appears only on units equipped with the data communications option.

You will not see every prompt in any of these menus. The unit's configuration and model number determine which prompts appear. After stepping through each menu, the Series 988 returns to the Setup Menu prompt **SEE**. Use the Up-arrow **▲** and Down-arrow **▼** keys to select the next menu, or use the Mode key **MODE** to advance through the same menu again. To move backwards through the menu hold the Mode key **MODE** down and press the Up-arrow key **▲**. Use the Up-arrow **▲** or Down-arrow **▼** key to change the prompt setting.

Refer to the Appendix for model number options. For information about communications and the communications prompts, refer to the supplemental manual *Data Communications with the Watlow Series 988 Family of Controllers*.



① Begin in the Display Loop, and press the Up-arrow **▲** and Down-arrow **▼** keys simultaneously to reach the Setup Menu.

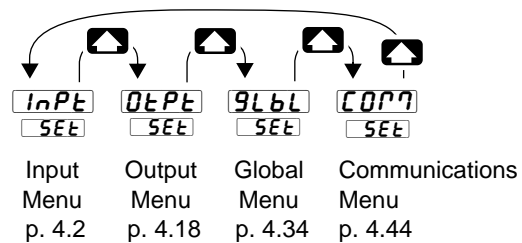

Figure 4.1 - Navigating the Setup Menus.

NOTE:
The lockout DIP switch hides the Setup Menu. See Chapter 1.



② Press the Up-arrow key **▲** to select one of the Setup Menus.

Setup-Input

Reaching the Input Menu

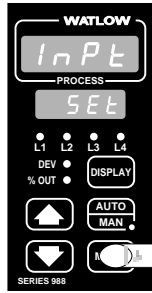

③ Select the Input Menu, then press the Mode key **MODE** to step through the prompts.

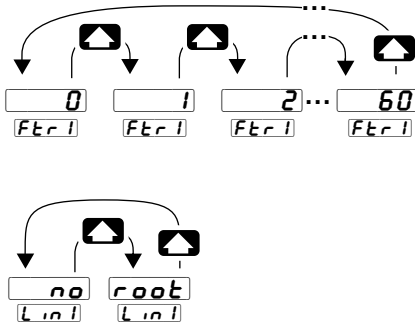

④ Press the Up-arrow key or the Down-arrow key to select one of the prompt values.

*Prompts may not appear, depending on controller configuration.

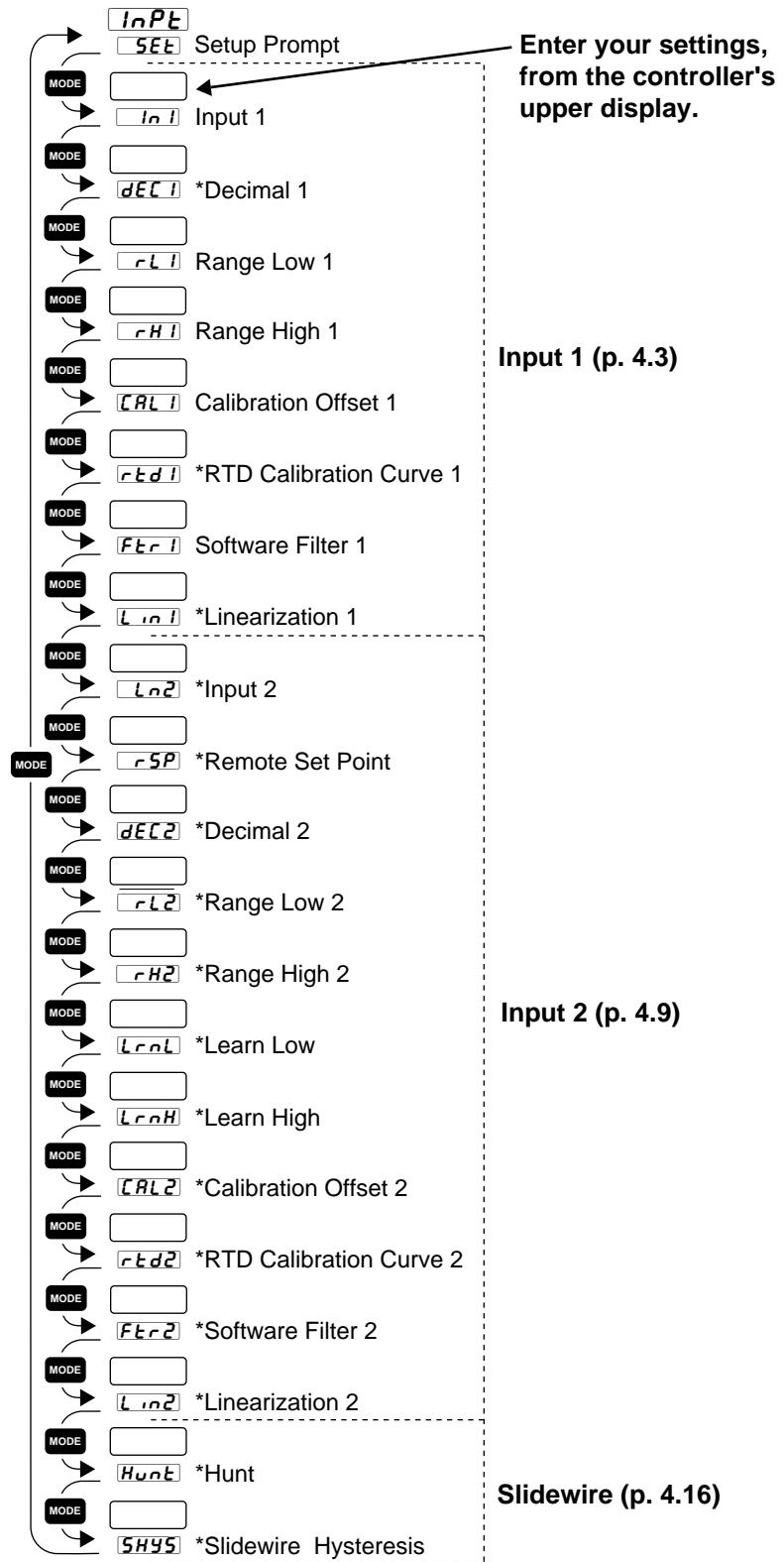

Figure 4.2 - The Input Menu.

Input Prompts

NOTE:
 Decimal points may not always be in the position specified below depending on the the settings in the Decimal 1 **dEC1** and Decimal 2 **dEC2** parameters in the Input Menu.



CAUTION:
 Changing the value of **In 1** changes most other prompts to the factory default values. Document all settings before changing sensor type. Verify the correct sensor type before making a change. Failure to follow this guideline could result in damage to equipment or property. Document all settings before changing sensor type.

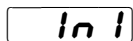

Input 1 continued on next page.

When you are in the Setup menus, the Series 988 displays the menu selection (**InPt**, **DEPt**, **9LbL** or **COPT**) in the upper display, and **SEt** in the lower display.

The Up-arrow or Down-arrow key selects another menu. Press the Mode key **MODE** to display the prompt in the lower display and its value in the upper display. Use the Up-arrow or Down-arrow key to change the value in the upper display. The new value will not take effect until after a five-second delay or until you press the Mode key **MODE**.

Input 1

Select sensor type for input 1. This selection must match the sensor type connected to terminals 8, 9 and 10. See Appendix for more information about sensors.

- Changing the value of **In 1** changes all other prompts to the factory default values, except the Communications and Lockout menus, the **C_F** prompt in the Global Menu and the **dFL** prompt in the Calibration Menu. If you change the value, the default warning **dFLt** will flash in the upper display.
- Changes do not take effect automatically after five seconds; you must press the Mode key **MODE** to enter the sensor type change and advance to the next prompt.

In 1 This prompt always appears.

	If	Default											
98	-1	-											
	no DIP	J	K	T	N	E	W5	W3	Pt2	0-50mV			
	thermocouple only												
		In 1	In 1	In 1	In 1	In 1	In 1	In 1	In 1	In 1			
98	-2	-											
	Input 1 DIP	J	K	T	N	E	W5	W3	Pt2	0-50mV			
	thermocouple	In 1	In 1	In 1	In 1	In 1	In 1	In 1	In 1	In 1			
	Input 1 DIP	R	S	B									
	thermocouple	In 1	In 1	In 1									

Setup-Input

ln 1

Input 1 continued from previous page.

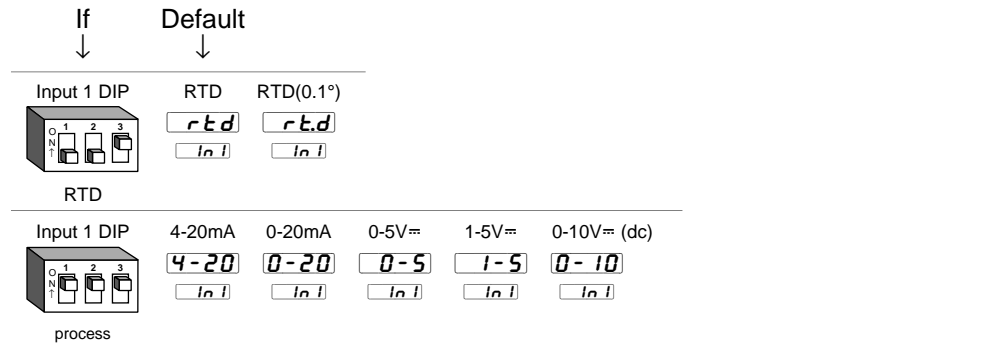

dEC 1

Decimal 1

Select the decimal point location for process type input 1 data. This prompt, in conjunction with the Range Low and Range High prompts, allows you to format and limit units of measure for process 1.

- All prompts with units of measure related to input 1 will display in the selected decimal format.
- This affects propbands, alarm set points, process set points, calibration offsets, deadbands and ranges.

dEC 1 This prompt appears only if you have set input 1 **ln 1** to a process input or to a thermocouple input set to 0-50mV.



rL1

rH1

Range Low 1 and Range High 1

Select the low and high limits for input 1. These prompts limit the adjustment range for the set points. The default values are the same as the limits of the sensor you selected by setting the input 1 DIP switch and selecting a value for Input 1 **in1**.

- Process inputs are scaled by these values. Range high is the value displayed when the maximum process signal is present at the input. Range low is the value displayed when the minimum process signal is present at the input.

NOTE:
These values do not affect the low or the high set point limit for process alarms.

Example: Set **in1** to **4-20** mA.
Set **rL1** to **100**.
Set **rH1** to **500**.
A 4mA input will display **100**.
A 12mA input will display **300**.
A 20mA input will display **500**.

- The low and high values of each sensor type are listed on the specifications page of the Appendix.
- Choose between Fahrenheit and Celsius at the **C_F** prompt in the Global Menu.

rL1 **rH1** These prompts always appear.

NOTE:
When high impedance **0-50** is selected for input 1 the range high for both **°C** and **°F** can be extended to **9999**. The range low when **°C** is selected can be extended to **-999**.

rL1

rH1

Range Low 1 and Range High 1 continued on next page.

	Default ↓ °F	Default ↓ °C	Default ↓ °F	Default ↓ °C
J	32 ... 1500	0 ... 816	0 ... 816	0 ... 816
n	32 ... 1500	0 ... 816	0 ... 816	0 ... 816
(K)	-328 ... 2500	-200 ... 1371	-200 ... 1371	-200 ... 1371
H	-328 ... 2500	-200 ... 1371	-200 ... 1371	-200 ... 1371
E	-328 ... 750	-200 ... 399	-200 ... 399	-200 ... 399
n	32 ... 2372	0 ... 1300	0 ... 1300	0 ... 1300
E	-328 ... 1470	-200 ... 799	-200 ... 799	-200 ... 799
(W5)	32 ... 4200	0 ... 2316	0 ... 2316	0 ... 2316
C	32 ... 4200	0 ... 2316	0 ... 2316	0 ... 2316
(W3)	32 ... 4200	0 ... 2316	0 ... 2316	0 ... 2316
d	32 ... 4200	0 ... 2316	0 ... 2316	0 ... 2316
Pt2	32 ... 2543	0 ... 1395	0 ... 1395	0 ... 1395
high impedance 0-50	-999 ... 999	-573 ... 573	-573 ... 573	-573 ... 573

Setup-Input

rL1
rH1

Range Low 1 and
Range High 1
continued from
previous page.

NOTE:
These values do not
affect the low or the
high set point limit
for process alarms.

	oF <small>rL1 rH1</small>	oC <small>rL1 rH1</small>	
only	r 32..3200	0 ..1760	98_-2_-_-_-
	in1		
	S 32..3200	0 ..1760	
	b 32..3300	0 ..1816	
	rt.d -328..1472	-200 ..800	
	rt.d -999..9999	-733 ..5377	
	4-20	-999 ..9999	units
	0-20	-999 ..9999	units
	0-5	-999 ..9999	units
	1-5	-999 ..9999	units
	0-10	-999 ..9999	units

CAL1

Calibration Offset 1

Offset the input 1 signal by a positive or negative value. This allows you to compensate for lead resistance, sensor errors or other factors.

CAL1 This prompt always appears.

If	Default
oF <small>C.F</small> (Global Menu)	-999 ... 0 ... 9999 <small>CAL1 CAL1 CAL1</small>
oF & rt.d <small>C.F in1</small> (Global Menu) (Input Menu)	-999 ... 0.0 ... 999 <small>CAL1 CAL1 CAL1</small>
oC <small>C.F</small> (Global Menu)	-999 ... 0 ... 9999 <small>CAL1 CAL1 CAL1</small>
oC & rt.d <small>C.F in1</small> (Global Menu) (Input Menu)	-55.5 ... 0.0 ... 55.5 <small>CAL1 CAL1 CAL1</small>
a process input is selected	-999 ... 0 ... 999 units <small>CAL1 CAL1 CAL1</small>

rt d 1

RTD (100Ω) Calibration Curve 1

Select the calibration curve for the RTD 1 input. The RTD input uses either the European (DIN, 0.003850Ω/Ω/°C) or the Japanese (JIS, 0.003916Ω/Ω/°C) linearization standard.

rt d 1 This prompt appears only if you have set in 1 to r t d or r t . d .

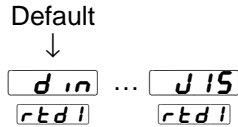

f t r 1

Software Filter 1

Select the filter time constant, in seconds, for input 1. This smooths a rapidly changing input signal for display or control purposes.

- Select a positive value to filter only the display.
- Select a negative value to filter the input signal.
- Set the value to 0 to disable the filter.

f t r 1 This prompt always appears.

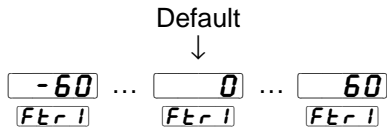

Setup-Input

L i n 1

Linearization 1

Select square root linearization for input 1.

L i n 1 This prompt appears only if you have set **I n 1** to a process input or to a thermocouple set to **0-50**mV.

NOTE:
See Chapter 8 for more information on input linearization.

Default



no

root

L i n 1

L i n 1

in2

Input 2

Select sensor type for input 2. This selection must match the sensor type connected to terminals 18, 19 and 20. See Appendix for more information about sensors.

CAUTION:

Changing the value of **in2** changes most other prompts to the factory default values. Document all settings before changing sensor type. Verify the correct sensor type before making a change. Failure to follow this guideline could result in damage to equipment or property. Document all settings before changing sensor type.

- Changing the value of **in2** changes all other prompts to the factory default values, except the Communications and Lockout menus, the **C_F** prompt in the Global Menu and the **dFL** prompt in the Calibration Menu. If you change the value, the default warning **dFLt** will flash in the upper display.

- Changes do not take effect automatically after five seconds; you must press the Mode key **MODE** to enter the sensor type change and advance to the next prompt.

in2 This prompt and other Input 2 prompts appear only on controllers equipped with input 2 hardware (not 98__-0__-__-__).

NOTE:

If **no** is selected for **in2** none of the other input 2 prompts will appear.

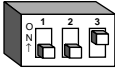
	If ↓	Default ↓									
98__-1__-__-__	no DIP		J	K	T	N	E	W5	W3	Pt2	0-50mV
		no	J	H	t	n	E	C	d	Pt2	0-50
	thermocouple only	in2	in2	in2	in2	in2	in2	in2	in2	in2	in2
98__-2__-__-__	Input 2 DIP		J	K	T	N	E	W5	W3	Pt2	0-50mV
		no	J	H	t	n	E	C	d	Pt2	0-50
	thermocouple	in2	in2	in2	in2	in2	in2	in2	in2	in2	in2
	Input 2 DIP		R	S	B						
		no	r	S	b						
	thermocouple	in2	in2	in2	in2						
	Input 2 DIP		RTD	RTD (0.1°)							
		no	rtd	rtd							
	RTD	in2	in2	in2							
	Input 2 DIP		4-20mA	0-20mA	0-5V=	1-5V=	0-10V= (dc)				
		no	4-20	0-20	0-5	1-5	0-10				
	process	in2	in2	in2	in2	in2	in2				

in2

Input 2 continued on next page.

Setup-Input

ln2

Input 2 continued from previous page.

	If	Default	
98	-3	-	
	no DIP		slidewire potentiometer
		no	SL id PDE
	resistance only	ln2	ln2 ln2
98	-4	-	
	no DIP		current
	current transformer only	no	SL id ln2
		ln2	ln2
98	-5	-	
	no DIP		event 2
	digital event only	no	EL2 ln2
		ln2	ln2

rSP

Remote Set Point

Enable a remote set point signal.

rSP This prompt appears only if the controller is equipped with input 2 hardware and if **ln2** is not set to **no** and if **CTL** (in the Global Menu) is set to **nor**.

Default	
↓	
OFF	On
rSP	rSP

dEC2

Decimal 2

Select the decimal point location for process type input 2 data. This prompt, in conjunction with the Range Low and Range High prompts, allows you to format and limit units of measure for process 2.

- All prompts with units of measure related to input 2 will display in the selected decimal format.
- This affects propbands, alarm set points, process set points, calibration offsets, deadbands and ranges.

dEC2 This prompt appears only if you have set input 2 **ln2** to a process input, **curr** or a thermocouple input set to **0-50** mV.

Default



0. **0.0** **0.00** **0.000**
dEC2 **dEC2** **dEC2** **dEC2**

rL2

rH2

Range Low 2 and Range High 2

Select the low and high limits for input 2. These prompts limit the adjustment range for the set points. The default values are the same as the limits of the sensor you selected by setting the input 2 DIP switch and selecting a value for Input 2 **ln2**.

- Process inputs are scaled by these values. Range high is the value displayed when the maximum process signal is present at the input. Range low is the value displayed when the minimum process signal is present at the input.

Example: Set **ln2** to **4-20** mA.
 Set **rL2** to **100**.
 Set **rH2** to **500**.
 A 4mA input will display **100**.
 A 12mA input will display **300**.
 A 20mA input will display **500**.

- The low and high values of each sensor type are listed on the specifications page of the Appendix.
- Choose between Fahrenheit and Celsius at the **C_F** prompt in the Global Menu.

rL2 **rH2** These prompts appear only if the controller is equipped with input 2 hardware and with Input 2 **ln2** not set to **no** or **E.2**.

rL2

rH2

*Range Low 2 and
 Range High 2
 continued on next
 page.*

Setup-Input

RL2

RH2

Range Low 2 and Range High 2 continued from previous page.

NOTE:
These values do not affect the low or the high set point limit for process alarms.

NOTE:
When high impedance **0-50** is selected for input 1 the range high for both **oC** and **oF** can be extended to **9999**. The range low when **oC** is selected can be extended to **-999**.

	Default ↓	Default ↓	Default ↓	Default ↓	
		oF		oC	
RL2	RL2	RH2	RL2	RH2	
J	32 ...	1500	0 ...	816	98 -1 - - - or
in2	RL2	RH2	RL2	RH2	98 -2 - - -
(K)					
H	-328 ...	2500	-200 ...	1371	
t	-328 ...	750	-200 ...	399	
n	32 ...	2372	0 ...	1300	
E	-328 ...	1470	-200 ...	799	
(W5)					
C	32 ...	4200	0 ...	2316	
(W3)					
d	32 ...	4200	0 ...	2316	
PE2	32 ...	2543	0 ...	1395	
high impedance					
0-50	-999 ...	999	-573 ...	573	
r	32 ...	3200	0 ...	1760	98 -2 - - - only
S	32 ...	3200	0 ...	1760	
b	32 ...	3300	0 ...	1816	
rEd	-328 ...	1472	-200 ...	800	
rEd	-999 ...	9999	-733 ...	5377	
4-20		-999 ...	9999	units	
0-20		-999 ...	9999	units	
0-5		-999 ...	9999	units	
1-5		-999 ...	9999	units	
0-10		-999 ...	9999	units	
0-50		-999 ...	9999	units	
0-100		-999 ...	9999	units	
slidewire					
SL rd		100 ...	1200	ohms	
current					
curr		0 ...	50	amps	
potentiometer					
PDE		0 ...	1200	ohms	

Lrnl

Learn Low

Write the low-end resistance of the slidewire potentiometer to the range low 2 parameter.

Lrnl This prompt appears only on controllers equipped with input 2 hardware and with Input 2 set to or .

NOTE:
See Chapter 8 for more information on slidewire feedback.

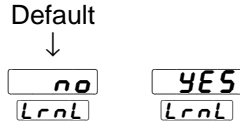

LrnH

Learn High

Write the high-end resistance of the slidewire potentiometer to the range low 2 parameter.

LrnH This prompt appears only on controllers equipped with input 2 hardware and with Input 2 set to or .

NOTE:
See Chapter 8 for more information on slidewire feedback.

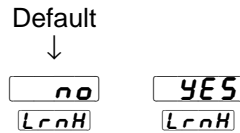

CAL2

Calibration Offset 2

Offset the input 2 signal by a positive or negative value. This allows you to compensate for lead resistance, sensor errors or other factors.

CAL2 This prompt appears only if the controller is equipped with input 2 hardware and if **in2** is not set to **no** or **εi2**.

If ↓	Minimum	Default ↓	Max. setting/range
oF C.F (Global Menu)	-999 ... CAL2	0 ... CAL2	999 CAL2
oF & rt.d C.F in2 (Global Menu) (Input Menu)	-999 ... CAL2	0.0 ... CAL2	999 CAL2
oC C.F (Global Menu)	-555 ... CAL2	0 ... CAL2	555 CAL2
oC & rt.d C.F in2 (Global Menu) (Input Menu)	-555 ... CAL2	0.0 ... CAL2	555 CAL2
a process input is selected	-999 ... CAL2	0 ... CAL2	999 units CAL2

rt.d2

RTD Calibration Curve 2

Select the calibration curve for the RTD 2 input. The RTD input uses either the European (DIN, 0.003850Ω/Ω/°C) or Japanese (JIS, 0.003916Ω/Ω/°C) linearization standard.

rt.d2 This prompt appears only on controllers equipped with input 2 hardware and with **in2** set to **rt.d** or **rt.d**.

Default ↓
d in JIS rt.d2 rt.d2

Ftr2

Software Filter 2

Select the filter time constant, in seconds, for input 2. This smooths a rapidly changing input signal for display or control purposes.

- Select a positive value to filter only the display.
- Select a negative value to filter the input signal.
- Set the value to to disable the filter.

Ftr2 This prompt appears only on controllers equipped with input 2 hardware and with **ln2** not set to **no** or **ε.2**.



Ln2

Linearization 2

Select square root linearization for input 2.

Ln2 This prompt appears only if you have set Input 2 **ln2** to a process input or to a thermocouple input set to **0-50** mV.

NOTE:
See Chapter 8 for more information on input linearization.

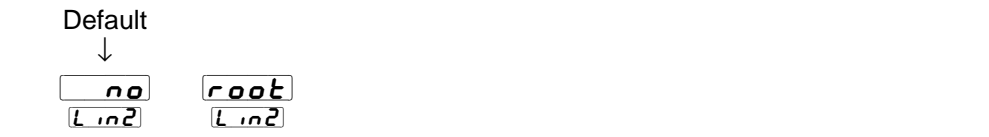

Setup-Input

Hunt

Hunt

Set the deadband, as a percentage of output, to keep the valve from hunting.

NOTE:
See Chapter 8 for more information on slidewire feedback.

- The slidewire hysteresis **SHYS** setting provides additional control over a valve.

Hunt This prompt appears only if the controller is equipped with slidewire hardware (98_ _-3_ _- _ _) and with **ln2** set to **SL id**.



SHYS

Slidewire Hysteresis

Set the inner hysteresis, the point at which the valve output turns off.

- The figure below illustrates the interaction between slidewire hysteresis **SHYS** and hunt **Hunt**.

SHYS This prompt appears only if the controller is equipped with slidewire hardware (98__-3__-__-__) and with Input 2 **In2** set to **SLid**

NOTE:
See Chapter 8 for more information on slidewire feedback.

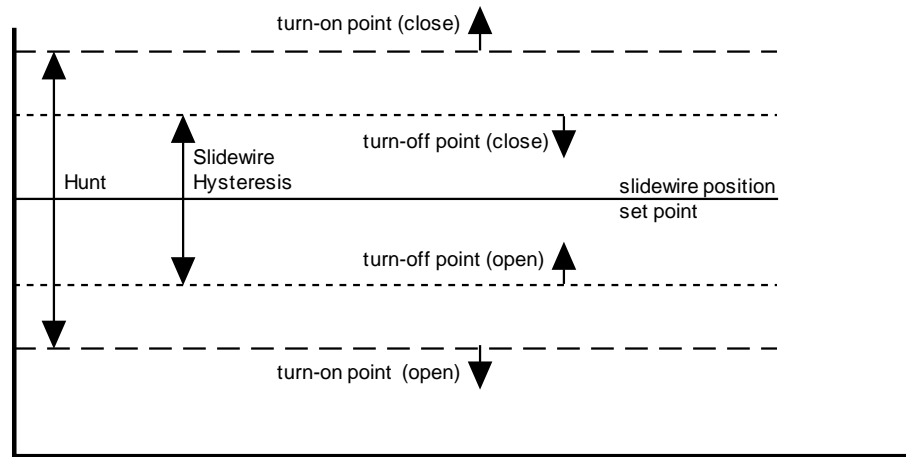
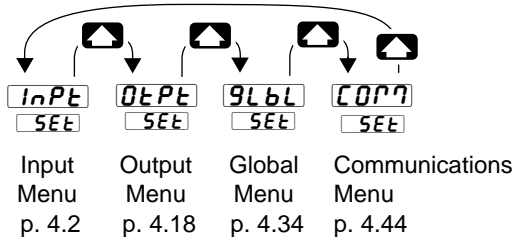

Figure 4.17 - Hunt and slidewire inner hysteresis.

Setup-Output

Reaching the Output Menu

1 Begin in the Display Loop, and press the Up-arrow and Down-arrow keys simultaneously for three seconds to reach the Setup Menu.



2 Press the Up-arrow key to select one of the Setup Menus.

3 Press the Mode key **MODE** to step through the prompts.

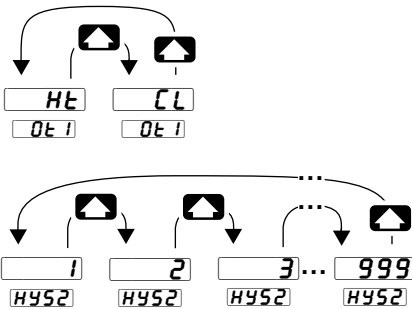

4 Press the Up-arrow key or the Down-arrow key to select one of the prompt values.

*Prompts may not appear, depending on controller configuration.

Figure 4.18 - Navigating the Output Menu.

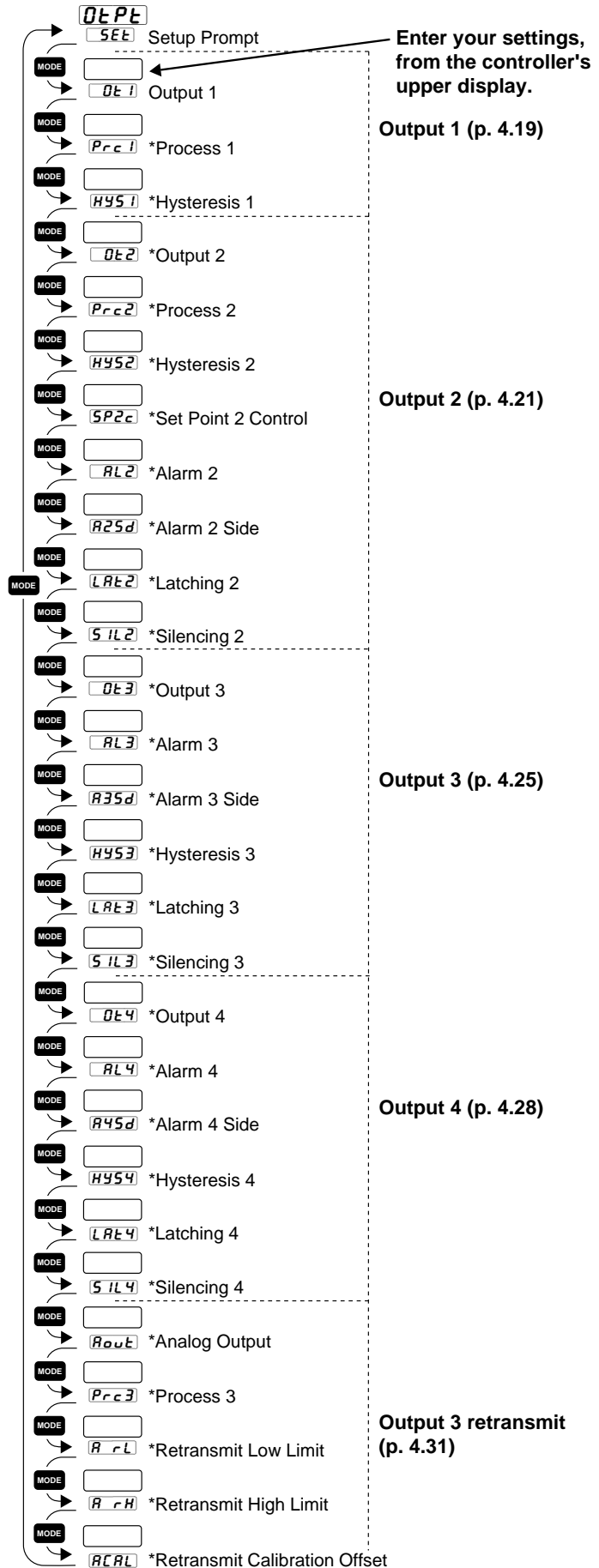





Output Prompts

NOTE:

Decimal points may not always be in the position specified below depending on the the settings in the Decimal 1 `DEC1` and Decimal 2 `DEC2` parameters in the Input Menu.

`0E1`

When you are in the Setup menus, the Series 988 displays the menu selection (`INPT`, `DEPT`, `SLBL` or `COPY`) in the upper display, and `SEE` in the lower display.

The Up-arrow  or Down-arrow key  selects another menu. Press the Mode key `MODE` to display the first prompt in the lower display and its value in the upper display. Use the Up-arrow  and Down-arrow  keys to change the value in the upper display. The new value will not take effect until after a five-second delay or until you press the Mode key `MODE`.

Output 1

Set the way that output 1 will respond to a difference between the set point and an input variable.

- `HE` select reverse action, so that output 1 responds when the input signal is less than the setpoint.
- `CL` select direct action, so that output 1 responds when the input signal is more than the setpoint.

`0E1` This prompt always appears.

Default



<code>HE</code>	<code>CL</code>
<code>0E1</code>	<code>0E1</code>

Setup-Output

Prcl

Process 1

Select the process range for output 1.

Prcl This prompt appears only on controllers equipped with output 1 process hardware (98_ _ _ F_ _ _ _).

Default



4-20mA	0-20mA	0-5V _{ac}	1-5V _{ac}	0-10V _{ac} (dc)
4-20	0-20	0-5	1-5	0-10
Prcl	Prcl	Prcl	Prcl	Prcl

HYS1

Hysteresis 1

Select the switching hysteresis for output 1. This determines the change in temperature or process units needed to turn the output from full on to full off.

HYS1 This prompt does not appear on controllers equipped with output 1 process hardware (98_ _ _ F_ _ _ _). This prompt only appears with the controller set up as an on/off controller (**Pb1A** = **0**).

If ↓	Default ↓	
OF C.F (Global Menu)	1 ... 3 ... 999 HYS1 HYS1 HYS1	
OF & rt.d C.F In1 (Global Menu) (Input Menu)	0.1 ... 3.0 ... 999 HYS1 HYS1 HYS1	
OC C.F (Global Menu)	1 ... 2 ... 555 HYS1 HYS1 HYS1	
OC & rt.d C.F In1 (Global Menu) (Input Menu)	0.1 ... 2.0 ... 555 HYS1 HYS1 HYS1	
a process input is selected	1 ... 3 ... 999 units HYS1 HYS1 HYS1	

0E2

Output 2

Set the way that output 2 will respond to a difference between the set point and an input variable.

- **AL2** de-energizes output 2 in an alarm condition.
- **AL2n** energizes output 2 in an alarm condition.
- **HL** select reverse action, so that output 2 responds when the input signal is less than the set point.
- **CL** select direct action, so that output 2 responds when the input signal is more than the set point.

0E2 This prompt appears only on controllers equipped with output 2 hardware (not 98_ _ _ _ A_ _ _ _). **AL2** and **AL2n** do not appear if output 2 is a process output (98_ _ _ _ F_ _ _ _). **HL** and **CL** do not appear if **AL90** (in the Global Menu) is set to **DUPL**.

Default



<input type="checkbox"/> no	<input type="checkbox"/> AL2	<input type="checkbox"/> AL2n	<input type="checkbox"/> HL	<input type="checkbox"/> CL
<input type="checkbox"/> 0E2	<input type="checkbox"/> 0E2	<input type="checkbox"/> 0E2	<input type="checkbox"/> 0E2	<input type="checkbox"/> 0E2

PrC2

Process 2

Select the process range for output 2.

PrC2 This prompt appears only on controllers equipped with output 2 process hardware (98_ _ _ _ F_ _ _ _) and with **0E2** not set to **no**.

Default



4-20mA	0-20mA	0-5V _m	1-5V _m	0-10V _m (dc)
<input type="checkbox"/> 4-20	<input type="checkbox"/> 0-20	<input type="checkbox"/> 0-5	<input type="checkbox"/> 1-5	<input type="checkbox"/> 0-10
<input type="checkbox"/> PrC2	<input type="checkbox"/> PrC2	<input type="checkbox"/> PrC2	<input type="checkbox"/> PrC2	<input type="checkbox"/> PrC2

HYS2

Hysteresis 2

Select the switching hysteresis for output 2. This determines the change in temperature or process units needed to turn the output from off to on.

- If **AL2** is set to **rAEE** settings for **HYS2** will be in degrees per minute or units per minute.
- If the input referenced by **AL2** is set to **rEd** the range is affected as listed below.

HYS2 This prompt appears only on controllers equipped with output 2 hardware and with the controller set up as an on/off controller (**Pb2A** = **0**), and with **DE2** not set to **no**. This prompt does not appear on controllers equipped with output 2 process hardware, (**ln2** = **SL id**), or if **AL90** in the Global menu = **DUPL**.

If	Default
<div style="text-align: center;">↓</div> <div style="text-align: center;"> oF C_F (Global Menu) </div>	<div style="text-align: center;">↓</div> <div style="text-align: center;"> 1 ... 3 ... 999 HYS2 ... HYS2 ... HYS2 </div>
<div style="text-align: center;"> oF & rEd C_F Input 1 or 2 (Global Menu) (see note above) </div>	<div style="text-align: center;"> 0.1 ... 3.0 ... 999 HYS2 ... HYS2 ... HYS2 </div>
<div style="text-align: center;"> oC C_F (Global Menu) </div>	<div style="text-align: center;"> 1 ... 2 ... 555 HYS2 ... HYS2 ... HYS2 </div>
<div style="text-align: center;"> oC & rEd C_F Input 1 or 2 (Global Menu) (see note above) </div>	<div style="text-align: center;"> 0.1 ... 2.0 ... 555 HYS2 ... HYS2 ... HYS2 </div>
a process input is selected	<div style="text-align: center;"> 1 ... 3 ... 999 units HYS2 ... HYS2 ... HYS2 </div>

SP2c

Set Point 2 Control

Select a second set point.

- **Pr** enables a set point independent from the Set Point 1 **SP1** value.
- **dE** enables a set point at a deviation from the Set Point 1 **SP1** value.

Pr c 1 This prompt appears only if output 2 hardware is present and is equal to the output 1 setting.

Default
<div style="text-align: center;">↓</div> <div style="display: flex; justify-content: space-around;"> <div style="text-align: center;"> Pr SPc2 </div> <div style="text-align: center;"> dE SPc2 </div> </div>

AL2

Alarm 2

Select the alarm type for alarm 2. Select the trigger points for the alarm with the **A2L0** and **A2H1** settings in the System Menu **595**.

- **Pr1** uses the process signal from input 1. Changing the set point does not change the alarm response.
- **dE1** uses a deviation from the input 1 signal. Changing the set point changes the alarm response.
- **Pr2** uses the process signal from input 2. This choice does not appear if the controller is not equipped with input 2 hardware or if **In2** is set to **no** or **E.2**.
- **dE2** uses a deviation from the input 2 signal. This prompt does not appear if the controller is not equipped with input 2 hardware or if **In2** is set to **no** or **E.2**.
- **rAEE** uses the rate of change at input 1 in degrees per minute.

NOTE:
See Chapter 7 for more information on alarms.

AL2 This prompt appears only on controllers equipped with output 2 hardware and with **OE2** set to **AL2** or **AL2n**.

Default



Pr1 **dE1** **Pr2** **dE2** **rAEE** **no**
AL2 **AL2** **AL2** **AL2** **AL2** **AL2**

A25d

Alarm 2 Side

Select what triggers alarm 2.

- **both** triggers an alarm when the signal \leq **A2L0** or \geq **A2H1**.
- **H.9H** triggers an alarm when the signal \geq **A2H1**.
- **LobJ** triggers an alarm when the signal \leq **A2L0**.

A25d This prompt appears only on controllers equipped with output 2 hardware and with **OE2** set to **AL2** or **AL2n**.

Default



both **H.9H** **LobJ**
A25d **A25d** **A25d**

Setup-Output

L A L 2

Latching 2

Select whether alarm 2 will be latching or non-latching. A latching alarm **LAL** must be turned off manually. A non-latching alarm **nLA** turns off when an alarm condition no longer exists.

LAL2 This prompt appears only on controllers equipped with output 2 hardware and with **OE2** set to **AL2** or **AL2n**.

NOTE:
See Chapter 7 for more information on alarms.

Default
↓
nLA **LAL**
LAL2 **LAL2**

S I L 2

Silencing 2

Select silencing to inhibit alarm 2 on startup and to allow the operator to reset the alarm output, not the visual display.

- Silencing disables the alarm until the signal is between **R2LO** and **R2HI**.

AL2 This prompt appears only on controllers equipped with output 2 hardware and with **OE2** set to **AL2** or **AL2n**.

Default
↓
OFF **On**
SIL2 **SIL2**

0E3

Output 3

Select the alarm condition for output 3.

- **AL3** de-energizes output 3 in an alarm condition.
- **AL3n** energizes output 3 in an alarm condition.

0E3 This prompt appears only on controllers equipped with output 3 hardware for a relay (98____-B____, 98____-J____ or 98____-K____) or switched dc (98____-C____).

NOTE:
See Chapter 7 for more information on alarms.

Default



AL3	AL3n	no
0E3	0E3	0E3

AL3

Alarm 3

Select the alarm type for alarm 3.

- **Pr1** uses the process signal from input 1.
- **dE1** uses a deviation from the input 1 signal.
- **Pr2** uses the process signal from input 2. This prompt does not appear if the controller is not equipped with input 2 hardware or if **in2** is set to **no** or **Ei2**.
- **dE2** uses a deviation from the input 2 signal. This prompt does not appear if the controller is not equipped with input 2 hardware or if **in2** is set to **no** or **Ei2**.
- **rAEE** uses the rate of change at input 1 in degrees per minute.

AL3 This prompt appears only on controllers equipped with output 3 hardware for a relay (98____-B____, 98____-J____ or 98____-K____) or switched dc (98____-C____), and with **0E3** set to **AL3** or **AL3n**.

Default



Pr1	dE1	Pr2	dE2	rAEE	no
AL3	AL3	AL3	AL3	AL3	AL3

A35d

Alarm 3 Side

Select what triggers alarm 3.

- **both** triggers an alarm when the signal \leq **A3L0** or \geq **A3H1**.
- **H,9H** triggers an alarm when the signal \geq **A3H1**.
- **L0LJ** triggers an alarm when the signal \leq **A3L0**.

NOTE:
See Chapter 7 for more information on alarms.

A35d This prompt appears only on controllers equipped with output 3 hardware for a relay (98_ _ _ _ _B_ _ _ , 98_ _ _ _ _J_ _ _ or 98_ _ _ _ _K_ _ _) or switched dc (98_ _ _ _ _C_ _ _) and with **0E3** set to **AL3** or **AL3n**.

Default



both	H,9H	L0LJ
A35d	A35d	A35d

H453

Hysteresis 3

Select the switching hysteresis for alarm 3. This determines the change in temperature or process units needed to turn the output from off to on.

- If **AL3** is set to **rAEE** settings for **H453** will be in degrees per minute or units per minute.
- If the input referenced by **AL3** is set to **rLd** the range is affected as listed below.

H453 This prompt appears only on controllers equipped with output 3 hardware for a relay (98_ _ _ _ _B_ _ _ , 98_ _ _ _ _J_ _ _ or 98_ _ _ _ _K_ _ _) or switched dc (98_ _ _ _ _C_ _ _).

If ↓	Default ↓			
oF C_F (Global Menu)	1 ... 3 ... 999 H453 H453 H453			
oF C_F (Global Menu)	& rLd Input 1 or 2 (see note above)	0.1 ... 30 ... 999 H453 H453 H453		
oC C_F (Global Menu)		1 ... 2 ... 555 H453 H453 H453		
oC C_F (Global Menu)	& rLd Input 1 or 2 (see note above)	0.1 ... 2.0 ... 555 H453 H453 H453		
a process input is selected		1 ... 3 ... 999 H453 H453 H453		units

L A L 3

Latching 3

Select whether alarm 3 will be latching or non-latching. A latching alarm **LAL** must be turned off manually. A non-latching alarm **nLA** turns off when an alarm condition no longer exists.

LAL3 This prompt appears only on controllers equipped with output 3 hardware for a relay (98_--_--_--B_--_, 98_--_--_--J_--_ or 98_--_--_--K_--_) or switched dc (98_--_--_--C_--_) and with **DEL3** set to **AL3** or **AL3n**.

NOTE:
See Chapter 7 for more information on alarms.

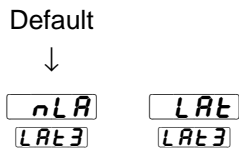

S I L 3

Silencing 3

Select silencing to inhibit alarm 3 on startup and to allow the operator to reset the alarm output, not the visual display.

- Silencing disables the alarm until the signal is between **ASLO** and **ASHI**.

SIL3 This prompt appears only on controllers equipped with output 3 hardware for a relay (98_--_--_--B_--_, 98_--_--_--J_--_ or 98_--_--_--K_--_) or switched dc (98_--_--_--C_--_) and with **DEL3** set to **AL3** or **AL3n**.

NOTE:
See Chapter 7 for more information on alarms.

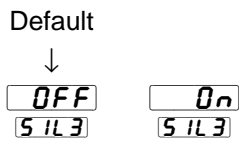

0E4

Output 4

Select the alarm condition for output 4.

- **AL4** de-energizes output 4 in an alarm condition.
- **AL4n** energizes output 4 in an alarm condition.

0E4 This prompt appears only on controllers equipped with output 4 hardware for a relay (98_ _ _ _ _B_ , 98_ _ _ _ _D_ , 98_ _ _ _ _E_ or 98_ _ _ _ _K_) or switched dc (98_ _ _ _ _C_).

NOTE:
See Chapter 7 for more information on alarms.

Default



<input type="checkbox"/> AL4	<input type="checkbox"/> AL4n
<input type="checkbox"/> 0E4	<input type="checkbox"/> 0E4

AL4

Alarm 4

Select the alarm type for alarm 4.

- **Pr1** uses a process signal from input 1.
- **dE1** uses a deviation from the input 1 signal.
- **Pr2** uses the process signal from input 2. This prompt does not appear if the controller is not equipped with input 2 hardware or if **In2** is set to **no** or **E12**.
- **dE2** uses a deviation from the input 2 signal. This prompt does not appear if the controller is not equipped with input 2 hardware or if **In2** is set to **no** or **E12**.
- **rAEE** uses the rate of change at input 1 in degrees per minute.

AL4 This prompt appears only on controllers equipped with output 4 hardware for a relay (98_ _ _ _ _B_ , 98_ _ _ _ _D_ , 98_ _ _ _ _E_ or 98_ _ _ _ _K_) or switched dc (98_ _ _ _ _C_).

Default



<input type="checkbox"/> Pr1	<input type="checkbox"/> dE1	<input type="checkbox"/> Pr2	<input type="checkbox"/> dE2	<input type="checkbox"/> rAEE	<input type="checkbox"/> no
<input type="checkbox"/> AL4	<input type="checkbox"/> AL4	<input type="checkbox"/> AL4	<input type="checkbox"/> AL4	<input type="checkbox"/> AL4	<input type="checkbox"/> AL4

A45d

Alarm 4 Side

Select what triggers alarm 4.

- **both** triggers an alarm when the signal \leq **A4LO** or \geq **A4HI**.
- **HIGH** triggers an alarm when the signal \geq **A4HI**.
- **LOW** triggers an alarm when the signal \leq **A4LO**.

NOTE:
See Chapter 7 for more information on alarms.

A45d This prompt appears only on controllers equipped with output 4 hardware for a relay (98_ _ _ _ _B_ , 98_ _ _ _ _D_ , 98_ _ _ _ _E_ or 98_ _ _ _ _K_) or switched dc (98_ _ _ _ _C_) and with **DE4** set to **AL4** or **AL4n**.

Default



b0EH	H19H	L0LJ
A45d	A45d	A45d

H454

Hysteresis 4

Select the switching hysteresis for alarm 4. This determines the change in temperature or process units needed to turn the output from off to on.

- If **AL4** is set to **rAEE** settings for **H454** will be in degrees per minute or units per minute.
- If the input referenced by **AL4** is set to **rEd** the range is affected as listed below.

H454 This prompt appears only on controllers equipped with output 4 hardware for a relay (98_ _ _ _ _ B_ , 98_ _ _ _ _ D_ , 98_ _ _ _ _ E_ or 98_ _ _ _ _ K_) or switched dc (98_ _ _ _ _ C_).

If ↓	Default ↓
<div style="border: 1px solid black; padding: 2px; display: inline-block;">oF</div> <div style="border: 1px solid black; padding: 2px; display: inline-block;">c.F</div> (Global Menu)	<div style="border: 1px solid black; padding: 2px; display: inline-block;">_ ... _ 3 ... 999</div> <div style="border: 1px solid black; padding: 2px; display: inline-block;">H454 H454 H454</div>
<div style="border: 1px solid black; padding: 2px; display: inline-block;">oF</div> <div style="border: 1px solid black; padding: 2px; display: inline-block;">c.F</div> (Global Menu)	& rEd Input 1 or 2 (see note above)
<div style="border: 1px solid black; padding: 2px; display: inline-block;">0.1</div> ... <div style="border: 1px solid black; padding: 2px; display: inline-block;">3.0</div> ... <div style="border: 1px solid black; padding: 2px; display: inline-block;">999</div> <div style="border: 1px solid black; padding: 2px; display: inline-block;">H454 H454 H454</div>	
<div style="border: 1px solid black; padding: 2px; display: inline-block;">oC</div> <div style="border: 1px solid black; padding: 2px; display: inline-block;">c.F</div> (Global Menu)	<div style="border: 1px solid black; padding: 2px; display: inline-block;">_ ... _ 2 ... 555</div> <div style="border: 1px solid black; padding: 2px; display: inline-block;">H454 H454 H454</div>
<div style="border: 1px solid black; padding: 2px; display: inline-block;">oC</div> <div style="border: 1px solid black; padding: 2px; display: inline-block;">c.F</div> (Global Menu)	& rEd Input 1 or 2 (see note above)
<div style="border: 1px solid black; padding: 2px; display: inline-block;">0.1</div> ... <div style="border: 1px solid black; padding: 2px; display: inline-block;">2.0</div> ... <div style="border: 1px solid black; padding: 2px; display: inline-block;">555</div> <div style="border: 1px solid black; padding: 2px; display: inline-block;">H454 H454 H454</div>	
<div style="border: 1px solid black; padding: 2px; display: inline-block;">_ ... _ 3 ... 999</div> <div style="border: 1px solid black; padding: 2px; display: inline-block;">H454 H454 H454</div>	units

a process input is selected

L4E4

Latching 4

Select whether alarm 4 will be latching or non-latching. A latching alarm **LAE** must be turned off manually. A non-latching alarm **nLA** turns off when an alarm condition no longer exists.

L4E4 This prompt appears only on controllers equipped with output 4 hardware for a relay (98_ _ _ _ _ B_ , 98_ _ _ _ _ J_ or 98_ _ _ _ _ K_) or switched dc (98_ _ _ _ _ C_). and with **OE4** set to **AL4** or **AL4n**.

NOTE:
See Chapter 7 for more information on alarms.

Default ↓
<div style="border: 1px solid black; padding: 2px; display: inline-block; margin-right: 20px;">nLA</div> <div style="border: 1px solid black; padding: 2px; display: inline-block;">LAE</div>
<div style="border: 1px solid black; padding: 2px; display: inline-block; margin-right: 20px;">L4E4</div> <div style="border: 1px solid black; padding: 2px; display: inline-block;">L4E4</div>

SIL4

Silencing 4

Select silencing to inhibit alarm 4 on startup and to allow the operator to reset the alarm output, not the visual display.

- Silencing disables the alarm until the signal is between **AL4D** and **AL4I**.

NOTE:
See Chapter 7 for more information on alarms.

SIL4 This prompt appears only on controllers equipped with output 4 hardware for a relay (98_ _ _ _ _B_ , 98_ _ _ _ _D_ , 98_ _ _ _ _E_ or 98_ _ _ _ _K_) or switched dc (98_ _ _ _ _C_) and with **OLE4** set to **AL4** or **AL4n**.

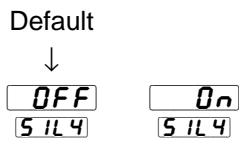

Rout

Analog Output

Select which value to retransmit as the output 3 signal.

- **Prc1** retransmits the process 1 value.
- **SEPt** retransmits the set point.
- **Prc2** retransmits the process 2 value. This prompt appears only if the controller is equipped with input 2 hardware and if **in2** is not set to **no** or **Ei2**.
- **no** turns off retransmit function.

NOTE:
See Chapter 8 for more information on retransmit.

Rout This prompt appears only on controllers equipped with retransmit hardware (98_ _ _ _ _M_ _ _ or 98_ _ _ _ _N_ _ _).

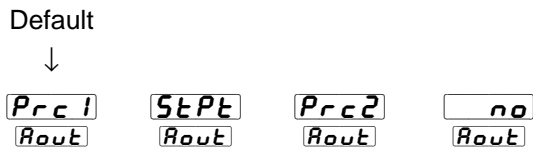

Prc3

Process 3

Select the range for the retransmit signal at output 3.

Prc3 This prompt appears only on controllers equipped with retransmit hardware (98____-M____ or 98____-N____) and with **Rout** not set to **no**.

Default



4-20mA	0-20mA	0-5V _{rms}	1-5V _{rms}	0-10V _{rms} (dc)
4-20	0-20	0-5	1-5	0-10
Prc3	Prc3	Prc3	Prc3	Prc3

RrL

Retransmit Low Limit

Select the low limit for the retransmit signal at output 3.

- The **default** value is equal to **rL1** or **rL2** (in the Input Menu) depending on whether **Rout** is set to **Prc1** or **Prc2**.
- The decimal precision of **RrL** is determined by **dEC1** (Input Menu) if **Rout** is set to **Prc1** or **SEPT**; it is determined by **dEC2** if **Rout** is set to **Prc2**.

RrL This prompt appears only on controllers equipped with retransmit hardware (98____-M____ or 98____-N____) and with **Rout** not set to **no**.

-999 ... **RrH**
RrL **RrL**

NOTE:
 See Chapter 8 for more information on retransmit.

A rH

Retransmit High Limit

Select the high limit for the retransmit signal at output 3.

- The **default** value is equal to **rH1** or **rH2** (in the Input Menu) depending on whether **Route** is set to **Prc1** or **Prc2**.
- The decimal precision of **ACAL** is determined by **DEC1** (Input Menu) if **Route** is set to **Prc1** or **SEPE**; it is determined by **DEC2** if **Route** is set to **Prc2**.

A rH This prompt appears only on controllers equipped with retransmit hardware (98_ _ _ _ _-M_ _ _ or 98_ _ _ _ _-N_ _ _) and with **Route** not set to **no**.

A rL ... **9999**
A rH **A rH**

ACAL

Retransmit Calibration Offset

Select an offset value for the retransmit signal at output 3.

- The decimal precision of **ACAL** is determined by **DEC1** (Input Menu) if **Route** is set to **Prc1** or **SEPE**; it is determined by **DEC2** if **Route** is set to **Prc2**.

ACAL This prompt appears only on controllers equipped with retransmit hardware (98_ _ _ _ _-M_ _ _ or 98_ _ _ _ _-N_ _ _) and with **Route** not set to **no**.

NOTE:
 See Chapter 8 for more information on retransmit.

If ↓	Default ↓
oF C_F (Global Menu)	-999 ... 0 ... 999 ACAL ACAL ACAL
oC C_F (Global Menu)	-555 ... 0 ... 555 ACAL ACAL ACAL
a process input is selected	-999 ... 0 ... 999 units ACAL ACAL ACAL

Setup-Global

Reaching the Global Menu

1 Begin in the Display Loop, and press the Up-arrow and Down-arrow keys simultaneously for three seconds to reach the Setup Menu.

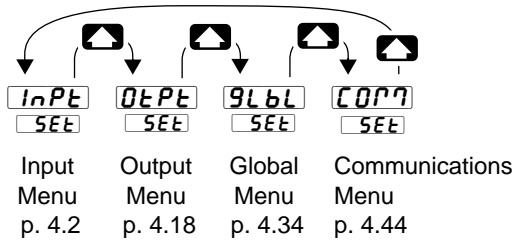

2 Press the Up-arrow key to select one of the Setup Menus.

3 Press the Mode key to step through the prompts.

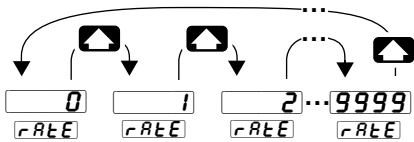
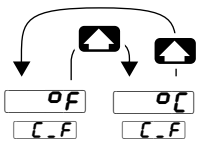

4 Press the Up-arrow key or the Down-arrow key to select one of the prompt values.

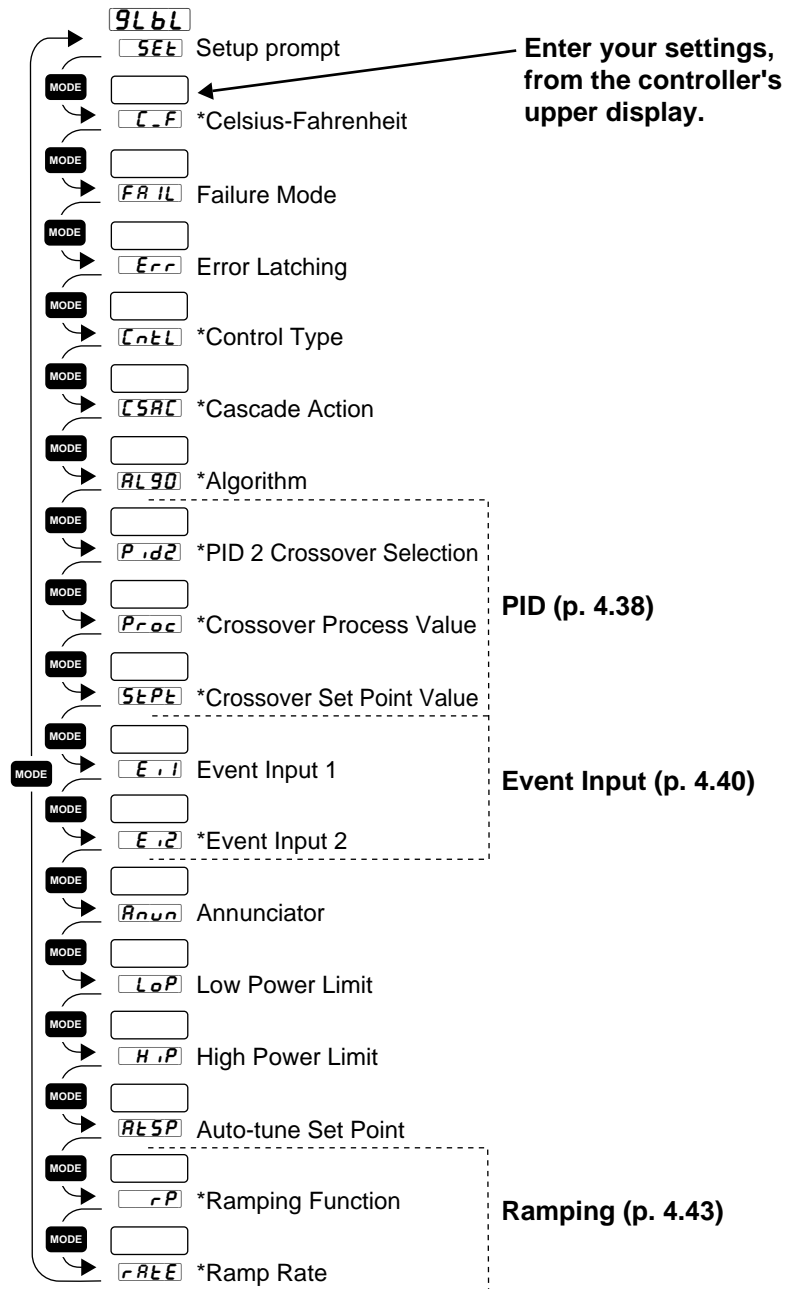

*Prompts may not appear, depending on controller configuration.

Figure 4.34 - Navigating the Global Menu.

Global Prompts

NOTE:
 Decimal points may not always be in the position specified below depending on the the settings in the Decimal 1 `DEC1` and Decimal 2 `DEC2` parameters in the Input Menu.



When you are in the Setup menus, the Series 988 displays the menu selection (`INPT`, `DEPT`, `GLBL` or `COPY`) in the upper display, and `SEE` in the lower display.

The Up-arrow or Down-arrow key selects another menu. Press the Mode key `MODE` to display the first prompt in the lower display and its value in the upper display. Use the Up-arrow and Down-arrow keys to change the value in the upper display. The new value will not take effect until after a five-second delay or until you press the Mode key `MODE`.

Celsius-Fahrenheit

Select which temperature scale the controller will use.

`C_F` This prompt appears only on controllers with either Input 1 or Input 2 set to something other than a process input.

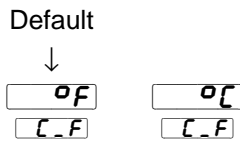

Failure Mode

Select the output level that the controller will maintain if an input fails.

- Bumpless transfer `bPLS` maintains the same output settings after an input failure.

`FAIL` This prompt always appears.

If	Default	
a heat/cool application	<code>bPLS</code> <code>FAIL</code>	<code>-100</code> ... <code>100</code> % <code>FAIL</code> ... <code>FAIL</code>
a heat-only application	<code>bPLS</code> <code>FAIL</code>	<code>0</code> ... <code>100</code> % <code>FAIL</code> ... <code>FAIL</code>
a cool-only application	<code>bPLS</code> <code>FAIL</code>	<code>-100</code> ... <code>0</code> % <code>FAIL</code> ... <code>FAIL</code>

Err

Error Latching

Select whether errors will be latching or non-latching.

- Non-latching alarms **nLA** turn off when there is no alarm condition.
- Latching alarms **LAL** must be turned off manually.

Err This prompt always appears.

Default



nLA	LAL
Err	Err

Ctrl

Control Type

Select a control method: normal **nor**; cascade **CSCd**; ratio **rAt i**; or differential **d iFF**.

Ctrl This prompt appears only on controllers equipped with enhanced software (98_B-____-____) and input 2 hardware for a basic thermocouple signal conditioner (98__-1__-____) or a universal signal conditioner (98__-2__-____) and with **rSP** set to **OFF**.

Default



nor	CSCd	rAt i	d iFF
Ctrl	Ctrl	Ctrl	Ctrl

CSAC

Cascade Action

Select the control action between the inner and outer loop of a cascade system.

- Direct action **dir** makes the percent output from the outer loop directly proportional to the set point of the inner loop (input 2). A 100% signal in the outer loop will set the inner loop to range high 2 **rH2** (Input Menu). A 0% signal in the outer loop will set the inner loop to range low 2 **rL2** (Input Menu).
- Reverse action **rev** makes the percent output from the outer loop inversely proportional to the set point of the inner loop (input 2). A 100% signal in the outer loop will set the inner loop to range low 2 **rL2** (Input Menu). A 0% signal in the outer loop will set the inner loop to range high 2 **rH2** (Input Menu).

CSAC This prompt appears only on controllers equipped with enhanced software (98_B-_-_-_-_) and with **cntl** set to **SCd**.

Default



AL90

Algorithm

Select the control algorithm.

- **P_{id}** selects one set of PID prompts.
- **P_{dr}** selects proportional/derivative control with manual reset in percent power.
- **P_{id2}** selects two complete sets of PID prompts. This selection does not appear if **CTL** is set to **SCD**.
- **DUPL** selects duplex (heating and cooling) control. This prompt does not appear unless output 1 is a process output.

AL90 This prompt appears only on controllers equipped with enhanced software (98_B-____-____).

Default



<input type="checkbox"/> P_{id}	<input type="checkbox"/> P_{dr}	<input type="checkbox"/> P_{id2}	<input type="checkbox"/> DUPL
AL90	AL90	AL90	AL90

PID 2 Crossover Selection

P_{id2}

Select which parameter determines the crossover from PID A to PID B: process **Proc**; set point **SEPt**; or none **no**.

P_{id2} This prompt appears only on controllers with **AL90** set to **P_{id2}**.

Default



<input type="checkbox"/> Proc	<input type="checkbox"/> SEPt	<input type="checkbox"/> no
P_{id2}	P_{id2}	P_{id2}

Proc

Crossover Process Value

Select the process value at which the control algorithm will crossover between PID A and PID B. PID A is active below this value and PID B is active above this value.

- This value cannot be set lower than range low 1 `rL1` or higher than range high 1 `rH1`.

`Proc` This prompt appears only on controllers with `Pid2` set to `Proc`.



SEPt

Crossover Set Point Value

Select the set point value at which the control algorithm will crossover between PID A and PID B. PID A is active below this value and PID B is active above this value.

- This value cannot be set lower than range low 1 `rL1` or higher than range high 1 `rH1`.

`SEPt` This prompt appears only on controllers with `Pid2` set to `SEPt`.



E , 1

Event Input 1

Select the effect of closing the event input 1 switch.

- **no** disables event input 1.
 - **LOC** locks out the front panel keys.
 - **ALr** resets an alarm.
 - **A-P7** switches the controller to manual mode at the power level set at **FRIL** (Global Menu) and disables the Auto/Man  key.
 - **OFF** turns all control outputs off (de-energize relays).
 - **P id** switches from PID A to PID B.
 - **Actn** selects the opposite control action for output 1 and 2.
 - **rSP** switches to a remote set point.
 - **IdSP** switches to an idle or second set point.
- E , 1** This prompt always appears.

Default



no	LOC	ALr	A-P7	OFF	P id	Actn	rSP	IdSP
E , 1	E , 1	E , 1	E , 1	E , 1	E , 1	E , 1	E , 1	E , 1

E , 2

Event Input 2

Select the effect of closing the event input 2 switch. The selections are the same as for event input 1.

E , 2 This prompt appears only on controllers equipped with hardware for a second event input (98__-5__-__-__) and with **In2** set to **E , 2**.

Default



no	LOC	ALr	A-P7	OFF	P id	Actn	IdSP
E , 2	E , 2	E , 2	E , 2	E , 2	E , 2	E , 2	E , 2

Annun

Annunciator

Select whether alarm messages will flash in the lower display.

Annun This prompt always appears.

Default



<input type="checkbox"/> on	<input type="checkbox"/> OFF
Annun	Annun

LoP

Low Power Limit

Select the low limit for the percent output. For cooling (direct acting) enter a negative number.

LoP This prompt always appears.

If ↓	Default ↓	
a heat/cool application	<input type="checkbox"/> - 100% ... LoP	<input type="checkbox"/> H , P LoP
a heat only application	<input type="checkbox"/> 0% ... LoP	<input type="checkbox"/> H , P LoP
a cool only application	<input type="checkbox"/> - 100% ... LoP	<input type="checkbox"/> H , P LoP

H , P

High Power Limit

Select the high limit for the percent output. For cooling (direct acting) enter a negative number.

H , P This prompt always appears.

If	Default
a heat/cool application	LoP ... 100% H , P H , P
a heat only application	LoP ... 100% H , P H , P
a cool only application	LoP ... 0% H , P H , P

ATSP

Auto-tune Set Point

Select the percentage at which the controller will auto tune the current control set point.

ATSP This prompt always appears.

Default
50 ... 90 ... 150 % ATSP ATSP ATSP

rP

Ramping Function

Select when the controller will ramp. Ramping limits the speed at which an element can heat up. Ramping is often used to protect parts that would crack or warp if they heat up too quickly.

- **OFF** sets the system to heat as quickly as possible.
- **Start** sets the system to ramp only at startup.
- **SEPT** sets the system to ramp at startup and whenever the set point changes.

rP This prompt appears only on controllers with **rSP** (Input Menu) set to **OFF** and with **ELI** not set to **rSP** and with **CTRL** (Global Menu) not set to **DIFF** or **RAE**.

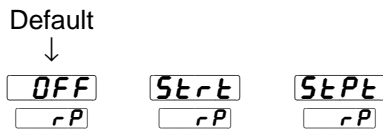

rRAE

Ramp Rate

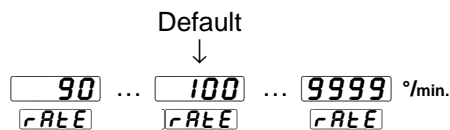

Select the ramping rate in degrees per minute.

rRAE This prompt appears only on controllers with **rP** set to **Start** or **SEPT**.



Setup-Comm

Reaching the Communications Menu

1 Begin in the Display Loop, and press the Up-arrow  and Down-arrow  keys simultaneously for three seconds to reach the Setup Menu.

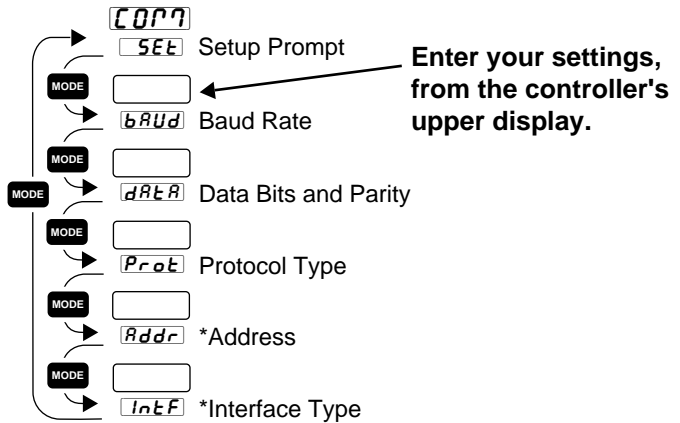
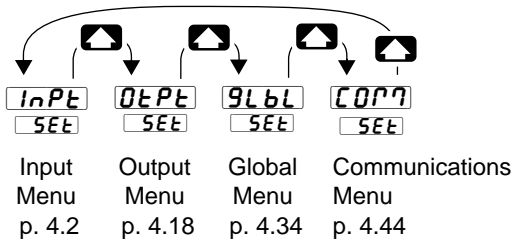

2 Press the Up-arrow key  to select one of the Setup Menus.

*Prompts may not appear, depending on controller configuration.

3 Press the Mode key  to step through the prompts.

NOTE:
The Communications Menu appears only on controllers equipped with communications hardware (98 _ _ _ _ _ R _ _ , 98 _ _ _ _ _ U _ _ or 98 _ _ _ _ _ S _ _).

See *Data Communications with the Series 988 Family of Controllers* for detailed information on communications.

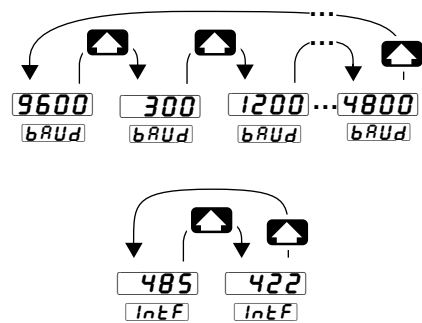







4 Press the Up-arrow key  or the Down-arrow key  to select one of the prompt values.

Figure 4.44 - Navigating the Communications Menu.

Communications Prompts

When you are in the Setup menus, the Series 988 displays the menu selection (`INPT`, `DEPT`, `GLBL` or `COMP`) in the upper display, and `SET` in the lower display.

The Up-arrow  or Down-arrow key  selects another menu. Press the Mode key `MODE` to display the first prompt in the lower display and its value in the upper display. Use the Up-arrow  and Down-arrow  keys to change the value in the upper display. The new value will not take effect until after a five-second delay or until you press the Mode key `MODE`.

`BAUD`

Baud Rate

Select the communications speed.

`BAUD` This prompt appears only on controllers equipped with communications hardware (98_ _ _ _ _ R_ , 98_ _ _ _ _ U_ or 98_ _ _ _ _ S_).

Default
↓

<code>9600</code>	<code>300</code>	<code>600</code>	<code>1200</code>	<code>2400</code>	<code>4800</code>
<code>BAUD</code>	<code>BAUD</code>	<code>BAUD</code>	<code>BAUD</code>	<code>BAUD</code>	<code>BAUD</code>

`DATA`

Data Bits and Parity

Select the communications format (start bit = 1, stop bit = 1).

- Setting `PROT` to `MOD` automatically sets `DATA` to `8n`.

`DATA` This prompt appears only on controllers equipped with communications hardware (98_ _ _ _ _ R_ , 98_ _ _ _ _ U_ or 98_ _ _ _ _ S_).

Default
↓

<code>7a</code>	<code>7E</code>	<code>8n</code>
<code>DATA</code>	<code>DATA</code>	<code>DATA</code>

Prot

Protocol Type

Select the communications protocol.

- **FULL** selects ANSI X3.28 2.2 - A.3.
- **on** selects Xon/Xoff.
- **Mod** selects Modbus

Prot This prompt appears only on controllers equipped with communications hardware (98_ _ _ _ _ R_ _ , 98_ _ _ _ _ U_ _ or 98_ _ _ _ _ S_ _).

Default



FULL
Prot

on
Prot

Mod
Prot

Addr

Address

Select an address for the controller. The computer will use this address when communicating with this controller.

Addr This prompt appears only on controllers equipped with communications hardware for EIA/TIA-485 and EIA/TIA-422.

If



485
IntF

422
IntF

Mod
IntF

Default



0...**31**
Addr Addr

0...**9**
Addr Addr

0...**1**...**247**
Addr Addr Addr

IntF

Interface Type

Select the interface type for Output 4, Option S.

- **485** selects EIA/TIA-485.
- **422** selects EIA/TIA-422.

IntF This prompt appears only on controllers equipped with communications hardware for EIA/TIA-485 and EIA/TIA-422 (98_ _- _ _ _ _- _S_ _).

Default



<input type="checkbox"/> 485	<input type="checkbox"/> 422
<input type="checkbox"/> IntF	<input type="checkbox"/> IntF

IntF

Interface Type

Select the interface type for Output 4, Option U.

- **485** selects EIA/TIA-485.
- **232** selects EIA/TIA-232.

IntF This prompt appears only on controllers equipped with communications hardware for EIA/TIA-485 and EIA/TIA-232 (98_ _- _ _ _ _- _U_ _).

Default



<input type="checkbox"/> 232	<input type="checkbox"/> 485
<input type="checkbox"/> IntF	<input type="checkbox"/> IntF

Chapter 5 The Operation Menus

Navigating the Operation Menus

To reach the Operation Menus, begin in the Display Loop and press the Mode key **MODE**. Depending on the controller configuration, either the Set Point 2 prompt **SP2**, the Idle Set Point prompt **IdSP** or the Operation Menu prompt **OPER** will appear in the lower display. The three Operation Menus are: System **SYS**; PID A **PIdA**; and PID B **PIdB**. Use the Mode key **MODE** to step past the Set Point 2 prompt **SP2** or the Idle Set Point prompt **IdSP**, if they appear (see prompt information). Upon reaching the Operation Menu prompt **OPER** use the Up-arrow **▲** or Down-arrow **▼** key to select a menu and the Mode key **MODE** to step through a menu.

NOTE:
Press the Display key **DISPLAY** to return to the Display Loop from any point in any menu.

You will not see every prompt in any of these menus. The unit's configuration and model number determine which prompts appear. After stepping through each menu, the Series 988 returns to the Operation Menu prompt **OPER**. Use the Up-arrow **▲** and Down-arrow **▼** keys to select the next menu, or use the Mode key **MODE** to advance through the same menu again. To move backwards through the menu hold the Mode key **MODE** down and press the Up-arrow key **▲**. Use the Up-arrow **▲** or Down-arrow **▼** key to change the prompt setting.



1 Begin in the Display Loop, and press the Mode key **MODE** to reach the Set Point 2 prompt **SP2**, the Idle Set Point prompt **IdSP** or the Operation Menu **OPER**.

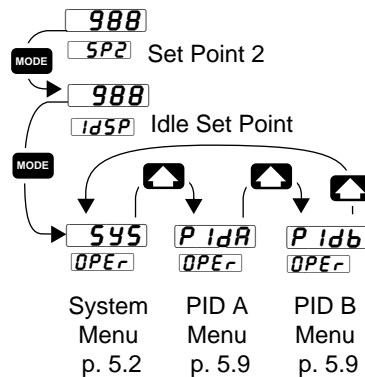

2 Use the Mode key **MODE** to step past the Set Point 2 prompt **SP2** or the Idle Set Point prompt **IdSP**, if they appear (see prompt information). Upon reaching the Operation Menu prompt **OPER** use the Up-arrow **▲** key to select a menu.

Figure 5.1 - Navigating the Operation Menus.

Operation-System

Reaching the System Menu



3 Select the System Menu, then press the Mode key **MODE** to step through the prompts.

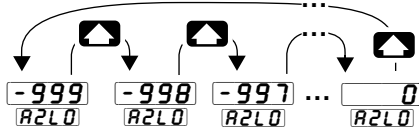

4 Press the Up-arrow key to step through the prompt values. The Down-arrow key backs through the values.

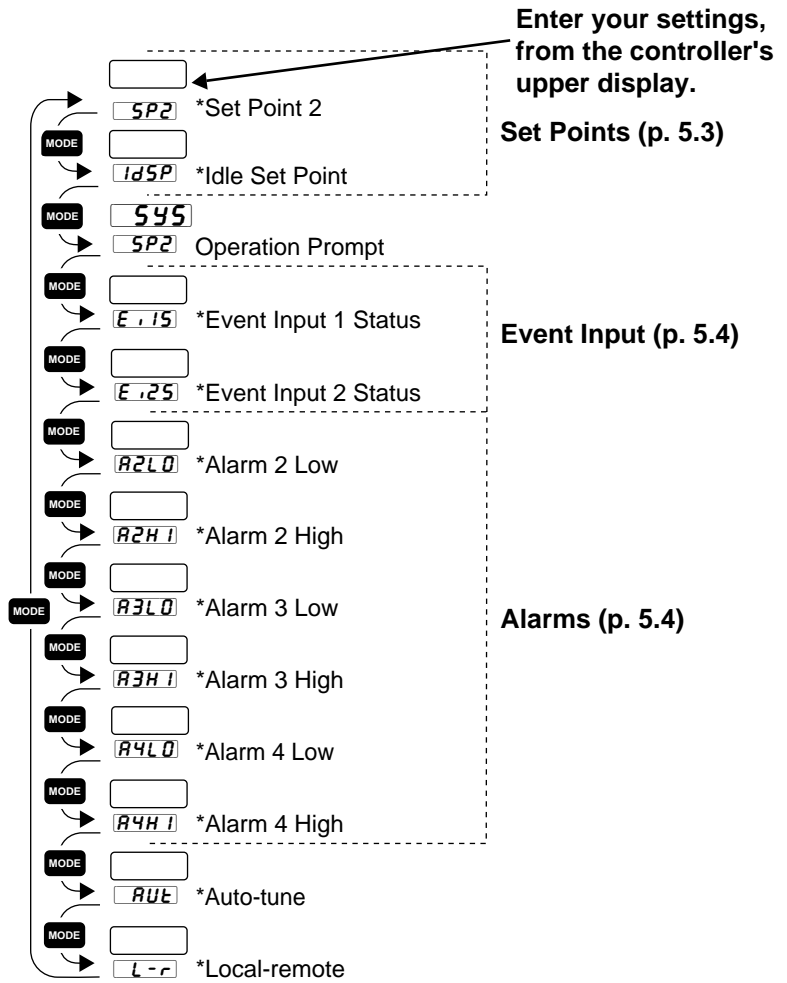

*Prompts may not appear, depending on controller configuration.

Figure 5.2 - The System Menu.





System Prompts

NOTE:

Decimal points may not always be in the position specified below depending on the the settings in the Decimal 1 `DEC1` and Decimal 2 `DEC2` parameters in the Input Menu.

`SP2`

After you step past the Set Point 2 prompt `SP2` and the Idle Set Point prompt `IdSP` to the Operation menus, the Series 988 displays the menu selection (`SY5`, `P,IdA` or `P,IdB`) in the upper display and `OPER` in the lower display.

The Up-arrow  or Down-arrow key  selects another menu. Press the Mode key `MODE` to display the first prompt in the lower display and its value in the upper display. Use the Up-arrow  and Down-arrow  keys to change the value in the upper display. The new value will not take effect until after a five-second delay or until you press the Mode key `MODE`.

Set Point 2

Select a second set point that will activate output 2. This allows you to boost the heating or cooling action of the output 1 device.

- The **range and default settings** depend on the `In1`, `rL1` and `rH1` settings (Input Menu).

`SP2` This prompt appears only if `Out1` and `Out2` (Output Menu) are both set to `HE` or `CL`.

`rL1` ... `rH1`
`SP2` `SP2`

`IdSP`

Idle Set Point

Select the set point to be activated by an event input. This allows you to select a temperature that will be maintained when the application is idle.

- The **range and default settings** depend on the `In1`, `rL1` and `rH1` settings (Input Menu).

`IdSP` This prompt appears only if `E,1` or `E,2` (Global Menu) is set to `IdSP`.

`rL1` ... `rH1`
`IdSP` `IdSP`

E,15

Event Input 1 Status

Indicates whether the event input 1 circuit is open or closed (read only).

E,15 This prompt appears only if **E,1** (Global Menu) is set to something other than **no**.

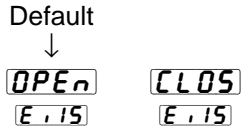

E,25

Event Input 2 Status

Indicates whether the event input 2 circuit is open or closed (read only).

E,25 This prompt appears only on controllers equipped with a second digital event input (98_ _5_ _ _ _) and with **E,2** (Global Menu) set to something other than **no**.

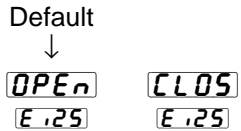

A2LO

Alarm 2 Low

Select the low trigger value for the output 2 alarm.

A2LO This prompt appears only if **AL2** (Output Menu) is set to something other than **no**.

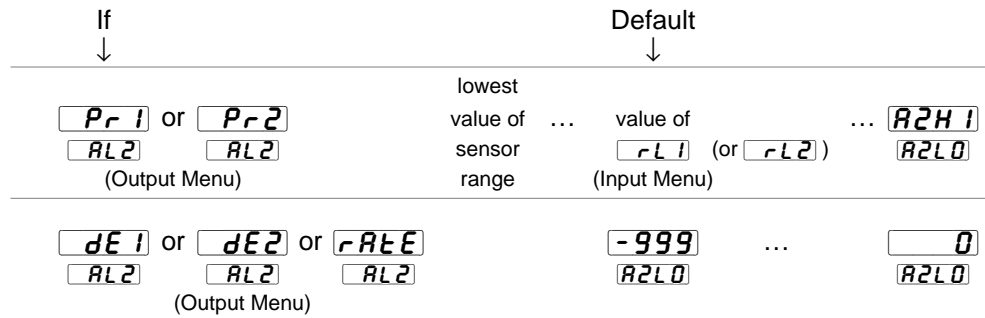

A3H1

Alarm 3 High

Select the high trigger value for the output 3 alarm.

A3H1 This prompt appears only if **AL3** (Output Menu) is set to something other than **no**.

If ↓	Default ↓	
Pr1 or Pr2 AL3 AL3 (Output Menu)	A3L0 ... value of ... A3H1 AL3 AL3 AL3 AL3 AL3 ... (Input Menu)	highest ... value of sensor range
dE1 or dE2 or rALe AL3 AL3 AL3 AL3 AL3 AL3 (Output Menu)	0 ... 999 ... 9999 A3H1 A3H1 A3H1 A3H1	

Alarm 4 Low

A4L0

Select the low trigger value for the output 4 alarm.

A4L0 This prompt appears only if **AL4** (Output Menu) is set to something other than **no**.

If ↓	Default ↓	
Pr1 or Pr2 AL4 AL4 (Output Menu)	lowest value of ... sensor range	value of ... AL4 AL4 AL4 AL4 AL4 AL4 ... (Input Menu)
dE1 or dE2 or rALe AL4 AL4 AL4 AL4 AL4 AL4 (Output Menu)	-999 ... 0 A4L0 A4L0 A4L0 A4L0	

A4H1

Alarm 4 High

Select the high trigger value for the output 4 alarm.

A4H1 This prompt appears only if **AL4** (Output Menu) is set to something other than **no**.

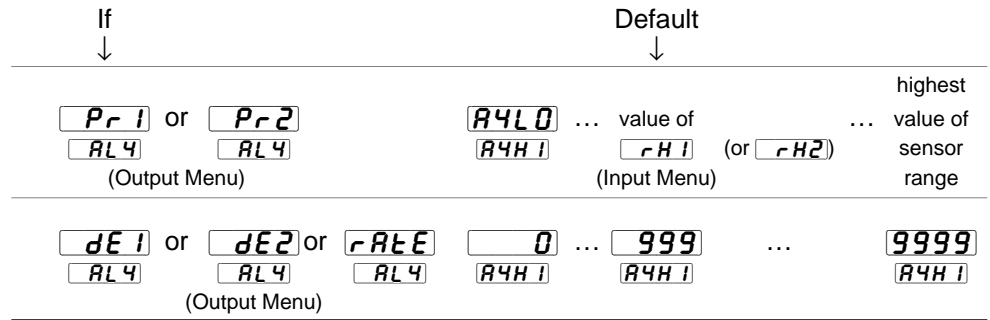

AUT

Auto-tune

Initiate an auto-tune.

P ,db appears only on controllers with enhanced software (98_B-_-_-_-_-_-_-_-_-_-) and with **AL90** (Global Menu) set to **P ,d2** or **c5cd**.

AUT This prompt always appears.

NOTE:
For more information on auto-tune see Chapter 7.



Operation-System

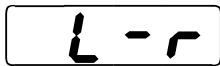

Local-remote

Select a local or remote set point. With selected the controller displays the remote set point rather than the internal (local) set point, and the set point cannot be changed with the Up-arrow or Down-arrow key.

This prompt appears only if (Input Menu) is set to .

Default



Reaching the PID Menus

1 Begin in the Display Loop, and press the Mode key **MODE** to reach the Set Point 2 prompt **SP2**, the Idle Set Point prompt **IdSP** or the System Menu **555**.

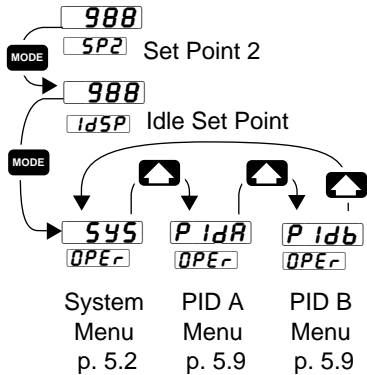

2 Use Mode key **MODE** to step past the Set Point 2 prompt **SP2** and the Idle Set Point prompt **IdSP**, if they appear (see prompt information). Upon reaching the Operation Menu prompt **OPER** use the Up-arrow **▲** key to select a menu.

3 Press the Mode key **MODE** to step through the prompts.

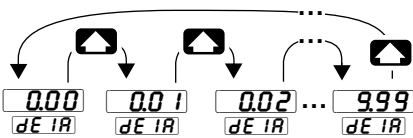

4 Press the Up-arrow key **▲** to step through the prompt values. The Down-arrow key **▼** backs through the values.

Figure 5.9 - The PID Menu.

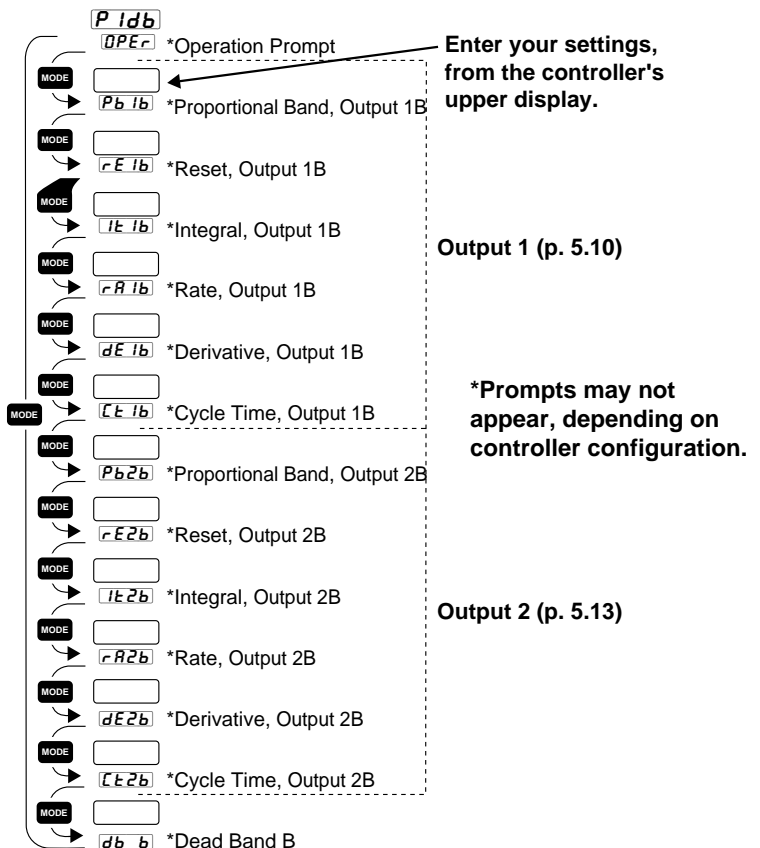
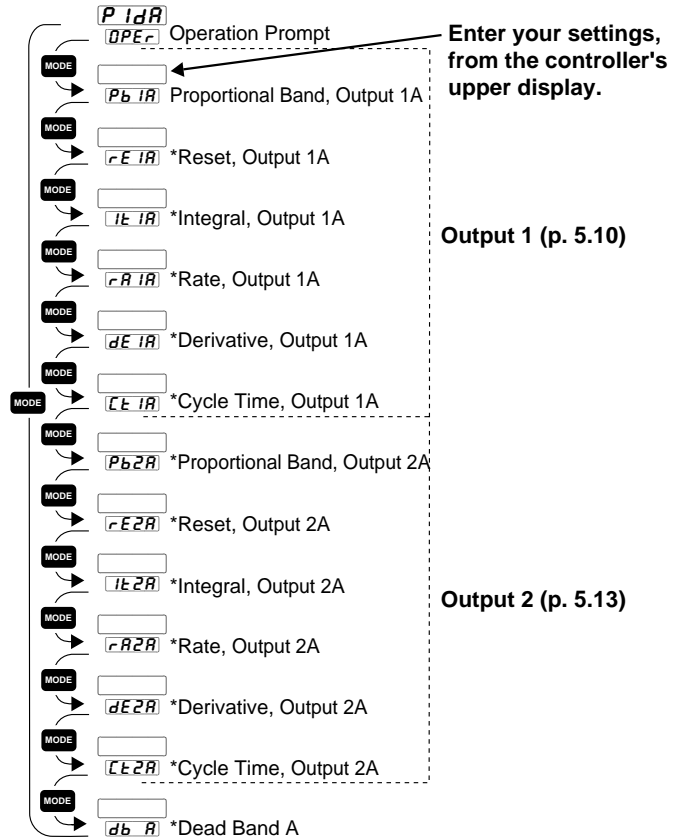





Operation-PID A or B

PID A or PID B Prompts

NOTE:

Decimal points may not always be in the position specified below depending on the the settings in the Decimal 1 `dEC1` and Decimal 2 `dEC2` parameters in the Input Menu.

After you step past the Set Point 2 prompt `SP2` and the Idle Set Point prompt `IdSP` to the Operation menu, the Series 988 displays the menu selection (`SP2`, `PIdA` or `PIdB`) in the upper display and `OPER` in the lower display.

The Up-arrow  or Down-arrow key  selects another menu. Press the Mode key `MODE` to display the first prompt in the lower display and its value in the upper display. Use the Up-arrow  and Down-arrow  keys to change the value in the upper display. The new value will not take effect until after a five-second delay or until you press the Mode key `MODE`.

`Pb 1A`

`Pb 1B`

Proportional Band, Output 1A or 1B

Select the proportional band for PID output 1. If set to `0` it functions as an on/off control, and the switching differential is determined by the `HYS1` value (Output Menu). The decimal precision is determined by `dEC1` (Input Menu).

`Pb 1A` This prompt always appears.

NOTE:

The PID B Menu appears only on controllers with enhanced software (98_B-____-____) and with `RL90` set to `PId2`.

If		Default
↓	<code>US</code> & <code>OF</code> <code>dFL</code> <code>C_F</code>	<code>0</code> ... <code>25</code> ... <code>9999</code> <code>Pb 1A</code> <code>Pb 1A</code> <code>Pb 1A</code>
	(Calibration Menu)(Global Menu)	
	& <code>rt.d</code> Input 1 or 2 (Input Menu)	<code>00</code> ... <code>25</code> ... <code>9999</code> <code>Pb 1A</code> <code>Pb 1A</code> <code>Pb 1A</code>
	(Input Menu)	
	<code>US</code> & <code>OC</code> <code>dFL</code> <code>C_F</code>	<code>0</code> ... <code>14</code> ... <code>9999</code> <code>Pb 1A</code> <code>Pb 1A</code> <code>Pb 1A</code>
	(Calibration Menu)(Global Menu)	
	& <code>rt.d</code> Input 1 or 2 (Input Menu)	<code>00</code> ... <code>14</code> ... <code>9999</code> <code>Pb 1A</code> <code>Pb 1A</code> <code>Pb 1A</code>
	(Input Menu)	
	<code>S1</code> & <code>PId2</code> <code>dFL</code> <code>RL90</code>	<code>00</code> ... <code>30</code> ... <code>9999</code> % of span <code>Pb 1A</code> <code>Pb 1A</code> <code>Pb 1A</code>
	(Calibration Menu) (Global Menu)	

rE 1A

rE 1B

Reset, Output 1A or 1B

Tune reset to eliminate the offset or droop between the set point and the actual process temperature for PID output 1. When set to reset is disabled.

rE 1A This prompt appears only if **dFL** (Calibration Menu) is set to **US** and **Pb 1A** is not set to .

If	Default
↓	↓
	<input type="text" value="0000"/> ... <input type="text" value="9999"/> repeats/min. rE 1A rE 1A
Pdr AL90 (Global Menu)	<input type="text" value="-1000"/> % ... <input type="text" value="00"/> % ... <input type="text" value="1000"/> % rE 1A rE 1A rE 1A

1I 1A

1I 1B

Integral, Output 1A or 1B

Tune integral to eliminate the offset or droop between the set point and the actual process temperature for PID output 1. When set to integral is disabled.

1I 1A This prompt appears only if **dFL** (Calibration Menu) is set to **S1** and **Pb 1A** is not set to .

NOTE:
The PID B Menu appears only on controllers with enhanced software (98_B-____-____).

Default
↓
<input type="text" value="000"/> ... <input type="text" value="9999"/> min. / repeat 1I 1A 1I 1A

Operation-PID A or B

rA 1A

rA 1B

Rate, Output 1A or 1B

Adjust the rate to eliminate overshoot on startup or after the set point changes. The rate setting will not influence the percent power if the process temperature is more than twice the proportional band from the set point. When set to rate is disabled.

This prompt appears only if (Calibration Menu) is set to and is set higher than .

Default



... min.

dE 1A

dE 1B

Derivative, Output 1A or 1B

Adjust the derivative to eliminate overshoot on startup or after the set point changes. The derivative setting will not influence the percent power if the process temperature is more than twice the proportional band from the set point. When set to derivative is disabled.

This prompt appears only if (Calibration Menu) is set to and is set higher than .

Default



... min.

NOTE:
The PID B Menu appears only on controllers with enhanced software (98_B-_____-____).

CT 1A

CT 1B

Cycle Time, Output 1A or 1B

Select the time, in seconds, of a complete on/off cycle.

CT 1A This prompt appears only if **IN 1** (Input Menu) is not set to a process, **CTRL** (Global Menu) is not set to **CSCd** and **Pb 1A** is set higher than **0**.

If ↓		Default ↓
mechanical relay outputs	5.0 ... 10.0 ... 999.9 sec. CT 1A CT 1A CT 1A	
open collector or solid-state relay outputs	brSt 0.1 ... 1.0 ... 999.9 sec. CT 1A CT 1A CT 1A	

Pb 2A

Pb 2B

Proportional Band, Output 2A or 2B

Select the proportional band for PID output 2. If set to **0** it functions as an on/off control, and the switching differential is determined by the **HYS2** value (Output Menu). Decimal precision is determined by the **dEC 1** or **dEC 2** setting (Input Menu).

Pb 2A This prompt appears only if **CTRL** (Global Menu) is not set to **CSCd** and if **DE 2** (Output Menu) is set to **HE** or **CL** or if **AL 90** (Global Menu) is set to **DUPL**.

NOTE:
The PID B Menu appears only on controllers with enhanced software (98_B- - - - -).

If ↓		Default ↓
US & oF dFL C_F (Calibration Menu) (Global Menu)	0 ... 25 ... 999.9 Pb 2A Pb 2A Pb 2A	
& rt.d Input 1 or 2 (Input Menu)	0.0 ... 25 ... 999.9 Pb 2A Pb 2A Pb 2A	
US & oC dFL C_F (Calibration Menu) (Global Menu)	0 14 ... 999.9 Pb 2A Pb 2A Pb 2A	
& rt.d Input 1 or 2 (Input Menu)	0.0 ... 14 ... 999.9 Pb 2A Pb 2A Pb 2A	
S 1 dFL (Calibration Menu)	0.0 ... 3.0 ... 999.9 % of span Pb 2A Pb 2A Pb 2A	

Operation-PID A or B

rE2A

rE2b

Reset, Output 2A or 2B

Tune reset to eliminate the offset or droop between the set point and the actual process temperature for PID A output 2. When set to reset is disabled.

rE2A This prompt appears only if (Calibration Menu) is set to and **Pb2A** is set higher than .

If	Default	
	<input type="text" value="000.0"/>	... <input type="text" value="999.9"/> repeats/min.
	<input type="text" value="rE2A"/>	<input type="text" value="rE2A"/>
Pdr	<input type="text" value="400.0"/> %...	<input type="text" value="0.0"/> %... <input type="text" value="100.0"/> %
<input type="text" value="AL90"/> (Global Menu)	<input type="text" value="rE2A"/>	<input type="text" value="rE2A"/>

IE2A

IE2b

Integral, Output 2A or 2B

Tune integral to eliminate the offset or droop between the set point and the actual process temperature for PID output 2. When set to integral is disabled.

IE2A This prompt appears only if (Calibration Menu) is set to and **Pb2A** is set higher than .

NOTE:
The PID B Menu appears only on controllers with enhanced software (98_B-_____-_____).

Default	
<input type="text" value="0.00"/>	... <input type="text" value="999.9"/> repeats / min.
<input type="text" value="IE2A"/>	<input type="text" value="IE2A"/>

rA2A

rA2b

Rate, Output 2

Adjust the rate to eliminate overshoot on startup or after the set point changes. The rate setting will not influence the percent power if the process temperature is more than twice the proportional band from the set point. When set to rate is disabled.

This prompt appears only if (Calibration Menu) is set to and is set higher than .

Default
↓
 ... min.

dE2A

dE2b

Derivative, Output 2A or 2B

Adjust the derivative to eliminate overshoot on startup or after the set point changes. The derivative setting will not influence the percent power if the process temperature is more than twice the proportional band from the set point. When set to derivative is disabled.

This prompt appears only if (Calibration Menu) is set to and is set higher than .

Default
↓
 ... min.

NOTE:
The PID B Menu appears only on controllers with enhanced software (98_B-____-____).

Operation-PID A or B

CT2A

CT2B

Cycle Time, Output 2A or 2B

Select the time, in seconds, of a complete on/off cycle.

CT2A This prompt appears only if **CTL** (Global Menu) is not set to **SCd** and **Pb2A** is set higher than **0**.

If ↓		Default ↓
mechanical relay outputs	5.0 ... 10.0 ... 999.9 CT2A CT2A CT2A	
open collector or solid-state relay outputs	brSt 0.1 ... 1.0 ... 999.9 CT2A CT2A CT2A	

db A

db b

Dead Band A or B

Select the width of the zone between the action of the heating output and the cooling output. If you select a positive value the heat and cool outputs cannot be energized at the same time. If you select a negative value, both outputs can be energized at the same time.

- If a process input is selected the decimal precision will be determined by the **dEC1** setting (Input Menu).

db A This prompt appears only if **Pb2A** is set higher than **0** and one output performs heating action and the other performs cooling action.

NOTE:
The PID B Menu appears only on controllers with enhanced software (98_B- - - - -).

If ↓		Default ↓
oF CTF (Global Menu)	-999 ... 0 ... 999 db A db A db A	
oC CTF (Global Menu)	-555 ... 0 ... 555 db A db A db A	
a process input is selected	-999 ... 0 ... 999 units db A db A db A	







Chapter 6 The Factory Menu





Navigating the Factory Menu

NOTE:
The Factory Menu will not appear if the hardware lockout DIP is set to on. See Chapter 1 for more information.



NOTE:
The Factory Menus can only be entered when the setup prompt **SEE** is displayed.

NOTE:
Press the Display key **DISPLAY** to return to the Display Loop from any point in any menu.

To reach the Factory Menu, begin in the Display Loop and press the Up-arrow  and Down-arrow  keys together and hold for three seconds. The **SEE** prompt will appear in the lower display. Press and hold the Up-arrow  and Down-arrow  keys together again for three seconds until the **FctY** prompt appears in the lower display. The Factory Menu will not appear if the hardware lockout DIP is set to on. (See Chapter 1 for more information on DIP switch settings.) The three Factory Menus are: Panel Lockout **PLOC**; Diagnostics **d,AG**; and Calibration **CAL**. Upon reaching the Factory Menu prompt **FctY** use the Up-arrow  or Down-arrow  key to select a menu and the Mode key **MODE** to step through a menu.

You will not see every prompt in any of these menus. The unit's configuration and model number determine which prompts appear. After stepping through each menu, the Series 988 returns to the Factory Menu prompt **FctY**. Use the Up-arrow  and Down-arrow  keys to select the next menu, or use the Mode key **MODE** to advance through the same menu again. To move backwards through the menu hold down the Mode key **MODE** and press the Up-arrow key . Use the Up-arrow  or Down-arrow  key to change the prompt setting.



1 Press the Up-arrow  and Down-arrow  keys together and hold until the **SEE** prompt appears in the lower display. Press and hold again until the **FctY** prompt appears in the lower display.

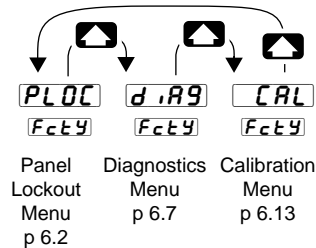

Figure 6.1 - Navigating the Factory Menu.



2 Use the Up-arrow key  to select one of the Factory Menus.

Factory-Panel Lockout

Reaching the Panel Lockout Menu



③ Select the Panel Lockout Menu, then press the Mode key **MODE** to step through the prompts.

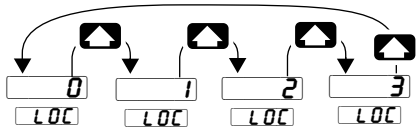
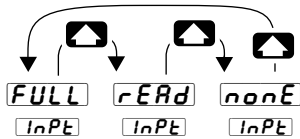

④ Press the Up-arrow key **▲** or the Down-arrow key **▼** to select one of the prompt values.

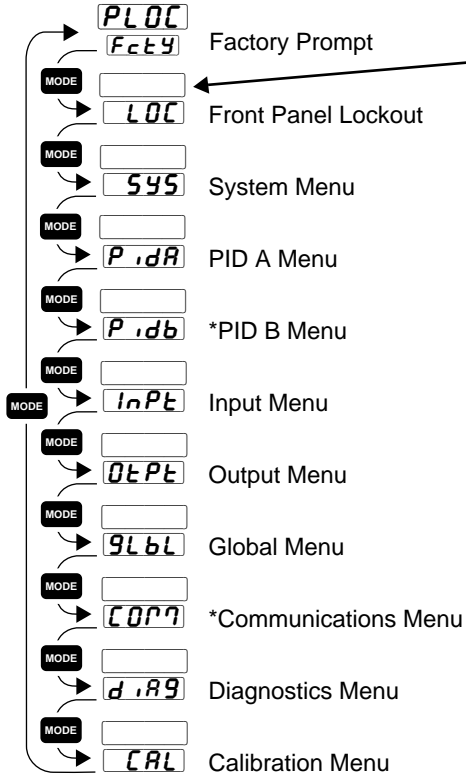





Enter your settings, from the controller's upper display.

*Prompts may not appear, depending on controller configuration.

Figure 6.2 - The Panel Lockout Menu.

Panel Lockout Prompts

When you are in the Factory menus, the Series 988 displays the menu selection (**PLOC**, **DRG** or **CAL**) in the upper display and **Fcty** in the lower display.

The Up-arrow  or Down-arrow key  selects another menu. Press the Mode key **MODE** to display the first prompt in the lower display and its value in the upper display. Use the Up-arrow  and Down-arrow  keys to change the value in the upper display. The new value will not take effect until after a five-second delay or until you press the Mode key **MODE**.

Front Panel Lockout



CAUTION:

Setting **LOC** to **2** or **3** disables the Auto/Man key **AUTO/MAN** and will force the controller into manual mode if an open sensor occurs. Verify that the controller is operating in the desired mode (auto or manual) before setting the lockout level. Failure to do so could result in damage to equipment and or property.

Sets the Lockout level for the Front Panel. This allows you to disable keys on the front of the controller.

- **0** enables all keys.
- **1** disables the Mode key **MODE**.
- **2** disables the Mode key **MODE** and the Auto/Man key **AUTO/MAN**.
- **3** disables the Mode key **MODE** and the Auto/Man key **AUTO/MAN** and locks the set point value.

LOC This prompt always appears.

Default



0	1	2	3
LOC	LOC	LOC	LOC

Factory-Panel Lockout

The prompts within the Panel Lockout Menu allow you to lockout an entire menu. You can set the level of lockout to none `nonE`, read only `rERd`, or lockout read and write `FULL`.

`545`

System Menu

Select the lockout level for the System Menu. Set the System Menu lockout to no lockout `nonE`, read only `rERd` or full lockout `FULL`.

`LDC` This prompt always appears.



`P,dR`

PID A Menu

Select the lockout level for the PID A Menu. Set the PID A Menu lockout to no lockout `nonE`, read only `rERd` or full lockout `FULL`.

`P,dR` This prompt always appears.

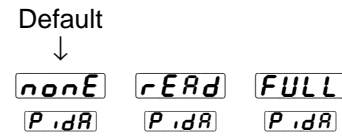

`P,db`

PID B Menu

Select the lockout level for the PID B Menu. Set the PID B Menu lockout to no lockout `nonE`, read only `rERd` or full lockout `FULL`.

`P,db` This prompt appears only on controllers with enhanced software (98_B-_-_-_-_) and with `AL90` (Global Menu) set to `P,d2` or `CntL` (Global Menu) set to `CSCd`.

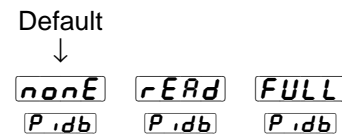

InPt

Input Menu

Select the lockout level for the Input Menu. Set the Input Menu lockout to no lockout **nonE**, read only **rERd** or full lockout **FULL**.

InPt This prompt always appears.

Default



nonE **rERd** **FULL**

InPt **InPt** **InPt**

OutPt

Output Menu

Select the lockout level for the Output Menu. Set the Output Menu lockout to no lockout **nonE**, read only **rERd** or full lockout **FULL**.

OutPt This prompt always appears.

Default



nonE **rERd** **FULL**

OutPt **OutPt** **OutPt**

GLbL

Global Menu

Select the lockout level for the Global Menu. Set the Global Menu lockout to no lockout **nonE**, read only **rERd** or full lockout **FULL**.

GLbL This prompt always appears.

Default



nonE **rERd** **FULL**

GLbL **GLbL** **GLbL**

Factory-Panel Lockout

COP7

Communications Menu

Select the lockout level for the Communications Menu. Set the Communications Menu lockout to no lockout **nonE**, read only **rERd** or full lockout **FULL**.

COP7 This prompt appears only on controllers equipped with Communications hardware (98__-____-R__ or 98__-____-S__).

Default



nonE **rERd** **FULL**
COP7 **COP7** **COP7**

d ,R9

Diagnostics Menu

Select the lockout level for the Diagnostics Menu. Set the Diagnostics Menu lockout to no lockout **nonE**, read only **rERd** or full lockout **FULL**.

d ,R9 This prompt always appears.

Default



nonE **rERd** **FULL**
d ,R9 **d ,R9** **d ,R9**

CAL

Calibration Menu

Select the lockout level for the Calibration Menu. Set the Calibration Menu lockout to no lockout **nonE**, read only **rERd** or full lockout **FULL**.

CAL This prompt always appears.

Default



nonE **rERd** **FULL**
CAL **CAL** **CAL**

Factory-Diagnostics

DATE

Factory Ship Date

Shows the date that the final factory control test was performed. The first two digits represent the week as numbered from **01--** to **52--**. The second two digits represent the year **--94**, **--95**, etc...

DATE This prompt always appears.

SOFT

Software Revision

Shows the controller's software revision code when set to **YES.** This letter should match the software revision code on the cover of the manual that came with your controller; **n** and W988-XUMN Rev **N00**.

SOFT This prompt always appears.

Sn--

Serial Number

Shows the controller's serial number. The first two letters in the upper display are to indicate that the controller is in serial number mode. The right half of the upper display shows the first two digits of the serial number. The lower display shows the last four digits of the serial number.

Sn34

5678

This is what the controller with the serial number 0988**345678** would display.

Sn-- This prompt always appears.

AP76

Ambient Temperature

Shows the ambient temperature at the Input 1 terminals. The temperature is shown in °F in the form **0000** regardless of the settings of **DEC1**, **DEC2**, **dFL** or **C_F**.

AP76 This prompt always appears.

`Rcnt`

`9nd`

`cnt1`

`cnt2`

Factory Use Only

These prompts are used only at the factory.

`Rcnt` `9nd` `cnt1` `cnt2` These prompts always appear.

`.tY1`

`.tY2`

Inputs 1 and 2 Module Types

Displays which input module is installed in the controller. Please document this value before contacting the factory for technical assistance.

Input Types

- `nonE` No input module
- `tc` Thermocouple only module
- `curr` Current detect
- `SLid` Slidewire module
- `UOFF` Universal off
- `Urtd` Universal rtd
- `Utech` Universal high-gain thermocouple
- `Utecl` Universal low-gain thermocouple
- `UP7u` Universal millivolts
- `UPrc` Universal process
- `E.2` Event input 2

`.tY1` `.tY2` These prompts always appear.

0EY1

0EY2

0EY3

0EY4

Outputs 1, 2, 3 and 4 Module Types

Display the controller's output module. Please document this value before contacting the factory for technical assistance.



Output Types

- **nonE** no output module (A)
- **55r1** 0.5A solid-state relay (K)
- **5515** 0.5A solid-state relay with suppression (B)
- **dc** switched dc open collector (C)
- **rLYc** form C relay (E)
- **rLc5** form C relay with suppression (D)
- **rLRb** relay A/B (J)
- **Proc** process output (F)
- **UrEt** voltage/retransmit (N)
- **IrEt** current/retransmit (M)
- **SPLY** power supply (T)
- **232** EIA/TIA-232 communications (R)
- **485** EIA/TIA-485 or EIA/TIA-422 communications (S)
- **232** EIA/TIA-232 or EIA/TIA-485 communications (U)

0EY1 0EY2 0EY3 0EY4 These prompts always appear.

d,SP

Test Displays

Runs a brief test of the controller's displays and LEDs. To run the test, scroll through the Diagnostics Menu until **d,SP** is shown in the lower display. Use the Up-arrow key  or Down-arrow key  to select **YES** from the upper display and press the mode key **MODE**.

The controller will run pattern tests, blink all the LEDs on and off, and end with the model number in both displays.



d,SP This prompt always appears.

Default
↓

no	YES
d,SP	d,SP

tout

Test Outputs

This prompt tests each output. To run the test, scroll through the Diagnostics Menu until **tout** is shown in the lower display. Use the Up-arrow key  or Down-arrow key  to select an output **out 1**, **out 2**, **out 3**, or **out 4**. The LED for that output should light after a second or two indicating that the output has been successfully energized. Do not press the mode key **MODE** to activate the test; it starts automatically when anything other than **OFF** is selected.

If any of the LEDs fail to light contact the factory.

tout This prompt always appears.

Default
↓

OFF	out 1	out 2	out 3	out 4
tout	tout	tout	tout	tout

OPLP

Open Loop

Checks the control loop, consisting of the controller output, power control, heater and sensor. With open loop enabled, the controller monitors the output power level and checks for a change in the process input value. If the output power is at maximum for a period of time equal to the reset time and the process input has not changed by at least $\pm 5^{\circ}\text{F}$, the controller will switch to manual mode at 0% output power and **OPLP** will be displayed in the lower display.

To clear this error, enter the Setup Menu and press the display key **DISPLAY**. To get back into auto mode, press the Auto/Man key **AUTO MAN**.

OPLP This prompt always appears.

Default



OFF	on
OPLP	OPLP

Reaching the Calibration Menu

1 Begin in the Display Loop, and press the Up-arrow and Down-arrow key simultaneously for six seconds until the Setup Menu **SEt**, then the Factory Menu **FcTY** appear.

2 Use the Up-arrow key or Down-arrow key to step through the Factory Menu to the Calibration Menu **CAL**.

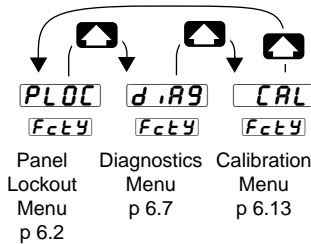

3 Press the Mode key **MODE** to step through the prompts.

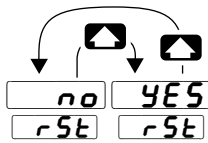

4 Press the Up-arrow key or the Down-arrow key to select one of the prompt values.

Refer to *Calibrating Watlow Process Controls* for information about the Calibration Menu.



CAUTION:
Before attempting to calibrate, make sure you have the proper equipment called for in each procedure. The Series 988 is calibrated and tested before it leaves the factory. Attempting to calibrate the controller without the proper equipment could result in damage to property and/or equipment.

Figure 6.13 - The Calibration Menu.

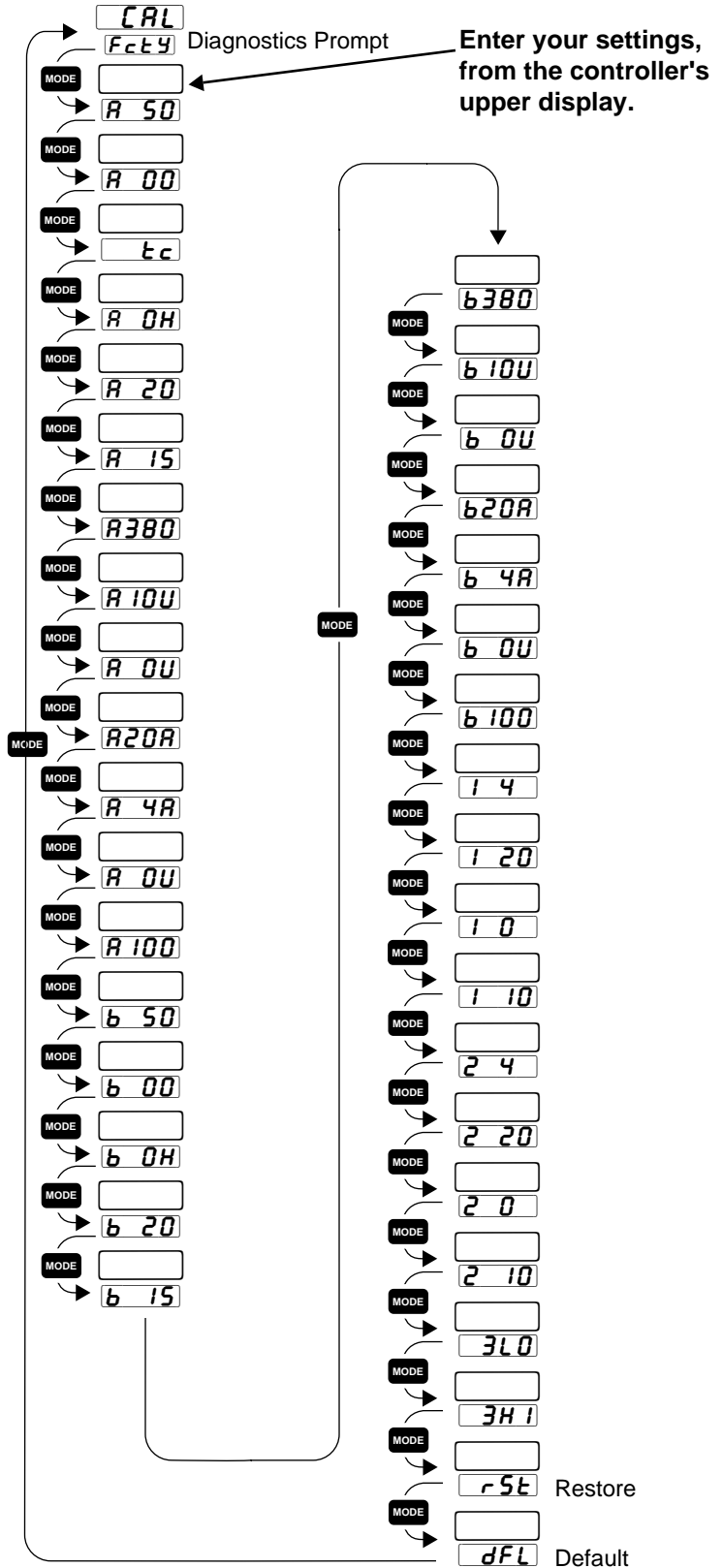

Factory-Calibration

rSt

Restore

Restores the original factory calibration values when set to **YES.**
This is a simple way to recover from a mistake made while calibrating the controller.

rSt This prompt always appears.

Default



no	YES
rSt	rSt

dFl

Default

Set the operating parameter defaults to domestic or international measures.

- **US** (domestic) sets the controller to °F; rate in minutes; proportional band in degrees or units; and reset in repeats per minute.
- **SI** (international) sets the controller to °C; derivative in minutes; proportional band in percent of span; and integral in minutes per repeat.

dFl This prompt always appears.

Default



US	SI
dFl	dFl

Chapter 7 Tuning, Manual Operation, Alarms and Error Codes

Auto-tuning (Heat and/or Cool)

The Series 988 can automatically tune the PID parameters to fit the characteristics of your particular thermal system.

Standard software units (98_ **A** - _ _ _ _ - _ _ _ _) have 1 set of PID parameters. Units with enhanced software (98_ **B** - _ _ _ _ - _ _ _ _) and **AL90** set to **PID2** (Global Menu) have two sets of PID parameters, PID A and PID B. Only one PID set can be auto-tuned at a time. For information on tuning a cascade system, see Chapter 8.

NOTE:
A useful reference on tuning is *Tuning of Industrial Control Systems* by Arman-do B. Corripio, published by the Instrument Society of America.

Before beginning the auto-tune sequence, make sure the **ALSP** parameter located in the Global Menu is at the proper setting. This allows the user to select the tuning set point as a percentage of the current control set point. See Chapter 4 for more information on this parameter. The figure below uses the default setting, 90%, to define the auto-tuning process.

NOTE:
Auto-tune can be initiated if **ALSP** is set to **on**.

Once the auto-tune sequence has begun, the output 1 and output 2 proportional band is set to 0 and the control goes into an on/off mode of control at the set point percentage determined by the **ALSP** parameter. The displayed set point remains unchanged.

Figure 7.1 - Auto-tuning example.

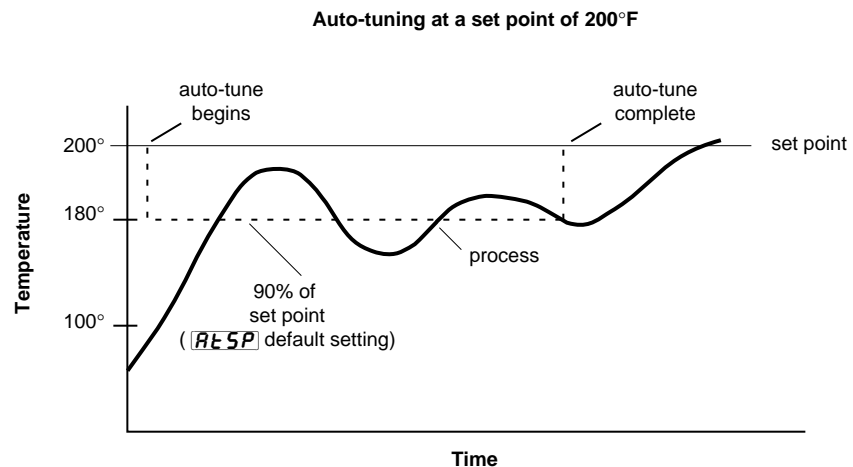

Tuning

When the control finishes “learning” the system, it resumes standard PID control using the PID values established by the auto-tuning process. Changing the set point during an auto-tune restarts the auto-tune procedure.

















CAUTION:

If a mechanical relay or contactor is switching power to the load, a longer cycle time may be desirable to minimize wear on the mechanical components. The typical life of a mechanical relay is 100,000 cycles. Verify that the cycle time selected is appropriate for the output device type. Failure to do so could result in damage to equipment and/or property.

During auto-tuning the process must cross the set point four times within an 80-minute time span for the Series 988 to successfully complete the auto-tune. If this does not happen within the 80-minute time limit, the Series 988 chooses PID values based on the 80-minute tuning cycle performed.

To start auto-tuning:

1. **Press the Mode key**  to advance to the System Menu . Press the Mode key  to advance through the menu until the  prompt appears in the lower display.
2. **Use the Up-arrow**  **or Down-arrow**  **key** to select  or , if your controller is equipped with enhanced software (98_B_ _ _ _ _). Only one PID set can be auto-tuned at a time.
3. **Press the Display key** . While the control is in the tuning mode the lower display alternates every second between the normal information and the  prompt.
4. **When tuning is complete**, the displays return to their previous state and  reverts to . The Series 988 installs the PID tuning parameters it has calculated and saves them in non-volatile memory.

To abort auto-tuning either reset the  prompt to off, press the Auto/Man key  twice, or cycle power off and on. In all cases, aborting auto-tune restores all values to their state before auto-tuning began.

Manual Tuning

For optimum control performance, tune the Series 988 to your thermal system. The tuning settings here are for a broad spectrum of applications; your system may have somewhat different requirements. NOTE: This is a slow procedure that may take hours to obtain optimum values.

Tune heating outputs at a set point above the ambient process value.
Tune cooling outputs at a set point below the ambient process value.

If your controller is equipped with enhanced software (98_B_ _ _ _ _ _ _ _), the  parameters may need to be tuned also. Perform this procedure on both PID sets, they are functionally identical. The parameters within the procedure apply to both output 1 and 2, and PID A and B.

1. **Apply power to the Series 988** and enter a set point. Begin with set to ; or set to ; or set to ; set to ; set to ; and set to .
2. **Proportional Band Adjustment:** Gradually increase until the upper display process value stabilizes at a constant value. The process value will not be right on set point because the initial reset value is 0.00 repeats per minute. (If is set to then , , and are inoperative, and the Series 988 functions as a simple on/off control.) The prompt determines the switching differential value.
3. **Reset/Integral Adjustment:** Gradually increase or until the upper display process value begins to oscillate or “hunt.” Then slowly decrease or until the upper display stabilizes again near set point.
4. **Cycle Time Adjustment:** Set as required. Faster cycle times sometimes achieve the best system control. See Chapter 8 for more information on the burst fire feature. However, if a mechanical contactor or solenoid is switching power to the load, a longer cycle time may be desirable to minimize wear on the mechanical components. Experiment until the cycle time is consistent with the quality of control you want. will not appear on units with a process output (98_ _ _ _ F _ _ _ _ or 98_ _ _ _ F _ _ _ _).
5. **Rate/Derivative Adjustment:** Increase or to 0.10 minute. Then raise set point by 20° to 30°F, or 11° to 17°C. Observe the system’s approach to the set point. If the load process value overshoots the set point, increase or to 0.50 minutes.

Raise the set point by 20° to 30°F, or 11° to 17°C and watch the approach to the new set point. If you increase or too much, the approach to set point will be very sluggish. Repeat as necessary until the system rises to the new set point without overshooting or approaching the set point too slowly.
6. **Calibration Offset Adjustment:** You may want your system to control to a process value other than the value coming from the input sensor. If so, measure the difference between that process value (perhaps at another point in the system) and the process value showing in the upper display. Then enter the offset value you want. Calibration offset adds or subtracts degrees from the value of the input signal.

Manual and Automatic Operation

To change from auto to manual operation, press the Auto/Man key  twice.

Manual operation provides open-loop control of the outputs from a range of -100% to 100% output. The Series 988 allows a negative output value only when or (Output Menu) is set to (cool).

NOTE:
When a sensor opens, the controller switches from automatic to manual operation.

Automatic operation provides closed-loop on/off or PID control. When the operator transfers from a closed loop to an open loop, the Series 988 sets the power level to the setting of the parameter. If is set to the controller retains the power level from the closed-loop control. When the Series 988 returns to closed-loop control, it restores the previous set-point process value.

The Auto/Man LED (located on the Auto/Man key ) indicates whether the controller is in automatic or manual operation. When the LED is lit, the control is in manual operation. When the LED is off, it is in automatic operation. When the LED flashes, press the key again within five seconds to complete the change in operation.

- If is set to and the process has stabilized at a power level less than 75% ($\pm 5\%$) for a two-minute period prior to the sensor break, then the Series 988 switches to manual operation at the last automatic power level. If these conditions are not met, the output goes to 0% power (output disabled).

When transferring from automatic to manual operation, the control output, or outputs, remain stable — a bumpless, or smooth, transition. The lower display changes from the set point to the % output value.

- If is set from to , the Series 988 switches to manual operation at that percent power.

Changing the Output 3 Alarm Jumper

If you have model number **98** _ _ - _ _ _ _ - **J** _ _ _ , output 3 can be configured as a Form A (NO and common contact) or Form B (NC and common contact) alarm. To change the alarm jumper:

1. Remove the control from the case. Release the two tabs on one side of the control, then release the two tabs on the opposite side. You may need to rock the bezel back and forth several times to release the chassis.
2. Set the jumper to the position you want. See below for jumper location.

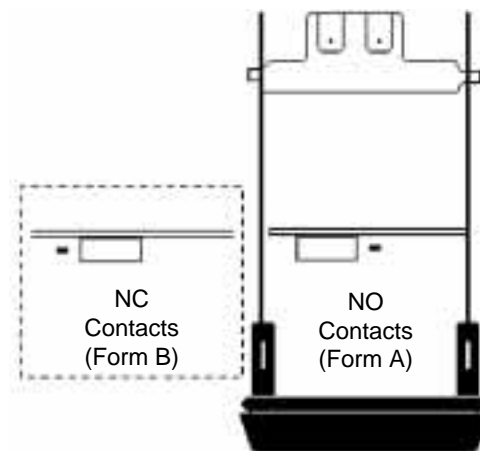

Figure 7.5 - Alarm jumper location.

Controller Chassis - Top View

3. Return the controller chassis to the case. Be sure you have it oriented correctly. Press firmly, but gently, to seat the chassis.

If you select Form A, the contact is open when power is removed from the control. If you select Form B, the contact closes when power is removed.

Using Alarms

Output 2, 3, and 4 of the Series 988 can function as alarms. This is accomplished with the **OE2**, **OE3** or **OE4** prompt (Output Menu). If **AL2**, **AL3** or **AL4** is selected, the output is energized in the non-alarm condition and de-energizes the output in the alarm condition. Selecting **AL2n**, **AL3n** or **AL4n** reverses this action: de-energizing the output in a non-alarm condition and energizing it in an alarm condition.

If the L2, L3 or L4 LED on the front panel is lit, this indicates an alarm condition for output 2, 3 or 4 respectively.

Once you've configured the outputs as alarms, enter the Output Menu again and select the **AL2**, **AL3** or **AL4** prompt. At these prompts you can select the type of alarm: process; deviation; or rate. Each may be independently set low and high. Choose between **Pr1** (process alarm input 1), **Pr2** (process alarm input 2), **dE1** (deviation alarm input 1), **dE2** (deviation alarm input 2) or **rAEE** (rate alarm referenced to input 1).

Example: **Pr1** can reference the input 1 process value against the **R2L0** and **R2H1** settings, or **Pr2** can reference the input 2 process value against the **R2L0** and **R2H1** settings.

NOTE:

An alarm display will be masked by an error condition or when the control is in the Calibration or Setup menus.

A **process alarm** sets an absolute temperature range or process value range. When the temperature or process leaves the range an alarm occurs. A process alarm is not tied to the set point.

Example: If your set point is 100°F and a process alarm high limit is set to 150°F and the low limit is set to 50°F, the high limit trips at 150°F, and the low alarm at 50°F. If you change the set point, the process alarm limits remain the same.

A **deviation alarm** alerts the operator when the process strays too far from the set point. The operator can enter independent high and low alarm settings. The reference for the deviation alarm is the set point. Any change in set point causes a corresponding shift in the deviation alarm. Low alarms are usually set at a negative deviation while high alarms are a positive deviation.

Example: If your set point is 100°F, a deviation alarm high limit is set to +7°F and the low limit is set to -5°F, then the high alarm trips at 107°F, and the low alarm at 95°F. If you change the set point to 130°F, the alarms follow the set point and trip at 137°F and 125°F.

A **rate alarm** alerts the operator when the process monitored by input 1 is increasing at a rate higher than the alarm high setting (**R2H1**, **R3H1** or **R4H1**) or decreasing at a rate lower than the alarm low setting (**R2L0**, **R3L0** or **R4L0**). The rate is sampled once a second.

Alarms can be latching or non-latching. When the alarm condition is removed, a non-latching alarm automatically clears the alarm output and alarm message, if one is present. You must manually clear a latching alarm before it will disappear.

The alarm output is indicated by the corresponding LED on the front panel: L2; L3; or L4. There may be an alarm message flashing in the lower display, but if the **Alarm** prompt is set to **OFF** (Global Menu), no alarm message is displayed. When an alarm message is displayed, it alternately flashes with the current prompt at a one-second interval in the lower display.

To clear a latching alarm, first correct the condition then press the Auto/Man key **AUTO MAN** once.

Alarm silencing is available with all alarms. This function overrides the alarm on initial power up. On power up, the alarm message will not appear and the appropriate L2, L3 or L4 LED and output will reflect a non-alarm condition. Silencing is active until the process has entered the safe region located between the low- and high-alarm settings. Then deviation outside this safe zone triggers an alarm. If an alarm occurs at this point, the output can be silenced by pressing the Auto/Man key **AUTO MAN** once, but the controller still displays the alarm message.

Error Codes

Error Code E1 and E2 Messages

Four dashes, `----`, in the upper display indicate a Series 988 error. The control goes into the manual mode and maintains the percent output selected at the `FRIL` prompt (Global Menu). That value (percent of output) is shown in the lower display.

NOTE:

To view the error code press the Auto/Man key `AUTO/MAN` once. The upper display shows the error code for five seconds before returning to the `----` display.

E1 1 E2 1: A/D underflow error

The analog-to-digital (A/D) converter of the input indicated by the first number is under range. An open or reversed polarity sensor is the most likely cause. Check the sensor. Make sure the input prompt is set to the correct sensor.

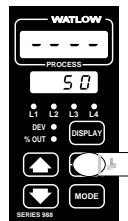

Figure 7.8 - Error code display.

E1 2 E2 2: Sensor under-range error

The sensor at the input indicated by the first number generated a value lower than that allowed for the range of the sensor, or the analog-to-digital (A/D) converter malfunctioned. Make sure the setting for the input (Input Menu) matches the sensor type and that the sensor range falls within the range of the process being controlled.

E1 3 E2 3: Sensor over-range error

The sensor at the input indicated by the first number generated a value higher than that allowed for the range of the sensor, or the analog-to-digital (A/D) converter malfunctioned. Make sure the setting for the input (Input Menu) matches the sensor type and that the sensor range falls within the range of the process being controlled.

E1 4 E2 4: A/D overflow error

The analog-to-digital (A/D) converter at the input indicated by the first number is over range. An open or reversed polarity sensor is the most likely cause. Check the sensor. Make sure the input (Input Menu) is set to the correct sensor type.

The analog-to-digital (A/D) converter input voltage may be too high to convert an A/D signal.

NOTE:

An alarm display will be masked by an error condition or when the control is in the Calibration or Setup menus.

Er3: Ambient temperature error

The ambient temperature of the Series 988 has dropped below 32°F/0°C or risen above 149°F/65°C. Calibration errors can also cause this error code. Try setting **Er5t** (Calibration Menu) to **YES**. (Read about Factory Calibration in Chapter 6.)

Er4: RAM verification error

An internal RAM failure has occurred. Contact the factory.

Er5: Non-volatile checksum error

An EEPROM checksum error was detected. Turn the power off then back on again. If this does not clear the error, contact the factory.

QPLP: Open-loop detect

This error is not available while in the on/off mode. It is only active when **QPLP** is set to **on** (Diagnostics Menu).

Er9: Configuration error

An incorrect module has been installed in the control. Contact the factory.



Error Code Actions

All of the above error codes except **Er4**, **Er5** and **Er9** will result in these conditions:

- If **FRIL** is set to **bPL5** (Global Menu)...
 - ...and the control was in automatic operation when the error occurred, it goes into manual (% power) operation. If the output power is less than 75% ($\pm 5\%$) power and there was a change in power ($< 5\%$) within the last two minutes, the Series 988 switches to manual operation at the last automatic power level (bumpless transfer). If the control was in manual operation, it remains there. (Press the Auto/Man key  once to see the error code.) The error code is shown in the upper display for five seconds and the lower display shows the % power. After five seconds the upper display reverts to the **----** display.
- If the control was operating with stable output values when the error occurred, it continues to operate at those levels on a percent-power basis.
- If output values were not stable, or the percent output was greater than 75%, the control outputs drop to 0% power (off).
- If **FRIL** is not set to **bPL5**...
 - ... and the control was in automatic operation when the error occurred, it goes into manual (% power) operation. The power level is determined by the **FRIL** prompt value (**-100** to **100** percent).

Error Codes

To clear an error code...

- If **Err** is set to **nLA**, the error code should clear once the problem is corrected.
- If **Err** is set to **LAE**, correct the problem and cycle power. You can also clear the error by pressing both the Up-arrow  and Down-arrow  keys to enter the Setup Menu, then press the Display key .

Error codes **Er4**, **Er5** and **Er9** will result in these conditions:

- The control is in automatic operation with both control outputs off.
- The alarm outputs are in their alarm state (de-energized with the LED lit).
- The lower display is blank.
- The upper display indicates the error code.
- All keys are inactive.
- With **Er5**, all Setup Menu prompts return to default values.
- The above conditions occur regardless of the **FRIL** value, or the settings in the Setup and Factory menus.

NOTE:

An alarm display will be masked by an error condition or when the control is in the Calibration or Setup menus.

Cycle power to the control. If the error is still present contact the factory.

Chapter 8 General Software

Burst Fire	8.2
Communications	8.4
Dead Band	8.6
Digital Events	8.8
Heater Current	8.10
Input Filter	8.12
Input Linearization	8.14
Ramp to Set Point	8.16
Remote Set Point	8.18
Retransmit	8.20
Slidewire Feedback	8.22

Burst Fire

Requirements

- This feature only works with zero-cross, solid-state devices. It will not function correctly with random-fire devices.
- To enable burst fire the Series 988 must have an open collector or solid-state relay output: controllers with option “B,” “C” or “K” selected for output 1 (98_ _ _ _ * _ _ _ _ _), output 2 (98_ _ _ _ * _ _ _ _ _), output 3 (98_ _ _ _ _ * _ _ _ _) or output 4 (98_ _ _ _ _ * _ _ _ _).
- The time burst is appropriate for fast loads or very tight control. It provides advantages only for PID control, not for on/off control.
- The short time bases used by burst fire makes it incompatible with the heater current feature (98_ _ _ 4 _ _ _ _ _). The heater current option requires a minimum of 300 milliseconds on time to get a reading.
- The Series 988 has built in zero-cross detection circuitry, eliminating the need for external firing circuitry to trigger SCR's. The controller will not allow burst fire to be selected if its zero-cross detection circuitry is not functioning.
- The feature is enabled by selecting burst fire `br5t` at the cycle time prompt for the appropriate output in the PID Menu — `CE1A`, `CE1b`, `CE2A` or `CE2b`.
- Only the 988 and 989 can use the burst fire feature. The low-voltage units (986 and 987) cannot use burst firing.

Overview

Variable, time-base burst firing from the Series 988 provides the most even distribution of power with the lowest level of noise generation (RFI). An SSR or SCR firing card translates a command signal into a burst of ac cycles. The output is zero-cross fired, which always allows at least one full ac cycle to pass within the variable time base. Burst firing is the preferred mode to control resistive loads.

The Series 988 detects when the ac sine wave of the load will cross the 0-volt point. It uses this information to switch the load on or off only at a 0-volt point, minimizing RFI.

The burst fire time base in the Series 988 varies from a maximum 1.66-second time base (1-percent output; 1 cycle on, 99 off) down to a 33.3-millisecond time base (50-percent output; 1 cycle on, 1 off). The graphs on the next page show how the time base varies with the percent output.



CAUTION:

The burst fire feature only functions with zero-cross, solid-state devices. It will not function correctly with random-fire devices. Verify that the output switching device is compatible before selecting burst fire. Failure to follow this guideline could result in damage to equipment.

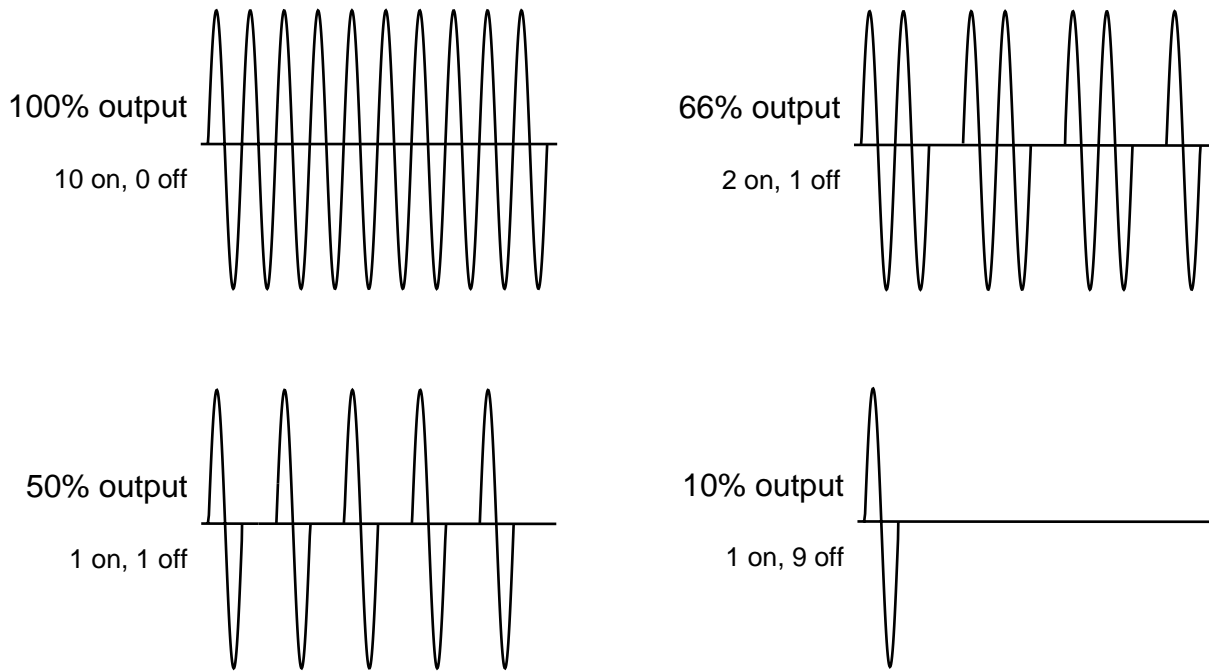

Figure 8.3a - Sine waves of burst fire settings.

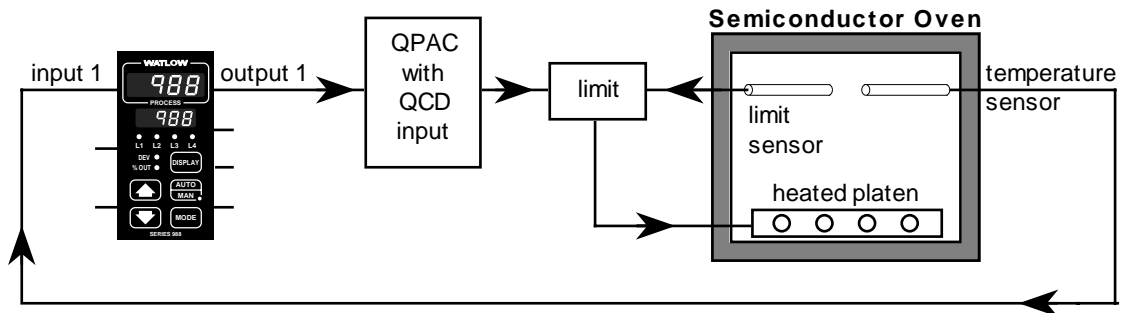

Figure 8.3b - Semiconductor oven with burst fire.

Sample Application

A Series 988 controls a heated platen in a semiconductor oven. Previously it used a power control requiring a 4-20mA signal to implement burst-fire control. We have replaced the power control with a Watlow Loyola QPAC with a QCD card that accepts a signal directly from an open-collector output of the Series 988. This gives smooth control at a lower overall system cost.

Communications

Requirements



Choose which interface your application will use: EIA/TIA-232 serial communications (98_ _ _ _ _ _ _ R_ _), EIA/TIA-485 or EIA/TIA 232 serial communications (98_ _ _ _ _ _ _ U_ _), or EIA/TIA-485 or EIA/TIA-422 serial communications (98_ _ _ _ _ _ _ S_ _). The computer must have a compatible serial port or an appropriate converter must be used.

Overview

The serial communications feature allows the Series 988 family to receive commands from and transmit data to a master device, usually a computer. Any function that can be performed via the front panel, can also be accomplished using a serial communications port, allowing you to operate the controller from a computer and to store process data on a computer. L4 acts as the RX/TX indicator on the front display panel of the 988.

The Series 988 is available with a choice of serial hardware interfaces. An EIA/TIA-232 interface allows for one master (computer) and one controller, with a maximum network length of 50 feet (15 meters).

The EIA/TIA-485 or EIA/TIA-422 option equips the controller for a multi-drop interface: up to 32 total network devices with EIA/TIA-485 and up to 10 total network devices with EIA/TIA-422. Each controller will have its own unique address. The total maximum network length is 4,000 feet (1,219 meters). All interfaces are isolated.

To select between EIA/TIA-485 or EIA/TIA-422, enter the Setup Menus by holding the up-arrow  and down-arrow  keys simultaneously until setup `SEE` appears in the bottom display. Use the up-arrow key to select the Communications Menu `CONF`. At the interface prompt `INTF` select between `422` or `485`.

Other parameters that must be configured in the Communications Menu `CONF` are the baud rate `BAUD`, data bits and parity `DATA`, protocol `Prot`, and device address `Addr`. The protocol prompt must be set to full (ANSI X3.28 2.2-A3) or RTU Modbus if multiple devices are used with the EIA/TIA-485 or EIA/TIA-422 interface. If the full protocol or RTU Modbus is selected, a device address must be selected at the address prompt. For EIA/TIA-232, full `FULL` or on `on` (XON/XOFF) protocol may be selected.

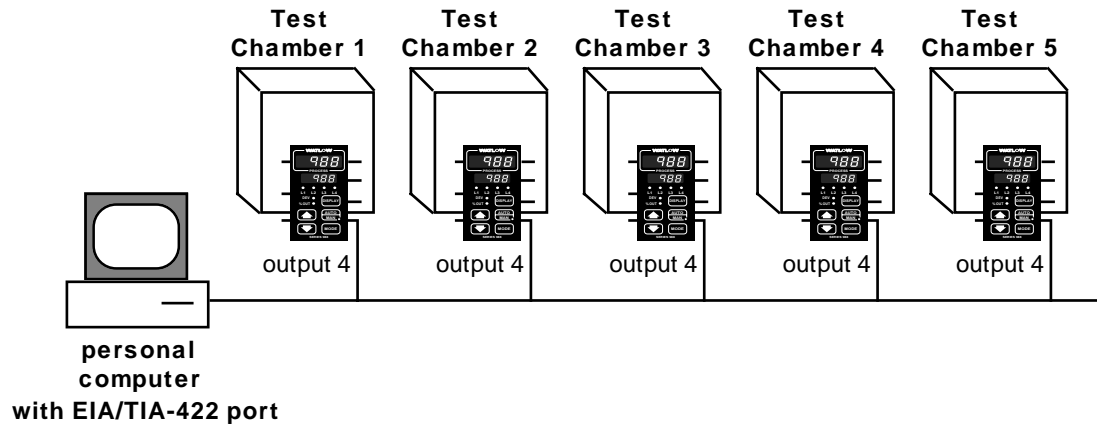

Figure 8.5 - Test chambers with communications.

Sample Application

A test engineer uses Series 988s to control the temperatures of several automated test chambers. His computer is linked to the controllers through its EIA/TIA-422 serial communications port. His computer program monitors the temperatures of the chambers and initiates automatic test sequences when certain program parameters are met. After completing a sequence, the computer loads the next temperature to the controller. The computer periodically interrogates each controller for its process temperature, set point and alarm status. This information is stored on a disk to provide test verification data for the completed products.

Dead Band



WARNING:
If the dead band is set to a negative value, the heat and cool outputs can both be ON at the same time.

Requirements

The dead band feature is standard on any Series 988 controller with two control outputs. The dead band prompts will appear if the control outputs are configured for heat/cool or cool/heat.

Overview

The dead band prompts, `db H` and `db C`, located in the PID menus, determine the amount of interaction between heat (reverse acting) and cool (direct acting) control outputs. The dead band directly offsets the target set point of the cool control output.

With a positive dead band, both control outputs will never be ON at the same time. With the process in a positive dead band, the output value is determined by adding the percent heat output to the percent cool output and only applying the result to the correct output — cooling action if the sum is negative and heating action if it is positive.

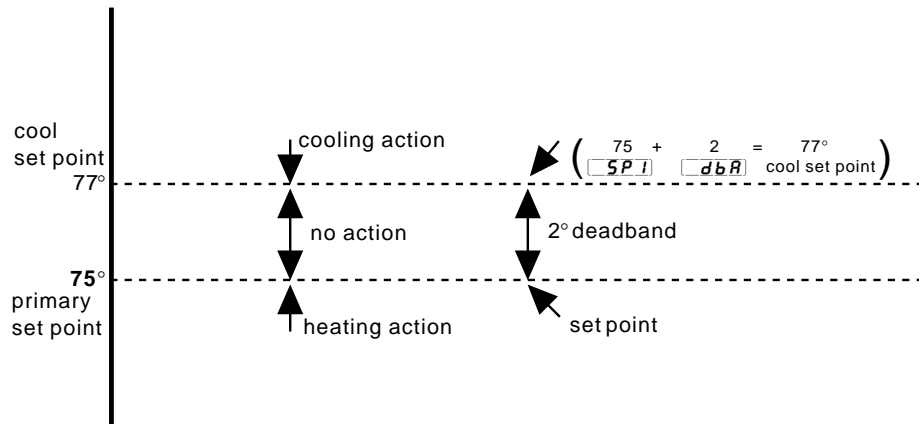

Figure 8.7a - Dead band graph.

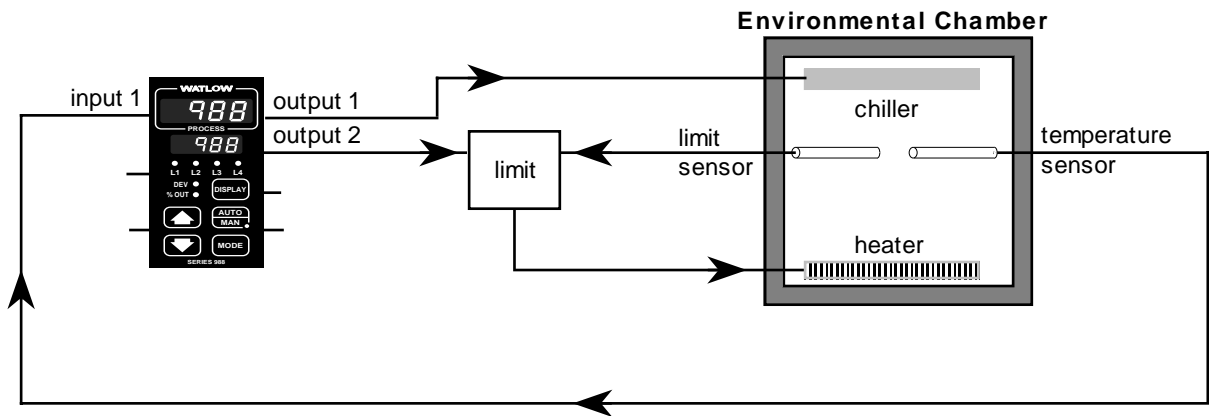

Figure 8.7b - Environmental chamber with dead band.

Sample Application

An engineer for an environmental chamber manufacturer, who is designing the heating and cooling system for a new chamber, wants to minimize the energy costs of operating the chamber. She has chosen the Series 988 and will configure the heat and cool outputs with a positive dead band.

When the chamber temperature is near ambient the cooling and heating systems had a tendency to buck one another, resulting in inefficient use of energy. The engineer started with a dead band of five degrees, but in the process of tuning the system for optimal control, the setting was reduced to two degrees. This made the chamber more energy efficient and reduced wear on the refrigeration system.

Digital Events

Requirements

A single digital event input is standard on all controls. A second digital input is available as an option for input 2 (98_ _-_5_ _- _ _ _).

Overview

The digital event input options on the Series 988 controller allow the operator to select one of several software functions with the close of a customer-supplied switch or by a change in dc voltage (See Chapter 2 for voltage and wiring information.).

The list below outlines the functions that can be controlled with a digital event input:

- **Idle set point** `IdSP` lets the operator select a second (idle) set point.
- **Turn control outputs off** `OFF` inhibits the control outputs.
- **Alarm reset** `ALr` resets alarms from a remote location.
- **Switch PID sets** `Pid` selects between PID set A or B (requires enhanced software, 98_B- _ _ _ _ - _ _ _ _).
- **Remote set point** `rSP` switches to remote set points.
- **Front panel lockout** `LDC` locks out the front panel keys to prevent tampering.
- **Control output action** `Actn` switches the control action of outputs 1 and 2 from heating to cooling, or vice versa.
- **Auto/Manual operation** `A-M` switches to the manual mode of operation at the percent power selected with `FAIL` (Global Menu) and disables the Auto/Man key.

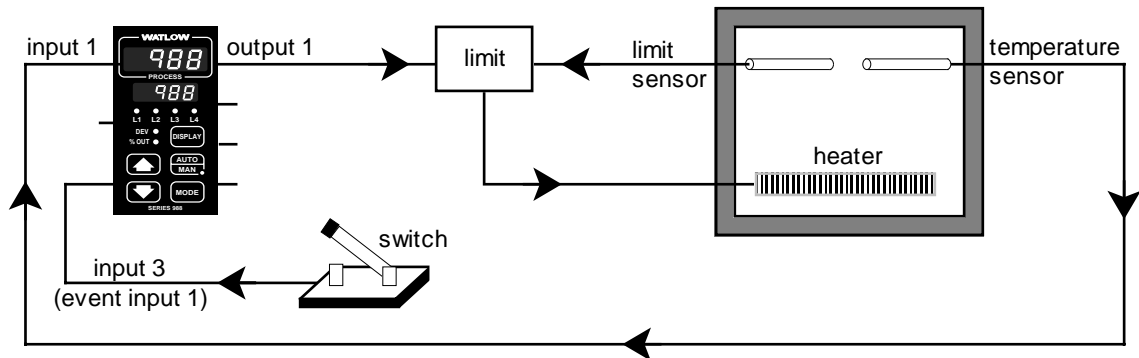

Figure 8.9 - Heater with digital event.

Sample Application

A manufacturing engineer is building an application that needs to switch to an idle temperature at the end of a batch and maintain that temperature until the next batch is loaded, with minimum operator interaction.

By connecting an external switch to the digital event input, he can select either the operating temperature or the idle temperature with the flip of a switch. The idle set point prompt is enabled by setting the Event Input 1 prompt **E, I**, in the Global Menu, to idle set point **IdSP**. The idle set point value is accessed by pressing the MODE key **MODE** from anywhere in the display loop. When the switch closes, the lower display will indicate the idle set point, and the controller will maintain this new set point.

Heater Current

Requirements

Choose the heater current option (98_ _-4_ _- _ _ _) for input 2 and an appropriate current transformer. A current transformer must be ordered separately.

NOTE:
To obtain a reading, the output ON-time must be a minimum of 0.3 seconds.

Output 1 cannot be used as a process output. The heater current feature monitors only output 1.

Overview

The heater current feature measures and responds to heater current in a system. This is an ideal method for detecting heater loss in applications with multiple heaters. The current is measured when output 1 is on. For instance, if a system has five, 10-amp heaters, the heater current input measures 50 amps regardless of the percent output.

NOTE:
The heater current feature will not function with burst-fire outputs.

To view the heater current press the DISPLAY key and advance to the Process 2 prompt (**Pr 2**). The upper display indicates the last valid current reading.

The Input 2 prompt (**In 2**) under the Input Menu (**InPt**) can be set to current (**Cur**) or loop error detect (**Loop**). Current (**Cur**) allows you to monitor heater current and set alarm set points based on high and low heater current values. Alarms can only be configured as process alarms (see Alarms, in Chapter 7). Setting to loop error detect (**Loop**) enables monitoring and alarm functions, and also triggers an error and shuts off all outputs if current is present with output 1 off or when no current is present and output 1 power is more than zero.

NOTE:
The heater current feature will not function when the Series 988 has a process output for output 1.

There are limits associated with this feature:

- To obtain a reading, the output on-time must be a minimum of 0.3 seconds. To calculate this, multiply the percent output by the cycle time setting. Example: With 30-percent output and a 2.0 second cycle time, the on-time would be: $0.30 \times 2.0 = 0.6$ seconds. This would yield a valid reading. If a valid reading is not possible, the 988 will display the last valid reading.
- The heater current feature will not function with the cycle time on output 1 set to **brSt**. (This does not apply to output 2, output 3, or output 4). This does not necessarily apply to the loop error detect feature. If enabled, any current detected with no output triggers an error.
- This feature will not function when the Series 988 has a process output for output 1 (98_ _-F_ _- _ _ _). A known cycle time is required to detect the current. There is no cycle time associated with process outputs.

The maximum signal the input can accept from the current transformer secondary is 50mA. So, you must calculate the output range of the current transformer before wiring the system.

NOTE:
Current transformer (up to 50A), Part #16-0246)

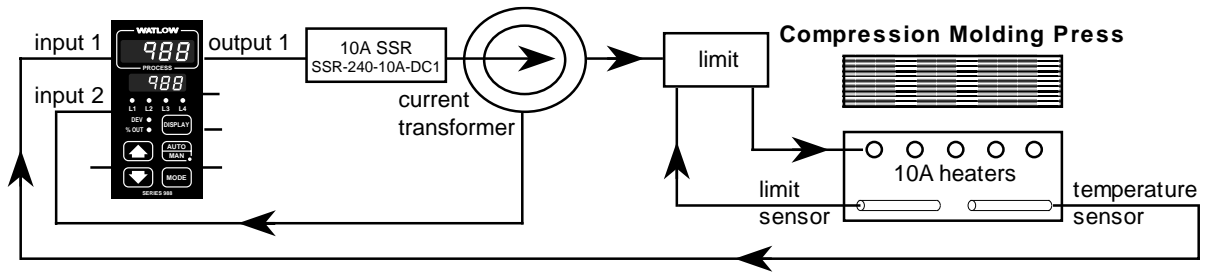

Figure 8.11 -
Compression mold-
ing press using the
heater current fea-
ture.

Sample Application

The Series 988 controls the lower platen of a compression molding press that contains five, 10-ampere heaters. A 50A:50mA current transformer is used to monitor heater current.

Set the Input 2 prompt `in2` to current `[curr]`, the Range Low 2 prompt `rL2` to 0 and the Range High 2 prompt `rH2` to 50. Find the range high 2 value with the following equation:

$$\text{range high 2} = \frac{(\text{maximum CT primary current (load current)})}{(\text{maximum output from CT secondary (input)})} \times 50\text{mA}$$

The application uses a Watlow current transformer (CT) part# 16-0233, which has a maximum input of 50 amperes, which corresponds to a maximum output of 50mA.

$$\text{range high 2} = \frac{(50\text{Amps})}{50\text{mA}} \times 50\text{mA}$$

Solving for rH2 gives you 50. This is the range high 2 setting.

Input Filter

Requirements

This feature is standard on all Series 988 controllers.

Overview

In certain applications the process being measured can be unstable, which makes it difficult to control and also makes the constantly changing display difficult to read. The Series 988 input filter can solve these problems by smoothing out just the display or the display and the input signal.

You can set a time constant in seconds for a low-pass filter that will, if you select a positive value, affect the display only. Select a negative value to filter the input signal itself.

NOTE:
Use this feature with caution, because a large time constant could hide system upsets.

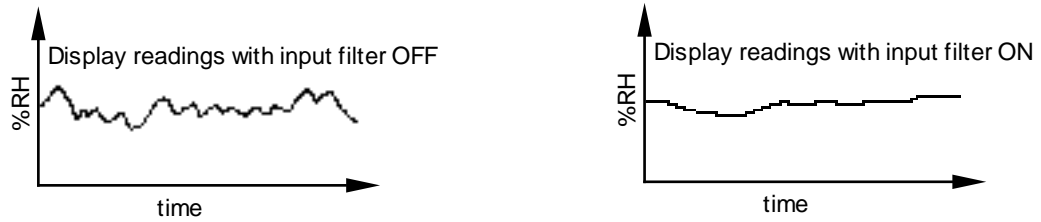

Figure 8.13a - Display readings with input filtering.

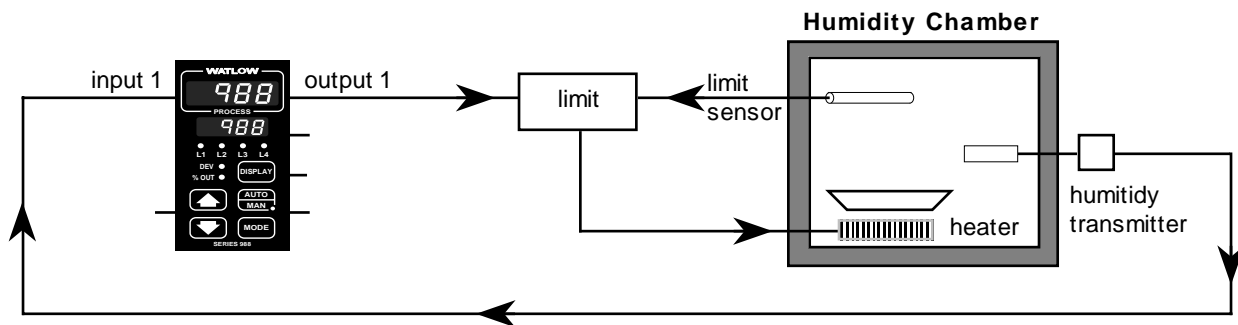

Figure 8.13b - Humidity chamber with input filtering.

Sample Application

A Series 988 controls the humidity in an environmental chamber. The relative humidity (RH) sensor provides a 4-20mA signal over a 0-100% RH range. The sensor is very sensitive to changes caused by air flow in the chamber. The turbulence in the chamber makes the controller display jump two to three percent. To remove this display dithering set the filter time constant **FEr1** for input 1 to two seconds. This will smooth the display and provide a more realistic reading.

Input Linearization

Requirements

The square root extraction feature is standard on any Series 988 controller with universal signal conditioner inputs. The linearization prompt will appear if a process input is selected with the DIP switches (see Chapter 1).

Overview

In many flow applications the output signal from a flow transmitter represents a squared value of the actual flow. The square root must be extracted from the signal to make it useful to the operator. Many flow transmitters offer this feature in the transmitter itself, but this can add significantly to the cost. Using the square root extraction option in the Series 988 controller can save the operator money. The feature is enabled simply by setting input 1 linearization `[Lin1]` or input 2 linearization `[Lin2]` to square root extraction `[root]`.

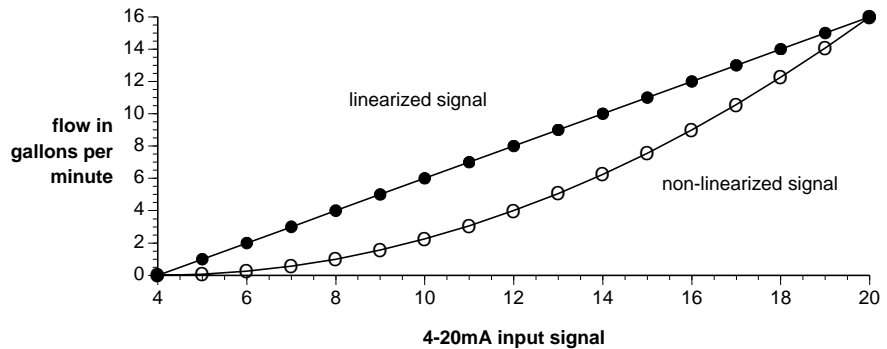

Figure 8.15a - Graph of linearized signal.

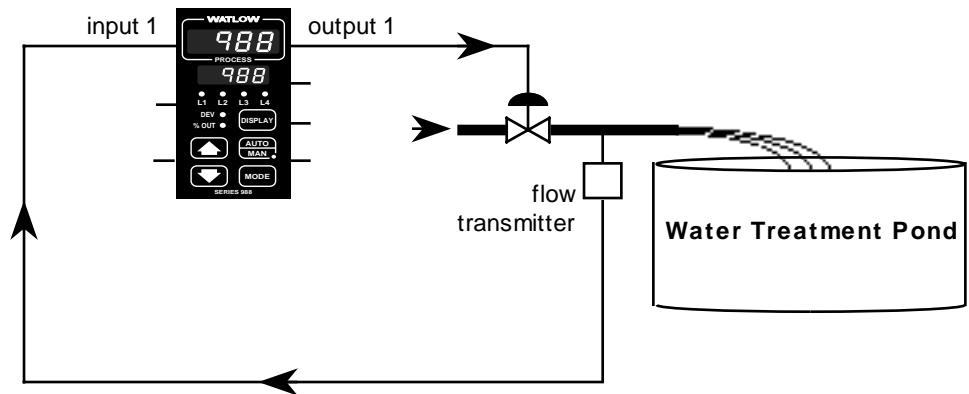

Figure 8.15b - Waste-water treatment with input linearization.

Sample Application

A waste water process engineer needs to control the flow of a solution to be mixed with wastewater to treat it. The transmitter provides a 4-20mA output without square root extraction. The engineer used the Series 988 with a universal signal conditioner input and a 4-20mA process output to control the flow. The input signal was linearized using the square root extraction feature of the 988.

The above system has a flow range of 0 to 16 gallons per minute. The range low and range high parameters for input 1 would be set to 0 and 16 respectively. The input 1 linearization prompt `[Lin]` would then be set to square root extraction `[root]`. You can see from the above graph that without square root extraction to linearize the signal it would not be useful for controlling the process.

Ramp To Set Point

Requirements

This feature is standard on all units.

Overview

Ramp to set point enables the Series 988 to ramp the set point at a user-defined rate. This allows the controller to start up a system or change between set points at a rate that will not stress the product or system components. The ramp rate is defined in degrees per minute. Ramp to set point can be initiated at start up only, or at start up and also on any set point changes.

When a ramp is initiated, the starting point for the ramp is the current process value. If the ramp is initiated on start up, the Series 988 looks at the process value upon power up, and uses that value as the starting point for the ramp. If a set point change initiates the ramp to set point function, the controller looks at the process value when the change is made and uses that value as the starting point for the ramp. If the set point is changed during a ramp, the process value at the time of the change becomes the starting point for the new ramp.

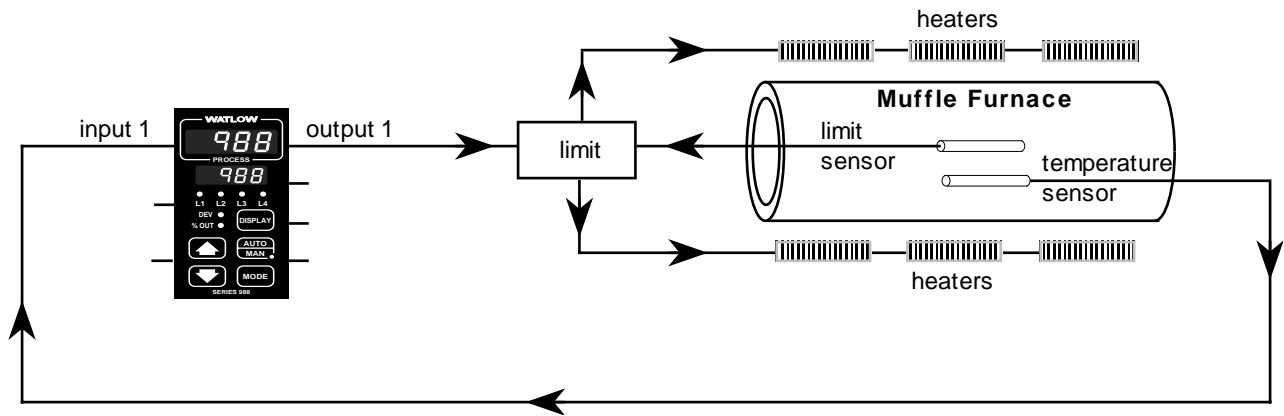

Figure 8.17 -
Muffle furnace with
ramp to set point.

Sample Application

An engineer needs to control the temperature of a muffle furnace. The furnace set point must be ramped up at a defined rate to prevent stressing the muffle and other system components. By enabling the ramp to set point function in the Series 988, the engineer can control the rate at which the set point will rise. Ramp to set point is enabled in the Global Menu using the Ramping Function prompt `[rP]`. To ramp on start up only, select start `[SErE]`. To ramp on start up and on any set point changes, select set point `[SEPE]`. The ramp rate `[rRE]` is in degrees per minute.

For further protection of the system, output 2, 3 or 4 can be configured as a rate alarm, monitoring the rate of increase or decrease in the process variable on input 1. The Alarm Low `[R2LO]` and Alarm High `[R2H1]` prompts (The “2” in these examples refers to output 2.) establish the ramp-down and ramp-up rate set points, respectively, in degrees per minute.

Remote Set Point

Requirements

Input 2 must be either a thermocouple (98__-1__-__-__-__) or universal signal conditioner (98__-2__-__-__-__).

NOTE:

Make sure all input and output impedances are compatible.

To use a Series 988 as a master controller, choose one of the retransmit options for output 3 of the master (98__-__-__-__-M__-__ for 0-20mA or 4-20mA; or 98__-__-__-__-N__-__ for 0-5V_{DC}, 1-5V_{DC} or 0-10V_{DC}).

Overview

The remote set point feature allows the Series 988 to use a thermocouple, RTD or process signal at input 2 to establish the set point. This feature gives the Series 988 the ability to have its set point value manipulated by an external source. A common application would use one ramping controller with a set-point retransmit output to ramp multiple controllers using the remote set point. Or you could use an analog output from a PLC to send set point values to a Series 988.

NOTE:

Input 1 and 2 are not isolated from each other.

You may select between local and remote set points at the front panel, with an event input, from a remote computer using the communications feature or from an external switch using an event input.

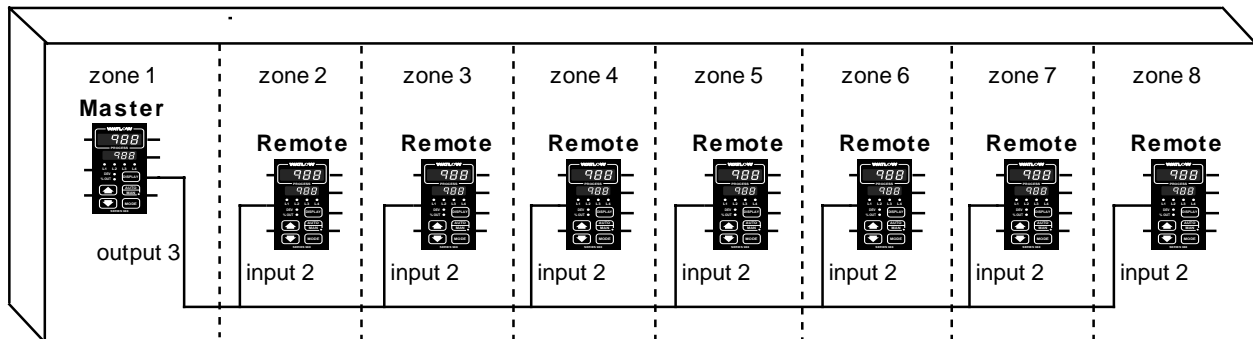

Figure 8.19 - Zone heating with remote set point.

Sample Application

An engineer has a machine with eight independent zones of heat. He wants to change set points on all zones without having to adjust each control individually. This can be achieved using a Series 988 with a 0-5V_{DC} retransmit output as the master controller. The seven remote 988s will use the 0-5V_{DC} signal on input 2 as a remote set point. When the set point is changed on the master controller, the retransmit output changes the set points of the seven remote controllers. By enabling the ramp to set point feature in the master controller, all eight zones are ramped up to set point at a user-defined rate on power up.

The retransmit output from the master Series 988 is set so that 0V_{DC} represents 0°F and 5V_{DC} represents 800°F. On the remote controllers, set the input 2 DIP switch to the position for the 0-5, 1-5, 0-10V_{DC} process input. In the Input Menu, under the Input 2 prompt `[In2]`, select 0-5. The Remote Set Point prompt `[rSP]` should be set to ON `[on]` and decimal 2 `[DEC2]` set to 0. The range low 2 `[rL2]` and the range high 2 `[rH2]` parameters will establish the scaling for the remote set point input. Range low 2 `[rL2]` should be set to 0 and range high 2 `[rH2]` should be set to 800. To operate a specific zone ten degrees hotter than the others, increase the range low 2 `[rL2]` to 10 and the range high 2 `[rH2]` to 810.

With remote set point `[rSP]` enabled and local `[L]` selected under the Local-remote prompt `[L-r]` in the System Menu, the set point is adjusted using the up-arrow and down-arrow keys. Selecting remote `[r]` under the Local-remote prompt `[L-r]`, disables the up-arrow and down-arrow keys, allowing the set point value to be manipulated by the input 2 signal.

Retransmit

Requirements

Output 3 is used for the retransmit option. Choose either a milliamp (98_ _-_-_-M_ __) or a voltage (98_ _-_-_-N_ __) signal. Select the output range in the Output Menu.

Overview

The retransmit feature can be used to transmit an analog signal representing the value of either input process variable or the target set point variable. The retransmit signal is factory configured as either a milliamp (98_ _-_-_-M_ __) or a voltage (98_ _-_-_-N_ __) signal. In choosing the type of retransmit signal the operator must take into account the input impedance of the device to be retransmitted to and the required signal type, either voltage or milliamps.

Typically applications might use the retransmit option to record one of the variables with a chart recorder or to generate a set point for other controls in a multi-zone application (see page 8.19).

NOTE:
Enhanced software
is not required for
this feature.

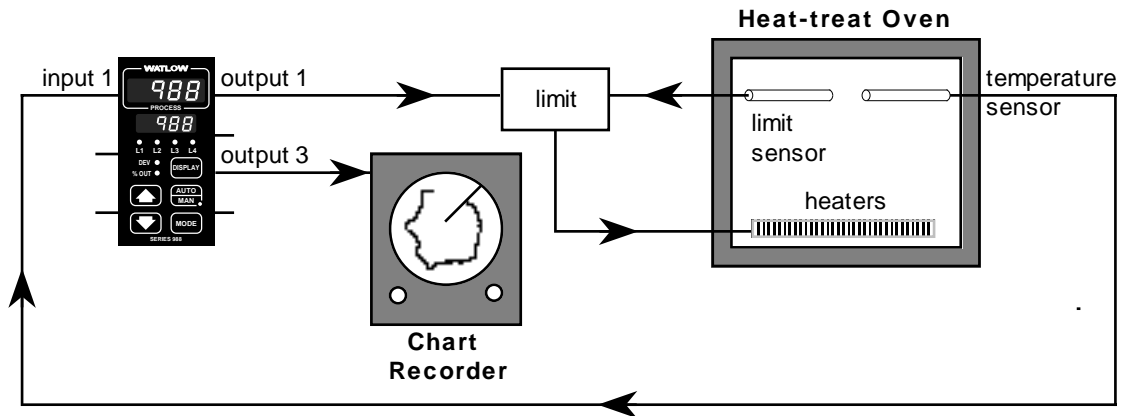

Figure 8.21 - Heat-treat oven with retransmit.

Sample Applications

A Series 988 is being used to control the temperature of a heat-treat oven. The temperature of the process must be recorded on a chart recorder. The oven temperature range stays between 600° and 900° F. The chart recorder requires a 4-20mA signal.

In the Output Menu **[OUP]** set analog output **[Rout]** to **[Prc I]** to tag the input 1 process value as the parameter to be retransmitted. Set retransmit low limit **[ArL]** to 600 to set the low range for the retransmit signal to 600. Set retransmit high limit **[ArH]** to 900 to set the high range for the retransmit signal to 900. Set retransmit calibrate offset **[ACAL]** to 0, assuming there is no calibration offset required.

The retransmit output will be 4mA until the oven temperature is greater than 600 degrees F, at which point the signal will increase with temperature to 20mA at 900° F and will not exceed 20mA.

Slidewire Feedback

Requirements

A slidewire configuration uses at least two inputs and two control outputs. Input 2 can only be selected as a slidewire input (98_ _-3_ _- _ _ _).

NOTE:

Outputs must be compatible with the slidewire valve actuators.

Overview

The Series 988 can control the position of a valve with a slidewire feedback position indicator. The controller senses the resistance of the slidewire and compares it to the range low and range high settings to determine the valve position. The controller compares this to the percent output and takes action to match the two by opening or closing the valve.

Set the hunt `hunt` parameter to limit valve hunting. The value is set for the percent of output (0.0 to 100.0). When the valve is within this dead band, a change in output greater than half the hunt parameter is required to trigger action. Output 1 responds to “close” commands and output 2 responds to “open” commands.

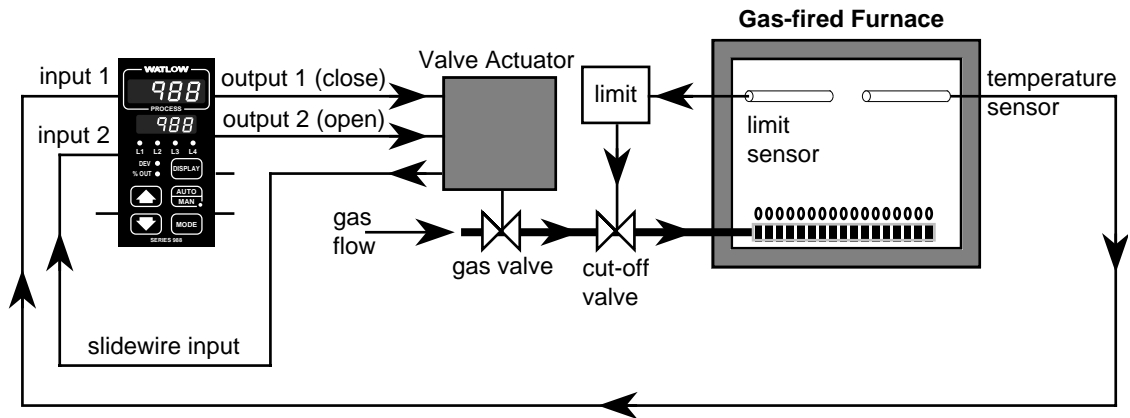

Figure 8.23 - Gas-fired furnace with slidewire feedback.

Sample Application

A Series 988 controls the gas valve for a gas-fired furnace to heat treat large metal parts. First the controller must be “married” to the slidewire feedback from the valve actuator. To do this, first set the Input 2 prompt `[In2]` to slidewire `[SLid]`. Advance to the Learn Low Resistance prompt `[Lrnl]`. Close the valve manually to the minimum resistance reading from the slidewire. Select `[YES]` in the upper display and press the Mode key `[MODE]` to advance to the Learn High Resistance prompt `[Lrnh]`. Manually open the valve (maximum slidewire resistance). Select `[YES]` in the upper display and press the Mode key `[MODE]`. At this point both the high and low resistance values have been learned and stored in the range low 2 and range high 2 parameters.

You can also manually set the range low and range high values. From the slidewire specifications, determine the low and high resistance values and enter these at the Range Low `[rL2]` and Range High `[rH2]` prompts.

Once the control is operating, adjust the hunt `[hunt]` parameter, to minimize valve oscillations. The hunt parameter sets up a dead band on both sides of the current valve position. The desired valve position is then compared to the actual position. If the difference is greater than the one-half of the hunt value, the Series 988 repositions the valve to achieve the temperature set point. Once repositioning is complete, the dead band is recalculated for the new valve position.

Appendix

Glossary	A.2
Specifications	A.4
Warranty and Returns	A.5
Index	A.6
Menu Overview	A.10
Model Number	A.11
Declaration of Conformity	A.12

Glossary, A - L

annunciator — A visual display that uses pilot lights to indicate the former or existing condition of several items in a system.

bumpless transfer — A smooth transition from auto (closed loop) to manual (open loop) operation. The control output(s) does not change during the transfer.

burst fire — A power control method that repeatedly turns on and off full ac cycles. Also called zero-cross fire, it switches close to the zero-voltage point of the ac sine wave. Variable-time-base burst fire selectively holds or transits ac cycles to achieve the desired power level.

calibration offset — An adjustment to eliminate the difference between the indicated value and the actual process value.

cascade — Control algorithm in which the output of one control loop provides the set point for another loop. The second loop, in turn, determines the control action.

closed loop — A control system that uses a sensor to measure a process variable and makes decisions based on that feedback.

cold junction — See junction, cold.

cold junction compensation — Electronic means to compensate for the effective temperature at the cold junction.

current transformer — A transformer designed for measuring electrical current.

dead band — The range through which a variation of the input produces no noticeable change in the output. In the dead band, specific conditions can be placed on control output actions. Operators select the dead band. It is usually above the heating proportional band and below the cooling proportional band.

default parameters — The programmed instructions that are permanently stored in the microprocessor software.

derivative — The rate of change in a process variable. Also known as rate. See PID.

Deutsche Industrial Norm (DIN) — A set of technical, scientific and dimensional standards developed in Germany. Many DIN standards have worldwide recognition.

DIN — See Deutsche Industrial Norm.

droop — In proportional controllers, the difference between set point and actual value after the system stabilizes.

duty cycle — The percentage of a cycle time in which the output is on.

external signal conditioner power supply — A dc voltage source that powers external devices.

filter —

digital filter (DF) — A filter that slows the response of a system when inputs change unrealistically or too fast. Equivalent to a standard resistor-capacitor

(RC) filter.

digital adaptive filter — A filter that rejects high frequency input signal noise (noise spikes).

heat/cool output filter — A filter that slows the change in the response of the heat or cool output. The output responds to a step change by going to approximately 2/3 its final value within the number of scans that are set.

form A — A single-pole, single-throw relay that uses only the normally open (NO) and common contacts. These contacts close when the relay coil is energized. They open when power is removed from the coil.

form B — A single-pole, single-throw relay that uses only the normally closed (NC) and common contacts. These contacts open when the relay coil is energized. They close when power is removed from the coil.

form C — A single-pole, double-throw relay that uses the normally open (NO), normally closed (NC) and common contacts. The operator can choose to wire for a Form A or Form B contact.

hunting — Oscillation of process temperature between the set point and the process variable.

hysteresis — A change in the process variable required to re-energize the control or alarm output. Sometimes called switching differential.

integral — Control action that automatically eliminates offset, or droop, between set point and actual process temperature. See reset, automatic.

isolation — Electrical separation of sensor from high voltage circuitry. Allows use of grounded or ungrounded sensing element.

Joint Industrial Standards (JIS) — A Japanese agency that establishes and maintains standards for equipment and components. Also known as JISC (Japanese Industrial Standards Committee), its function is similar to Germany's Deutsche Industrial Norm (DIN).

JIS — Joint Industrial Standards.

junction — The point where two dissimilar metal conductors join to form a thermocouple.

cold junction — Connection point between thermocouple metals and the electronic instrument. See reference junction.

grounded junction — Type of thermocouple probe in which the hot, or measuring junction, is an integral part of the sheath material. No electrical isolation is provided.

isolated junction — A form of thermocouple probe construction in which the measuring junction is fully enclosed in a protective sheath and electrically isolated from it. Commonly called an ungrounded junction.

reference junction — The junction in a thermocouple circuit held at a stable, known temperature (cold junction). Standard reference temperature is 32°F (0°C).

thermocouple junction — The point where the two dissimilar metal conductors join. In a typical thermocouple circuit, there is a measuring junction and a reference junction. See reference junction.

ungrounded junction — See isolated junction.

linearization, square root — The extraction of a linear signal from a nonlinear signal corresponding to the measured flow from a flow transmitter. Also called square root extraction.

Modbus (RTU) — Remote Terminal Unit.

NEMA 4X — A NEMA specification for determining resistance to moisture infiltration. This rating certifies the controller as washable and corrosion resistant.

on/off — A method of control that turns the output full on until set point is reached, and then off until the process error exceeds the hysteresis.

open loop — A control system with no sensory feedback.

output — Control signal action in response to the difference between set point and process variable.

overshoot — The amount by which a process variable exceeds the set point before it stabilizes.

P control — Proportioning control.

PD control — Proportioning control with derivative (rate) action.

PDR control — Proportional derivative control with manual reset, used in fast responding systems where the reset causes instabilities. With PDR control, an operator can enter a manual reset value that eliminates droop in the system.

PI control — Proportioning control with integral (automatic reset) action.

PID — Proportional, integral, derivative. A control mode with three functions: proportional action dampens the system response, integral corrects for droop, and derivative prevents overshoot and undershoot.

process variable — The parameter that is controlled or measured. Typical examples are temperature, relative humidity, pressure, flow, fluid level, events, etc. The high process variable is the highest value of the process range, expressed in engineering units. The low process variable is the lowest value of the process range.

proportional band (PB) — A range in which the proportioning function of the control is active. Expressed in units, degrees or percent of span. See PID.

proportional control — A control using only the P (proportional) value of PID control.

rate band — A range in which the rate function of a controller is active. Expressed in multiples of the proportional band. See PID.

ratio — A method by which the controller measures the flow of an uncontrolled variable and uses a proportion of it to control the flow of a second variable.

reference junction — See junction.

reset — Control action that automatically eliminates offset, or droop, between set point and actual process tem-

perature. Also see integral.

automatic reset — The integral function of a PI or PID temperature controller that adjusts the process temperature to the set point after the system stabilizes. The inverse of integral.

automatic power reset — A feature in latching limit controls that does not recognize power outage as a limit condition. When power is restored, the output is re-energized automatically, as long as the temperature is within limits.

manual reset — 1) A feature on a limit control that requires human intervention to return the limit to normal operation after a limit condition has occurred. 2) The adjustment of a proportional control to raise the proportional band to compensate for droop.

no key reset — A method for resetting the controller's memory (for instance, after an EPROM change).

resistance temperature detector (RTD) — A sensor that uses the resistance temperature characteristic to measure temperature. There are two basic types of RTDs: the wire RTD, which is usually made of platinum, and the thermistor, which is made of a semiconductor material. The wire RTD is a positive temperature coefficient sensor only, while the thermistor can have either a negative or positive temperature coefficient.

retransmit output — An analog output signal that may be scaled to represent the process value or set point value.

RTD — See resistance temperature detector.

slidewire feedback — A method of controlling the position of a valve. It uses a potentiometer to vary resistance and indicate position of the valve.

switching sensitivity — In on/off control, the temperature change necessary to change the output from full on to full off. See hysteresis.

thermal system — A regulated environment that consists of a heat source, heat transfer medium or load, sensing device and a control instrument.

thermocouple (t/c) — A temperature sensing device made by joining two dissimilar metals. This junction produces an electrical voltage in proportion to the difference in temperature between the hot junction (sensing junction) and the leadwire connection to the instrument (cold junction).

thermocouple break protection — The ability of a control to detect a break in the thermocouple circuit and take a predetermined action.

three-mode control — Proportioning control with integral (reset) and derivative (rate). Also see PID.

time proportioning control — A method of controlling power by varying the on/off duty cycle of an output. This variance is proportional to the difference between the set point and the actual process temperature.

zero cross — Action that provides output switching only at or near the zero-voltage crossing points of the ac sine wave. See burst fire.

zero switching — See zero cross.

Specifications

(1234)

Control Mode

- Dual input, quad output, optional retransmit of set point or process variable.
- Programmable direct and reverse acting control outputs.
- One-step auto-tuning.

Operator Interface

- Local/remote set point capability.
- Dual, 4-digit LED displays: upper, 0.4" (10mm); lower, 0.3" (8mm).
- Mode, Auto/Man, Display, Up and Down keys.

Input

- Contact input for software function select.
- Type J, K, T, N, C(W5)₂, D(W3)₂, E, R, S, B, Pt 2₂ thermocouple, 1° or 0.1° RTD.
- 0-50mV_≐ (dc), 0-20mA, 4-20mA, 0-5V_≐ (dc), 1-5V_≐ (dc), 0-10V_≐ (dc) process.
- Slidewire, digital event input or heater current options.
- Sensor break protection de-energizes control output to protect system or selectable bumpless transfer to manual operation. Latching or non-latching.
- °F or °C display or process units, user selectable.

Sensor Ranges

J t/c:	32 to 1500°F	or	0 to 816°C
K t/c:	-328 to 2500°F	or	-200 to 1371°C
T t/c:	-328 to 750°F	or	-200 to 399°C
N t/c:	32 to 2372°F	or	0 to 1300°C
R t/c:	32 to 3200°F	or	0 to 1760°C
S t/c:	32 to 3200°F	or	0 to 1760°C
B t/c:	1598 to 3300°F	or	870 to 1816°C
E t/c:	-328 to 1470°F	or	-200 to 799°C
C t/c (W5) ₂ :	32 to 4200°F	or	0 to 2316°C
D t/c (W3) ₂ :	32 to 4200°F	or	0 to 2316°C
Pt 2 ₂ :	32 to 2543°F	or	0 to 1395°C
1°RTD (JIS):	-328 to 1166°F	or	-200 to 630°C
1°RTD (DIN):	-328 to 1472°F	or	-200 to 800°C
0.1°RTD (JIS and DIN):	-99.9 to 999.9°F	or	-73.3 to 537.7°C
0-5V _≐ (dc):	-999 to 9999		
1-5V _≐ (dc):	-999 to 9999		
0-10V _≐ (dc):	-999 to 9999		
0-20mA:	-999 to 9999		
4-20mA:	-999 to 9999		
0-50mV _≐ (dc):	-999 to 9999		
Slidewire:	100 to 1200Ω		
Current:	0 to 50A		
Potentiometer:	0 to 1200Ω		

Output Options

- Solid-state relay, 0.5A @ 24V_~ (ac) min., 253V_~ (ac) max., opto-isolated, burst fire. With or without contact suppression.
- Open collector: Max. voltage 42V_≐ (dc), max. current 1A.
- Switched dc signal: Min. turn-on voltage of 3V_≐ (dc) into min. 500Ω load; max. On voltage not greater than 32V_≐ (dc) into an infinite load, isolated.
- Electromechanical relay₁, Form C, 5A @ 120/240V_~ (ac), 6A @ 28V_≐ (dc), 1/8 hp. @ 120V_~ (ac) or 125VA @ 120V_~ (ac). With or without contact suppression. Off-state output impedance with RC suppression is 20kΩ.

- Process, 0-20mA, 4-20mA into 800Ω maximum, 0-5V_≐ (dc), 1-5V_≐ (dc) or 0-10V_≐ (dc) into 1kΩ minimum₁, reverse acting, isolated.
- Electromechanical relay, Form A/B, 5A @ 120/240V_~ (ac), 6A @ 28V_≐ (dc), 1/8 hp. @ 120V_~ (ac) or 125VA @ 120V_~ (ac). Without contact suppression.
- External transmitter power supply, 5V ±5% @ 30mA, 12V ±5% @ 30mA or 20V ±5% @ 30mA.
- EIA/TIA-232 communications or EIA/TIA-485, EIA/TIA-422 communications, opto-isolated.

Accuracy

- Calibration accuracy and sensor conformity: ± 0.1% of span, ±1 LSD, 77°F ± 5°F (25°C ± 3°C) ambient and rated line voltage ±10%.
- Accuracy span: 1000°F (540°C) minimum.
- Temperature stability: ± 0.2°F/°F (0.1°C/°C) change in ambient.
- Voltage stability: ± 0.01% of span /% of rated line voltage.

Agency Approvals

- UL, C-UL File #43684
- CE: 89/336/EEC Electromagnetic Compatibility Directive.
EN 50081-2: 1994 Emissions.
EN 50082-2: 1995 Immunity.
- 73/23/EEC Low-Voltage Directive.
EN 61010-1: 1993 Safety.
- NEMA 4X

Terminals

- #6 compression universal head screws (tighten to 5 inch/pounds maximum), accepts 20-14 gauge wire.

Line Voltage/Power

- 100 to 240V_~ ₁ (ac) +10%/-15%, 50/60Hz, ± 5%.
- 24 to 28V_≐ ₁ (ac/dc) +10%/-15%, 50/60Hz, ±5%.
- 16VA maximum.
- Fused internally (factory replaceable only) Slo-Blo® type (time-lag): 2A, 250V for high-voltage versions; 5A, 250V for low-voltage versions.
- Non-volatile memory retains data if power fails.

Operating Environment

- 32 to 149°F (0 to 65°C), 0 to 90% RH, non-condensing.

Storage Temperature

- -40 to 185°F (-40 to 85°C).

Mechanical

- 1/8 DIN panel mount, NEMA 4X (IP65 equivalent) front panel.
- Overall width x height x depth:
horizontal - 4.03" x 2.18" x 4.74"
(102mm x 55mm x 120mm);
vertical - 2.18" x 4.03" x 4.74"
(55mm x 102mm x 120mm).
- Depth behind panel; 4.06" (103mm).
- Weight: less than or equal to 14.0oz (0.40kg).

Sample/Update Rates

- 1 input: 10Hz.
- 2 inputs: 5Hz.
- Retransmit: 1Hz.
- Remote set point: 1Hz.
- PID: 10Hz.
- Outputs: 10Hz.
- Display: 2Hz.
- Alarm Outputs: 1 Hz

Resolution

- Inputs: 16 bits.
- Outputs: 12 bits.

¹ Electromechanical relays are warranted for 100,000 closures only. Solid-state switching devices are recommended for applications requiring fast cycle times or extended service life.

² Not an ANSI symbol.



Warranty

The Watlow Series 988 is warranted to be free of defects in material and workmanship for 36 months after delivery to the first purchaser for use, providing that the units have not been misapplied. Since Watlow has no control over their use, and sometimes misuse, we cannot guarantee against failure. Watlow's obligations hereunder, at Watlow's option, are limited to replacement, repair or refund of purchase price, and parts which upon examination prove to be defective within the warranty period specified. This warranty does not apply to damage resulting from transportation, alteration, misuse or abuse.

Watlow Controls

Watlow Controls is a division of Watlow Electric Mfg. Co., St. Louis, Missouri, a manufacturer of industrial electric heating products since 1922. Watlow begins with a full set of specifications and completes an industrial product that is manufactured totally in-house, in the U.S.A. Watlow products include electric heaters, sensors, controls and switching devices. The Winona operation has been designing solid state electronic control devices since 1962, and has earned the reputation as an excellent supplier to original equipment manufacturers. These OEMs depend upon Watlow Controls to provide compatibly engineered controls which they can incorporate into their products with confidence. Watlow Controls resides in a 100,000-square-foot marketing, engineering and manufacturing facility in Winona, Minnesota.

Returns

1. Call Watlow Customer Service, (507) 454-5300, for a Return Material Authorization (RMA) number before returning any item for repair. We need this information:
 - Ship to address
 - Contact name
 - Ship via
 - Symptoms and/or special instructions
 - Name and phone number of person returning the material.
 - Bill to address
 - Phone number
 - Your P.O. number
2. Prior approval and an RMA number, from the Customer Service Department, is needed when returning any unused product for credit. Make sure the RMA number is on the outside of the carton, and on all paperwork returned. Ship on a Freight Prepaid basis.
3. After we receive your return, we will examine it and determine the cause for your action.
4. In cases of manufacturing defect, we will enter a repair order, replacement order, or issue credit for material. A 20-percent restocking charge is applied for all returned stock controls and accessories.
5. If the unit is unrepairable, it will be returned to you with a letter of explanation. Repair costs will not exceed 50 percent of the original cost.

Shipping Claims

When you receive your Watlow control, examine the package for any signs of external damage it may have sustained enroute. If there is apparent damage either outside the box or to its contents, make a claim with the shipper immediately. Save the original shipping carton and packing material.

Index a-h

- %OUT LED 3.1
- 0-5V \approx (dc) process wiring
 - input 1 2.8
 - input 2 2.9
 - output 1 2.12
 - output 2 2.13
- 0-10V \approx (dc) process wiring
 - input 1 2.8
 - input 2 2.9
 - output 1 2.12
 - output 2 2.13
- 0-20mA process wiring
 - input 1 2.8
 - input 2 2.9
 - output 1 2.12
 - output 2 2.13
- 0-50mV (high impedance) wiring
 - input 1 2.8
 - input 2 2.9
- 1-5V \approx (dc) process wiring
 - input 1 2.8
 - input 2 2.9
 - output 1 2.12
 - output 2 2.13
- 4-20mA process wiring
 - input 1 2.8
 - input 2 2.9
 - output 1 2.12
 - output 2 2.13

A

- access to panel back 2.2
- ac output wiring
 - output 1 2.12
 - output 2 2.13
 - output 3 2.14
 - output 4 2.15
- address 4.46
- alarm
 - deviation 7.6
 - process 7.6
 - rate 7.7
- alarm 2 4.23
- alarm 2 high 5.5
- alarm 2 low 5.4
- alarm 2 side 4.23
- alarm 3 4.25
- alarm 3 high 5.6
- alarm 3 low 5.5
- alarm 3 side 4.26
- alarm 4 4.28
- alarm 4 high 5.7
- alarm 4 low 5.6
- alarm 4 side 4.29
- alarm display, masked 7.6
- alarm high 5.2
- alarm jumper, changing 7.5
- alarm low 5.2
- alarm reset 8.8
- alarms 7.5 - 7.7
- alarms, latching 7.7
- alarms, non-latching 7.7
- alarm silencing 7.7
- algorithm 4.38
- ambient temperature 6.3
- analog output 4.31
- annunciator 4.41, A.2
- Auto/Manual key 3.1, 7.4
- Auto/Manual LED 3.1, 7.4
- auto/manual operation 7.4, 8.8
- automatic operation 7.4
- auto-tune 5.7
- auto-tune set point 4.42
- auto-tuning 7.1

B

- baud rate 4.45, 8.4
- brackets 2.1 - 2.3
- bumpless transfer 4.35, 7.4
- burst fire 8.1 - 8.3, A.2

C

- calibration curve, RTD 2 4.14
- calibration manual ii
- Calibration Menu 6.13 - 6.14
 - lockout 6.6
- calibration offset A.2
- calibration offset 1 4.6
- calibration offset 2 4.14
- calibration offset adjustment 7.3
- cascade control A.2
- cascade action 4.37
- cautions iii
- Celsius 4.35
- clearing error codes 7.10
- closed loop A.2
- cold junction A.2
- communications 8.4 - 8.5
- Communications Menu 4.44 - 4.48, 8.4
 - lockout 6.6
- compression molding press 8.11
- consumer feedback iii
- controller chassis, removing 1.1, 7.5
- controlling output action 8.8
- control outputs off 8.8
- control type 4.36
- crossover process value 4.39
- crossover set point value 4.39
- current 8.10
- current transformer 8.11, A.2
- current transformer input 2.10
- current transformer wiring 2.10
- cycle time
 - output 1 5.13
 - output 2 5.16
- cycle time adjustment 7.3

D

- data bits & parity 4.45, 8.4
- data communications ii, 2.15, 4.1, 8.4
- Data Communications with the Watlow Series 988 Family of Controllers* ii, 2.15, 4.1, 4.44
- date 6.3
- dead band 5.16, 8.6 - 8.7
 - sample application 8.7
- decimal 1 4.4
- decimal 2 4.11
- decimal point, location of 4.3, 4.35
- Declaration of Conformity A.12
- default 6.14, A.2
- derivative A.2
 - output 1 5.12
 - output 2 5.15
- deviation alarm 7.6
- device address 8.4
- DEV LED (set point deviation) 3.1
- Diagnostics Menu 6.7 - 6.12
 - lockout 6.6
- digital event input options 8.8 - 8.9
- digital event wiring
 - input 1 2.11
 - input 2 2.10
- dimensions 2.1
- DIN A.2
- DIP switch functions 1.1 - 1.4
- DIP switch locations 1.1 - 1.4

- DIP switch setting
 - input 1.2
 - lockout 1.4
 - output 1.3
- display 6.11
- Display Key 3.1
- Display Loop 3.2
- displays 3.1
- documentation, maintaining ii, 6.9
- Down-arrow Key 3.1
- droop A.2
- dual in-line package (DIP) switches 1.1 - 1.4
- duty cycle A.2

E

- environmental chamber 8.7
- error code messages 7.8
- error code results 7.10
- error codes, clearing 7.10
- error latching 4.36
- event input 1 4.40
- event input 1 Status 5.4
- event input 1 wiring 2.11
- event input 2 4.40
- event input 2 status 5.4
- event input 2 wiring 2.10
- external signal conditioner
 - power supply A.2
 - power supply DIPs 1.3
 - power supply wiring
 - output 2 2.13
 - output 3 2.14
 - output 4 2.15

F

- Factory Menus 6.1 - 6.14
- factory ship date 6.8
- failure mode 4.35
- Fahrenheit 4.35
- feedback iii
- filter time constants 8.12 - 8.13
 - input 1 4.7
 - input 2 4.15
- form A 7.5, A.2
- form B 7.5, A.2
- form C A.2
- front panel 3.1
- front panel lockout 6.3, 8.8

G

- gas-fired furnace 8.23
- Global Menu 4.34 - 4.43
 - lockout 6.5
- Glossary A.2 - A.3
- ground loops 2.4 - 2.5

H

- heater with digital event 8.9
- heater current 8.10 - 8.11
- heat-treat oven 8.21
- high power limit 4.42
- humidity chamber 8.13
- hunt 4.16, 8.22, 8.23
- hunting A.2
- hysteresis A.2
- hysteresis 1 4.20
- hysteresis 2 4.22
- hysteresis 3 4.26
- hysteresis 4 4.29

I

idle set point 5.3, 8.8
input 1 4.3 - 4.8
input 1 wiring 2.8
 0-5V \approx (dc) process 2.8
 0-10V \approx (dc) process 2.8
 0-20mA process 2.8
 0-50mV (high impedance) 2.8
 1-5V \approx (dc) process 2.8
 4-20mA process 2.8
 RTD (2- or 3-wire) 2.8
 thermocouple 2.8
input 2 4.9 -4.16
input 2 wiring 2.9 - 2.10
 0-5V \approx (dc) process 2.9
 0-10V \approx (dc) process 2.9
 0-20mA process 2.9
 0-50mV (high impedance) 2.9
 1-5V \approx (dc) process 2.9
 4-20mA process 2.9
 current transformer input 2.10
 digital event input 2 2.10
 potentiometer input 2.10
 RTD (2- or 3-wire) 2.9
 slidewire feedback 2.10
 thermocouple 2.9
input DIP switches 1.2
 0-5V 1.2
 0-10V 1.2
 0-20mA 1.2
 0-50mV 1.2
 0-50mV (high impedance) 1.2
 1-5 1.2
 4-20mA 1.2
 RTD 1.2
 thermocouple 1.2
input filter 8.12 - 8.13
input linearization 8.14 - 8.15
Input Menu 4.2 - 4.17
 lockout 6.5
input module 6.9
input ranges (tables)
 input 1 4.5 - 4.6
 input 2 4.12
input-to-output isolation 2.4, 2.13 - 2.15
installation 2.1 - 2.3
integral A.2
 output 1 5.11
 output 2 5.14
interface type 4.47
isolation 2.4, A.2

J

JIS A.2
jumper location 7.5
junctions A.2

K

keys 3.1

L

L1 (output 1) 3.1
L2 (output 2) 3.1
L3 (output 3) 3.1
L4 (output 4) 3.1
latching 2 4.24
latching 3 4.27
latching 4 4.30
latching alarm 7.7
learn high range 4.13
learn low range 4.13

linearization A.2
linearization, input 8.14 - 8.15
linearization 1 4.8
linearization 2 4.15
local-remote 5.8
locating DIP switches 1.1 - 1.4
Lockout, Panel Menu 6.2 - 6.6
lockout DIP switch 1.4
lockout level, setting 6.2 - 6.6
loop error detect 8.10
lower display 3.1
low power limit 4.41

M

maintaining documentation ii, 6.9
manual operation 7.4
manual tuning 7.2
mechanical relay 7.2
menu lockout 6.2 - 6.6
Mode Key 3.1, 8.23
Modbus 8.4
model number ii, iii, A.11
module types 6.9 - 6.10
mounting 2.1 - 2.3
muffle furnace 8.17

N

National Electric Code (NEC) 2.4, 2.6, 2.7
NEMA 4X seal 2.3, A.2
non-latching alarm 7.7
notes iii

O

on/off control A.2
Operation Menus 5.1 - 5.16
operation parameters, manual tuning 7.2
open loop 6.12, A.2
ordering information A.5
output A.2
output 1 4.19
output 1 wiring 2.12
 0-5V \approx (dc) process 2.12
 0-10V \approx (dc) process 2.12
 0-20mA process 2.12
 1-5V \approx (dc) process 2.12
 4-20mA process 2.12
 ac outputs 2.12
 switched dc, open collector 2.12
output 2 4.21
output 2 wiring 2.13
 0-5V \approx (dc) process 2.13
 0-10V \approx (dc) process 2.13
 0-20mA process 2.13
 1-5V \approx (dc) process 2.13
 4-20mA process 2.13
 ac outputs 2.13
 external transmitter power supply 2.13
 switched dc, open collector 2.13
output 3 4.25
output 3 wiring 2.14
 ac outputs 2.14
 external transmitter power supply 2.14
 process retransmit 2.14
 switched dc, open collector 2.14
output 4 4.28
output 4 wiring 2.15
 ac outputs 2.15
 external transmitter power supply 2.15
 switched dc, open collector 2.15
output configurations
 output 1 (control) 3.1
 output 2 (control or alarm) 3.1

 output 3 (alarm or retransmit) 3.1
 output 4 (alarm or communications) 3.1
output DIP switches 1.3
Output Menu 4.18 - 4.33
 lockout 6.5
output module types 6.10
output power supply
 output 2 2.13
 output 3 2.14
 output 4 2.15
overriding alarms 7.7
overshoot A.3

P

P control A.3
panel back access 2.2
panel cutouts 2.1 - 2.2
Panel Lockout Menu 6.2 - 6.6
PD control A.3
PDR control A.3
PI control A.3
PID 2 crossover selection 4.38
PID control A.3
PID A Menu 5.9 - 5.16
PID B Menu 5.9 - 5.16
PID Menu lockout 6.4
PID parameters 7.1
PID sets, switching 8.8
PLOC Menu 6.2
potentiometer wiring 2.10
power supply (see external signal conditioner)
 DIP switches 1.3
 output 2 2.13
 output 3 2.14
 output 4 2.15
power wiring 2.4
process variable A.3
process 1 4.20
process 2 4.21
process 3 4.31
process alarm 7.6
process retransmit wiring 2.14
process value, 8.16
proportional band A.3
 output 1 5.10
 output 2 5.13
proportional band adjustment 7.3
proportioning control A.3
protocol type 4.46, 8.4

Q, R

ramping function 4.43, 8.16
ramp rate 4.43, 8.16
ramp to set point 8.16 - 8.17
range high 1 4.5 - 4.6
range high 2 4.11 - 4.12
range low 1 4.5 - 4.6
range low 2 4.11 - 4.12
rate
 output 1 5.12
 output 2 5.15
rate alarm 7.7, 8.17
rate band A.3
rate/derivative adjustment 7.3
ratio control A.3
reference junction A.2
relay, mechanical 7.2
release tabs 1.1, 2.2 - 2.3, 7.5
remote set point 4.10, 8.8, 8.18 - 8.19
removing controller chassis 1.1, 2.2 - 2.3,
 7.5
reset
 output 1 5.11
 output 2 5.14

reset/integral adjustment 7.3
 restore 6.14
 retransmit 8.20 - 8.21, A.3
 retransmit calibration offset 4.33
 retransmit high limit 4.32
 retransmit low limit 4.32
 RTD A.3
 RTD calibration curve 1 4.7
 RTD calibration curve 2 4.14
 RTD input 2.5
 RTD wiring
 input 1 2.8
 input 2 2.9
 RTU Modbus 8.4

S

safety practices 2.4, 2.6, 2.7
 semiconductor oven 8.3
 sensor installation 2.5
 sensor type
 input 1 4.3
 input 2 4.9 - 4.10
 serial number 6.8
 set point, in tuning 7.2 - 7.3
 set point, ramp to 8.16 - 8.17
 set point 1 3.2
 set point 2 5.1, 5.3
 set point 2 control 4.22
 setting DIP switches 1.1 - 1.4
 input 1.2
 lockout 1.4
 output 1.3
 Setup Menus 4.1 - 4.48
 shipping claims A.5
 silencing 2 4.24
 silencing 3 4.27
 silencing 4 4.30
 silencing alarms 7.7
 slidewire feedback 8.22 - 8.23, A.3
 slidewire feedback wiring 2.10
 slidewire hysteresis 4.16
 software filter 1 4.7
 software filter 2 4.15
 software revision 6.8
 specifications A.4
 square root extraction (linearization,
 square root) 8.14 - 8.15, A.2
 storing data 8.4 - 8.5
 switched dc, open collector wiring
 output 1 2.12
 output 2 2.13
 output 3 2.14
 output 4 2.15
 switching sensitivity A.3
 System Menu 5.1 - 5.8
 lockout 6.4

T

technical assistance iii, 6.10
 temperature limit control protection 2.6
 terminal designation stickers 2.4
 test chambers
 with communications 8.5
 test displays 6.11
 test output 6.11
 thermal system A.3
 thermocouple 2.5, A.3
 thermocouple break protection A.3
 thermocouple wiring
 input 1 2.8
 input 2 2.9

three-mode control A.3
 time constant, filter
 input 1 4.7
 input 2 4.15
 time proportioning control A.3
 tuning
 automatic 7.1 - 7.2
 manual 7.2 - 7.4
 settings 7.2 - 7.3
Tuning of Industrial Control Systems 7.1

U

Up-arrow Key 3.1
 upper display 3.1
 using manual ii - iii

V, W

warnings iii
 warranty A.5
 waste-water treatment 8.15
 wiring 2.1, 2.4 - 2.15
 event input 1 2.11
 event input 2 2.10
 input 1 2.8
 input 2 2.9 - 2.10
 output 1 2.12
 output 2 2.13
 output 3 2.14
 output 4 2.15
 wiring example 2.6
 wiring safety 2.4, 2.6, 2.7

X, Y, Z

zero switching A.3
 zone heating 8.19

Prompt Index

[----] (error) 7.8

A

A2H1 (alarm 2 high) 5.5, 8.17
A2LO (alarm 2 low) 5.4, 8.17
A25d (alarm 2 side) 4.23
A3H1 (alarm 3 high) 5.6
A3LO (alarm 3 low) 5.5
A35d (alarm 3 side) 4.26
A4H1 (alarm 4 high) 5.7
A4LO (alarm 4 low) 5.6
A45d (alarm 4 side) 4.29
ACAL (retransmit calibration offset) 4.33
ACTn (control output action) 8.8
ADDR (device address) 4.46
AL2 (alarm 2) 4.23
AL2n (alarm 2 reverse) 7.6
AL3 (alarm 3) 4.25
AL3n (alarm 3 reverse) 7.6
AL4 (alarm 4) 4.28
AL4n (alarm 4 reverse) 7.6
AL90 (algorithm) 4.38
ALR (alarm reset) 8.8
AMB (ambient temperature) 6.8
ANN (annunciator) 4.41
AOU (analog output) 4.31
ARH (retransmit high limit) 4.32
ARL (retransmit low limit) 4.32
AESP (auto-tune set point) 4.42, 7.1
AUE (auto-tune) 5.7, 7.2

B

BAUD (baud rate) 4.45
BOTh (alarm 3 trigger) 4.26
BPLS (bumpless transfer) 4.35
BRSE (burst fire) 8.2

C

CF (Celsius_Fahrenheit) 4.35
CAL (calibration lockout) 6.6
CAL (Calibration Menu) 6.13
CAL1 (calibration offset 1) 4.6
CAL2 (calibration offset 2) 4.14
CnTL (control type) 4.36
COM (Communications lockout) 6.6
COM (Communications Menu) 4.44, 8.4
CSAC (cascade action) 4.37
CSCd (cascade control) 4.36
CTIA (cycle time, output 1, PID A) 5.13, 8.2
CTIB (cycle time, output 1, PID B) 5.13, 8.2
CT2A (cycle time, output 2, PID A) 5.16, 8.2
CT2B (cycle time, output 2, PID B) 5.16, 8.2
Curr (current) 8.10, 8.11

D

DATA (data bits & parity) 4.45, 8.4
DATE (factory ship date) 6.8
db (dead band) 5.16
db A (dead band PID A) 5.16, 8.6
db B (dead band PID B) 5.16, 8.6
DE1 (deviation alarm input 1) 7.6
DE2 (deviation alarm input 2) 7.6
DE1A (derivative, output 1, PID A) 5.12
DE1B (derivative, output 1, PID B) 5.12
DE2A (derivative, output 2, PID A) 5.15
DE2B (derivative, output 2, PID B) 5.15
DECI (decimal 1) 4.4

dECL2 (decimal 2) 4.11
dFL (default) 6.14
d.M9 (Diagnostics Menu) 6.7
d.R9 (diagnostics lockout) 6.6
d.FF (differential) 4.36
d.r (direct action) 4.37
dISP (test displays) 6.11
dUPL (duplex) 4.38

E

E11 (A/D underflow error) 7.8
E21 (A/D underflow error) 7.8
E12 (sensor under-range error) 7.8
E22 (sensor under-range error) 7.8
E13 (sensor over-range error) 7.8
E23 (sensor over-range error) 7.8
E14 (A/D overflow error) 7.8
E24 (A/D overflow error) 7.8
E.1 (event input 1) 4.40
E.1S (event input 1 status) 5.4
E.2 (event input 2) 4.40 - 4.41
E.2S (event input 2 status) 5.4
Er3 (ambient temperature error) 7.9
Er4 (RAM identification error) 7.9
Er5 (non-volatile checksum error) 7.9
Er9 (configuration error) 7.9
Err (error latching) 4.36

F

FAIL (failure mode) 4.35
Fer1 (software filter 1) 4.7
Fer2 (software filter 2) 4.15
FULL (full) 4.46, 8.4

G

GLBL (Global Menu) 4.34
GLBL (global lockout) 6.5

H

H.9H (alarm 3 trigger) 4.26
H.P (high power limit) 4.42
Hunt (hunt) 4.16, 8.22, 8.23
HYS1 (hysteresis 1) 4.20
HYS2 (hysteresis 2) 4.22
HYS3 (hysteresis 3) 4.26
HYS4 (hysteresis 4) 4.29

I

IdSP (idle set point) 5.3, 8.8
In1 (input 1) 4.3 - 4.4
In2 (input 2) 4.9
InPE (Input Menu) 4.2
InPE (input lockout) 6.5
InEF (interface type) 4.47
IE1A (integral, output 1, PID A) 5.11
IE1B (integral, output 1, PID B) 5.11
IE2A (integral, output 2, PID A) 5.14
IE2B (integral, output 2, PID B) 5.14
IEY1 (input 1 module type) 6.9
IEY2 (input 2 module type) 6.9

J, K, L

LAE (latching) 4.36
LAE2 (latching 2) 4.24
LAE3 (latching 3) 4.27
LAE4 (latching 4) 4.30
L.in1 (input 1 linearization) 4.8, 8.14, 8.15
L.in2 (input 2 linearization) 4.15, 8.14

LOC (front panel lockout) 6.3, 8.8
LoP (low power limit) 4.41
Loop (loop error detect) 8.10
LDLW (alarm 3 trigger) 4.26
L-r (local-remote) 5.8
LrnH (learn high) 4.13, 8.23
LrnL (learn low) 4.13, 8.23

M, N

Mod (Modbus) 4.46
nLH (non-latching) 4.36
no (none) 4.38
nor (normal) 4.36

O

OFF (control outputs off) 8.8
on (on) 8.4, 8.19
OPER (Operation Menus) 5.1 - 5.16
OLP (open loop) 6.12, 7.9
OE1 (output 1) 4.19
OE2 (output 2) 4.21
OE3 (output 3) 4.25
OE4 (output 4) 4.28
OEPE (output lockout) 6.5
OEPE (Output Menu) 4.18
OEY1 (output 1 module type) 6.10
OEY2 (output 2 module type) 6.10
OEY3 (output 3 module type) 6.10
OEY4 (output 4 module type) 6.10

P

Pb1A (proportional band, output 1, PID A) 5.10
Pb1B (proportional band, output 1, PID B) 5.10
Pb2A (proportional band, output 2, PID A) 5.13
Pb2B (proportional band, output 2, PID B) 5.13
P.id (switch PID sets) 4.38, 8.8
P.id2 (PID 2 crossover selection) 4.38
P.idA (PID A Menu) 5.3
P.idB (PID B Menu) 5.3
P.idA (PID A lockout) 6.4
P.idB (PID B lockout) 6.4
PLQC (Panel Lockout Menu) 6.1 - 6.6
Pr2 (input 2 process) 3.2, 8.10
PrC1 (process 1) 4.20
PrC2 (process 2) 4.21
PrC3 (process 3) 4.31
PrOc (crossover process value) 4.39
PrOE (protocol type) 4.46, 8.4

Q, R

RA1A (rate, output 1, PID A) 5.12
RA1B (rate, output 1, PID B) 5.12
RA2A (rate, output 2, PID A) 5.15
RA2B (rate, output 2, PID B) 5.15
RAEE (ramp rate) 4.43
RAE (ratio) 4.36
RE1A (reset, output 1, Pid A) 5.11
RE1B (reset, output 1, PID B) 5.11
RE2A (reset, output 2, PID A) 5.14
RE2B (reset, output 2, PID B) 5.14
REU (reverse action) 4.37
rH1 (range high 1) 4.5 - 4.6
rH2 (range high 2) 4.11 - 4.12, 8.11
rL1 (range low 1) 4.5 - 4.6
rL2 (range low 2) 4.11 - 4.12, 8.11
root (square root extraction) 8.14, 8.15
rP (ramping function) 4.43, 8.17
rSP (remote set point) 4.10, 8.8, 8.19
rSE (restore) 6.14
red1 (RTD calibration curve 1) 4.7
red2 (RTD calibration curve 2) 4.14

S

SEE (Setup Menu) 4.1
SHYS (slidewire hysteresis) 4.16
SIL2 (silencing 2) 4.24
SIL3 (silencing 3) 4.27
SIL4 (silencing 4) 4.30
SLid (slidewire) 8.23
Sn (serial number) 6.8
SQFE (software revision) 6.8
SP2 (set point 2) 5.3
SP2c (set point 2 control) 4.22
SEPE (set point) 8.17
SEPE (crossover set point value) 4.39
SErE (start) 8.17
SYS (system lockout) 6.4
SYS (System Menu) 5.2

T, U, V, W, X, Y, Z

TEout (test outputs) 6.11

Menu Overview

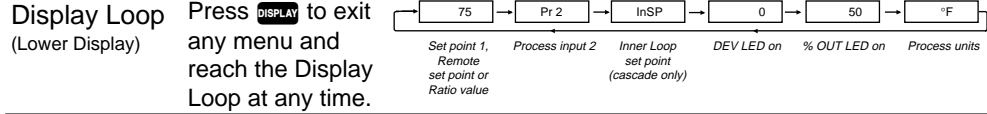

Figure A.10 - The Series 988 Map.

NOTE:
This is a complete listing of all Series 988 prompts.

Not all prompts will appear on your control. They are dependent on your configuration and model number.

To navigate:
Press **DISPLAY** to return to the Display Loop from any location and to advance through the Display Loop.

Press **▲** or **▼** to move between the menus.

Press **MODE** to advance through a menu.

Hold **MODE** while pressing **▲** to move backwards through the menus.

Press **▲** or **▼** to select prompt values.

NOTE:
The controller will not default back to normal display while in the Factory Menu. All outputs are disabled while in this menu.

Operation Menus

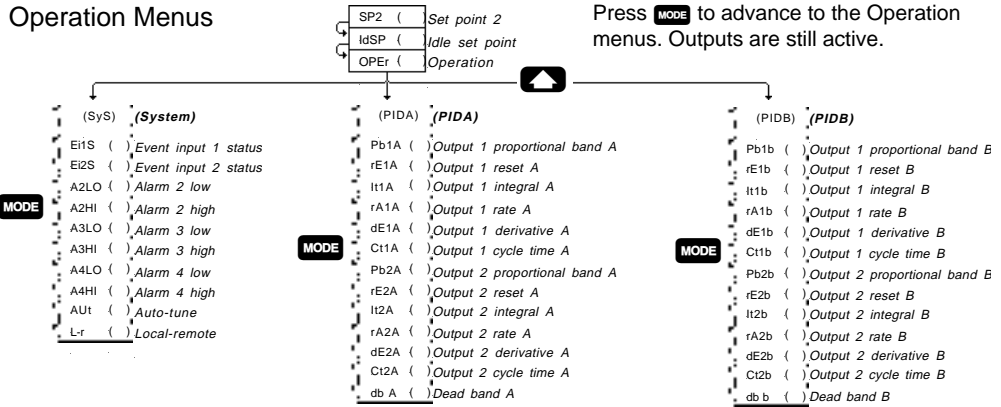

Setup Menus

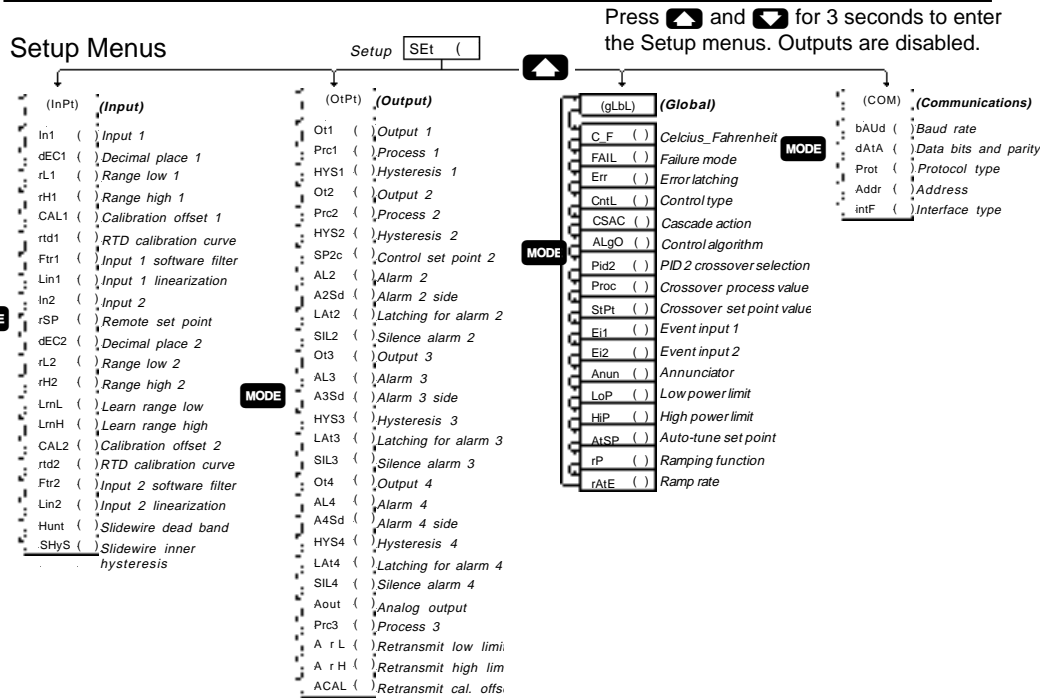

Factory Menus

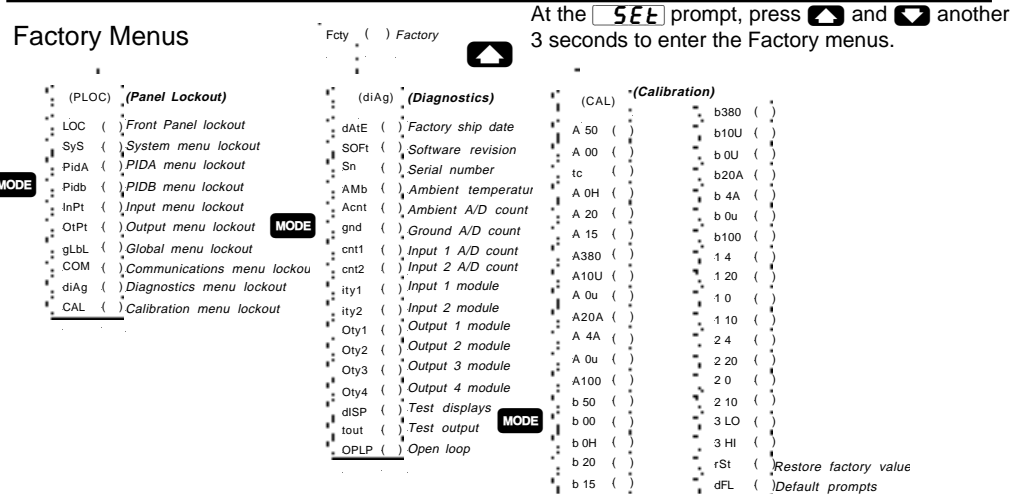

Ordering Information

(1658)

To order, complete the code number to the right with the information below:

9 8 - - - - -

Series 988: a single-channel, temperature/process controller, 1 analog input, 1 digital input, 1 analog or digital input, 4 outputs.

Power Supply & Mounting _____

- 6 = 24 to 28V \approx (ac/dc) nominal, vertical mounting
- 7 = 24 to 28V \approx (ac/dc) nominal, horizontal mounting
- 8 = 100 to 240V \approx (ac/dc) nominal vertical mounting
- 9 = 100 to 240V \approx (ac/dc) nominal horizontal mounting

Software _____

- A = Standard
- B = Enhanced (Includes cascade, ratio, | duplex, dual PID set)

Input 1 _____

- 1 = Thermocouple only (Excluding Type B, R, and S)
- 2 = Universal signal conditioner

Input 2 _____

- 0 = None
- 1 = Thermocouple only (Excluding Type B, R, and S)
- 2 = Universal signal conditioner
- 3 = Slidewire feedback
- 4 = Current transformer²
- 5 = Digital contact event (One digital event is standard on all units)

Output 1 _____

- B = Solid-state relay, Form A, 0.5A, with RC suppression (NO & C)
- C = Switched dc or open collector, isolated
- D = Electromechanical relay¹, Form C, 5A with RC suppression
- E = Electromechanical relay¹, Form C, 5A without contact suppression
- F = Universal process, 0-5V \approx (dc), 1-5V \approx (dc), 0-10V \approx (dc), 0-20mA, 4-20mA, isolated
- K = Solid-state relay, Form A, 0.5A, without contact suppression (NO & C)

Output 2 _____

- A = None
- B = Solid-state relay, Form A, 0.5A, with RC suppression (NO & C)
- C = Switched dc or open collector, isolated
- D = Electromechanical relay¹, Form C, 5A with RC suppression (NO, NC & C)
- E = Electromechanical relay¹, Form C, 5A without contact suppression (NO, NC & C)
- F = Universal process 0-5V \approx (dc), 1-5V \approx (dc), 0-10V \approx (dc), 0-20mA, 4-20mA, isolated
- K = Solid-state relay, Form A, 0.5A, without contact suppression (NO & C)
- T = External signal conditioner power supply, 5, 12 or 20V \approx (dc) @ 30mA

Output 3 _____

- A = None
- B = Solid-state relay, Form A, 0.5A, with RC suppression (NO & C)
- C = Switched dc, isolated
- J = Electromechanical relay¹, Form A or B, 5A without contact suppression (NO or NC)
- K = Solid-state relay, Form A, 0.5A without contact suppression (NO & C)
- M = Retransmit, 0-20mA, 4-20mA
- N = Retransmit, 0-5V \approx (dc), 1-5V \approx (dc), 0-10V \approx (dc)
- T = External signal conditioner power supply, 5, 12 or 20V \approx (dc) @ 30mA

Output 4 _____

- A = None
- B = Solid-state relay, Form A, 0.5A, with RC suppression (NO & C)
- C = Switched dc or open collector, isolated
- D = Electromechanical relay¹, Form C, 5A with RC suppression (NO, NC & C)
- E = Electromechanical relay¹, Form C, 5A without contact suppression (NO, NC & C)
- K = Solid-state relay, Form A, 0.5A without contact suppression (NO & C)
- R = EIA/TIA-232 communications, opto-isolated
- S = EIA/TIA-485 / EIA/TIA-422 communications, opto-isolated
- T = External signal conditioner power supply, 5, 12 or 20V \approx (dc) @ 30mA
- U = EIA/TIA-485 / EIA/TIA-232 communications, opto-isolated

Display _____

- GG = Green/Green displays
- GR = Green/Red displays
- RG = Red/Green displays
- RR = Red/Red displays
- XX = Custom overlays or default settings

¹Electromechanical relays warranted for 100,000 closures only. Solid-state switching devices recommended for applications requiring fast cycle times or extended service life.

²A Current Transformer input cannot be used in conjunction with a process output installed on output 1.

Slo-Blo® is a registered trademark of Littelfuse, Inc.

User documentation may be available in French, German, Spanish, Italian and Dutch, as well as English. Check Watlow's web site (www.watlow.com/) for availability. Specify language and quantity at time of order.

Declaration of Conformity

Series 986, 987, 988, 989



WATLOW CONTROLS

1241 Bundy Boulevard

Winona, Minnesota 55987 USA

Declares that the following product:

English

Designation: Series 986, 987, 988, 989
 Model Number(s): 9 8 (6, 7, 8 or 9) (Any letter) - (1 or 2) (0 1 2 3 4 or 5) (B C D E F or K) (A B C D E F K or T) - (A B C J K M N or T) (A B C D E K R S or T) (Any two letters)
 Classification: Control, Installation Category II, Pollution Degree II
 Rated Voltage: 100 to 240V~ (ac) or 24 to 28V≈ (ac/dc)
 Rated Frequency: 50/60 Hz
 Rated Power Consumption: 16VA maximum

Meets the essential requirements of the following European Union Directive(s) using the relevant section(s) of the normalized standards and related documents shown:

89/336/EEC Electromagnetic Compatibility Directive

- EN 50082-2: 1995 EMC Generic immunity standard, Part 2: Industrial environment**
- EN 61000-4-2: 1995 Electrostatic discharge
 - EN 61000-4-4: 1995 Electrical fast transients
 - ENV 50140: 1994 Radiated immunity
 - ENV 50141: 1994 Conducted immunity
 - ENV 50204: 1995 Cellular phone
- EN 50081-2: 1994 EMC Generic emission standard, Part 2: Industrial environment**
- EN 55011: 1991 Limits and methods of measurement of radio disturbance characteristics of industrial, scientific and medical radio-frequency equipment (Class A)
 - EN 61000-3-2: 1995 Limits for harmonic current emissions
 - EN 61000-3-3: 1995 Limitations of voltage fluctuations and flicker

73/23/EEC Low-Voltage Directive

- EN 61010-1: 1993 Safety requirements for electrical equipment for measurement, control, and laboratory use, Part 1: General requirements**

Déclare que le produit suivant :

Français

Désignation : Série 986, 987, 988, 989
 Numéro(s) de modèle(s) : 98 (6, 7, 8 ou 9) (lettre quelconque) - (1 ou 2) (0, 1, 2, 3, 4 ou 5) (B, C, D, E, F ou K) (A, B, C, D, E, F, K ou T) - (A, B, C, J, K, M, N ou T) (A, B, C, D, E, K, R, S, ou T) (deux lettres quelconques)
 Classification : Commande, installation catégorie II, degré de pollution II
 Tension nominale : 100 à 240 V ~ ou 24 à 28 V ≈ (c.a./c.c.)
 Fréquence nominale : 50/60 Hz
 Consommation d'alimentation nominale : 16 VA maximum

Conforme aux exigences de la (ou des) directive(s) suivantes de l'Union Européenne figurant aux sections correspondantes des normes et documents associés ci-dessous :

89/336/EEC Directive de compatibilité électromagnétique

- EN 50082-2 : 1995 Norme générique d'insensibilité électromagnétique, Partie 2 : Environnement industriel**
- EN 61000-4-2 : 1995 Décharge électrostatique
 - EN 61000-4-4 : 1995 Courants électriques transitoires rapides
 - ENV 50140 : 1994 Insensibilité à l'énergie rayonnée
 - ENV 50141 : 1994 Insensibilité à l'énergie par conduction
 - ENV 50204 : 1995 Téléphone cellulaire
- EN 50081-2 : 1994 Norme générique sur les émissions électromagnétiques, Partie 2 : Environnement industriel**
- EN 55011 : 1991 Limites et méthodes de mesure des caractéristiques d'interférences du matériel radiofréquence industriel, scientifique et médical (Classe A)
 - EN 61000-3-2 : 1995 Limites d'émission d'harmoniques
 - EN 61000-3-3 : 1995 Limitations d'écart de tension et de papillotement

73/23/EEC Directive liée aux basses tensions

- EN 61010-1 : 1993 Exigences de sécurité pour le matériel électrique de mesure, commande et de laboratoire, Partie 1 : Exigences générales**

Erklärt, daß das folgende Produkt:

Deutsch

Beschreibung: Serie 986, 987, 988, 989
 Modellnummer(n): 9 8 (6 7 8 oder 9) (beliebiger Buchstabe) - (1 oder 2) (0 1 2 3 4 oder 5) (B C D E F oder K) (A B C D E F K oder T) - (A B C J K M N oder T) (A B C D E K R S oder T) (2 beliebige Buchstaben)
 Klassifikation: Regelsystem, Installationskategorie II, Emissionsgrad II
 Nennspannung: 100 bis 240 V~ (ac) oder 24 bis 28 V≈ (ac/dc)
 Nennfrequenz: 50/60 Hz
 Stromverbrauch: Max. 16 VA

Erfüllt die wichtigsten Normen der folgenden Anweisung(en) der Europäischen Union unter Verwendung der untenstehenden einschlägigen Dokumente:

89/336/EEC Elektromagnetische Übereinstimmungsanweisung

- EN 50082-2: 1995 EMC-Rahmennorm für Störsicherheit, Teil 2: Industrielle Umwelt**
- EN 61000-4-2: 1995 Elektrostatische Entladung
 - EN 61000-4-4: 1995 Elektrische schnelle Stöße
 - ENV 50140: 1994 Strahlungsimmunität
 - ENV 50141: 1994 Leitungsimmunität
 - ENV 50204: 1995 Mobiltelefon
- EN 50081-2: 1994 EMC-Rahmennorm für Emissionen, Teil 2: Industrielle Umwelt**
- EN 55011: 1991 Beschränkungen und Methoden der Messung von Funkstörungsmerkmalen industrieller, wissenschaftlicher und medizinischer Hochfrequenzgeräte (Klasse A)
 - EN 61000-3-2: 1995 Grenzen der Oberwellenstromemissionen
 - EN 61000-3-3: 1995 Grenzen der Spannungsschwankungen und Flimmern
- 73/23/EEC Niederspannungsrichtlinie zu entsprechen**
- EN 61010-1: 1993 Sicherheitsrichtlinien für Elektrogeräte zur Messung, zur Steuerung und im Labor, Teil 1: Allgemeine Richtlinien**

Declara que el producto siguiente:

Español

Designación: Series 986, 987, 988, 989
 Números de modelo: 9 8 (6 7 8 ó 9)(Cualquier letra) - (1 ó 2)(0 1 2 3 4 ó 5)(B C D E F o K)(A B C D E F K o T) - (A B C J K M N o T)(A B C D E K R S o T)(Cualquier combinación de dos letras)
 Clasificación: Control, categoría de instalación II, grado de contaminación ambiental II
 Tensión nominal: 100 a 240 V~ (Vca) o 24 a 28 V ≈ (Vca/Vcc)
 Frecuencia nominal: 50/60 Hz
 Consumo nominal de energía: 16 VA máximo

Cumple con los requisitos esenciales de las siguientes directivas de la Unión Europea, usando las secciones pertinentes de las reglas normalizadas y los documentos relacionados que se muestran:

89/336/EEC - Directiva de compatibilidad electromagnética

- EN 50082-2: 1995 Norma de inmunidad genérica del EMC, parte 2: Ambiente industrial**
- EN 61000-4-2: 1995 Descarga electrostática
 - EN 61000-4-4: 1995 Perturbaciones transitorias eléctricas rápidas
 - ENV 50140: 1994 Inmunidad radiada
 - ENV 50141: 1994 Inmunidad conducida
 - ENV 50204: 1995 Teléfono portátil
- EN 50081-2: 1994 Norma de emisión genérica del EMC, parte 2: Ambiente industrial**
- EN 55011: 1991 Límites y métodos de medición de características de perturbaciones de radio correspondientes a equipos de radiofrecuencia industriales, científicos y médicos (Clase A)
 - EN 61000-3-2: 1995 Límites para emisiones de corriente armónica
 - EN 61000-3-3: 1995 Limitaciones de fluctuaciones del voltaje
- 73/23/EEC Directiva de baja tensión**
- EN 61010-1: 1993 Requerimientos de seguridad para equipos eléctricos de medición, control y uso en laboratorios, Parte 1: Requerimientos generales**

Erwin D. Lowell Winona, Minnesota, USA
 Name of Authorized Representative Place of Issue

General Manager January 9, 1996
 Title of Authorized Representative Date of Issue

 Signature of Authorized Representative

Watlow Series 988 User's Manual

Watlow Controls, 1241 Bundy Blvd., P.O. Box 5580, Winona, MN 55987-5580, Phone: 507/454-5300, Fax: 507/452-4507