

Series 35

Installation

Temperature Control with 1, 2 or 3 Pole Mercury Relay Output

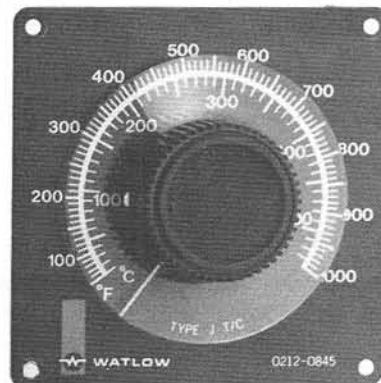
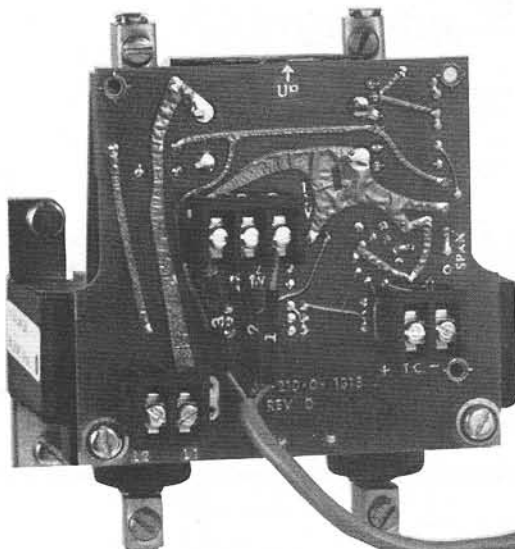

Optional NEMA 1 Enclosure

Specifications

- **Control Mode:**
Time Proportioning or ON-OFF (3°F Switching Differential)
- **Input:** Thermocouple, Grounded or Ungrounded
Type "J" T/C, 50-500°F/10-260°C
Type "J" T/C, 50-1000°F/10-538°C
Type "K" T/C, 100-2000°F/50-1050°C
- **Display:** Calibrated dial scale
Integral Assy. with °F/°C Scale
Remote Assy. with °F/°C Scale
- **Output:** Normally Open contacts rated at 25, 35, or 60 Amps, up to 480VAC with a 1, 2 or 3 Pole Mercury Relay
- **Output Connections:**
35 & 65A Relay: Heavy Duty Compression Type
25A Relay: Binding Head Screw Type
- **Control Connection:**
¼" Quick Connects or Barrier Strip, #3-48 Screw Clamp
- **Control Line Voltage:**
24VAC, 115VAC, or 230VAC
50-60Hz ± 10%
- **T/C Compensation:** Automatic
- **T/C Break Protection:**
Load Shut-Off w/Open T/C
- **Isolation:** Sensor and Control isolated from Line and Load.
- **Set Point Stability:**
± 10 V/°F Typical, Referred to the Input.
- **Operating Environment:**
30° to 130°F, 0° to 55°C
10 to 100% RH, Non-condensing
- **Unit Mount:** Mount Vertically ± 30°
- **Optional Enclosure:**
NEMA/1 in 2 sizes:
Small for Series 35 with 1 or 2 pole relay output.
Large for Series 35 with 3 pole relay output.
- **UL Pending, File # E43684**



WATLOW

1241 Bundy Blvd.

Winona, Minnesota 55987

(507) 454-5300

Remote Set Pot Mounting Dimensions

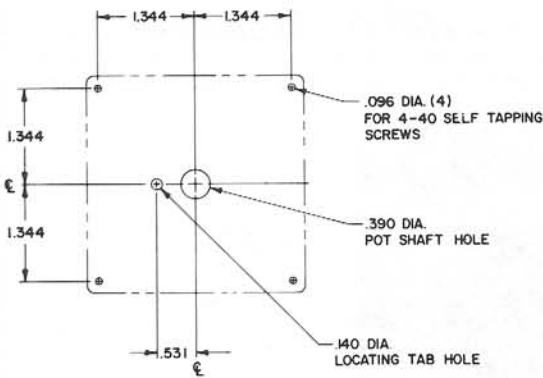

Model Number Information

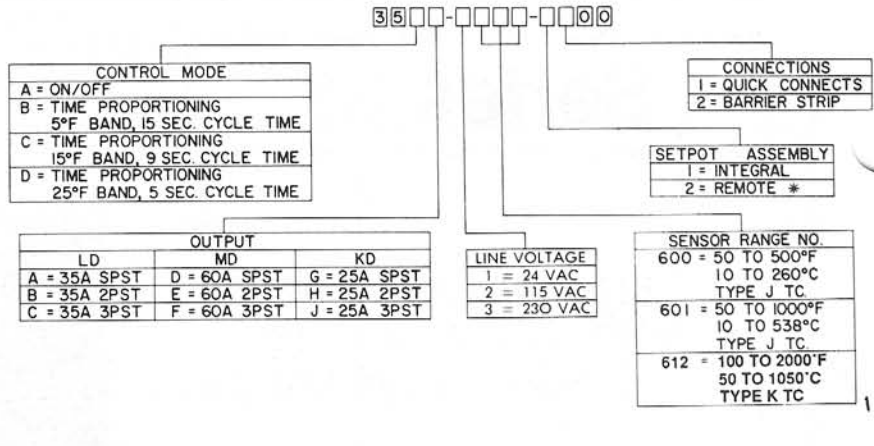

Mounting

Control with Relay

- Look at the 4th digit of the model number on your unit. Compare the 4th digit with the Model Number Information chart here. Then find the correct mounting diagram at the right to mount your unit. Notice that the mounting diagrams on this page combine details of the similar 35 Amp (LD) and 60 Amp (MD) relays. Diagrams on the back page of this literature show mounting for 25 Amp (KD) Series 35's.
- Mark and drill the 0.188 inch mounting holes for your Series 35.

Note: On 35 and 60 Amp Series 35's, maintain 0.50 inch clearance from the lower relay contact to the bottom of an enclosure. On 25 Amp relay Series 35's, maintain 0.50 inch clearance from the centerline of the lower mounting holes to the bottom of an enclosure.
- Mount the Series 35 with 10-32 screws.
- Wire your unit according to the wiring diagram adjacent to the mounting diagram.

Remote Set Pot

- Refer to the Remote Set Pot Mounting Dimensions diagram.
- Drill a 0.390" diameter hole for the set pot shaft.
- Drill a 0.140" tab hole to the left of the shaft hole according to the diagram.
- Drill four 0.96" holes for the corners of the dial scale using the diagram dimensions.
- Loosen the two set screws on the set pot knob and remove the control knob with its clear plastic shield. Remove the nut and washer from the set pot shaft.
- Insert the set pot shaft through its hole from the rear placing the aligning tab in its hole.
- Place the dial scale on the set pot shaft and anchor it with four 4-40 self-tapping screws.
- Secure the pot shaft with the washer and dial scale nut.
- Turn the pot shaft to the maximum counter clockwise position. Place the knob on the shaft.
- Align the indicator mark on the clear plastic shield with the mechanical zero marker on the dial scale. Tighten the two control knob set screws.

Mounting

NOTE: Control mounting is identical for both integral and remote set pot versions.

1 Pole

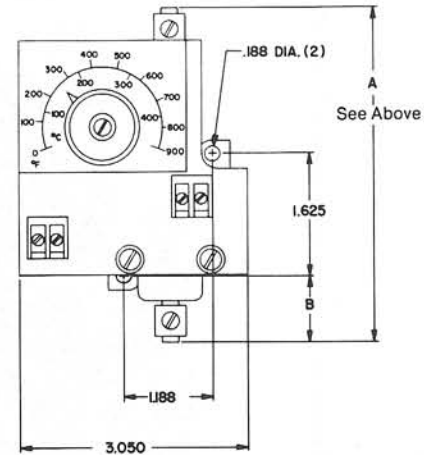

2 Pole

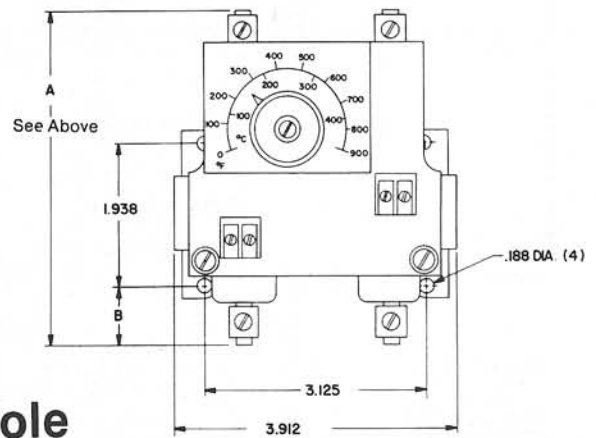

3 Pole

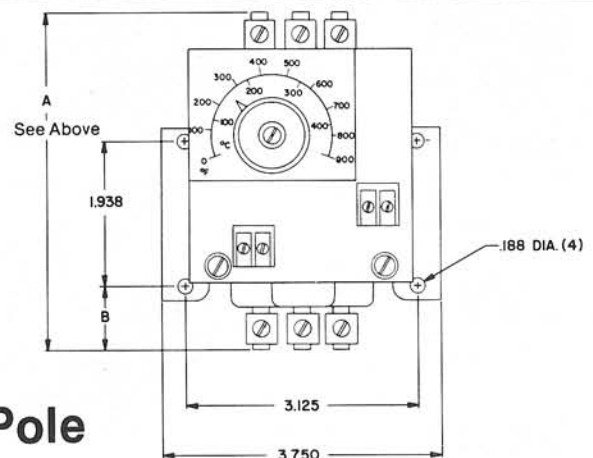

35 / 60 Amp Relay Dimensions

Series 35 35 / 60 Amp Outputs

35□□-□□□□-□□□□

	A	B	C	D	E	F
A DIM.	4.55			5.00		
B DIM.	.90	.744	.750	1.07	.911	.917

NOTE: All dimensions in inches.

NOTE SETPOT FOR RANGE CONNECTIONS	
QUICK CONNECT	BARRIER STRIP
A006-0428	A006-0430
A006-0429	A006-0431
A006-0452	N/A

Wiring

NOTE: Thermocouple, Relay Terminal and Line Voltage wiring are identical for both integral and remote set pot units. On remote set pot units wire the set pot according to the diagram.

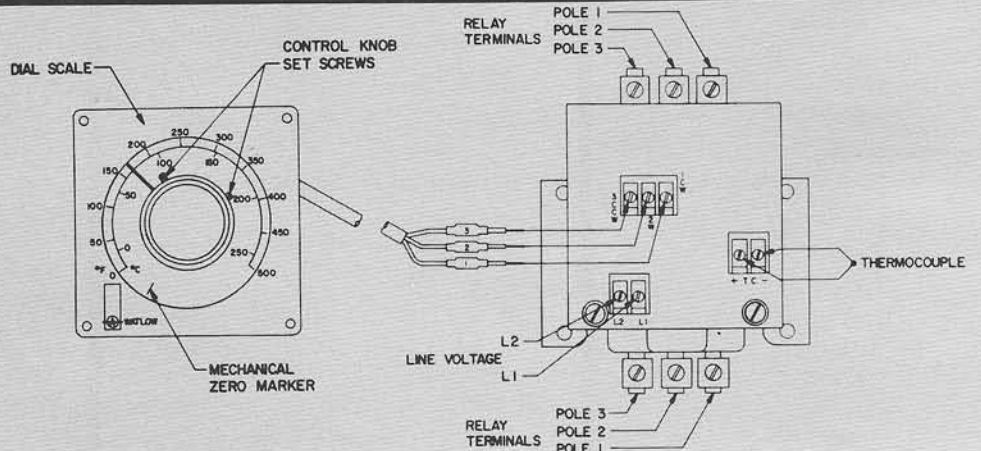
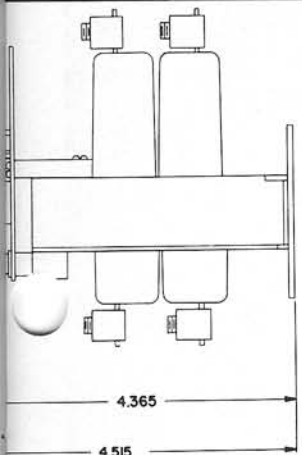
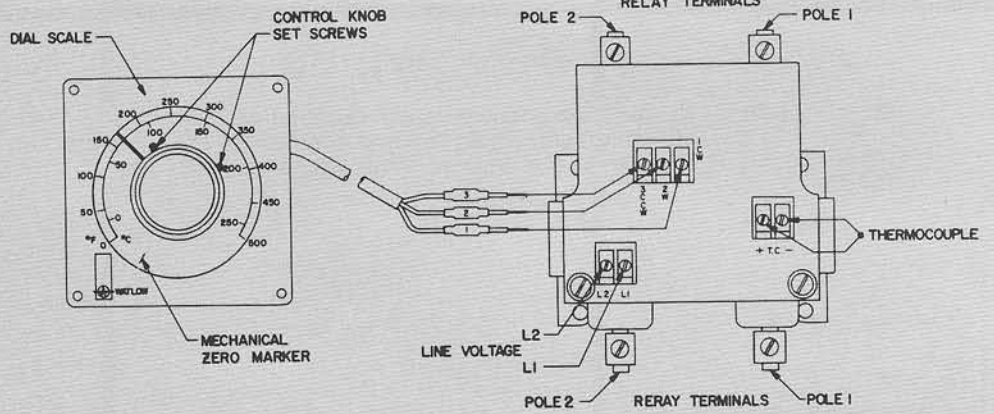
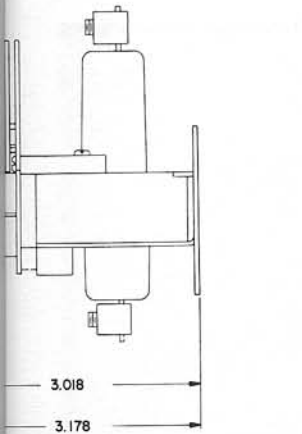
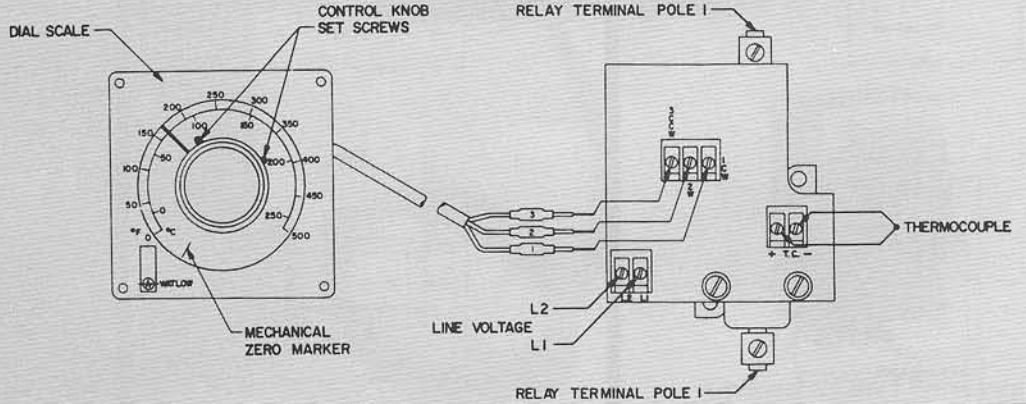
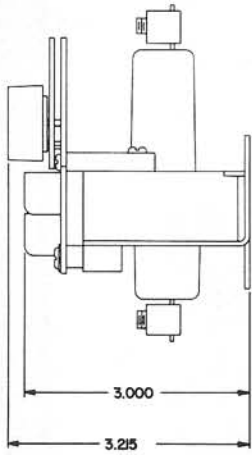

Series 35 - 25 Amp Output

Mounting

NOTE: Control mounting is identical for both integral and remote set pot versions.

1 Pole

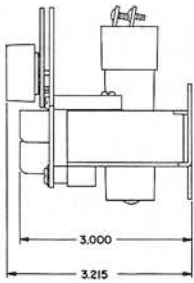
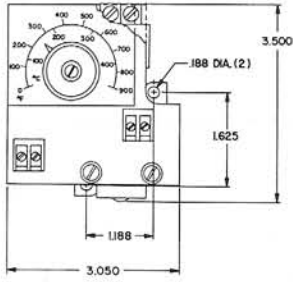

2 Pole

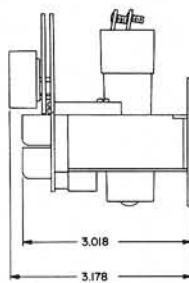
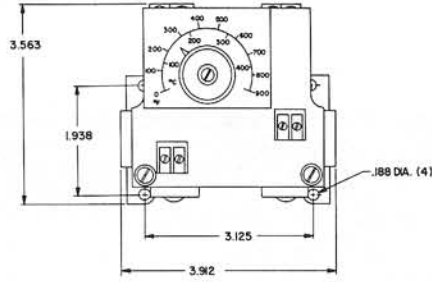

3 Pole

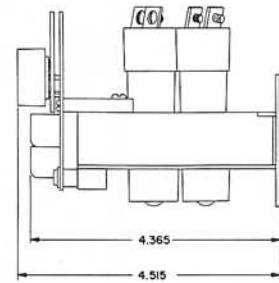
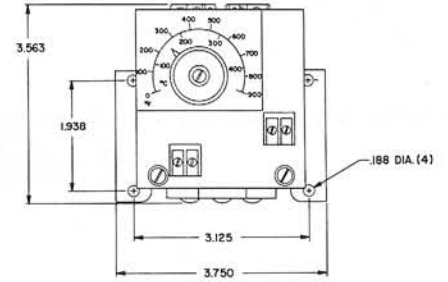

Wiring

NOTE: Thermocouple, Relay Terminal and Line Voltage wiring are identical for both integral and remote set pot units. On remote set pot units wire the set pot according to the diagram.

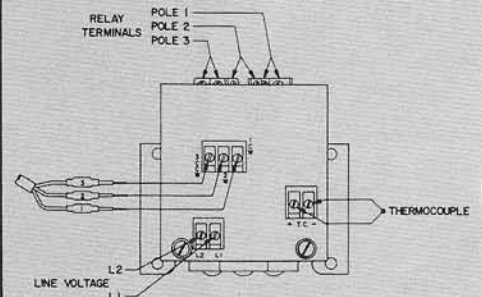
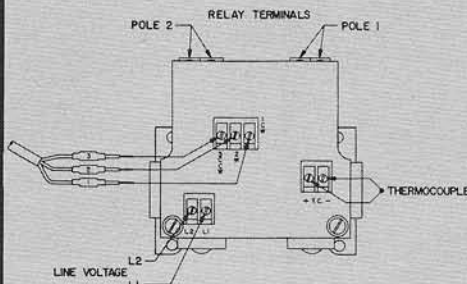
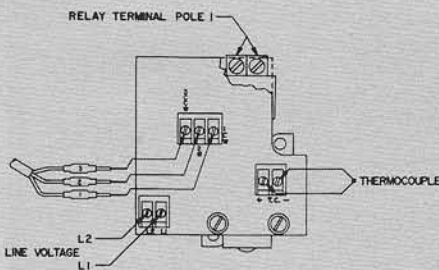
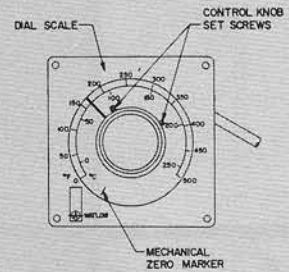
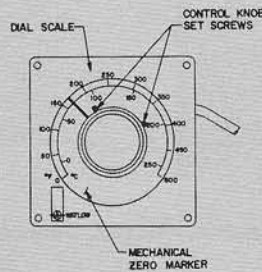
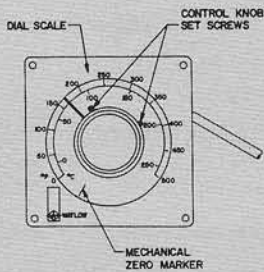

Now Watlow Offers You the “Advantage”...

A Unique Combination of a Low Cost, High Capability Temperature Control and a Power Switching Module

We call our new Series 35 switching control module the “Advantage” because it gives you what you’ve never had before in low cost, temperature control . . . a high performance thermocouple temperature control and a reliable mercury relay combined in a single, inexpensive, simple to use package.

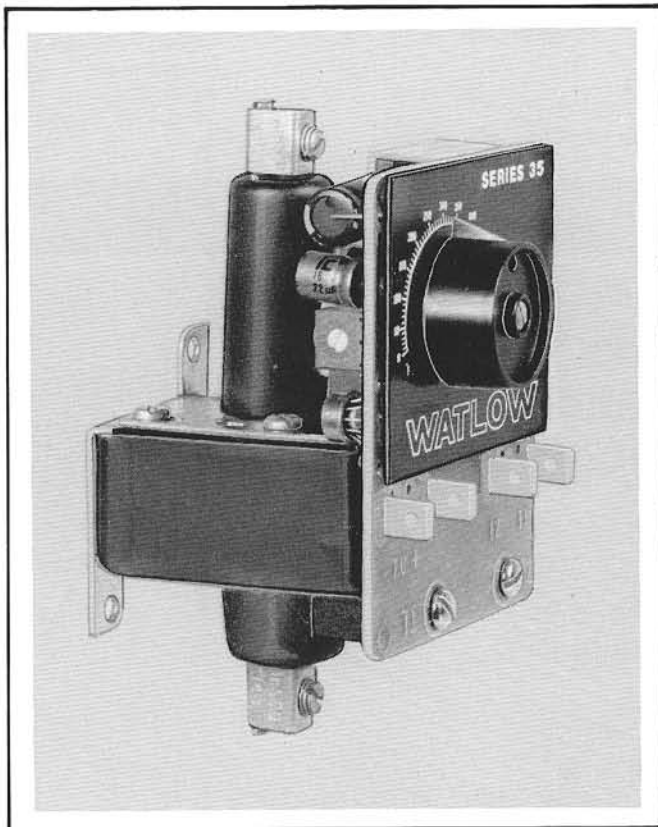

You Can Enjoy the “Advantages” of:

- Thermocouple sensor included
- Precise control to adjustable set point
- High ampere switching (35 & 60 amp)
- Solid state electronics
- Exceptional reliability
- Hermetically-sealed switch
- Extended, trouble-free life
- 1, 2 & 3 pole models
- Wider temperature ranges
- Ease of installation
- Quiet operation
- Off-the-shelf availability
- Available metal enclosure
- Many OEM options

MODEL 35AA-2600-1100
SINGLE POLE AS SHOWN
\$96.00 LIST

Specifications

CONTROL MODE:

On-off

OUTPUT:

Normally open contact rated at 35 or 60 amps, 1, 2 or 3 pole.

INPUT:

"J" Thermocouple with 30" leads and a 6" long 1/8" diameter sheath, included as standard.

LINE VOLTAGE:

All ± 10% 47 to 63 Hz.

- 1. 24VAC
- 2. 115VAC
- 3. 230VAC

OPERATING AMBIENT:

Temperature 30° to 150°F/0° to 66°C
Humidity 10% to 100% non-condensing.

OPEN SENSOR PROTECTION:

Load will shut-off in the event of an open sensor.

THERMOCOUPLE COMPENSATION:

Automatic.

ENCLOSURE:

Optional.

LOAD CONNECTIONS:

Heavy duty compression terminals.

SET POT:

- 1. Integral mount assembly with F/C dial scale—Standard.
- 2. Remote mount assembly with F/C dial scale—Optional.

MOUNTING:

The unit must be mounted vertical ± 30°.

ISOLATION:

Sensor and control circuitry isolated from line and load.

How To Order

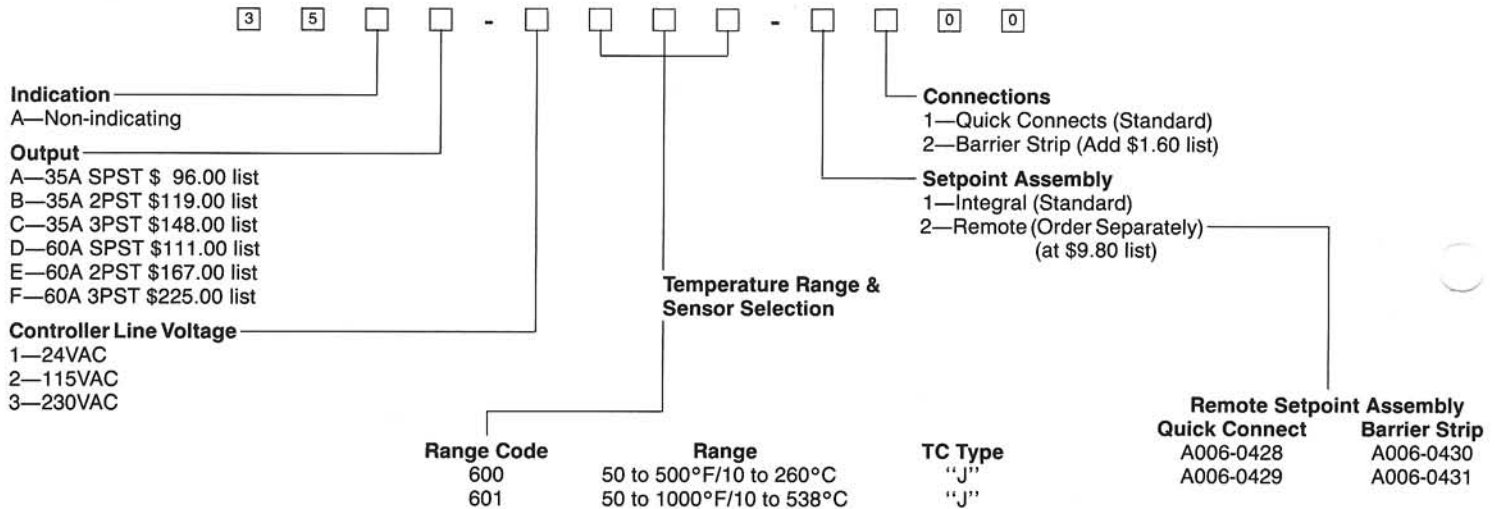

**It's Your Turn to Have the "Advantage."
Call us today for assistance with your heat,
sensing and control electronics needs.**

