

Oregon SCIENTIFIC

Wireless Weather Station with Temperature / Humidity Display and Self-Setting Atomic Clock Model: BAR388HGA

USER MANUAL

INTRODUCTION

Thank you for selecting this Oregon Scientific™ Wireless Weather Station with Temperature / Humidity Display and Self-Setting Atomic Clock (BAR388HGA). This clock is supplied with a remote sensor (THGR122N) and can support up to 3 sensors in total (additional sensors sold separately).

NOTE Please keep this manual handy as you use your new product. It contains practical step-by-step instructions, as well as technical specifications and warnings you should know about.

CLOCK OVERVIEW

FRONT VIEW



1. SNOOZE
2. Weather Forecast Area
3. Outdoor Temperature Area
4. Indoor Temperature Area
5. Clock / Alarm Area
6. ALARM: View alarm status; set alarm

BACK VIEW

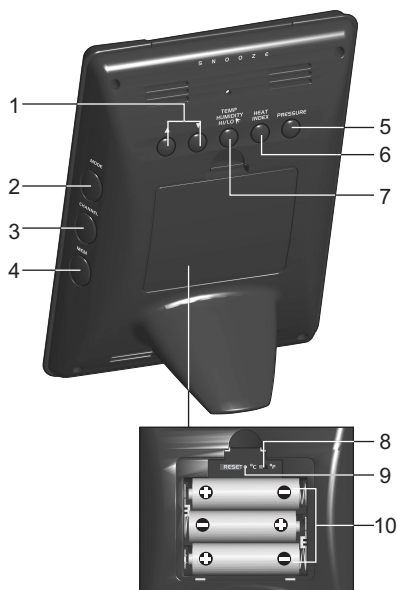

1. ▲ / ▼ : Increase / decrease setting; activate / deactivate clock reception signal
2. **MODE**: Change settings / display
3. **CHANNEL**: Switch remote sensor display
4. **MEM**: View current, maximum and minimum temperature / humidity
5. **PRESSURE**: Select pressure unit; set altitude
6. **HEAT INDEX**: Display heat index
7. **TEMP / HUMIDITY HI / LO** : Change settings or enable / disable hi or lo temperature / humidity alarm for channel 1
8. °C / °F: Select temperature unit
9. **RESET**: Reset unit to default settings
10. Battery compartment

LCD DISPLAY

Weather Forecast Area:

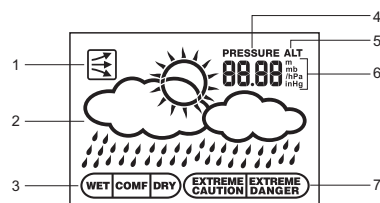

1. Pressure trend
2. Weather forecast
3. Comfort zone
4. Pressure icon
5. Altitude icon
6. Pressure / altitude unit
7. Heat index icon

Outdoor Temperature Area:

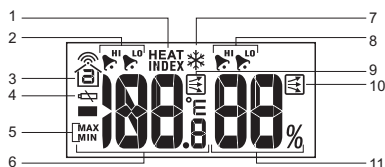

1. Heat index icon
2. Hi / lo temperature alarm
3. Sensor reception icon
4. Sensor battery low
5. Max / min icon
6. Temperature display
7. Ice warning is active
8. Hi / lo humidity alarm
9. Temperature trend
10. Humidity trend
11. Humidity display

Indoor Temperature Area:

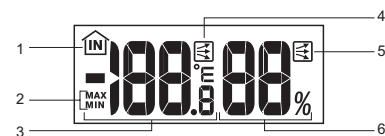

1. Indoor sensor icon
2. Max / min icon
3. Temperature display
4. Temperature trend
5. Humidity trend
6. Humidity display

Clock / Alarm Area:

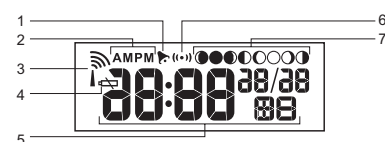

1. Alarm set
2. AM / PM icon
3. Clock signal reception
4. Low battery icon
5. Clock
6. Alarm mode icon
7. Moon phase

REMOTE SENSOR (THGR122N)

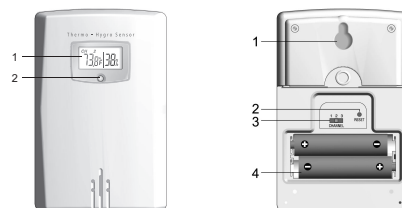

1. LCD
2. LED status indicator: Blinks red during data transmission
1. Wall mount hole
2. **RESET** hole
3. **CHANNEL** switch
4. Battery compartment

GETTING STARTED

BATTERIES

Insert batteries before first use, matching the polarity (+ and -). Press **RESET** after each battery change.

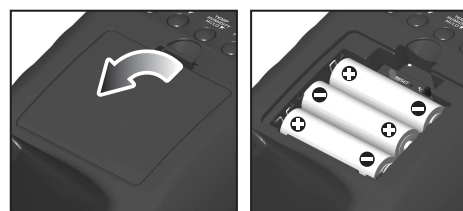

indicates main unit batteries are low.

NOTE Do not use rechargeable batteries. We recommend that you use alkaline batteries with this product for longer usage and lithium batteries in temperatures below freezing.

REMOTE SENSOR

The sensor collects temperature readings approx. every 40 seconds and sends them to the main unit. The main unit can collect data from up to 3 sensors.

To set up the sensor:

1. Remove the screws from the battery door.
2. Insert the batteries, matching the polarity (+ / -).

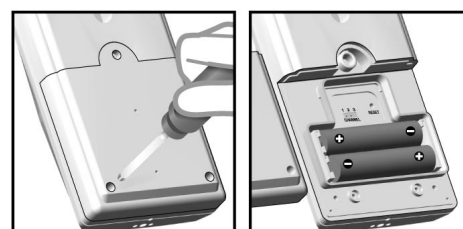

3. Select a channel. Make sure you use a different channel for each sensor.
4. Place the sensor near the main unit. Press **RESET** on the sensor.
5. Simultaneously press **CHANNEL** and **MEM** on the main unit to initiate signal sending between the sensor and main unit.
6. Close the battery door and secure the screws.
7. Place the sensor in the desired location using the table stand or wall mount.

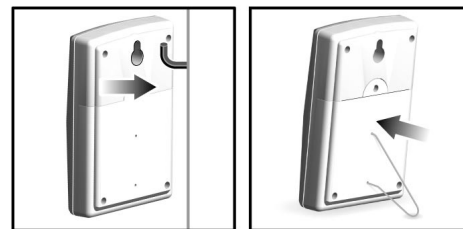

For best results:

- Place the sensor out of direct sunlight and moisture.
- Do not place the sensor more than 30 m (100 ft) from the main (indoor) unit.
- Position the sensor so that it faces the main (indoor) unit, minimizing obstructions such as doors, walls, and furniture.
- Place the sensor in a location with a clear view to the sky, away from metallic or electronic objects.
- Position the sensor close to the main unit during cold winter months as below-freezing temperatures may affect battery performance and signal transmission.

The transmission range may vary depending on many factors. You may need to experiment with various locations to get the best results.

Standard Alkaline batteries contain significant amounts of water. Because of this they will freeze in low temperatures of approximately -12°C (10°F). Disposable Lithium batteries have a much lower threshold for temperature with an estimated freezing range of below -30°C (-22°F).

Wireless ranges can be impacted by a variety of factors such as extremely cold temperatures. Extreme cold may temporarily reduce the effective range between the sensor and the base station. If the unit's performance fails due to low temperature, the unit will resume proper functioning as the temperature rises to within the normal temperature range (i.e. no permanent damage will occur to the unit due to low temperatures).

SENSOR DATA TRANSMISSION

The sensor reception icon in the remote sensor area shows the status.

ICON	DESCRIPTION
	Main unit is searching for the sensor(s)
	A channel has been found and sensor signal is being received
	The sensor cannot be found. Search for the sensor or check batteries

To search for a sensor:

Simultaneously, press and hold **MEM** and **CHANNEL** for 2 seconds.

NOTE If the sensor is still not found, check the batteries, obstructions, and remote unit location.

CLOCK

CLOCK RECEPTION

This product is designed to synchronize its date and time automatically once it is within range of the WWVB-60 signal from the atomic clock in Fort Collins, Colorado.

The clock collects the radio signals whenever it is within 3219 km (2000 miles) of a signal.

NOTE Initial reception takes 2-10 minutes for first set up or when **RESET** is pressed. Once complete, the reception icon will stop blinking. If the signal is weak, it can take up to 24 hours to get a valid signal.

RECEPTION SIGNAL

Clock signal reception indicator:

STRONG SIGNAL	WEAK SIGNAL	NO SIGNAL

To enable and force a signal search:
Press and hold ▲ for 2 seconds.

To disable the signal reception:
Press and hold ▼ for 2 seconds.

SET CLOCK

If the clock signal reception is enabled and a signal is being received the clock does not need to be manually set.

1. Press and hold **MODE** for 2 seconds.
2. Press ▲ or ▼ to change the settings.
3. Press **MODE** to confirm.
4. The settings order is: US time zone (Pacific (P), Eastern (E), Central (C) and Mountain (M)) offset, hour, minute, year, month, day and language.

NOTE The language options are English (E), German (D), French (F), Italian (I), and Spanish (S).

Press **MODE** to choose between the clock with seconds and clock with weekday display modes.

ALARM

To set the alarm:

1. Press and hold **ALARM** for 2 seconds.
2. Press **▲** / **▼** to set hour / minute.
3. Press **ALARM** to confirm. **▶** indicates alarm is ON.

To enable / disable the alarm:

1. Press **ALARM** to display alarm time.
2. Press **ALARM** again to turn alarm ON / OFF.

To silence the alarm:

- Press **SNOOZE** to silence it for 8 minutes.
- OR
- Press any key except **SNOOZE** to turn the alarm off and activate it again after 24 hours.

BAROMETER

Barometer readings from the past 24 hours are stored by the main unit and used to provide weather forecast.

To select barometer measurement unit:

Press **PRESSURE** to toggle between mb and inHg.

SET ALTITUDE





To ensure barometric readings are reliable set the altitude to reflect distance from sea level at your position.

1. Press and hold **PRESSURE** for 2 seconds.
2. Use **▲** and **▼** to set the altitude in 10 m (33 ft) increments from -100 m (-328 ft) to 2500 m (8202 ft).
3. Press **PRESSURE** to confirm.

NOTE The maximum operating altitude for the barometer and weather forecast is 2500m (8202 ft).

WEATHER FORECAST

This product forecasts the next 12 to 24 hours of weather within a 30-50 km (19-31 mile) radius based on barometric pressure trend readings.

ICON	DESCRIPTION
	Clear
	Partially Cloudy
	Cloudy
	Rainy

TEMPERATURE AND HUMIDITY

To toggle temperature unit:
Press **°C** / **°F**.

To view outdoor sensors temperature readings:
Press **CHANNEL**.

To auto-scan between sensors:
Press and hold **CHANNEL** for 2 seconds.
Each sensor's data is displayed for 3 seconds.



To end auto-scan:
Press **CHANNEL** or **MEM**.

To toggle between current, minimum and maximum records for the selected sensor:
Press **MEM** repeatedly.

To clear the records:
Press and hold **MEM** for 2 seconds.

TEMPERATURE, HUMIDITY AND PRESSURE TREND

The temperature, humidity and pressure trend icons are based on recent sensor readings.

RISING	STEADY	FALLING
		

ICE WARNING

If the channel 1 sensor falls between 3°C to -2°C (37°F to 28°F), ***** flashes to warn you that the temperature is approaching freezing.

NOTE The warning will automatically stop if the temperature goes outside the ice-warning range.

HI / LO TEMPERATURE / HUMIDITY ALARMS

Temperature and humidity alerts can be set to sound if sensor set to channel 1 records above or below a temperature/humidity of your choice.

To set alarm ON / OFF:

1. Press and hold **TEMP / HUMIDITY HI / LO**.
2. Use **▲** and **▼** to select high / low temperature / humidity alarm. Press **TEMP / HUMIDITY HI / LO** to confirm.
3. Press **▲** / **▼** to set alarm **ON** / **OFF** and press **TEMP / HUMIDITY HI / LO** to confirm.
4. If alarm has been activated, use **▲** and **▼** to select the temperature / humidity.
5. Press **TEMP / HUMIDITY HI / LO** to confirm.

To silence the hi / lo alarm:

Press any key. The alarm resets automatically and will resound if the hi / lo temperature is recorded again.

HEAT INDEX

The heat index combines temperature and humidity data to describe the actual temperature felt.



WARNING	HEAT INDEX	MEANING
Extreme danger	54.5°C / (130°F) or above	Strong risk of dehydration / sun stroke
Danger	40.5 - 54°C (105 - 129°F)	Heat exhaustion likely
Extreme caution	32.2 - 40°C (90 - 104°F)	Possibility of heat dehydration
Caution	26.6 - 31.7°C (80 - 89°F)	Possibility of heat exhaustion

- To display the heat index, press **HEAT INDEX**.
- To toggle between current / maximum / minimum readings, press **HEAT INDEX**, then press **CHANNEL** to select channel 1-3 or indoor, followed by **MEM**.
- To toggle between temperature / humidity and heat index display, press and hold **HEAT INDEX** for 2 seconds. Press **HEAT INDEX** again to stop this feature.

NOTE If the heat index is below 80°F / 26°C, or the desired channel is not working, the heat index will display NA.









COMFORT ZONE

The comfort zone assesses the climate based on current temperature and humidity measurements.

ICON	TEMPERATURE	HUMIDITY
	Any	> 70%
	20 - 25°C (68 - 77°F)	40 - 70%
	Any	< 40%

MOON PHASE

- When calendar is set press **▲** or **▼** to view the moon phase for the next / previous day.
- Press and hold **▲** or **▼** to scan through the years (2001 to 2099).

	New Moon
	Waxing Crescent
	First Quarter
	Waxing Gibbous
	Full Moon
	Waning Gibbous
	Last Quarter
	Waning Crescent

RESET

Press **RESET** to return the unit to the default settings.

PRECAUTIONS

This product is engineered to give you years of satisfactory service if you handle it carefully. Here are a few precautions:

- Do not subject the unit to excessive force, shock, dust, temperature or humidity, which may result in malfunction, shorter electronic life span, damaged battery and distorted parts.
- Do not immerse the unit in water. If you spill liquid over it, dry it immediately with a soft, lint-free cloth.

- Do not clean the unit with abrasive or corrosive materials.
- Do not tamper with the unit's internal components. Doing so will invalidate the warranty on the unit and may cause unnecessary damage. The unit contains no user-serviceable parts.
- Only use fresh batteries as specified in the user's instructions. Do not mix new and old batteries.
- Due to printing limitations, the displays shown in this manual may differ from the actual display.
- The contents of this manual may not be reproduced without the permission of the manufacturer.
- Do not dispose this product as unsorted municipal waste. Collection of such waste separately for special treatment is necessary.

NOTE The technical specifications for this product and the contents of the user manual are subject to change without notice.

SPECIFICATIONS

TYPE	DESCRIPTION
MAIN UNIT	
L x W x H	119 x 77 x 169 mm (4.7 x 3.0 x 6.7 in)
Weight	249 g (8.8 oz) without battery
Temperature unit	°C / °F
Temperature range	-5°C to 50°C (23°F to 122°F)
Resolution	0.1°C (0.2°F)
Clock frequency	WWVB-60
Synchronization	Auto or disabled
Signal frequency	433 MHz
Clock	Auto or manual (disabled)
Humidity range	25% - 95%
Humidity resolution	1%
Memory	Min / Max relative humidity and temperature
Alarm duration	2 minutes
Snooze	8 minutes
Clock display	HH:MM:SS HH:MM: Day of Week
Hour format	12 / 24 hour format
Calendar	MM / DD or DD / MM language selectable: E, D, F, I and S
Power	3 x UM-3 (AA) 1.5 V batteries
REMOTE UNIT	
L x W x H	92 x 60 x 20 mm (3.6 x 2.4 x 0.8 in)
Weight	62 g (2.22 oz)
Transmission range	30 m (100 ft) unobstructed
Temperature range	-30°C to 60°C (-22°F to 140°F)
Power	2 x UM-4 (AAA) 1.5 V batteries

NOTE We recommend that you use alkaline batteries with this product for longer usage and lithium batteries in temperatures below freezing.

ABOUT OREGON SCIENTIFIC

Visit our website (www.oregonscientific.com) to learn more about Oregon Scientific products such as digital cameras; MP3 players; children's electronic learning products and games; projection clocks; health and fitness gear; weather stations; and digital and conference phones. The website also includes contact information for our Customer Care department in case you need to reach us, as well as frequently asked questions and customer downloads.

We hope you will find all the information you need on our website, however if you're in the US and would like to contact the Oregon Scientific Customer Care department directly, please visit: www2.oregonscientific.com/service/default.asp

OR

Call 1-800-853-8883.

For international inquiries, please visit: www2.oregonscientific.com/about/international.asp

FCC STATEMENT

This device complies with Part 15 of the FCC Rules. Operation is subject to the following two conditions: (1) This device may not cause harmful interference, and (2) This device must accept any interference received, including interference that may cause undesired operation.

This device complies with Part 15 of the FCC Rules. Operation is subject to the following two conditions: (1) This device may not cause harmful interference, and (2) This device must accept any interference received, including interference that may cause undesired operation.

WARNING Changes or modifications not expressly approved by the party responsible for compliance could void the user's authority to operate the equipment.

NOTE This equipment has been tested and found to comply with the limits for a Class B digital device, pursuant to Part 15 of the FCC Rules. These limits are designed to provide reasonable protection against harmful interference in a residential installation.

This equipment generates, uses and can radiate radio frequency energy and, if not installed and used in accordance with the instructions, may cause harmful interference to radio communications. However, there is no guarantee that interference will not occur in a particular installation. If this equipment does cause harmful interference to radio or television reception, which can be determined by turning the equipment off and on, the user is encouraged to try to correct the interference by one or more of the following measures:

- Reorient or relocate the receiving antenna.
- Increase the separation between the equipment and receiver.
- Connect the equipment into an outlet on a circuit different from that to which the receiver is connected.
- Consult the dealer or an experienced radio / TV technician for help.

DECLARATION OF CONFORMITY

The following information is not to be used as contact for support or sales. Please call our customer service number (listed on our website at www.oregonscientific.com), or on the warranty card for this product) for all inquiries instead.

We

Name: Oregon Scientific, Inc.
Address: 19861 SW 95th Ave., Tualatin, Oregon 97062 USA
Telephone No.: 1-800-853-8883

declare that the product

Product No.: BAR388HGA
Product Name: Wireless Weather Station with Temperature / Humidity Display and Self - Setting Atomic Clock
Manufacturer: IDT Technology Limited
Address: Block C, 9/F, Kaiser Estate, Phase 1, 41 Man Yue St., Hung Hom, Kowloon, Hong Kong

is in conformity with Part 15 of the FCC Rules. Operation is subject to the following two conditions: 1) This device may not cause harmful interference. 2) This device must accept any interference received, including interference that may cause undesired operation.

© 2006 Oregon Scientific. All rights reserved.
P/N: 086L004392-018