

CE

MADE
IN
USA

User's Guide

Shop on line at

omega.com[®]

Ω OMEGA[®]

www.omega.com

e-mail: info@omega.com

iSeries info: www.omega.com/specs/iSeries



iLD24-UTP, iLD44-UTP Big Display Universal Temperature & Process **Controller Manual**



OMEGAnet® On-Line Service www.omega.com	Internet e-mail info@omega.com
--	--

Servicing North America:

USA:
ISO 9001 Certified
One Omega Drive, P.O. Box 4047
Stamford CT 06907-0047
TEL: (203) 359-1660 FAX: (203) 359-7700
e-mail: info@omega.com

Canada:
976 Bergar
Laval (Quebec) H7L 5A1
TEL: (514) 856-6928 FAX: (514) 856-6886
e-mail: info@omega.ca

For immediate technical or application assistance:

USA and Canada: Sales Service: 1-800-826-6342 / 1-800-TC-OMEGA®
Customer Service: 1-800-622-2378 / 1-800-622-BEST®
Engineering Service: 1-800-872-9436 / 1-800-USA-WHEN®

Mexico and Latin America: TEL: (001)800-TC-OMEGA® FAX: (001) 203-359-7807
En Español: (001) 203-359-7803
e-mail: espanol@omega.com

Servicing Europe:

Benelux: Postbus 8034, 1180 LA Amstelveen, The Netherlands
TEL: +31 20 3472121 FAX: +31 20 6434643
Toll Free in Benelux: 0800 0993344
e-mail: sales@omegaeng.nl

Czech Republic: Frystatska 184, 733 01 Karviná
TEL: +420 59 6311899 FAX: +420 59 6311114
e-mail: info@omegashop.cz

France: 11, rue Jacques Cartier, 78280 Guyancourt
TEL: +33 1 61 37 29 00 FAX: +33 1 30 57 54 27
Toll Free in France: 0800 466 342
e-mail: sales@omega.fr

Germany/Austria: Daimlerstrasse 26, D-75392 Deckenpfronn, Germany
TEL: +49 7056 9398-0 FAX: +49 7056 9398-29
Toll Free in Germany: 0800 639 7678
e-mail: info@omega.de

United Kingdom:
ISO 9002 Certified
One Omega Drive
River Bend Technology Centre
Northbank, Irlam Manchester M44 5BD United Kingdom
TEL: +44 161 777 6611 FAX: +44 161 777 6622
Toll Free in England: 0800 488 488
e-mail: sales@omega.co.uk

It is the policy of OMEGA to comply with all worldwide safety and EMC/EMI regulations that apply. OMEGA is constantly pursuing certification of its products to the European New Approach Directives. OMEGA will add the CE mark to every appropriate device upon certification.

The information contained in this document is believed to be correct but OMEGA Engineering, Inc. accepts no liability for any errors it contains, and reserves the right to alter specifications without notice.

WARNING: These products are not designed for use in, and should not be used for, patient connected applications.



This device is marked with the international caution symbol. It is important to read the Setup Guide before installing or commissioning this device as it contains important information relating to safety and EMC.

TABLE OF CONTENTS

Part 1: Introduction.....	2
1.1 Description	2
1.2 Safety Considerations	3
1.3 Before You Begin	4
Part 2: Setup.....	5
2.1 Mounting	5
2.2 Rear Panel Connections	7
2.3 Electrical Installation	8
2.3.1 Power Connections	8
2.3.2 Thermocouple - Input Connection	9
2.3.3 Two / Three / Four Wire RTD-Hookups	10
2.3.4 Process Current - Wiring Hookup	11
2.3.5 Process Voltage - Wiring Hookup	11
2.3.6 Wiring Outputs - Wiring Hookup.....	12
Part 3: Operation: Configuration Mode	14
3.1 Introduction	14
Turning your Instrument On for the First Time	
Buttons Functions in Configuration Mode	
3.2 Menu Configuration	15
3.2.1 ID Number	16
3.2.2 Setpoints	17
3.2.3 Configuration Menu	18
3.2.4 Input Type Menu	18
Input Type (Thermocouple)	19
Input Type (RTD).....	20
Input Type (Process)	21
3.2.5 Reading Configuration Menu	21
3.2.6 Alarm 1 Menu	25
3.2.7 Analog Output (Retransmission) Menu.....	29
3.2.8 Alarm 2 Menu.....	32
3.2.9 Loop Break Time Menu / Field Calibration.....	33
3.2.10 Output 1 Menu	36
3.2.11 Output 2 Menu	43
3.2.12 Ramp and Soak Menu	46
3.2.13 ID Code Menu	48
3.2.14 Communication (Options) Menu	50
3.2.15 Display Color Selection Menu.....	56
Part 4: Specifications	59
Part 5: Factory Preset Values	62
CE APPROVAL INFORMATION	65

LIST OF FIGURES:

Figure 2.1	Mounting	5
Figure 2.2	Rear Panel Power and Output Connector Labels	7
Figure 2.3	Rear Panel Input Connector Labels	7
Figure 2.4	Main Power Connections	8
Figure 2.5	Inside Cover Rear View	8
Figure 2.6	Thermocouple Wiring Hookup	9
Figure 2.7	Two/Three/Four-wire RTD	
	a) RTD-1000 ohm and 500 ohm Wiring Hookup	10
	b) RTD-100 ohm Wiring Hookup	10
Figure 2.8	Process Current Wiring Hookup (Internal and External Excitation)	11
Figure 2.9	Process Voltage Wiring Hookup	
	a) Without Sensor Excitation	11
	b) With Sensor Excitation	11
Figure 2.10	Output Connections:	
	a) Mechanical Relay and SSR Outputs – Wiring Hook up	12
	b) Pulse and Analog Outputs – Wiring Hook up	12
Figure 2.11	Communication Output:	
	a) RS-232 Output – Wiring Hook up	12
	b) RS-485 Output – Wiring Hook up	12
Figure 2.12	Excitation Output	13
Figure 2.13	Snubber Circuits Wiring Hookup	13
Figure 3.1	Flow Chart for ID and Setpoints	15
Figure 3.2	Flow Chart for Configuration Menu	18
Figure 3.3	Flow Chart for Input Type Menu	18
Figure 3.4	Flow Chart for Reading Configuration	21
Figure 3.5	Flow Chart for Alarm 1	25
Figure 3.6	Flow Chart for Analog Output (Retransmission)	29
Figure 3.7	Flow Chart for Alarm 2	32
Figure 3.8	Flow Chart for Loop Break Time / Field Calibration	33
Figure 3.9	Flow Chart for Output 1	36
Figure 3.10	Flow Chart for Output 2	43
Figure 3.11	Flow Chart for Ramp and Soak	46
Figure 3.12	Flow Chart for ID Code	48
Figure 3.13	Flow Chart for Communication Option	50
Figure 3.14	Flow Chart for Display Color Selection	56

LIST OF TABLES:

Table 2.1	Front Panel Annunciators	6
Table 2.2	Rear Panel Connector	7
Table 2.3	TC Wire Color Chart	9
Table 3.1	Button Function in Configuration Mode	14
Table 3.2	Conversion Table	24
Table 4.1	Input Properties	61
Table 5.1	Factory Preset Values	62

NOTES, WARNINGS and CAUTIONS

Information that is especially important to note is identified by following labels:

- **NOTE**
- **WARNING or CAUTION**
- **IMPORTANT**
- **TIP**



Note E3

NOTE: Provides you with information that is important to successfully setup and use the Programmable Digital Meter.



CAUTION or WARNING: Tells you about the risk of electrical shock.



CAUTION, WARNING or IMPORTANT: Tells you of circumstances or practices that can effect the instrument's functionality and must refer to accompanying documents.



Tip E3

TIP: Provides you helpful hints.

PART 1

INTRODUCTION

1.1 Description

Note

This device can be purchased as monitor (read process value only) or as a controller.

- The iLD Big Display controller offers unparalleled flexibility in process measurement. Each unit allows the user to select the input type, from 10 thermocouple types (J, K, T, E, R, S, B, C, N and J DIN), Pt RTDs (100, 500 or 1000 Ω , with either 385 or 392 curve), DC voltage, or DC current. The voltage/current inputs are fully scalable to virtually all engineering units, with selectable decimal point, perfect for use with pressure, flow or other process input.
- The temperature control can be achieved by using on/off or PID heat/cool control strategy. Control can be optimized with an auto tune feature. The instrument offers a ramp to setpoint with timed soak period before switching off the output.
- The iLD Big Display device features a large, three color programmable display with capability to change a color every time the Alarm is triggered. The standard features include dual outputs with relay, SSR, dc pulse, analog voltage or current. Options include programmable RS-232 or RS-485 serial communication and excitation. Analog Output is fully scalable and may be configured as a proportional controller or retransmission to follow your display. Universal power supply accepts 100 to 240 Vac.

1.2 Safety Considerations



This device is marked with the international caution symbol. It is important to read this manual before installing or commissioning this device as it contains important information relating to Safety and EMC (Electromagnetic Compatibility).

This instrument is protected in accordance with Class I of EN 61010 (110/240 AC power connections). Installation of this instrument should be done by qualified personnel. In order to ensure safe operation, the following instructions should be followed.



This instrument has no power-on switch. An external switch or circuit-breaker shall be included in the building installation as a disconnecting device. It shall be marked to indicate this function, and it shall be in close proximity to the equipment within easy reach of the operator. The switch or circuit-breaker shall meet the relevant requirements of IEC 947-1 and IEC 947-3 (International Electrotechnical Commission). The switch shall not be incorporated in the main supply cord.



Furthermore, to provide protection against excessive energy being drawn from the main supply in case of a fault in the equipment, an overcurrent protection device shall be installed.



- Do not exceed voltage rating on the label located on the top of the instrument housing.
- Always disconnect power before changing signal and power connections.
- Do not use this instrument on a work bench without its case for safety reasons.
- Do not operate this instrument in flammable or explosive atmospheres.
- Do not expose this instrument to rain or moisture.
- Unit mounting should allow for adequate ventilation to ensure instrument does not exceed operating temperature rating.
- Use electrical wires with adequate size to handle mechanical strain and power requirements. Install without exposing bare wire outside the connector to minimize electrical shock hazards.

EMC Considerations

- Whenever EMC is an issue, always use shielded cables.
- Never run signal and power wires in the same conduit.
- Use signal wire connections with twisted-pair cables.
- Install Ferrite Bead(s) on signal wires close to the instrument if EMC problems persist.

Failure to follow all instructions and warnings may result in injury!

1.3 Before You Begin

Inspecting Your Shipment:

Remove the packing slip and verify that you have received everything listed. Inspect the container and equipment for signs of damage as soon as you receive the shipment. Note any evidence of rough handling in transit. Immediately report any damage to the shipping agent. The carrier will not honor damage claims unless all shipping material is saved for inspection. After examining and removing the contents, save the packing material and carton in the event reshipment is necessary.

Customer Service:

If you need assistance, please call the nearest Customer Service Department, listed in this manual.

Manuals, Software:

The latest Operation and Communication Manual as well as free configuration software and ActiveX controls are available from **the website listed in this manual or on the CD-ROM enclosed with your shipment.**





For first-time users: Refer to the QuickStart Manual for basic operation and set-up instructions.



If you have the Serial Communications/Ethernet Option you can easily configure the controller on your computer or on-line.

To Disable Outputs:

Standby Mode is useful during setup of the instrument or when maintenance of the system is necessary. When the instrument is in standby, it remains in the ready condition but all outputs are disabled. This allows the system to remain powered and ready to go.

When the instrument is in "RUN" Mode, **push  twice** to disable all outputs and alarms. It is now in "STANDBY" Mode. **Push  once** more to resume "RUN" Mode.



PUSH  TWICE to disable the system during an **EMERGENCY**.

To Reset the Meter:

When the controller is in the "MENU" Mode, **push  once** to direct controller one step backward of the top menu item.

Push  twice to reset controller, prior to resuming "Run" Mode except after "Alarms", that will go to the "Run" Mode without resetting the controller.

PART 2
SETUP
2.1 Mounting

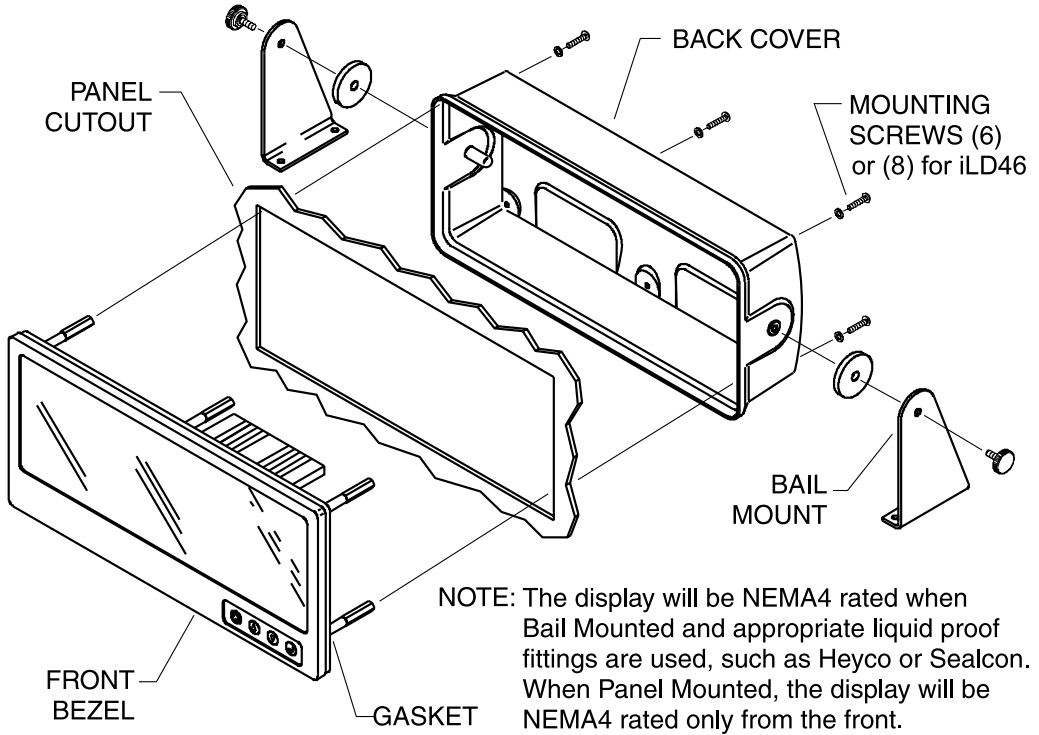

Figure 2.1 Mounting





Mounting iLD Big Display Through Panel:

1. Using the panel cutout diagram shown in your Quick Start Manual, cut an opening in the panel.
2. Remove six (or eight) screws at the back of iLD Big Display to remove back cover.
3. Insert the unit into the opening from the front of the panel so the gasket seals between the bezel and the front of the panel.
4. Pass all wiring through customer drilled holes in back cover and connect wiring to terminal blocks.
5. Align back cover to iLD Big Display and reinstall screws.

Mounting iLD Big Display on Bail:

1. Remove six (or eight) screws at the back of iLD Big Display to remove back cover.
2. Pass all wiring through customer drilled holes in back cover and connect wiring to terminal blocks.
3. Align back cover to iLD Big Display and reinstall screws.
4. Mark the location of mounting screws on the flat surface.
5. Be sure to leave enough room around the bail to allow for removal and rotation of the display.
6. The display can be rotated for the best viewing angle.

Table 2.1 Front Panel Annunciators

1	Output 1/Setpoint 1/ Alarm 1 indicator
2	Output 2/Setpoint 2/ Alarm 2 indicator
°C	°C unit indicator
°F	°F unit indicator
	Changes display to Configuration Mode and advances through menu items*
	Used in Program Mode and Peak Recall*
	Used in Program Mode and Valley Recall*
	Accesses submenus in Configuration Mode and stores selected values*

* See Part 3 Operation: Configuration Mode

2.2 Rear Panel Connections

The rear panel connections are shown in Figures 2.2 and 2.3.

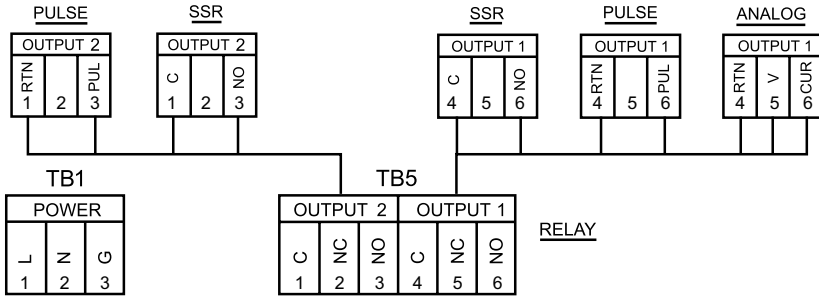

Figure 2.2 Rear Panel Power and Output Connections

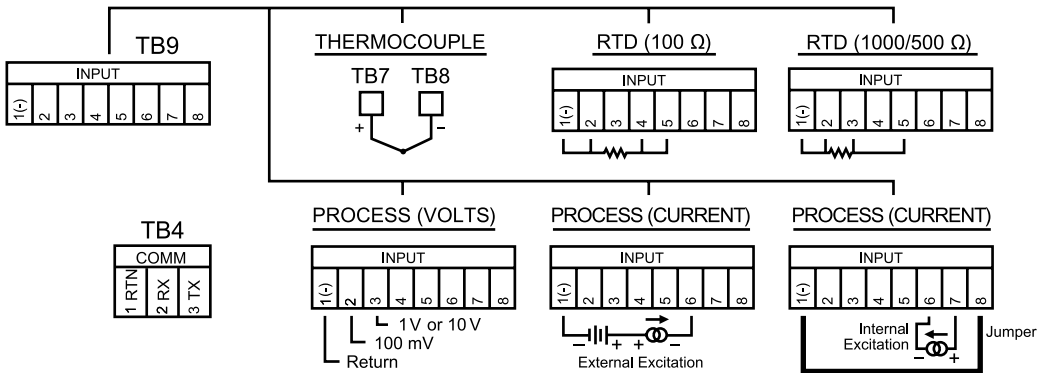

Figure 2.3 Rear Panel Input Connections

Table 2.2 Rear Panel Connector

POWER	AC Power Connector: All models
INPUT	Input Connector: TB7 & TB8 for TC models TB9 for PR (Process) & RTD models
OUTPUT 1	Based on one of the following models: Relay SPDT Solid State Relay Pulse Analog Output (Voltage and Current)
OUTPUT 2	Based on one of the following models: Relay SPDT Solid State Relay Pulse
OPTION	Based on one of the following models: RS-232C or RS-485

2.3 Electrical Installation

2.3.1 Power Connections

Caution: Do not connect power to your device until you have completed all input and output connections. Failure to do so may result in injury!

Connect the main power connections as shown in Figure 2.4.

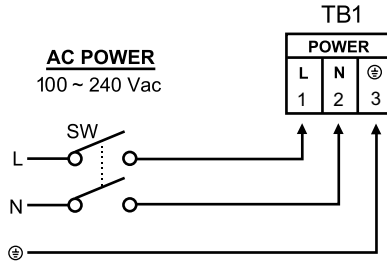

Figure 2.4 Main Power Connections

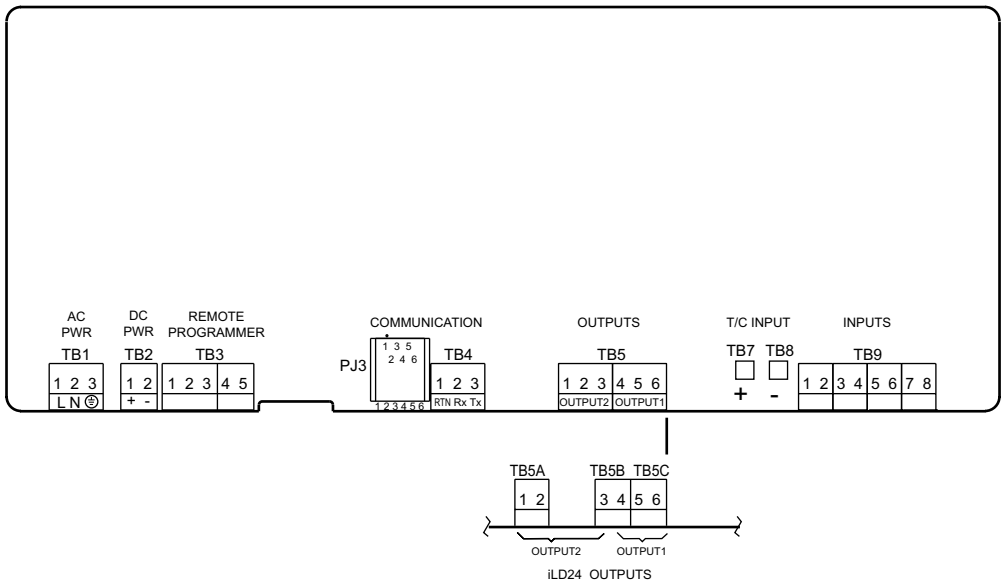

Figure 2.5 Inside Cover Rear View

2.3.2 Thermocouple

The figure below shows the wiring hookup for any thermocouple type. For example, for Type K hookup, connect the yellow wire to the TB7(+) terminal and the red wire to the TB8(-) terminal.

When configuring your controller, select Thermocouple and Thermocouple Type in the Input Type menu (see Part 3).

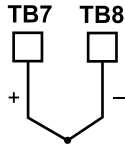

Figure 2.6 Thermocouple Wiring Hookup

Table 2.3 TC Wire Color Chart

TYPE	Input Connector		Jacket (external insulation)	
	Terminal 8 (-)	Terminal 7 (+)	Extension	Grade
J	Red	White	dark-Brown	Black
K	Red	Yellow	dark-Brown	Yellow
T	Red	Blue	dark-Brown	Blue
E	Red	Purple	dark-Brown	Purple
N	Red	Orange	dark-Brown	Brown
R	Red	Black	-	Green
S	Red	Black	-	Green
B	Red	Gray	-	Black

2.3.3 Two/Three/Four-Wire RTD

The figures below show the input connections and input connector jumpers (shown in bold lines) required to hookup a 2-, 3- or 4-wire RTD.

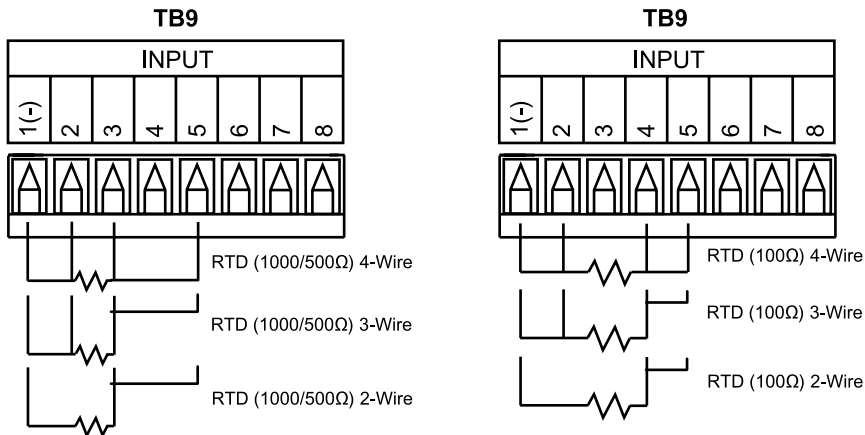

Figure 2.7

**a) RTD-1000 ohm and 500 ohm
Wiring Hookup**

b) RTD-100 ohm Wiring Hookup

The **two-wire** connection is simplest method, but does not compensate for lead-wire temperature change and often requires calibration to cancel lead-wire resistance offset.

The **three-wire** connection works best with RTD leads closely equal in resistance. The device measures the RTD, plus upper and lower lead drop voltage and the subtracts twice the measured drop in the lower supply current lead producing excellent lead-resistance cancellation for balanced measurements.

The **four-wire** RTD hookup is applicable to unbalanced lead resistance and enables the device to measure and subtract the lead voltage, which produces the best lead-resistance cancellation.

When configuring your controller, select RTD type and RTD value in the Input Type menu (see Part 3).



If the input wires of the meter get disconnected or broken, it will display **OPEN** "Input (+) Open" message except in case of 500/1000 Ω 2-wire RTD. In this case the display shows **-OPEN** "Input (-) Open" message. For safety purpose you may want to set up your alarm to be triggered when input is open. See Alarm 1 & 2 chapters for details.

2.3.4 Process Current

The figure below shows the wiring hookup for Process Current 0 – 20 mA.

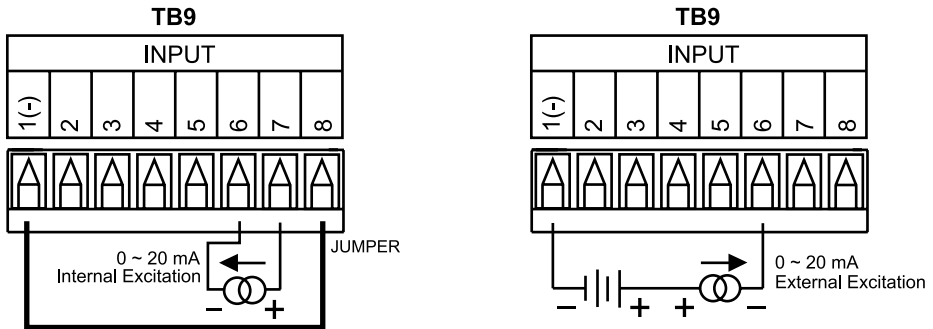

Figure 2.8 Process Current Wiring Hookup (Internal and External Excitation)

When configuring your instrument, select Process Type in the Input Type Menu (see Part 3).

2.3.5 Process Voltage

The figure below shows the wiring hookup for Process Voltage 0 – 100 mV, 0 – 1 V, 0 – 10 V.

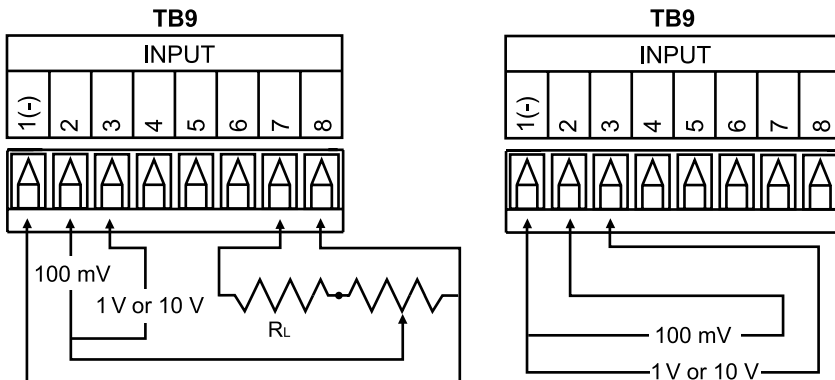

Figure 2.9 a) Process Voltage Wiring Hookup with Sensor Excitation b) Process Voltage Wiring Hookup without Sensor Excitation

R_L - Voltage limiting resistor, which allows conversion of the 24 Vdc internal excitation voltage to the appropriate process input value. For instance: if the potentiometer value is equal to 10 k Ω , the minimum R_L is 14 k Ω for 10 V process input.

When configuring your instrument, select Process Type in the Input Type Menu (see Part 3).

2.3.6 Wiring Outputs

This meter has two, factory installed, outputs. The SPDT Mechanical Relay, SPST Solid State Relay, Pulse and Analog Output Connection are shown below.

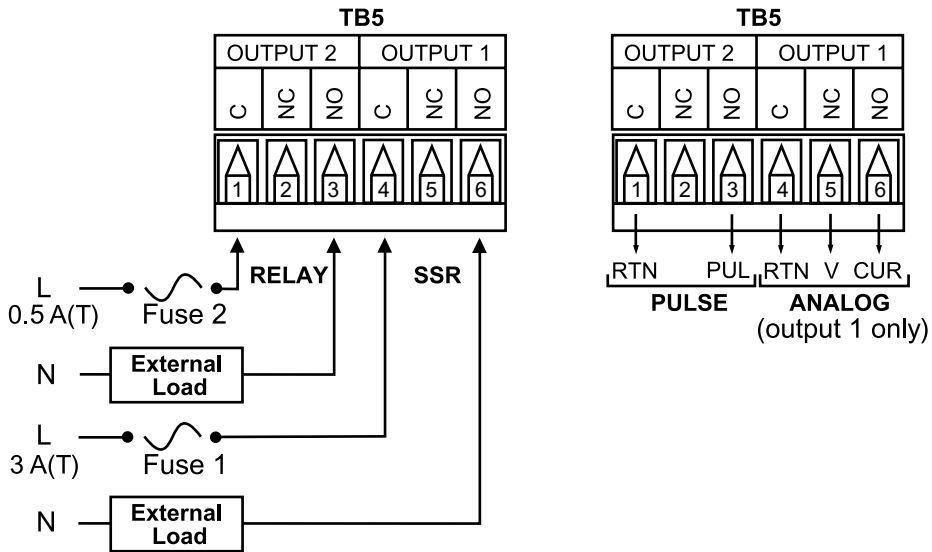

Figure 2.10
a) Mechanical Relay and SSR
Outputs Wiring Hookup

b) Pulse and Analog
Outputs Wiring Hookup

This device may have a programmable communication output. The RS-232 and RS-485 Output Connection are shown below.



Figure 2.11
a) RS-232 Output Wiring Hookup b) RS-485 Output Wiring Hookup

This device may also have an excitation output.

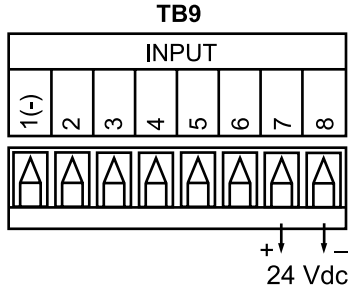

Figure 2.12 Excitation Output



Note Excitation is not available if communication option is installed.

This device has snubber circuits designed to protect the contacts of the mechanical relays when it switches to inductive loads (i.e. solenoids, relays). These snubbers are internally connected between the Common (C) and Normally Open (NO) relay contacts of Output 1 and Output 2.



If you have an inductive load connected between Common (C) and Normally Closed (NC) contacts of the mechanical relays and you want to protect them from the rush current during the switching period, you have to connect an external snubber circuit between Common (C) and Normally Closed (NC) contacts as indicated in the figure below.

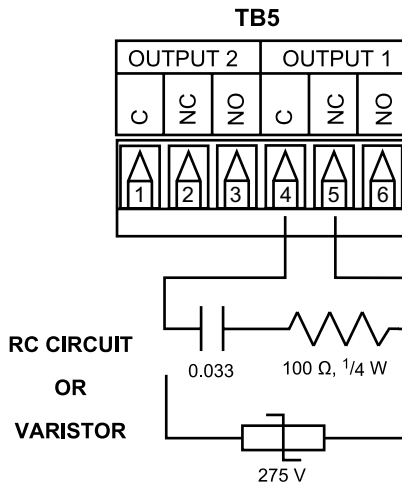

Figure 2.13 Snubber Circuits Wiring Hookup

PART 3

OPERATION: Configuration Mode



















3.1 Introduction

The instrument has two different modes of operation. The first, Run Mode, is used to display values for the Process Variable, and to display or clear Peak and Valley values. The other mode, Menu Configuration Mode, is used to navigate through the menu options and configure the controller. Part 3 of this manual will explain the Menu Configuration Mode. For your instrument to operate properly, the user must first "program" or configure the menu options.

Turning your Controller On for the First Time

The device becomes active as soon as it is connected to a power source. It has no On or Off switch. The device at first momentarily shows the software version number, followed by reset **RSE**, and then proceeds to the Run Mode.

Table 3.1 Button Function in Configuration Mode

 MENU	<ul style="list-style-type: none">• To enter the Menu, the user must first press  button.• Use this button to advance/navigate to the next menu item. The user can navigate through all the top level menus by pressing .• While a parameter is being modified, press  to escape without saving the parameter.
 (UP)	<ul style="list-style-type: none">• Press the up  button to scroll through "flashing" selections. When a numerical value is displayed press this key to increase value of a parameter that is currently being modified.• Holding the  button down for approximately 3 seconds will speed up the rate at which the set point value increments.• In the Run Mode press  causes the display to flash the PEAK value – press again to return to the Run Mode.
 (DOWN)	<ul style="list-style-type: none">• Press the down  button to go back to a previous Top Level Menu item.• Press this button twice to reset the controller to the Run Mode.• When a numerical value is flashing (except set point value) press  to scroll digits from left to right allowing the user to select the desired digit to modify.• When a setpoint value is displayed press  to decrease value of a setpoint that is currently being modified. Holding the  button down for approximately 3 seconds will speed up the rate at which the setpoint value is decremented.• In the Run Mode press  causes the display to flash the VALLEY value – press again to return to the Run Mode.
 ENTER	<ul style="list-style-type: none">• Press the enter  button to access the submenus from a Top Level Menu item.• Press  to store a submenu selection or after entering a value — the display will flash a SEEd message to confirm your selection.• To reset flashing Peak or Valley press .• In the Run Mode, press  twice to enable Standby Mode with flashing SEEd.



Reset: Except for Alarms, modifying any settings of the menu configuration will reset the instrument prior to resuming Run Mode.

3.2 Menu Configuration



It is recommended that you put the controller in the Standby Mode for any configuration change other than Setpoints & Alarms.

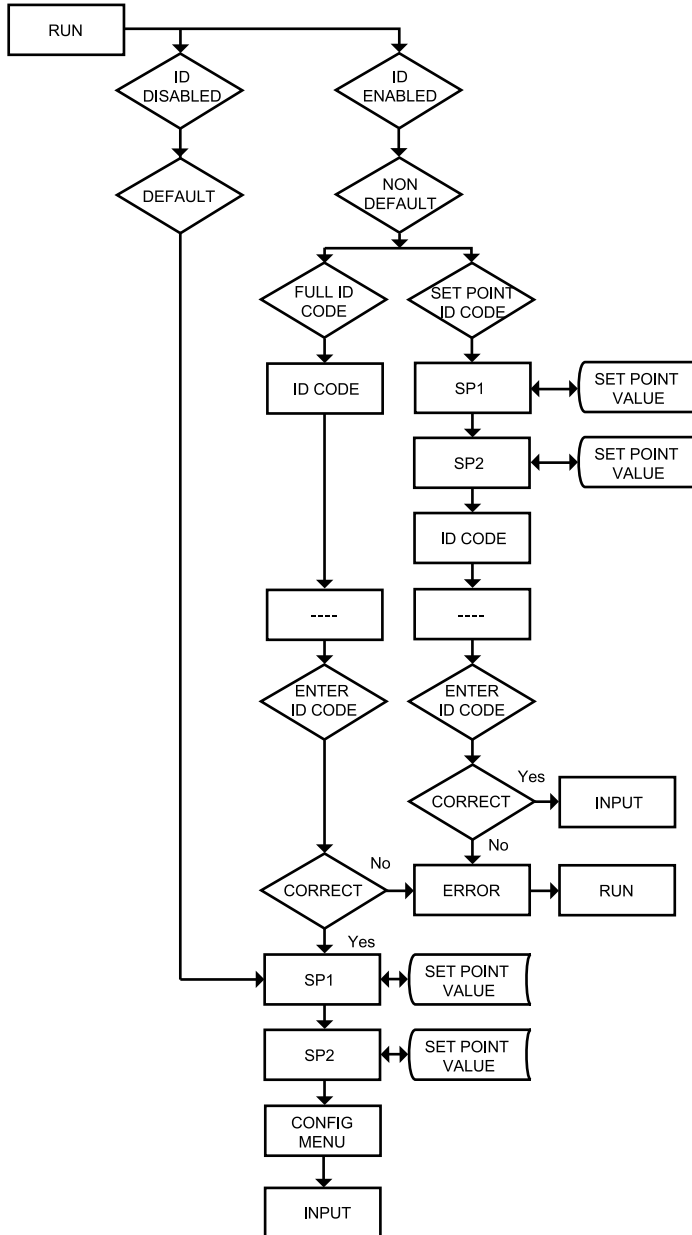

Figure 3.1 Flow Chart for ID and Setpoints

3.2.1 ID Number









SEE ID MENU SELECTION IN CONFIGURATION SECTION FOR ENABLE/DISABLE OR CHANGE ID CODE.

Note ESP If ID Code is **Disabled** or set as **Default** (0000) the menu will skip ID step to Setpoint Menu.

If ID Code is set to **Full Security Level** and user attempts to enter the Main Menu, they will be prompted for an ID Code.









If ID Code is set to **Setpoint/ID Security Level** and user attempts to enter the Configuration Menu, they will be prompted for an ID Code.

ENTERING YOUR NON-DEFAULT FULL SECURITY ID NUMBER.

- Press  1) Display shows **ID**.
- Press  2) Display advances to **----**.
- Press  &  3) Press  to increase digit 0-9. Press  to activate next digit (flashing). Continue to use  and  to enter your 4-digit ID code.
- Press  4) If the correct ID code is entered, the menu will advance to the Setpoint 1 Menu, otherwise an error message **ERR** will be displayed and the instrument will return to the Run Mode.

Note ESP To change ID Code, see ID Menu in the Configuration section.

ENTERING YOUR NON-DEFAULT SETPOINT/ID SECURITY ID NUMBER.







- Press  5) Display shows **SP1** Setpoint 1 Menu.
- Press  6) Display shows **SP2** Setpoint 2 Menu.
- Press  7) Display shows **ID** ID Code Menu.
- Press  8) Display advances to **----**.
- Press  &  9) Use  and  to change your ID Code.
- Press  10) If correct ID Code is entered, the display will advance to the **INPE** Input Menu, otherwise the error message **ERR** will be displayed and the controller will return to the Run Mode.



Note ESP To prevent unauthorized tampering with the setup parameters, the instrument provides protection by requiring the user to enter the ID Code before allowing access to subsequent menus. If the ID Code entered does not match the ID Code stored, the controller responds with an error message and access to subsequent menus will be denied.







Tip ESP Use numbers that are easy for you to remember. If the ID Code is forgotten or lost, call customer service with your serial number to access and reset the default to **0000**.

3.2.2 Set Points





SETPOINT 1:



- Press  1) Press , if necessary until **SP 1** prompt appears.
Press  2) Display shows previous value of "Setpoint 1".
Press  &  3) Press  and  to increase or decrease Setpoint 1 respectively.



Note  Holding  &  buttons down for approximately 3 seconds will speed up the rate at which the Setpoint value increments or decrements.

- Press  &  4) Continue to use  and  to enter your 4-digit Setpoint 1 value.
Press  5) Display shows **SEtPd** stored message momentarily and then advances to **SP 2** only, if a change was made, otherwise press  to advance to **SP 2** Setpoint 2 Menu.

SETPOINT 2:

- Press  6) Display shows previous value of "Setpoint 2".
Press  &  7) Press  and  to increase or decrease Setpoint 2 respectively.

Note  Holding  &  buttons down for approximately 3 seconds will speed up the rate at which the setpoint value increments or decrements.

- Press  8) Display shows **SEtPd** stored message momentarily and then advances to **CNFg** only, if a change was made, otherwise press  to advance to **CNFg** Configuration Menu.

3.2.3 Configuration Menu

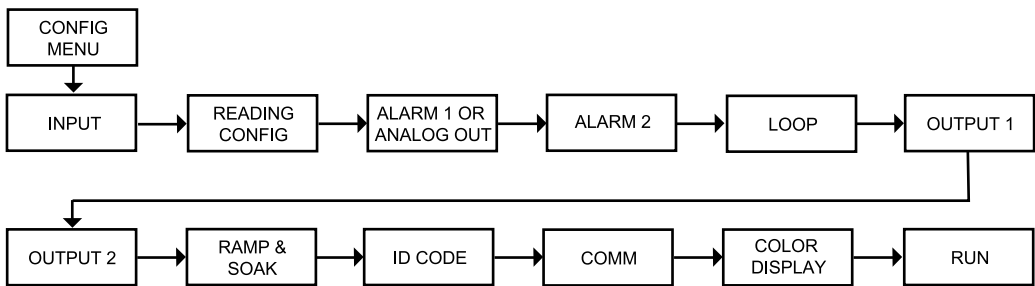

Figure 3.2 Flow Chart for Configuration Menu

Enter Configuration Menu:

- Press 1) Press , if necessary, until **CONF** prompt appear.
- Press 2) Display advances to **INPE** Input Menu.
- Press 3) Pressing and releasing to scroll through all available menus of Configuration section.

3.2.4 Input Type Menu

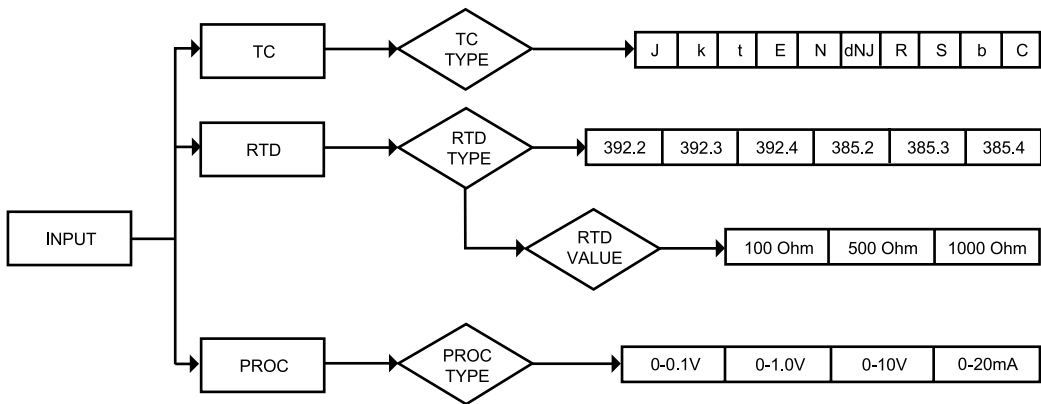











Figure 3.3 Flow Chart for Input Type Menu

Input Type (Thermocouple)

ENTER INPUT TYPE MENU:

- Press  1) Press , if necessary, until **CONF** prompt appears.
- Press  2) Display advances to **INPE** Input Menu.
- Press  3) Display flashes **E.c**, **RTd** or **PROC** (Thermocouple, RTD or Process). If the displayed input type is **E.c**, press  to skip to step 6 (**E.c** stops flashing).

THERMOCOUPLE SUBMENU:

- Press  4) Scroll through the available selection to **E.c** (flashing).
- Press  5) Display shows **SERR** stored message momentarily and then **E.c** (not flashing).
- Press  6) Display flashes previous thermocouple type selection. i.e. **J** (see below for types).
- Press  7) Scroll through the available thermocouple types to the selection of your choice.
- Press  8) Display shows **SERR** stored message momentarily and then advances to the **RDG** Reading Configuration Menu.



Use the Input Type (Thermocouple) (RTD) or (Process) and verify your Electrical Installation (see **Section 2.3**).

Thermocouple Types: J, K, T, E, N, DIN J, R, S, B, C
Display: **J** **K** **E** **E** **N** **DINJ** **R** **S** **B** **C**

Input Type (RTD)

ENTER INPUT TYPE MENU:

- Press **↻** 1) Press **↻**, if necessary, until **CONF** prompt appears.
Press **↻** 2) Display advances to **INPE** Input Menu.
Press **↻** 3) Display flashes **TC**, **RTD** or **PROC** (Thermocouple, RTD or Process). If the displayed input type is **RTD**, press **↻** to skip to step 6 (**RTD** stops flashing).

RTD SUBMENU:

- Press **▲** 4) Scroll through the available selection to **RTD** (flashing).
Press **↻** 5) Display shows **SETRd** stored message momentarily and then **RTD** (not flashing).
Press **↻** 6) Display flashes previous RTD type selection i.e. **392.2** (see below for RTD types selection).
Press **▲** 7) Scroll through the available RTD types to the selection of your choice.
Press **↻** 8) Display shows **SETRd** stored message momentarily and then advances to **RTD** RTD value.

RTD Types: 392 385 Two, Three or Four-wire
Display: **392.2**, **392.3**, **392.4**, **385.2**, **385.3**, **385.4**

Note Last digit indicates: 2-, 3- or 4-wire input.

RTD VALUE SUBMENU:

- Press **↻** 9) Display flashes previous RTD value selection i.e. **100.** (see below for RTD value selection).
Press **▲** 10) Scroll through the available RTD values to the selection of your choice.
Press **↻** 11) Display shows **SETRd** stored message momentarily and then advances to **RdG** Reading Configuration Menu.

RTD Values: 100 ohm 500 ohm 1000 ohm
Display: **100.** **500.** **1000**

Input Type (Process)

ENTER INPUT TYPE MENU:

- Press **⏪** 1) Press **⏪**, if necessary, until **ENFG** prompt appears.
- Press **⏩** 2) Display advances to **INPE** Input Menu.
- Press **⏪** 3) Display flashes **E.C.**, **RTD** or **PROC** (Thermocouple, RTD or Process). If the displayed input type is **PROC**, press **⏪** to skip to step 6 (**PROC** stops flashing).

PROCESS SUBMENU:

- Press **⏩** 4) Scroll through the available selection to **PROC** (flashing).
- Press **⏪** 5) Display shows **STRD** stored message momentarily and then **PROC** (not flashing).
- Press **⏪** 6) Display flashes previous Process type selection. i.e. **0-10** (see below for Process types selection).
- Press **⏩** 7) Scroll through the available Process types to the selection of your choice.
- Press **⏪** 8) Display shows **STRD** stored message and then advances to **RDG** Reading Configuration Menu.

Process Types: 100 mV 1 V 10 V 0 – 20 mA
 Display: **0-0.1** **0-1.0** **0-10** **0-20**

For 4-20 mA Input select 0-20 mA then adjust the Input/Reading accordingly. To adjust 4-20 mA input, see example under INPUT/READING submenu. The factory preset value is 4-20 mA.

3.2.5 Reading Configuration

Note ^{13A}

It is recommended that you put the controller in the Standby Mode for any configuration change other than Setpoints & Alarms.

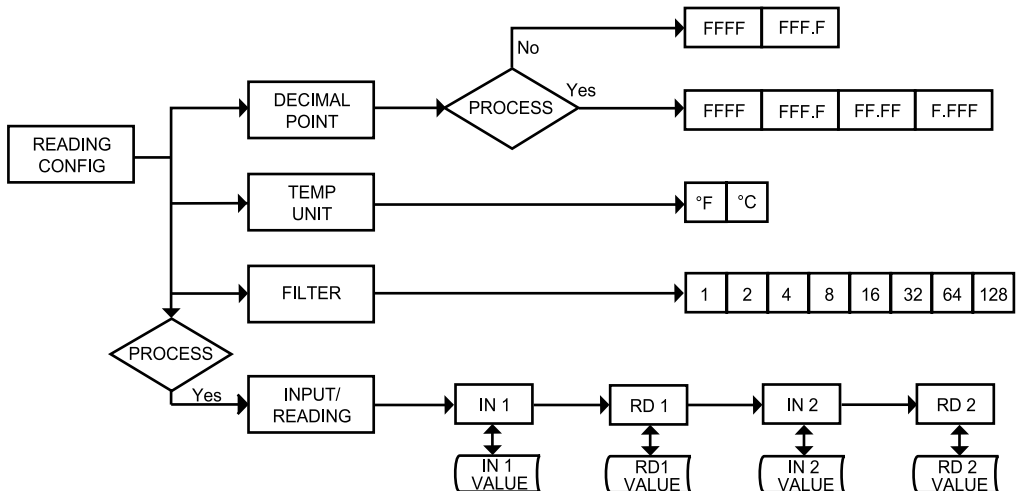









Figure 3.4 Flow Chart for Reading Configuration Menu

ENTER READING CONFIGURATION MENU:

- Press  1) Press , if necessary, until **ENFG** prompt appears.
- Press  2) Display advances to **INPE** Input Menu.
- Press  3) Display advances to **RdG** Reading Configuration Menu.
- Press  4) Display advances to **DEC** Decimal Point.



DECIMAL POINT SUBMENU:

- Press  5) Display flashes previous selection for Decimal location.
- Press  6) Scroll through the available selections and choose Decimal location: **FFFF** or **FFF.F** (also **FF.FF** and **F.FFF** — if **PROC** Process type was selected in the Input Type Menu).
- Press  7) Display shows **SErD** stored message momentarily and then advances to **TEMP** Temperature Unit.





Note 

Decimal Point for Process Input Type is passive.

TEMPERATURE UNIT SUBMENU:

- Press  8) Display flashes previous Temperature Unit selection.
- Press  9) Scroll through the available selections to the Temperature Unit of your choice: **F** or **C**.
- Press  10) Display shows **SErD** stored message momentarily and then advances to **FLER** Filter Constant.

FILTER CONSTANT SUBMENU:

- Press  11) Display flashes previous selection for Filter Constant.
- Press  12) Scroll through the available selections:
0001, 0002, 0004, 0008, 0016, 0032, 0064, 0128
- Press  13) Display shows **SErD** stored message momentarily only, if change was made, otherwise press  to advance to the next menu.

Note 

If Process was selected in the Input Type Menu the display will advance to **IN.Rd** Input/Reading Submenu, otherwise the display advances to the **ALR 1** Alarm 1 Menu.

The Filter Constant Submenu allows the user to specify the number of readings stored in the Digital Averaging Filter.

Tip 

For PID control select filter value 0001-0004. A filter value of 2 is approximately equal to 1 second RC low pass time constant.

Reading Configuration (If Process was selected)

INPUT/READING (SCALE AND OFFSET) SUBMENU:

Input Voltage or Current can be converted or scaled into values appropriate for the process or signal being measured. So, a reading may be displayed, for example, in units of weight or velocity instead of in amperes or volts.

The instrument determines Scale and Offset values based on two user-provided input values entered with the corresponding readings. Note that “In1” Input 1 and “In2” Input 2 are represented and entered as a product of the input voltage/current and the conversion number from the Table 3.1.

Note The following instructions include details for a specific scenario in which a 4-20 mA input (in the 20 mA Process Mode) is to be represented as a measurement of 0-100 percent.

- Press **↻** 14) Press **↻** at the **IN.Rd** prompt. Display shows **IN 1** Input 1 submenu.
- Press **↻** 15) Display shows Input 1 value with 1st digit flashing.
- Press **▲ & ▼** 16) Use **▲** and **▼** buttons to enter **IN 1** value.
The **IN 1** value = min. input value * conversion number.

Note Disregard the position of the decimal point, such that 2000 counts may actually appear as “200.0”, “20.00”, or “2.000”.

Example: 4 mA as $4(\text{mA}) \times 500 = 2000$.

- Press **↻** 17) Display advances to **Rd 1** Reading 1 Submenu.
- Press **▲ & ▼** 18) Use **▲** and **▼** buttons to enter **Rd 1** value.
This value represents **IN 1** in terms of some meaningful engineering units. To show the 4 mA as zero percent enter **Rd 1** value = 0000.
Example: **Rd 1** value = 0000.
- Press **↻** 19) Display **IN 2** Input 2 Submenu.
- Press **↻** 20) Display shows Input 2 value with 1st digit flashing.
The **IN 2** value = max. input value * conversion number.
Example: $20(\text{mA}) \times 500 = 10000$ (9999).
- Press **▲ & ▼** 21) Use **▲** and **▼** buttons to enter **IN 2** value.
- Press **↻** 22) Display advances to **Rd 2** Reading 2 Submenu.
- Press **▲ & ▼** 23) Use **▲** and **▼** buttons to enter **Rd 2** value.
Example: **Rd 2** value = 0100.
- Press **↻** 24) Display flashes **SEtRd** stored message momentarily and then advances to **ALR 1** only, if change was made, otherwise press **↻** to advance to **ALR 1** Alarm 1 Menu.



Conversion number is a coefficient of conversion between input values and real full display range (10000 counts, shown as 9999). See Table 3.2 below for proper conversion number.

Table 3.2 Conversion Table

RANGE	CONVERSION NUMBER
100 mV	$10000 / (100 \times 1) = 100$
1 V	$10000 / (1000 \times 1) = 10$
10 V	$10000 / (1000 \times 10) = 1$
0 -20 mA	$10000 / (20 \times 1) = 500$

Example =

$$0 - 1 \text{ V} = 0 - 100.0$$

$$\text{In } 1 = 0$$

$$\text{Rd } 1 = 0$$

$$\text{Inp } 2 = 9999$$

$$\text{Rd } 2 = 100.0$$

3.2.6 Alarm 1

This unit is equipped with two physical outputs that can only be configured as follows: **Alarm 1 & Alarm 2**, **Alarm 1 & Output 2**, **Output 1 & Alarm 2**, **Output 1 & Output 2**, **Analog Out 1 & Alarm 2**, **Analog Out 1 & Output 2**. Analog Out available only if Analog Output Option board is factory installed.

Note If Analog Output Option is installed, the controller will skip Alarm 1 Menu item to Analog Output.

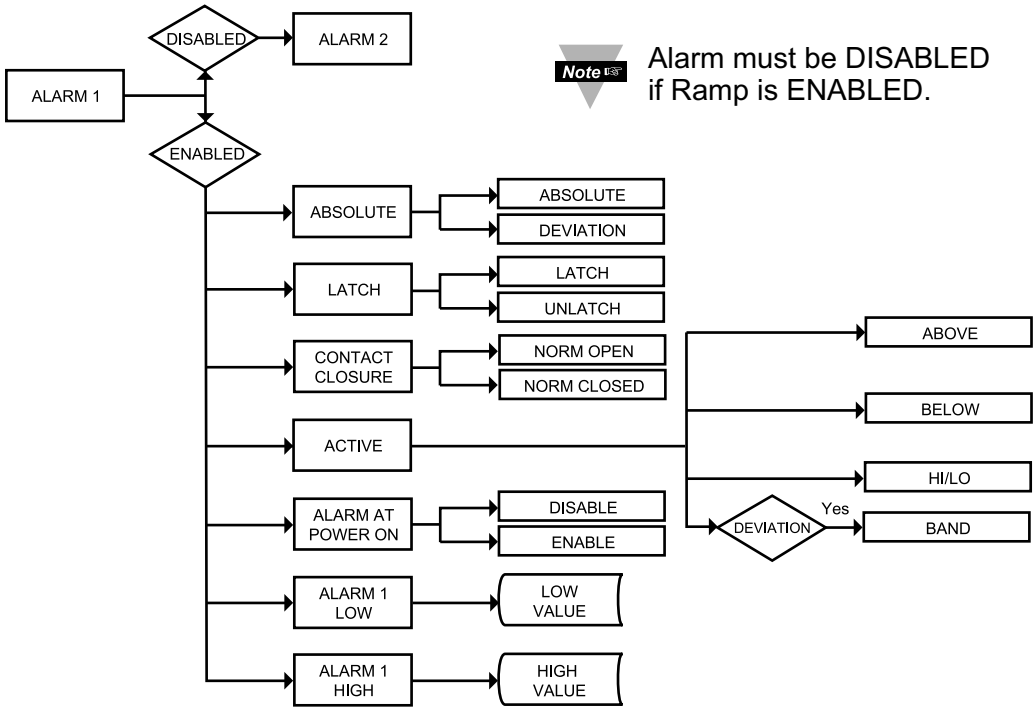



Note Alarm must be DISABLED if Ramp is ENABLED.

Figure 3.5 Flow Chart for Alarm 1

ENTER ALARM 1 MENU:

- Press **⏪** 1) Press **⏪**, if necessary, until **ENFC** prompt appears.
- Press **⏩** 2) Display advances to **INPE** Input Menu.
- Press **⏪** 3) Press **⏪**, if necessary, until Display advances to **ALR 1** Alarm 1 Menu.
- Press **⏩** 4) Display advances to Alarm 1 **ENBL** Enable or **DSBL** Disable Submenu and flashes the previous selection.





ALARM 1 ENABLE/DISABLE SUBMENU:

- Press  5) Scroll through the available selection until **ENBL** displays to use Alarm 1.
- Press  6) Display shows **SETRd** stored message momentarily and then advances to **ABSd** only if it was changed, otherwise press  to advance to **ABSd** Alarm 1 Absolute/Deviation Submenu.

 **Note**

If **dsbl** Alarm 1 **Disabled** was selected, all submenus of Alarm 1 Menu will be skipped and meter advances to **ALRE** Alarm 2 Menu. If **ENBL** Alarm 1 **Enabled** was selected, Output 1 would be automatically Disabled, and reassigned as Alarm 1.





ALARM 1 ABSOLUTE/DEVIATION SUBMENU:



- Press  7) Display flashes previous selection. Press  to **ABSd** Absolute or **DEY** Deviation.
- Press  8) Display shows **SETRd** stored message momentarily and then advances to **LECH** only if it was changed, otherwise press  to advance to **LECH** Alarm 1 Latch/Unlatch Submenu.

Absolute Mode allows Alarm 1 to function independently from Setpoint 1. If the process being monitored does not change often, then "Absolute" Mode is recommended.

Deviation Mode allows changes to Setpoint 1 to be made automatically to Alarm 1. Deviation mode is typically the ideal mode if the process temperature changes often. In Deviation Mode, set Alarm 1 a certain number of degrees or counts away from Setpoint 1 — this relation remains fixed even if Setpoint 1 is changed.





ALARM 1 LATCH/UNLATCH SUBMENU:

- Press  9) Display flashes previous selection. Press  to **LECH** Latched or **UNLE** Unlatched.
- Press  10) Display shows **SETRd** stored message momentarily and then advances to **LECL** only, if it was changed, otherwise press  to advance to **LECL** Contact Closure Submenu.

Latched Mode: Relay remains "latched" until reset. To reset already latched alarm, select Alarm Latch and press Max twice (i.e. Unlatch and then back to Latch) or from a Run Mode, push  twice to put the controller in Standby Mode and then push  one more time to return to the Run Mode.

Unlatched Mode: Relay remains latched only as long as the alarm condition is true.





CONTACT CLOSURE SUBMENU:

- Press  11) Display flashes previous selection. Press  to **N.C.** Normally Closed or **N.O.** Normally Open.
- Press  12) Display shows **SEtRd** stored message momentarily and then advances to **ACTN** only if it was changed, otherwise press  to advance to **ACTN** Active Submenu.

Normally Open: If this feature is selected, then the relay is "energized" only when an alarm condition occurs.

Normally Closed: "Fail Safe" Mode. Relay is energized under "normal" conditions and becomes de-energized during alarm or power failure.

ACTIVE SUBMENU:

- Press  13) Display flashes previous selection. Press  to scroll through the available selections: **AbOv** Above, **bELo** Below, **HI.Lo** HI/Low and **bAND** Band. (Band is active if **DEv** Deviation was selected).
- Press  14) Display shows **SEtRd** stored message momentarily and then advances to **A.P.ON** only if it was changed, otherwise press  to advance to **A.P.ON** Alarm Enable/Disable at Power On Submenu.





Above: Alarm 1 condition triggered when the process variable is greater than the Alarm Hi Value (Low value ignored).

Below: Alarm 1 condition triggered when the process variable is less than the Alarm Low Value (Hi value ignored).

Hi/Low: Alarm 1 condition triggered when the process variable is less than the Alarm Low Value or above the Hi Value.

Band: Alarm 1 condition triggered when the process variable is above or below the "band" set around Setpoint 1. Band equals Hi Value (Low Value ignored). A "band" is set around the Setpoint by the instrument only in the "Deviation" Mode.









ALARM ENABLE/DISABLE AT POWER ON:

- Press  15) Display flashes previous selection. Press  to **ENBL** enable or **DSBL** disable.
- Press  16) Display shows **SEtP** stored message. momentarily and then advances to **ALR.L** only if it was changed, otherwise press  to advance to the **ALR.L** Alarm 1 Low Value Submenu.











If the alarm is enabled at Power On, the alarm will be active right after reset. If the alarm is disabled at Power On, the alarm will become enabled when the process value enters the non alarm area. The alarm is not active while the process value is approaching Setpoint 1.

ALARM 1 LOW VALUE SUBMENU:

- Press  17) Display flashes 1st digit of previous value. Use  and  to enter new value.
- Press  &  18) Use  and  to enter Alarm 1 Low Value.
- Press  19) Display shows **SEtP** storage message momentarily and then advances to **ALR.H** only, if it was changed, otherwise press  to advance to **ALR.H** Alarm 1 Hi Value Submenu.

ALARM 1 HI VALUE SUBMENU:

- Press  20) Display flashes 1st digit of previous value. Use  and  to enter new value.
- Press  &  21) Use  and  to enter Alarm1 Hi Value.
- Press  22) Display shows **SEtP** stored message momentarily and then advances to the next menu only, if it was changed, otherwise press  to advance to the next menu.

3.2.7 Analog Output (Retransmission)

Note Analog Output can be configured as Retransmission or Control outputs. In this section we will discuss Retransmission Output.

This unit is equipped with two physical outputs that can only be configured as follows: **Alarm 1 & Alarm 2, Alarm 1 & Output 2, Output 1 & Alarm 2, Output 1 & Output 2, Analog Out 1 & Alarm 2, Analog Out 1 & Output 2.** Analog Output is available only, if Analog Output Option board is factory installed.

Note If Analog Output Option is not installed, the instrument will skip to Alarm 2 Menu.

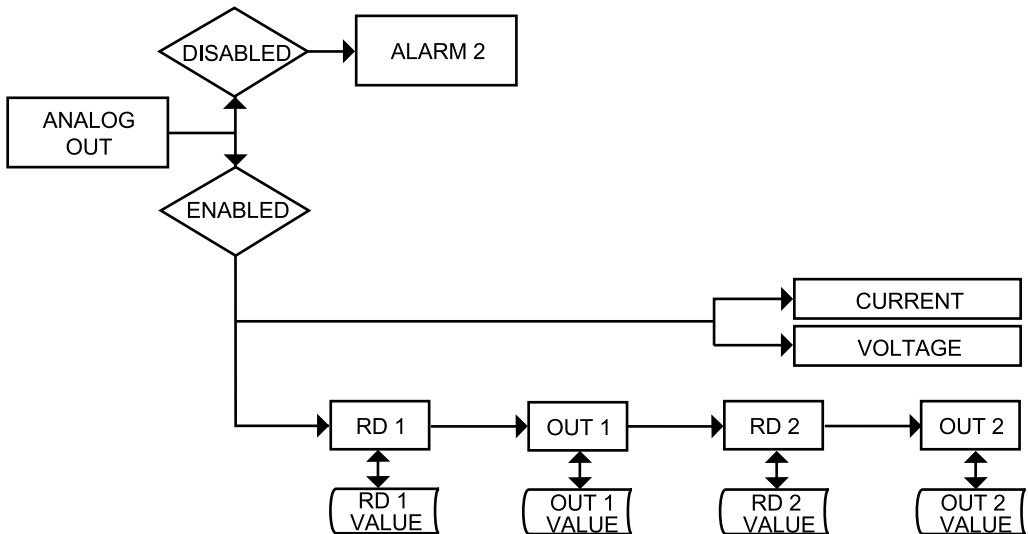

Figure 3.6 Flow Chart for Analog Output (Retransmission)

ENTER ANALOG OUTPUT MENU:

- Press **⏏** 1) Press **⏏**, if necessary, until **ENFG** prompt appears.
- Press **⏏** 2) Display advances to **INPE** Input Menu.
- Press **⏏** 3) Press **⏏**, if necessary, until Display advances to **ANLG** Analog Output Menu.
- Press **⏏** 4) Display advances to Analog Output **ENBL** Enable or **DSBL** Disable Submenu and flashes the previous selection.

ANALOG OUTPUT ENABLE/DISABLE SUBMENU:

- Press **▲** 5) Scroll through the available selection until **ENBL** displays to use Analog Output Retransmission (output proportional to the input signal).
- Press **▼** 6) Display shows **STRD** stored message momentarily and then advances to **CURR** or **VOLT** Submenu only if it was changed, otherwise press **▼** to advance to **CURR** or **VOLT** Current/Voltage Submenu.

Note If **DSBL** Analog Output **Disabled** was selected, all submenus of Analog Output Menu will be skipped and the meter will advance to **ALR2** Alarm 2 Menu. If **ENBL** Analog Output **Enabled** was selected, Output 1 would be automatically **Disabled**, and reassigned as Analog Output.

CURRENT/VOLTAGE SUBMENU:

- Press **▼** 7) Display flashes **CURR** Current or **VOLT** Voltage.
- Press **▲** 8) Scroll through the available selection: Current or Voltage (Example **VOLT**).
- Press **▼** 9) Display shows **STRD** stored message momentarily and then advances to **Rd1** Submenu only if it was changed, otherwise press **▼** to advance to **Rd1** Reading 1 Submenu.

READING 1:

- Press **▼** 10) Display flashes 1st digit of previous “Reading 1” value.
- Press **▲** & **▼** 11) Enter “Reading 1” value. (Example 0000)
- Press **▼** 12) Display advances to **OUT.1** Out 1 Submenu.

OUT 1:

- Press **▼** 13) Display flashes 1st digit of previous “Out 1” value.
- Press **▲** & **▼** 14) Enter “Out 1” value. (Example 00.00)
- Press **▼** 15) Display advances to **Rd.2** Reading 2 Submenu.

READING 2:

- Press **▼** 16) Display flashes 1st digit of previous “Reading 2” value.
- Press **▲** & **▼** 17) Enter “Reading 2” value. (Example 9999)
- Press **▼** 18) Display advances to **OUT.2** Out 2 Submenu.

OUT 2:

- Press **▼** 19) Display flashes 1st digit of previous “Out 2” value.
- Press **▲** & **▼** 20) Enter “Out 2” value. (Example 10.00)
- Press **▼** 21) Display advances to the **ALR2** Alarm 2 Menu.

Note The above example is for 0-10 V of the entire range of the Process Input and Analog Output. For 0-20 mA output you need to set “Analog Type” to Current and OUT 2 to 20.00.

Accuracy of Analog Output board is +/-1% of FS (Full Scale) when following conditions are satisfied:

1. The input is not scaled below 1% of Input FS (10 mV @ 1 V or 0.2 mA @ 20 mA input ranges).
2. Analog Output is not scaled below 3% of Output FS (300 mV @ 10 V or 0.6 mA @ 20 mA output ranges).

Otherwise certain corrections need to be applied.

For example:

For entire range of process input, the Analog Output on 10 V FS scaled for **300 mV** output range:

$$\begin{aligned} \text{Rd1} &= 0000, & \text{Out1} &= 00.00 \\ \text{RD2} &= 9999, & \text{Out2} &= 00.30 \end{aligned}$$

The **measured output** will be as follows:

$$\begin{aligned} \text{Rd1} &= 0000, & \text{Out1} &= -0.07 \text{ V} \\ \text{Rd2} &= 9999, & \text{Out2} &= 0.23 \text{ V} \end{aligned}$$

This means that for 300 mV output range we have -70 mV offset at zero and at full scale. In order to compensate this 70 mV offset the **correct scaling** will be as follows:

$$\begin{aligned} \text{Rd1} &= 0000, & \text{Out1} &= 00.07 \\ \text{Rd2} &= 9999, & \text{Out2} &= 00.37 \end{aligned}$$

The above corrections need to be applied only for **Input scaled below 1% of FS** and **Output scaled below 3% of FS** or if you need the **Analog Output accuracy to be better than 1% of FS**.

3.2.8 Alarm 2

This unit is equipped with two physical outputs that can only be configured as follows: **Alarm 1 & Alarm 2, Alarm 1 & Output 2, Output 1 & Alarm 2, Output 1 & Output 2, Analog Out 1 & Alarm 2, Analog Out 1 & Output 2.** Analog Out available only if Analog Output Option board is factory installed.

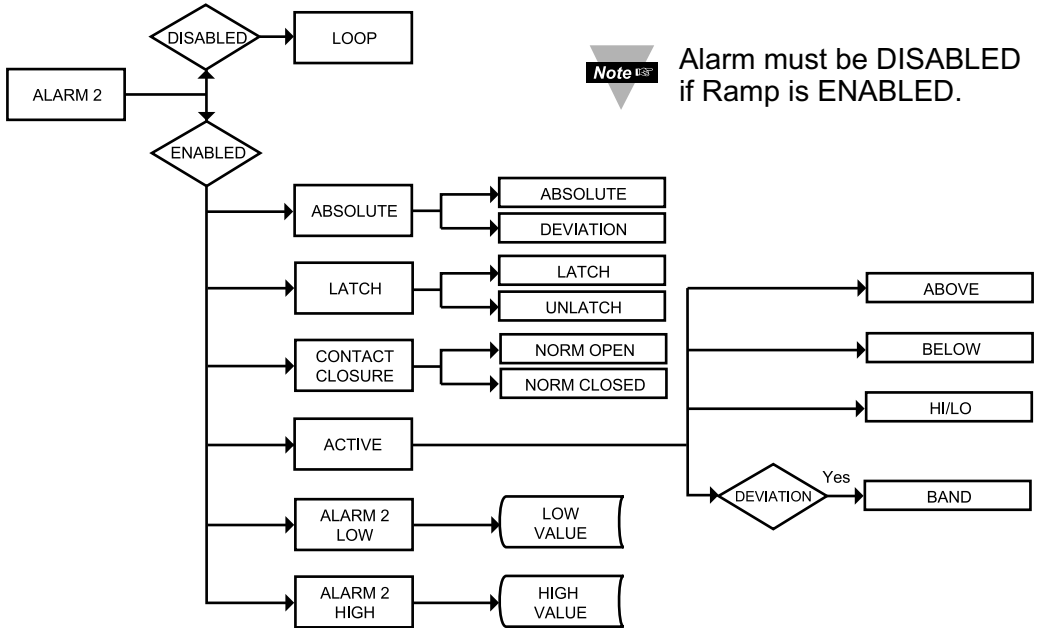

Note Alarm must be DISABLED if Ramp is ENABLED.

Figure 3.7 Flow Chart for Alarm 2

ENTER ALARM 2 MENU:

- Press **⏪** 1) Press **⏪**, if necessary, until **CONF** prompt appears.
- Press **⏩** 2) Display advances to **INPE** Input Menu.
- Press **⏪** 3) Press **⏪**, if necessary, until Display advances to **ALR2** Alarm 2 Menu.
- Press **⏩** 4) Display advances to Alarm 2 **ENBL** Enable or **dsbl** Disable Submenu.

ALARM 2 ENABLE/DISABLE SUBMENU:

- Press **⏪** 5) Display flashes previous selection. Press **⏩** until **ENBL** displays to use Alarm 2.
- Press **⏪** 6) Display shows **SEtPd** stored message momentarily and then advances to **AbSd** only if it was changed, otherwise press **⏪** to advance to **AbSd** Absolute/Deviation Submenu.

If **dSbL** Alarm 2 **Disabled** was selected, all submenus of Alarm 2 will be skipped and meter advances to **LOOP** Loop Break Time Menu. If **ENBL** Alarm 2 **Enabled** was selected, Output 2 will automatically **Disabled**, and reassigned as Alarm 2.

Note The remaining Alarm 2 menu items are identical to Alarm 1 Menu. Modifying Alarm Settings will not reset the instrument.

3.2.9 Loop Break Time

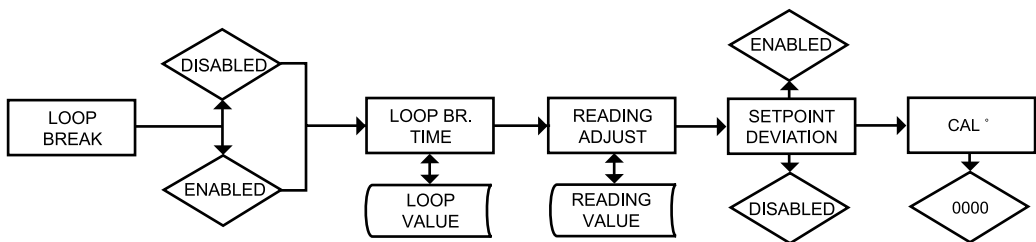

Figure 3.8 Flow Chart for Loop Break Time

ENTER LOOP BREAK TIME MENU:

- Press **⏪** 1) Press **⏪**, if necessary, until **ENFG** prompt appears.
- Press **⏪** 2) Display advances to **INPE** Input Menu.
- Press **⏪** 3) Press **⏪**, if necessary, until Display advances to **LOOP** Loop Break Time Menu.
- Press **⏪** 4) Display advances to Loop Break Time **ENBL** Enable or **dSbL** Disable Submenu and flashes the previous selection.

LOOP BREAK ENABLE/DISABLE SUBMENU:

- Press **⏩** 5) Scroll through the available selections: **ENBL** or **dSbL**.
- Press **⏪** 6) Display shows **SEtPd** stored message momentarily and then advances to **b.t.tM** Loop Break Time Value Submenu.

Loop Break is an additional safety feature intended to monitor the rate of change of the process value, while approaching the SP1. It is strictly intended as an additional warning system, therefore its use is entirely optional. An active Loop Break will cause the Process Value digits to blink in a rotating pattern. If the process value reaches the set point the blinking will stop and **b.t.tM** is completed successfully, otherwise **b.R.AL** Break Alarm warning will flash, and Output 1 will be turned off.

LOOP BREAK TIME VALUE SUBMENU:

- Press **↻** 7) Display flashes 1st digit of previous Loop Value.
- Press **▲** & **▼** 8) Press **▲** and **▼** buttons to enter a new Loop Value (0 to 99.59).
- Press **↻** 9) Display shows **SErD** stored message momentarily and then advances to **R.AdJ** Reading Adjust Submenu.

Loop Break Time Value allows the user to determine the time interval in MM:SS (from zero to 99 minutes and 59 seconds) that the Process Value changes at least 10 counts or if the Input Type is either RTD or Thermocouple, the value changes 4° Fahrenheit or 2° Celsius. At the specified time interval, if the process value change is less than the stated rate, flashing **b.t IM** will be displayed, the output 1 will be de-energized, and Alarm 1 energized. Loop break time will be disabled when the Process Value (PV) enters the control band.

C.J. READING ADJUST SUBMENU:

- Press **↻** 10) Display flashes 1st digit of previous reading adjust value.
- Press **▲** & **▼** 11) Press **▲** and **▼** buttons to enter a new Reading Adjust value (-1999 to 9999).
- Press **↻** 12) Display shows **SErD** stored message momentarily and then advances to **SP.dV** Setpoint Deviation Menu.

Reading Offset Adjust (C.J.) allow the user to fine tune a minor error of the transducer, however some applications may require a large offset adjust. (Displayed Process Value = Measured Process Value ± R.ADJ). R.ADJ is adjustable between -1999 to 9999.

SETPOINT DEVIATION ENABLE/DISABLE SUBMENU:

- Press **↻** 13) Display advances to Setpoint Deviation **ENbL** Enable or **dSbL** Disable Submenu and flashes the previous selection.
- Press **▲** 14) Scroll through the available selections: **ENbL** or **dSbL**.
- Press **↻** 15) Display shows **SErD** stored message momentarily and then advances to **CRl°** Menu.

Setpoint Deviation Submenu, if “enabled”, allows changes to Setpoint 1 to be made automatically to Setpoint 2. This mode is very helpful if the Process Value changes often. In Setpoint Deviation Mode, set SP2 a certain number of degrees or counts away from SP1 - this relation remains fixed when SP1 is changed. For instance: Setting SP1=200 and SP2=20 and enabling **SP.dV** means that the absolute value of SP2=220. Moving SP1 to 300, the absolute value of SP2 becomes 320.

THERMOCOUPLE FIELD CALIBRATION SUBMENU:



CAUTION: Do not perform the following steps until you fully understand this entire section.







RTD and Process are perfectly calibrated. This section is applicable to Thermocouple (TC) calibration *only*.

Be sure that the TC being used to calibrate the meter is of the type selected in the TC submenu. Place the TC in an ice-bath (or other **0°C / 32°F** environment). In ambient temperature conditions: connect the TC to the meter, apply power to the meter.



CAUTION: Do not proceed with TC calibration unless the above conditions have been in effect for at least one hour.

- Press  7) Display shows **CAL°**.
- Press  8) Display shows flashing **0000**.
- Press  * 9) Display will still show flashing **0000**.
- Press  * 10) Display shows **00E1** (meaning Calibration is complete)

* If you accidentally engage the flashing **0000** (CAL° alert) simply re-press the last button you pressed, to avoid unintentionally mis-calibrating your meter.

3.2.10 Output 1

Alarm 1 and Output 1 or Analog Output (Retransmission) share the same contacts on the rear panel connector. If Alarm 1 or Analog Output (Retransmission) is **Enabled**, Output 1 is automatically **Disabled**.

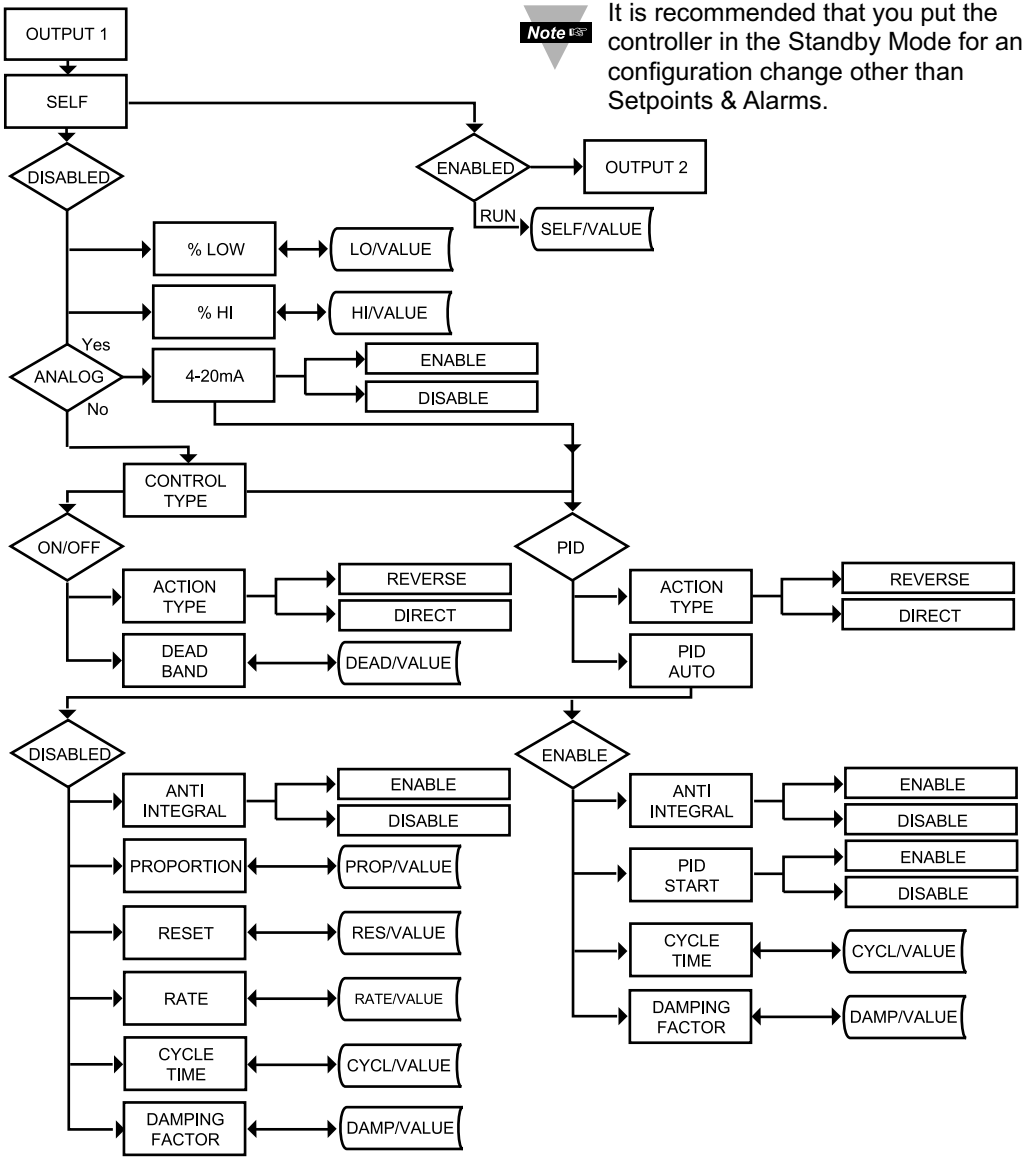

Figure 3.9 Flow Chart for Output 1

ENTER OUTPUT 1 MENU:

- Press **↻** 1) Press **↻**, if necessary, until **ENFG** prompt appears.
- Press **↻** 2) Display advances to **INPE** Input Menu.
- Press **↻** 3) Press **↻**, if necessary, until Display advances to **OUT 1** Output 1 Menu.
- Press **↻** 4) Display advances to **SELF** Self Submenu.

SELF SUBMENU:

The Self Option allows the output of the instrument to be controlled manually from the front panel.

- Press **↻** 5) Display flashes the current setting of Self, **ENBL** Enabled or **DSBL** Disabled.
- Press **▲** 6) Press the **▲** button to select between Enable and Disable.
- Press **↻** 7) If Self **ENBL** Enabled was selected, display shows **SErD** stored message momentarily and then advances to the next menu (Output 1 setting is completed).

The output is now under the direct control of the operator and can be adjusted in the Run Mode (**000.0** to **999.9**), by pressing the **▲** and **▼** buttons, where M calls for the Manual (Self) Control. For example, setting of **750.0** of an Analog Output of 0 to 10 Vdc would produce roughly 5 Vdc at the output.

- 8) If Self **DSBL** Disabled was selected, display shows **SErD** stored message momentarily and then advances to **0%LO** Minimum/Percent Low Submenu of Output 1 Menu.

Note

There is a shorter way to Enable or Disable Self Mode. From a Run Mode, press **↻** and then press **↻**. Self Mode is Enabled now. Press **▲** and **▼** to display **MXX.X**. To disable Self, press **↻** and then press **↻**. Display goes to the Run Mode. Self Mode is Disabled now.

MINIMUM/PERCENT LOW SUBMENU:

Specify in percent, the minimum value (0000) for control output. If the output is analog proportional (Current or Voltage), then the minimum voltage or current, in percent, is specified. If the output is time proportional (Relay, SSR or Pulse), then the minimum duty-cycle, in percent, is specified.

- Press **↻** 9) Display flashes 1st digit of previous "Percent Low" setting.
- Press **▲** & **▼** 10) Use **▲** and **▼** buttons to enter a new value for "Percent Low".
- Press **↻** 11) Display shows **SErD** stored message momentarily and then advances to **0%HI** Maximum/Percent High Submenu.

MAXIMUM/PERCENT HIGH SUBMENU:

Specify in percent, the maximum value (99) for control output. If the output is analog proportional (Current or Voltage), then the maximum voltage or current, in percent, is specified. If the output is time proportional (Relay, SSR, or Pulse), then the maximum duty-cycle, in percent, is specified.

- Press **⏪** 12) Display flashes 1st digit of previous "Percent High" setting.
- Press **⏩** & **⏪** 13) Use **⏩** and **⏪** buttons to enter a new value for "Percent High".
- Press **⏪** 14) Display shows **SEtRd** stored message momentarily and then advances to **CErL** Control Type Submenu.

Example: On an Analog Output of 0~10 Vdc, a setting of %LO = 10 and %HI = 90, cause the minimum on the control output to be 1 V and the maximum on the control output to be 9 V. The same setting on a time proportional output, will cause 10% duty cycle for the minimum control output and 90% duty cycle for maximum control output. To disable %LO/HI, set LO to 00 and HI to 99. If %LO/HI is at other values than the default (%LO = 00, %HI = 99), **SOARk** is disabled.

*CONTROL TYPE OUTPUT:

(Relay, SSR, Pulse or Analog)

- Press **⏪** 15) Display flashes **ON.OFF** On/Off or **PID** Proportional, Integral, Derivative.
- Press **⏩** 16) Scroll through the available selections: "ON/OFF" or "PID".
- Press **⏪** 17) Display flashes **SEtRd** stored message momentarily and then advances to **AcEN** only, if it was changed, otherwise press **⏩** to advance to **AcEN** Action Type Submenu.

The **ON/OFF** control is a coarse way of controlling the process. The "Dead Band" improves the cycling associated with the On/Off control. The **PID** control is best for processes where the Setpoint is continuously changing and/or a tight control of the process variable is required. PID control requires tuning and adjustment of the "Proportional", "Integral or Reset" and "Derivative or Rate" terms by a trial-and-error method. The instrument provides an "Auto Tuning" feature making the tuning process automatic, possibly optimum.





* If Analog Output (Current/Voltage) is your control Output 1, this menu i.e. **CErL** type will not appear, instead **4-20** Current will be displayed. Select **ENbL** for a 4-20 mA current (2-10 V Voltage) outputs or **05bL** for a 0-20 mA current (0-10 V Voltage) outputs. If 4-20 mA is enabled, %HI/LO setting will have no effect.



Both Current and Voltage control outputs are active simultaneously.

ACTION TYPE SUBMENU:





The error that results from the measurement of the Process Variable may be positive or negative since it may be greater or smaller than the Setpoint. If a positive error should cause the instrument output to increase (i.e. cooling), it would be called **Direct Acting**. If a negative error should cause the output to increase (i.e. heating), it would be called **Reverse Acting**.

- Press  18) Display flashes **DRCT** Direct or **RURS** Reverse.
- Press  19) Scroll through the available selections: "Direct" or "Reverse".
- Press  20) Display shows **SErD** stored message momentarily and then advances to **AUeD** only, if it was changed, otherwise press  to advance to **AUeD** Auto PID Submenu (if PID Control Type was selected).



If **"ON/OFF"** was selected in the Control Type, the display skips to the Dead Band Submenu.

AUTO PID SUBMENU:





- Press  21) Display flashes **ENbL** or **dSbL**.
- Press  22) Scroll through the available selections: "Enable" or "Disable".
- Press  23) Display shows **SErD** stored message momentarily and then advances to **ANeL** only, if it was changed, otherwise press  to advance to **ANeL** Anti Integral Submenu.



If **"Enabled"**, the controller can determine, by enabling Start PID, the optimum values for the three adjustments — Proportional, Reset and Rate corresponding to P, I, and D. These values may be changed once the auto tuning is complete.

If **"Disabled"** is selected, the user will manually enter these three adjustment values. If you want the instrument to do the auto PID and the P, PI or PID, first select auto disable and enter 0000 for unwanted parameter. i.e. for PI enter 0000 for the rate.

ANTI INTEGRAL SUBMENU:

- Press  24) Display flashes **ENbL** or **dSbL**.
- Press  25) Scroll through the available selections: "Enable" or "Disable".
- Press  26) Display shows **SErD** stored message momentarily and then advances to **SErE** only, if it was changed, otherwise press  to advance to **SErE** to Start Auto Tune PID Submenu (If auto PID was Enabled).



If Auto PID was disabled display advances to **PRoP** Proportional Band Submenu.

Note

If Anti Integral (Anti Windup) Submenu “**Enabled**”, this feature allows the error term outside the proportional band to be calculated and accumulated for integration. This may be an important feature in applications where fast response time is desirable.

START AUTO TUNE PID:

- Press **↻** 27) Display flashes **ENBL** or **DSBL**.
- Press **▲** 28) Scroll through the available selections: “Enable” or “Disable”.
- Press **↻** 29) Display shows **SEPRd** stored message momentarily and then advances to **CYCL** only, if it was changed, otherwise press **↻** to advance to **CYCL** Cycle Time Submenu.

Note

If “**Enabled**”, the controller is ready to calculate P, PI or PID parameters. The instrument performs this by activating the output and observing the delay and rate at which the Process Value changes. The setpoints must be at least 18°F or 10°C above the (PV) Process Value in order to perform Auto Tune, otherwise an error message will be displayed.

To start Auto Tune PID select PID, enable Auto PID and enable Start PID. Sometimes Auto PID parameter needs fine tuning i.e. for each 5°F over shoot increase the Proportional Band (PB) by 15% and for each ±1°F fluctuation at the Setpoint (SP) increase reset by 20%.

Once started, display shows **A.TUN** with letters blinking in the rotating pattern. When auto tune stops, display will show process value. Do not perform any operations or settings before first stopping Auto Tune. Any alarms or other output is disabled during Auto Tune.

Note

If “**AUTO PID**” was “**DISABLED**”, the display will show the following three submenus. This allows the user to manually enter values for Proportional, Reset and Rate terms corresponding to P, I, and D. It also can be used for auto PID for disabling unwanted parameter i.e. PI enter 0000 for rate.

PROPORTIONAL BAND SUBMENU:

- Press **↻** 30) Display flashes 1st digit of the previous **P PRoP** Proportional band value.
- Press **▲** & **▼** 31) Press **▲** and **▼** buttons to enter a new “Proportional Band” value.
- Press **↻** 32) Display shows **SEPRd** stored message momentarily and then advances to **RESL** only, if it was changed, otherwise press **↻** to advance to **RESL** Reset Setup Submenu.

Proportional band is in degrees of temperature or counts of process. Proportional band is defined, as the change in the instrument input to cause a 100% change in the controller output.

RESET SETUP SUBMENU:

- Press **↻** 33) Display flashes 1st digit of the previous **RESET** Reset value.
- Press **▲** & **▼** 34) Press **▲** and **▼** buttons to enter a new “Reset” value.
- Press **↻** 35) Display shows **SErD** stored message momentarily and then advances to **RATE** only, if it was changed, otherwise press **↻** to advance to **RATE** Rate Setup Submenu.

Reset unit is in seconds 0-3999.

RATE SETUP SUBMENU:

- Press **↻** 36) Display flashes 1st digit of previous **RATE** Rate value.
- Press **▲** & **▼** 37) Press **▲** and **▼** buttons to enter a new **RATE** value.
- Press **↻** 38) Display shows **SErD** stored message momentarily and then advances to the **CYCL** only, if it was changed, otherwise press **↻** to advance to **CYCL** Cycle Time submenu for RTD and Thermocouple types.

Rate unit is in seconds 000.0-399.9.







If the Output 1 is Analog Option the display skips to Damping Factor.

CYCLE TIME SUBMENU:

- Press **↻** 39) Display flashes 1st digit of the previous **CYCL** Cycle Time value.
- Press **▲** & **▼** 40) Press **▲** and **▼** buttons to enter a new “Cycle Time” value. (1 to 199 seconds)
- Press **↻** 41) Display shows **SErD** stored message momentarily and then advances to **DPNG** only, if it was changed, otherwise press **↻** to advance to **DPNG** Damping Factor Submenu.

A Cycle Time selected between 1 and 199 seconds determines the total On/Off time of each proportional cycle. For example, a 15 second cycle time means that every 15 seconds the output will turn on for part or all of the cycle. For Relay control outputs, do not select a cycle time of less than 7 seconds or the relays' lifetime will be shortened. For a cycle time of less than 7 seconds select SSR or DC pulse. Use an external SSR with the DC pulse option for higher currents (higher than 1 Amp).

DAMPING FACTOR SUBMENU:







- Press  42) Display flashes the previous "Damping Factor" selection.
- Press  43) Scroll through the available selections: **0000**, **0001**, **0002**, **0003**, **0004**, **0005**, **0006**, **0007**.
- Press  44) Display flashes **SEtRd** stored message and then advances to **OUT2** only, if it was changed, otherwise press  to advance to **OUT2** Output 2 Menu.

Damping Factor is a measure of speed, overshoot, and undershoot in which the process variable responds to the output changes of the instrument, which were used during the Auto Tune. This value is typically set to the ratio of Rate to Reset. This Default value is (0003). For fast response time, this value should be decreased while for slow response time it should be increased.



The "DEADBAND" Submenu will only appear if "ON/OFF" was selected from the "Control Type" Menu.

DEADBAND SUBMENU:

- Press  45) Display flashes 1st digit of the previous **DEAd** Deadband value.
- Press  &  46) Press  and  buttons to enter a new "Deadband" value.
- Press  47) Display shows **SEtRd** stored message and then advances to **OUT2** only, if it was changed, otherwise press  to advance to **OUT2** Output 2 Menu.

Dead Band units are the same as Proportional Band units.



The Dead Band or neutral zone is the number of degrees or counts (if Input Type is Process) around the Setpoint which the Process Variable must pass above or below the Setpoint, before the output changes state.

3.2.11 Output 2

Output 2 and Alarm 2 share the same contacts on the rear panel connector. If Alarm 2 is **Enabled**, Output 2 is automatically **Disabled**.

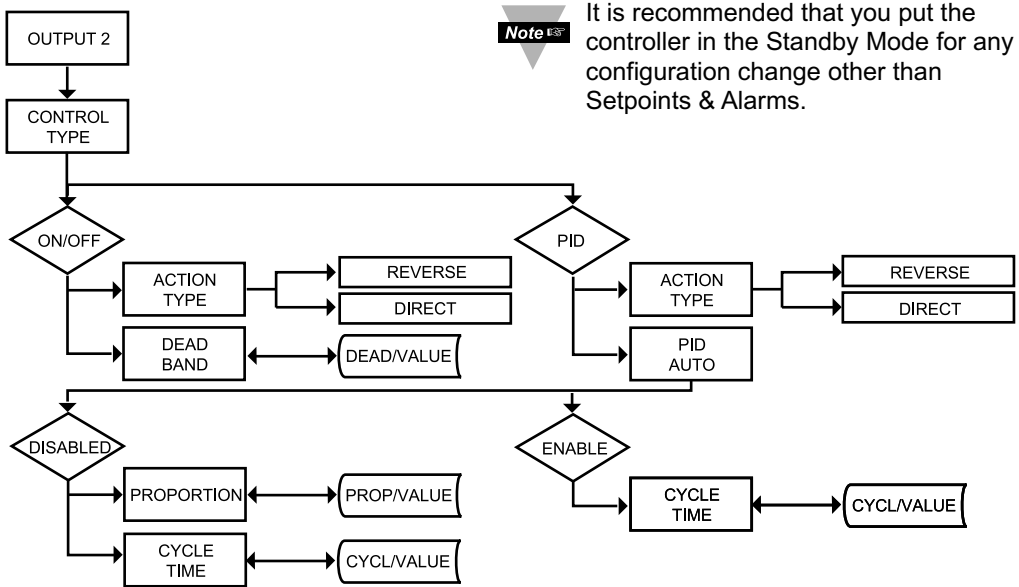

Figure 3.10 Flow Chart for Output 2

ENTER OUTPUT 2 MENU:

- Press **⏏** 1) Press **⏏**, if necessary, until **CNFG** prompt appears.
- Press **⏏** 2) Display advances to **INPE** Input Menu.
- Press **⏏** 3) Press **⏏**, if necessary, until Display advances to **OUT2** Output 2 Menu.
- Press **⏏** 4) Display advances to **CTRL** Control Type Submenu.





CONTROL TYPE SUBMENU:

- Press **⏏** 3) Display flashes **ON.OFF** ON/OFF, or **PID** PID.
- Press **⏏** 4) Scroll through the available selections: "ON/OFF" or "PID".
- Press **⏏** 5) Display shows **STRT** stored message momentarily and then advances to **ACTEN** only, if it was changed, otherwise press **⏏** to advance to **ACTEN** Action Type Submenu.

The ON/OFF control is a coarse way of controlling the Process. The "Dead Band" improves the cycling associated with the ON/Off control. The PID control is best for processes where the Setpoint is continuously changing and/or tight control of the Process Variable is required.

ACTION TYPE SUBMENU:

The error that results from the measurement of the Process Variable may be positive or negative since it may be greater or smaller than the Setpoint. If a positive error should cause the instrument output to increase (i.e. cooling), it would be called **Direct Acting**. If a negative error should cause the output to decrease (i.e. heating), it would be called **Reverse Acting**.

- Press  6) Display flashes **DRCT** Direct or **RVRSE** Reverse.
- Press  7) Scroll through the available selections: "Direct" or "Reverse".
- Press  8) Display shows **STRTd** stored message momentarily and then advances to **AUTO** only, if it was changed, otherwise press  to advance to **AUTO** Auto PID Submenu (If PID Control type was selected).

Note 



If ON/OFF was selected in the Control Type, the display skips to the Dead Band Submenu.

AUTO PID SUBMENU:

- Press  9) Display flashes **ENBL** Enable or **DSBL** Disable.
- Press  10) Scroll through the available selections: "Enable" or "Disable".

Note 

If "Enabled", the PID parameter of Output 1 will be copied to Output 2.







- Press  11) Display shows **STRTd** stored message momentarily and then advances to the next submenu only, if it was changed, otherwise press  to advance to the next submenu.

Note 

If AUTO PID was "ENABLED", the display skips to the **CYCL** CYCLE TIME submenu. If "AUTO PID" was "DISABLED", the display will show **PROP** PROPORTIONAL BAND Submenu allowing the user to manually enter the Proportional Band value.

The Reset and Rate value are the same as Output 1.







PROPORTIONAL BAND SUBMENU:

- Press  12) Display flashes 1st digit of the previous Proportional Band value.
- Press  &  13) Press  and  buttons to enter a new Proportional Band value.
- Press  14) Display shows **STRTd** stored message momentarily and then advances to **CYCL** only, if it was changed, otherwise press  to advance to the **CYCL** Cycle Time Submenu.

Note 

Refer to "Proportional Band" Submenu of "Output 1" Menu.







CYCLE TIME SUBMENU:

- Press  15) Display flashes 1st digit of the previous "Cycle Time" value.
- Press  &  16) Press  and  buttons to enter a new "Cycle Time" value (1 to 199 seconds).
- Press  17) Display shows **SEtPd** stored message momentarily and then advances to **RAMP** only, if it was changed, otherwise press  to advance to **RAMP** Ramp Value Submenu.

A cycle time selected between 1 to 199 seconds indicates the total On/Off time of each proportional cycle. For example, a 15 second cycle time means that every 15 seconds the output will turn on for part or all of the cycle. For Relays' Control Outputs, do not select a cycle time of less than 7 seconds or the relays' lifetime will be shortened. For a cycle time of less than 7 seconds select SSR or DC pulse. Use an external SSR with the DC pulse option for higher current (higher than 1 Amp).

The DEADBAND Submenu will only appear if the ON/OFF was selected from the "Control Type" Submenu.

DEADBAND SUBMENU:

- Press  18) Display flashes 1st digit of the previous "Dead Band" value.
- Press  &  19) Press  and  buttons to enter a new "Dead Band" value.
- Press  20) Display shows **SEtPd** stored message momentarily and then advances to **RAMP** only, if it was changed, otherwise press  to advance to **RAMP** Ramp Value Menu.

Dead Band units are the same as Proportional Band units.



The Dead Band is the number of degrees or counts around the Setpoint which the Process Variable must pass through before the output changes state.

3.2.12 Ramp & Soak

Note ^{ES}

It is recommended that you put the controller in the Standby Mode for any configuration change other than Setpoints & Alarms.

Note ^{ES}

Alarm must be DISABLED if Ramp is ENABLED.

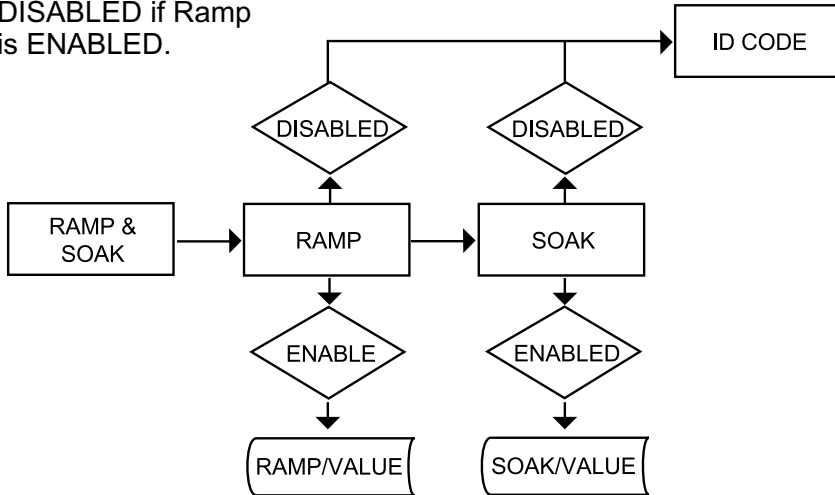

Figure 3.11 Flow Chart for Ramp and Soak

ENTER RAMP AND SOAK MENU:

- Press **⏻** 1) Press **⏻**, if necessary, until **ENFG** prompt appears.
- Press **⏻** 2) Display advances to **INPE** Input Menu.
- Press **⏻** 3) Press **⏻**, if necessary, until Display advances to **RAMP** Ramp and **SOAK** Soak Menu.

RAMP ENABLE/DISABLE SUBMENU:

- Press **⏻** 4) Display advances to “Ramp Enable/Disable” Submenu and flashes **ENbL** or **DSbL**.
- Press **⏴** 5) Scroll through the available selections: “Enable” or “Disable”.
- Press **⏻** 6) Display shows **SEEd** stored message momentarily and then advances to **SOAK** Soak Enable/Disable Menu.

Note ^{ES}

If **RAMP Disable** was selected, display skips to the next menu item (ID Code).

SOAK ENABLE/DISABLE SUBMENU:

- Press **⏻** 7) Display flashes **ENbL** or **DSbL**.
- Press **⏴** 8) Scroll through the available selections: “Enable” or “Disable”.
- Press **⏻** 9) Display shows **SEEd** stored message momentarily and then advances to “Ramp Value” Submenu.

Ramp & Soak provides users with the flexibility to slowly bring the Process Variable (PV) to the desired setpoint. Ramp & Soak values are specified in HH.MM format. The Ramp value indicates the time specified to bring the process variable to Setpoint 1 (SP1). Once the set point is reached, the PID takes over and the Process Variable will be controlled at the desired set point indefinitely. If Soak is enabled, PID will control the Process Variable at the specified Setpoint for the duration of Soak time and then will turn off Output 1. To start a new Ramp/Soak cycle, reset the instrument by pressing **↻** and then **⏏** button.

An active Ramp/Soak will change SP1 one degree above the PV and will cause the most significant digit to blink. The SP1 will be incremented by one degree until it reaches the original SP1. The minimum Ramp time must be at least twice the time that it will take the PV to reach the Setpoint Value (SV) with OUT 1 fully ON.

RAMP VALUE SUBMENU:

- Press **↻** 10) Display flashes 1st digit of previous stored "Ramp Value".
- Press **▲** & **▼** 11) Press **▲** and **▼** buttons to enter a new "Ramp Value".
- Press **↻** 12) Display shows **SEtPd** stored message momentarily and then advances to "Soak Value" Submenu.

SOAK VALUE SUBMENU:

- Press **↻** 13) Display flashes 1st digit of previous stored "Soak Value".
- Press **▲** & **▼** 14) Press **▲** and **▼** buttons to enter a new "Soak Value".
- Press **↻** 15) Display shows **SEtPd** stored message and advances to the **Id** ID Code Menu.

The Ramp and Soak time is 00:00 to 99:59 i.e. HH.MM. (from zero to 99 hours and 59 minutes) During Ramp & Soak do not perform any operations or settings before first stopping it. Any alarms or other output are disabled during this time. To stop Ramp & Soak first put instrument into Standby Mode, then go to Ramp & Soak Menu and disable it.

3.2.13 ID CODE

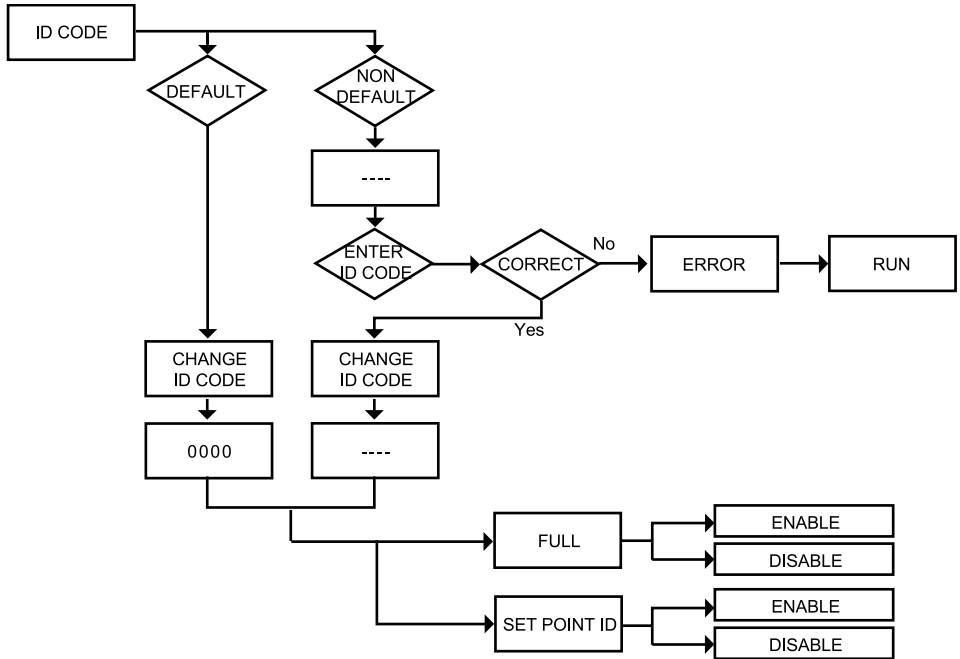

Figure 3.12 Flow Chart for ID Code

ENTER ID CODE MENU:

- Press 1) Press , if necessary, until **CHFD** prompt appears.
- Press 2) Display advances to **INPE** Input Menu.
- Press 3) Press , if necessary, until Display advances to **Id** ID Code Menu.

ENTERING OR CHANGING YOUR (NON-DEFAULT) ID CODE:

- Press 4) Display advances to **----** with 1st under score flashing.
- Press & 5) Press and to enter your 4-digit "ID Code" number.
- Press 6) Display advances to **CH. Id** Change ID Code Submenu.



If entered "ID Code" is incorrect display shows **ERR** Error message momentarily and then skips to the Run Mode.

- Press 7) Display flashes the first digit of previous entered "ID Code" number.
- Press & 8) Press and buttons to enter your new "ID Code" number.
- Press 9) Display shows **STRD** stored message momentarily and then advances to the **FULL** Full Security Submenu.

ENTERING OR CHANGING YOUR (DEFAULT) ID CODE:

Enter **ID** menu (Repeat steps from 1 to 3).

- Press  10) Display advances to **CH.ID** Change ID Code Submenu.
Press  11) Display shows **0000** message with flashing 1st digit.

Note 

If you want to change your default "ID Code" you can do it now, otherwise press  and menu will skip to **FULL** Full Security Submenu.

- Press  &  12) Press  and  buttons to enter your new "ID Code" number.
Press  13) Display shows **SETRd** stored message momentarily and then advances to the **FULL** Full Security Submenu.

FULL SECURITY LEVEL SUBMENU:

- Press  14) Display flashes **ENbL** Enable or **DSbL** Disable.
Press  15) Scroll through the available selections: "Enable" or "Disable".
Press  16) Display shows **SETRd** stored message momentarily and then advances to **SP.ID** Setpoint/ID Submenu.

Note 

If "Full" Security Level is "Enabled" and the user attempts to enter the Main Menu, they will be prompted for an ID Code. The ID Code should be correct to enter the instrument Menu item.

SETPOINT/ID SECURITY LEVEL SUBMENU:

Note 

This Security Level can be functional only if **FULL** Security Level is Disabled.

- Press  17) Display flashes **ENbL** Enable or **DSbL** Disable.
Press  18) Scroll through the available selections: "Enable" or "Disable".
Press  19) Display shows **SETRd** stored message momentarily and then advances to **COMM** Communication Submenu.

Note 

If "**Setpoint/ID**" Security Level is "**Enabled**" and the user attempts to advance into the **CONF** Configuration Menu, he will be prompted for ID Code number. The ID Code should be correct to proceed into the Configuration Menu, otherwise display will show an Error and skip to the Run Mode.

Note 

If "**Full**" and "**Setpoint/ID**" Security Levels are "**Disabled**", the ID code will be "Disabled" and user will not be asked for ID Code to enter the Menu items ("ID" Submenu will not show up in "ID/Setpoint" Menu).

3.2.14 COMMUNICATION OPTION

Purchasing the controller with Serial Communications permits an instrument to be configured or monitored from an IBM PC compatible computer using software available from **the website or on the CD-ROM enclosed with your shipment**. For complete instructions on the use of the Communications Option, refer to the Serial Communications Reference Manual.

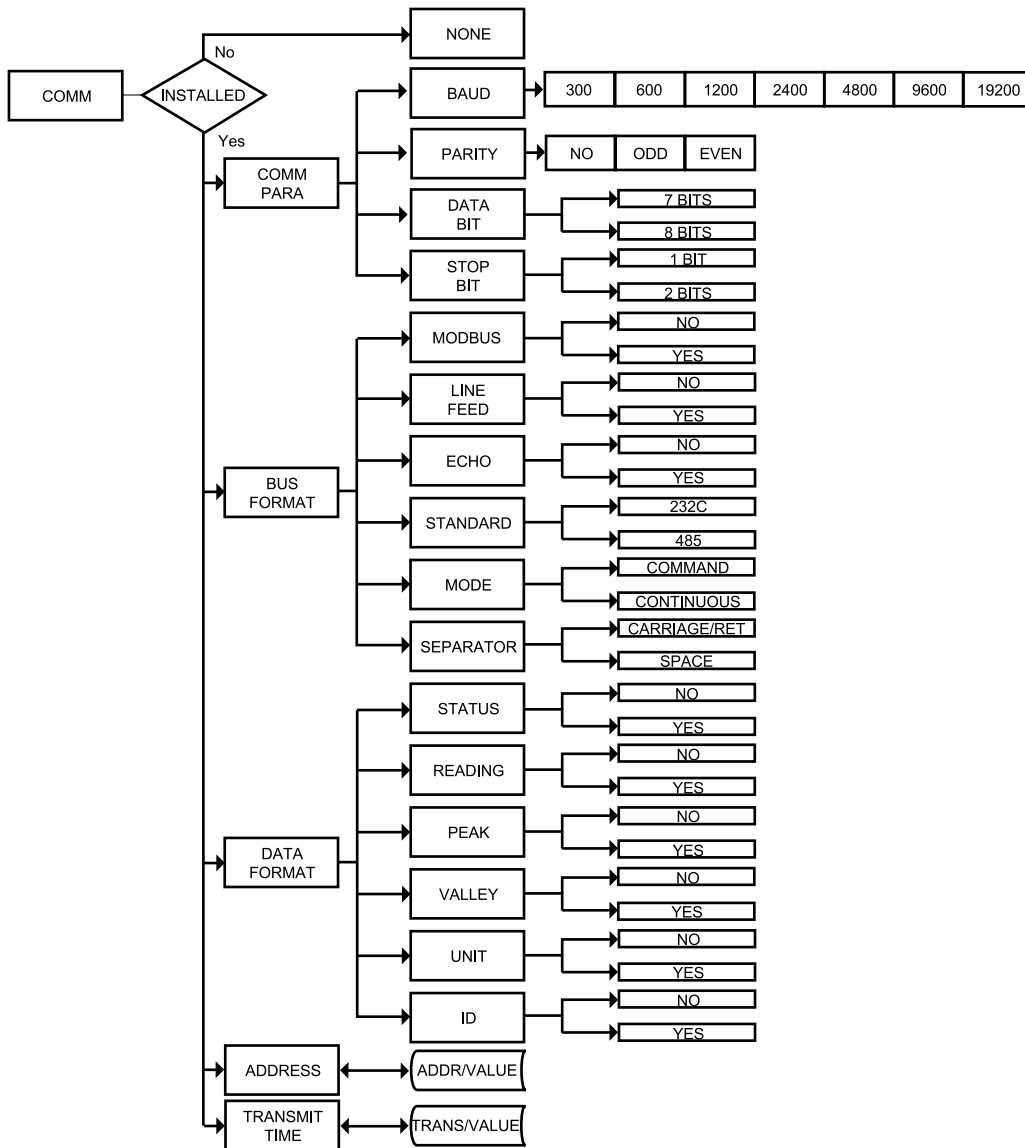







Figure 3.13 Flow Chart for Communication Option

ENTER COMMUNICATION OPTION MENU:

- Press  1) Press , if necessary, until **ENFC** prompt appears.
- Press  2) Display advances to **INPE** Input Menu.
- Press  3) Press , if necessary, until Display advances to **COMM** Communication Options Menu.
- Press  4) Display advances to **CPAR** Communication Parameters Submenu.







If Communication Option is not installed, the display shows **NONE** and skips to the Color Display Menu.

COMMUNICATION PARAMETERS SUBMENU:





Allows the user to adjust Serial Communications Settings of the instrument. When connecting an instrument to a computer or other device, the Communications Parameters must match. Generally the default settings (as shown in Section 5) should be utilized.

- Press  5) Display advances to **BAUD** Baud Submenu.





BAUD SUBMENU:

- Press  6) Display flashes previous selection for **BAUD** value.
- Press  7) Scroll through the available selections: **300**, **600**, **1200**, **2400**, **4800**, **9600**, **19.2K**.
- Press  8) Display shows **SEED** stored message momentarily and then advances to **PREY** only, if it was changed, otherwise press  to advance to **PREY** Parity Submenu.





PARITY SUBMENU:

- Press  9) Display flashes previous selection for "Parity".
- Press  10) Scroll through the available selections: NO, ODD, EVEN.
- Press  11) Display shows **SEED** stored message momentarily and then advances to **DATA** only, if it was changed, otherwise press  to advance to **DATA** Data Bit Submenu.

DATA BIT SUBMENU:

- Press  12) Display flashes previous selection for "Data Bit".
- Press  13) Scroll through the available selections: 7-BIT, 8-BIT.
- Press  14) Display shows **SEED** stored message and then advances to **STOP** only, if it was changed, otherwise press  to advance to **STOP** Stop Bit Submenu.

STOP BIT SUBMENU:





- Press  15) Display flashes previous selection for “Stop Bit”.
- Press  16) Scroll through the available selections: 1-BIT, 2-BIT.
- Press  17) Display shows **SErD** stored message momentarily and then advances to **bUS.F** only, if it was changed, otherwise press  to advance to **bUS.F** Bus Format Submenu.

BUS FORMAT SUBMENU:

Determines Communications Standards and Command/Data Formats for transferring information into and out of the controller via the Serial Communications Bus. Bus Format submenus essentially determine how and when data can be accessed via the Serial Communications of the device.

- Press  18) Display advances to **m.bUS** Modbus Submenu.

MODBUS PROTOCOL SUBMENU:





- Press  19) Display flashes previous selection for **m.bUS**.
- Press  20) Scroll through the available selections: NO, YES.
- Press  21) Display shows **SErD** stored message momentarily and then advances to **-LF-** only, if it was changed, otherwise press  to advance to **-LF-** Line Feed submenu.

 **Note** To select iSeries Protocol, set Modbus submenu to “No”.
To select Modbus Protocol, set Modbus submenu to “Yes”.

 **Note** If Modbus Protocol was selected, the following Communications Parameters must be set as: No Parity, 8-bit Data Bit, 1-Stop Bit. Do not attempt to change these parameters.

LINE FEED SUBMENU:

Determines if data sent from the instrument will have a Line Feed appended to the end - useful for viewing or logging results on separate lines when displayed on communications software at a computer.

- Press  22) Display flashes previous selection for “Line Feed”.
- Press  23) Scroll through the available selections: NO, YES.
- Press  24) Display shows **SErD** stored message momentarily and then advances to **ECHO** only, if it was changed, otherwise press  to advance to **ECHO** Echo Submenu.

ECHO SUBMENU:

When valid commands are sent to the instrument, this determines whether the command will be echoed to the Serial Bus. Use of echo is recommended in most situations, especially to help verify that data was received and recognized by the controller.

- Press **↻** 25) Display flashes previous selection for “Echo”.
- Press **▲** 26) Scroll through the available selections: NO, YES.
- Press **↻** 27) Display flashes **SEtRd** stored message momentarily and then advances to **SEtNd** only if it was changed, otherwise press **↻** to advance to **SEtNd** Communication Standard Submenu.

COMMUNICATION INTERFACE STANDARD SUBMENU:

Determines whether device should be connected to an RS-232C serial port (as is commonly used on IBM PC-compatible computers) or via an RS-485 bus connected through appropriate RS-232/485 converter. When used in RS-485 Mode, the device must be accessed with an appropriate Address Value as selected in the Address Submenu described later.

- Press **↻** 28) Display flashes previous selection for “Standard”.
- Press **▲** 29) Scroll through the available selections: 232C, 485.
- Press **↻** 30) Display shows **SEtRd** stored message momentarily and then advances to **MoDE** only, if it was changed, otherwise press **↻** to advance to **MoDE** Data Flow Mode Submenu.

DATA FLOW MODE SUBMENU:

Determines whether the instrument will wait for commands and data requests from the Serial Bus or whether the instrument will send data automatically and continuously to the Serial Bus. Devices configured for the RS-485 Communications Standard operate properly only under Command Mode.

- Press **↻** 31) Display flashes previous selection for “Mode”.
- Press **▲** 32) Scroll through the available selections: **Cmd** “Command”, **Cont** “Continuous”.
- Press **↻** 33) Display shows **SEtRd** stored message momentarily and then advances to **SEPR** only, if it was changed, otherwise press **↻** to advance to **SEPR** Data Separation Submenu.

DATA SEPARATION CHARACTER SUBMENU:

Determines whether data sent from the device in Continuous Data Flow Mode will be separated by spaces or by Carriage Returns.

- Press **↻** 34) Display flashes previous selection for “Separation” Submenu.
- Press **▲** 35) Scroll through the available selections: **SPCE** “Space” or **CR** “Carriage Return”.
- Press **↻** 36) Display shows **SEtRd** stored message momentarily and then advances to **DAt.F** only, if it was changed, otherwise press **↻** to advance to **DAt.F** Data Format Submenu.

DATA FORMAT SUBMENU:

Preformatted data can be sent automatically or upon request from the controller. Use the Data Format Submenus to determine what data will be sent in this preformatted data string. Refer to the iSeries Communications Manual for more information about the data format. At least one of the following suboptions must be enabled and hence output data to the Serial Bus.

Note This menu is applicable for Continuous Mode of RS-232 communication.

Press **⏪** 37) Display advances to **SETE** Alarm Status Submenu.

ALARM STATUS SUBMENU:

Includes Alarm Status bytes in the data string.

Press **⏪** 38) Display flashes previous selection for “Status” (alarm status).
Press **⏩** 39) Scroll through the available selections: NO, YES.
Press **⏪** 40) Display shows **SETR** stored message momentarily and then advances to **RJNG** only, if it was changed, otherwise press **⏪** to advance to **RJNG** Reading Submenu.

MAIN READING SUBMENU:

Includes Main Reading in the data string.

Press **⏪** 41) Display flashes previous selection for “Reading”.
Press **⏩** 42) Scroll through the available selections: NO, YES.
Press **⏪** 43) Display shows **SETR** stored message momentarily and then advances to **PEAK** only, if it was changed, otherwise press **⏪** to advance to **PEAK** Peak Submenu.

PEAK VALUE SUBMENU:

Includes Peak Value in the data string.

Press **⏪** 44) Display flashes previous selection for **PEAK** Submenu.
Press **⏩** 45) Scroll through the available selections: NO, YES.
Press **⏪** 46) Display shows **SETR** stored message momentarily and then advances to **VALY** only, if it was changed, otherwise press **⏪** to advance to **VALY** Valley Submenu.





VALLEY VALUE SUBMENU:

Includes Valley Value in the data string.

Press **⏪** 47) Display flashes previous selection for “Valley”.
Press **⏩** 48) Scroll through the available selections: NO, YES.
Press **⏪** 49) Display shows **SETR** stored message momentarily and then advances to **UNTE** only, if it was changed, otherwise press **⏪** to advance to **UNTE** Temperature Unit Submenu.

TEMPERATURE UNIT SUBMENU:

Includes a byte in the data string to indicate whether reading is in Celsius or Fahrenheit.







- Press  50) Display flashes previous selection for **UNIT**.
- Press  51) Scroll through the available selections: NO, YES.
- Press  52) Display shows **SEEd** stored message momentarily and then advances to **Addr** only, if it was changed, otherwise press  to advance to **Addr** Address Setup Submenu.

ADDRESS SETUP SUBMENU:

 **Note** This menu is applicable to the RS-485 Option only.

- Press  53) Display advances to “Address Value” (0000 to 0199) Submenu.

ADDRESS VALUE SUBMENU:

- Press  54) Display flashes 1st digit of previously stored Address Value.
- Press  &  55) Press  and  to enter new “Address Value”.
- Press  56) Display shows **SEEd** stored message momentarily and then advances to **EREM** only, if it was changed, otherwise press  to advance to **EREM** Transmit Time Interval Submenu.







TRANSMIT TIME INTERVAL SUBMENU:

 **Note** This menu is applicable if “Continuous” Mode was selected in the “Data Flow Mode” Submenu and the device is configured as an RS-232C Standard device. Also, one or more options under the Data Format Submenu must be enabled.

- Press  57) Display advances to “Transmit Time Value” Submenu.

TRANSMIT TIME INTERVAL VALUE SUBMENU:

Determines the interval at which data will be emitted to the RS-232 Serial Bus when the instrument is in Continuous Data Flow Mode.

- Press  58) Display flashes 1st digit of previous “Transmit Time Value” in seconds.
- Press  &  59) Press  and  to enter new “Transmit Time Value”, e.g. 0030 will send the data every 30 seconds in Continuous Mode.
- Press  60) Display shows **SEEd** stored message momentarily and then advances to **COLR** only, if it was changed, otherwise press  to advance to **COLR** Color Display Selection Menu.

 **Note** For more details, refer to the **Communication Manual** available at the website listed in the cover page of this manual or on the CD-ROM enclosed with your shipment.

3.2.15 DISPLAY COLOR SELECTION

This submenu allows the user to select the color of the display.

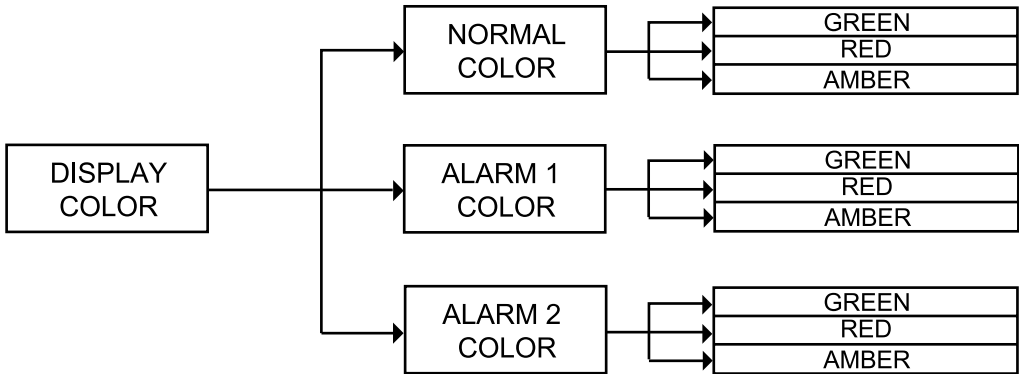

Figure 3.14 Flow Chart for Display Color Selection

ENTER DISPLAY COLOR SELECTION MENU:

- Press **⏪** 1) Press **⏪**, if necessary, until **ENFG** prompt appears.
- Press **⏩** 2) Display advances to **INPE** Input Menu.
- Press **⏪** 3) Press **⏪**, if necessary, until Display advances to **COLR** Display Color Selection Menu.
- Press **⏩** 4) Display advances to **N.CLR** Normal Color Submenu.

NORMAL COLOR DISPLAY SUBMENU:

- Press **⏩** 5) Display flashes the previous selection for “Normal Color”.
- Press **⏮** 6) Scroll through the available selections: **GRN**, **RED** or **AMBR**.
- Press **⏩** 7) Display shows **SEEd** stored message momentarily and then advances to **1.CLR** only, if it was changed, otherwise press **⏩** to advance to **1.CLR** Alarm 1 Display Color Submenu.

The menu below allows the user to change the color of display when alarm is triggered.

ALARM 1 DISPLAY COLOR SUBMENU:

- Press **⏩** 8) Display flashes previous selection for “Alarm 1 Color Display”.
- Press **⏮** 9) Scroll through the available selections: **GRN**, **RED** or **AMBR**.
- Press **⏩** 10) Display shows **SEEd** stored message momentarily and then advances to **2.CLR** only, if it was changed, otherwise press **⏩** to advance to **2.CLR** Alarm 2 Display Color Submenu.

ALARM 2 DISPLAY COLOR SUBMENU:

- Press **⏵** 11) Display flashes previous selection for "Alarm 2 Color Display".
 Press **⏴** 12) Scroll through the available selections: **GRN**, **RED** or **AMBR**.
 Press **⏵** 13) Display shows **SEt** stored message momentarily and then momentarily shows the software version number, followed by **RSt** Reset, and then proceeds to the Run Mode.

Tip IN ORDER TO DISPLAY ONE COLOR, SET THE SAME DISPLAY COLOR ON ALL THREE SUBMENUS ABOVE.

Note If user wants the Display to change color every time when both Alarm 1 and Alarm 2 are triggered, the Alarm values should be set in such a way that Alarm 1 value is always on the top of Alarm 2 value, otherwise value of Alarm 1 will overwrite value of Alarm 2 and Display Color would not change when Alarm 2 is triggered.

Example 1:

Output 1 & Output 2 = SSR

Alarm Setup: Absolute, Above, Alarm 2 HI Value "ALR.H" = 200, Alarm 1 HI Value "ALR.H" = 400

"Color Display" Setup: Normal Color "N.CLR" = Green, Alarm 1 Color "1.CLR" = Amber, Alarm 2 Color "2.CLR" = Red

Display Colors change sequences:



Example 2:

Output 1 & Output 2 = Pulse

Alarm Setup: Absolute, Below, Alarm 2 Low Value "ALR.L" = 300, Alarm 1 Low Value "ALR.L" = 100

Color Display Setup: "N.CLR" = Green, "1.CLR" = Amber, "2.CLR" = Red

Display Colors change sequences:

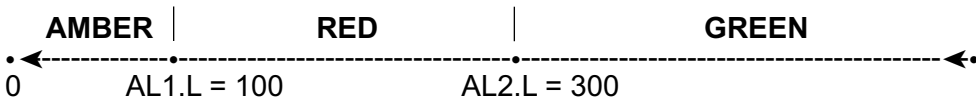

Example 3:

Output 1 = Analog Output (Alarm 1 disabled), Setpoint 1 = 300,

Output 2 = Relay, Setpoint 2 = 200

Alarm 1 & 2 Setup: Deviation, Band, "ALR.H" = 10

Color Display Setup: "N.CLR" = Green, "1.CLR" = Amber, "2.CLR" = Red

Display Colors change sequences:

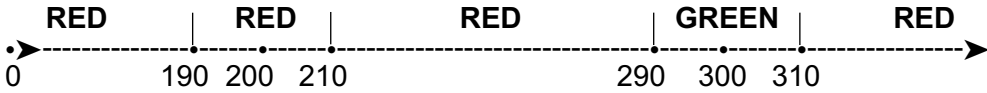

Tip

Alarm 1 is designed to monitor the Process Value around the Setpoint 1.
Alarm 2 is designed to monitor the Process Value around the Setpoint 2.
If Analog Output Option board is installed (Alarm 1 is disabled), only Alarm 2 is active and only two colors are available.

Example 4:

Output 1 = Relay, Setpoint 1 = 200

Output 2 = Relay, Setpoint 2 = 200

Alarm 1 Setup: Deviation, Band, "ALR.H" = 20

Alarm 2 Setup: Deviation, Hi/Low, "ALR.H" = 10, "ALR.L" = 5

Color Display Setup: "N.CLR" = Green, "1.CLR" = Amber, "2.CLR" = Red

Display colors change sequences:

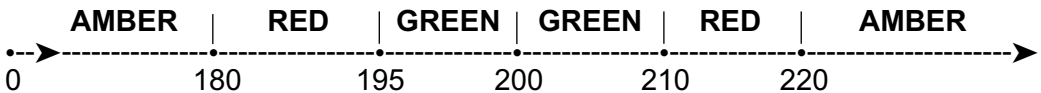

Note

Reset: The instrument automatically resets after the last menu of the Configuration Mode has been entered. After the instrument resets, it advances to the Run Mode.

PART 4 SPECIFICATIONS

Accuracy

±0.5°C temp; 0.03% reading process

Resolution

1°/0.1°; 10 µV process

Temperature Stability

1) RTD: 0.04°C/°C

2) TC @ 25°C (77°F): 0.05°C/°C

- Cold Junction Compensation

3) Process: 50 ppm/°C

NMRR

60 dB

CMRR

120 dB

A/D Conversion

Dual slope

Reading Rate

3 samples per second

Digital Filter

Programmable

Display

4-digit or 6-digit, 7-segment LED

57.2 mm (2.25") or 101.6mm (4.00")

red, green and amber programmable colors for process variable, set point and temperature units

Warm up to Rated Accuracy

60 min.

INPUT

Input Types

Thermocouple, RTD, Analog Voltage, Analog Current

Thermocouple Type (ITS 90)

J, K, T, E, R, S, B, C, N, L

Thermocouple Lead Resistance

100 ohm max

RTD Input (ITS 68)

100/500/1000 Ω Pt sensor, 2-, 3- or 4-wire; 0.00385 or 0.00392 curve

Voltage Input

0 to 100 mV, 0 to 1 V, 0 to 10 Vdc

Input Impedance

10 MΩ for 100 mV

1 MΩ for 1 or 10 Vdc

Current Input

0 to 20 mA (5 ohm load)

Configuration

Single-ended

Polarity

Unipolar

Step Response

0.7 sec for 99.9%

Decimal Selection

None, 0.1 for temperature

None, 0.1, 0.01 or 0.001 for process

Setpoint Adjustment

-1999 to 9999 counts

Span Adjustment

0.001 to 9999 counts

Offset Adjustment

-1999 to +9999

CONTROL

Action

Reverse (heat) or direct (cool)

Modes

Time and Amplitude Proportional Control Modes; selectable Manual or Auto PID, Proportional, Proportional with Integral, Proportional with Derivative with Anti-reset Windup and ON/OFF

Rate

0 to 399.9 seconds

Reset

0 to 3999 seconds

Cycle Time

1 to 199 seconds; set to 0 for ON/OFF operation

Gain

0.5 to 100% of span; Setpoints 1 or 2

Damping

0000 to 0008

Soak

00.00 to 99.59 (HH:MM), or OFF

Ramp to Setpoint

00.00 to 99.59 (HH:MM), or OFF

Auto Tune

Operator initiated from front panel

CONTROL OUTPUT 1 & 2

Relay

250 Vac or 30 Vdc @ 3 A
(Resistive Load); configurable for on/off, PID and Ramp and Soak

Output 1: SPDT type, can be configured as Alarm 1 output

Output 2: SPDT type, can be configured as Alarm 2 output

SSR

20-265 Vac @ 0.05-0.5 A
(Resistive Load); continuous

DC Pulse

Non-Isolated; 10 Vdc @ 20 mA

Analog Output (Output 1 only)

Non-Isolated, Proportional 0 to 10 Vdc or 0 to 20 mA; 500 Ω max

COMMUNICATIONS (optional)

RS-232 or RS-485 programmable

300 to 19.2 K baud; complete programmable setup capability; program to transmit current display, alarm status, Peak and Valley value.

RS-485

Addressable from 0 to 199

Connection

Screw terminals

ALARM 1 & 2 (programmable):

Type

Same as Output 1 & 2

Operation

High/low, above/below, band, latch/unlatch, normally open/normally closed and process/deviation; front panel configurations

ANALOG OUTPUT (programmable)

Non-Isolated, Retransmission 0 to 10 Vdc or 0 to 20 mA, 500 Ω max (Output 1 only). Accuracy is \pm 1% of FS when following conditions are satisfied.

- 1) Input is not scaled below 1% of Input FS.
- 2) Analog Output is not scaled below 3% of Output FS.

EXCITATION

(optional in place of Communication)

24 Vdc @ 25 mA

INSULATION

Power to Input/Output

2500 Vac per 1 minute test (RS-232/485, Input or Output)

Between Inputs

500 Vac per 1 minute test

Approvals

See CE Approval Section

GENERAL

Power

100-240 Vac +/-10%, 50/60 Hz
22.5 W

Fuse

4A, 250V, GFE, 5x20mm

Environmental Conditions

0 to 40°C (32 to 104°F),
90% RH non-condensing

Installation Category

II per EN61010-1

Equipment Class

I per EN61010-1

Pollution Degree

2 per EN61010-1

Protection

NEMA-4x (IP65) front bezel

Dimensions and Panel Cutout

Refer to Quickstart Specifications.

Weight

Refer to Quickstart Specifications.

Table 4.1 Input Properties

TC	Input Type	Range	Accuracy*
J	Iron-Constantan	-210 to 760°C -346 to 1400°F	0.4°C 0.7°F
K	CHROMEGA®- ALOMEGA®	-270 to -160°C -160 to 1372°C -454 to -256°F -256 to 2502°F	1.0°C 0.4°C 1.8°F 0.7°F
T	Copper-Constantan	-270 to -190°C -190 to 400°C -454 to -310°F -310 to 752°F	1.0°C 0.4°C 1.8°F 0.7°F
E	CHROMEGA- Constantan	-270 to -220°C -220 to 1000°C -454 to -364°F -364 to 1832°F	1.0°C 0.4°C 1.8°F 0.7°F
R	Pt/13%Rh-Pt	-50 to 40°C 40 to 1788°C -58 to 104°F 104 to 3250°F	1.0°C 0.5°C 1.8°F 0.9°F
S	Pt/10%Rh-Pt	-50 to 100°C 100 to 1768°C -58 to 212°F 212 to 3214°F	1.0°C 0.5°C 1.8°F 0.9°F
B	30%Rh-Pt/ 6%Rh-Pt	200 to 640°C 640 to 1820°C 212 to 1184°F 1184 to 3308°F	1.0°C 0.5°C 1.8°F 0.9°F
C	5%Re-W/ 26%Re-W	0 to 2354°C 32 to 4253°F	0.4°C 0.7°F
N	Nicrosil-Nisil	-250 to -100°C -100 to 1300°C -418 to -148°F -148 to 2372°F	1.0°C 0.4°C 1.8°F 0.7°F
L	J DIN	-200 to 900°C -328 to 1652°F	0.4°C 0.7°F
RTD	Pt, 0.00385, 100 Ω, 500 Ω, 1000 Ω	200 to 900°C -328 to 1652°F	0.4°C 0.7°F
RTD	Pt, 0.00392, 100 Ω, 500 Ω, 1000 Ω	-200 to 850°C -328 to 1562°F	0.4°C 0.7°F
PROCESS	Voltage	0 to 100 mV, 0 to 1 V, 0 to 10 Vdc	0.03% rdg 0.03% rdg
PROCESS	Current	0 to 20 mA, 4 to 20 mA	0.03% rdg

PART 5 FACTORY PRESET VALUES

Table 5.1 Factory preset value

MENU ITEMS	FACTORY PRESET VALUES	NOTES
Set Point 1 (SP1)	000.0	
Set Point 2 (SP2)	000.0	
Input:		
Input Type (INPT)	TC, type K	
Reading Configuration (RDG):		
Decimal Point (DEC.P)	FFF.F	
Temperature unit (TEMP)	°F	
Filter value (FLTR)	0004	
Alarm 1 & 2:		
Alarm 1 (ALR1), Alarm 2 (ALR2)	Disable (DSBL)	
Absolute/Deviation (ABS0/DEV)	Absolute (ABS0)	
Latch/Unlatch (LTCH/UNLT)	Unlatch (UNLT)	
Contact Closure (CT.CL)	Normally Open (N.O.)	
Active (ACTV)	Above (ABOV)	
Alarm At Power On (A.P.ON)	Disable (DSBL)	Alarm 1 only
Alarm Low (ALR.L)	-100.0	
Alarm High (ALR.H)	400.0	
LOOP:		
Loop Break Time (LOOP)	Disable (DSBL)	
Loop Value (B.TIM)	00:59	
Reading Adjust Value (R.ADJ)	000.0	
ANALOG OUTPUT (Retransmission):		
Analog Output (ANLG)	Enabled (ENBL)	
Current/Voltage (CURR/VOLT)	Voltage (VOLT)	
Scale and Offset	Reading: 0 - 999.9 cts, Output: 0 - 10 V	
OUTPUT 1 & 2:		
Self (SELF)	Disabled (DSBL)	Output 1 only
% Low Value (%LO)	0000	Output 1 only
% High Value (%HI)	0099	Output 1 only
Control Type (CTRL)	On/Off	
Action Type (ACTN)	Reverse (RVRS)	
Dead Band (DEAD)	020.0	
PID Auto (AUTO)	Disable (DSBL)	
Anti Integral (ANTI)	Disable (DSBL)	Output 1 only
Proportion Value (PROP)	020.0	
Reset Value (REST)	0180	Output 1 only
Rate Value (RATE)	0000	Output 1 only
Cycle Value (CYCL)	0007	
Damping Factor (DPNG)	0003	

MENU ITEMS	FACTORY PRESET VALUES	NOTES
Ramp & Soak (RAMP):		
Ramp (RAMP)	Disable (DSBL)	
Soak (SOAK)	Disable (DSBL)	
Ramp Value (RAMP)	00:00	
Soak Value (SOAK)	00:00	
ID:		
ID Value	0000	
Full ID (FULL)	Disable (DSBL)	
Set Point ID (ID.SP)	Disable (DSBL)	
Communication Parameters:		
Baud Rate (BAUD)	9600	
Parity (PRTY)	Odd	
Data bit (DATA)	7 bit	
Stop Bit	1 bit	
Modbus Protocol (M.BUS)	No	
Line Feed (LF)	No	
Echo (ECHO)	Yes	
Standard Interface (STND)	RS-232 (232C)	
Command Mode (MODE)	Command (CMD)	
Separation (SEPR)	Space (SPCE)	
Alarm Status (STAT)	No	
Reading (RDNG)	Yes	
Peak	No	
Valley (VALY)	No	
Units (UNIT)	No	
Multipoint Address (ADDR)	0001	
Transmit Time (TR.TM)	0016	
Display Color (COLR):		
Normal Color (N.CLR)	Green (GRN)	
Alarm 1 Color (1.CLR)	Red (RED)	
Alarm 2 Color (2.CLR)	Amber (AMBR)	

CE APPROVAL INFORMATION

1. Electromagnetic Compatibility (EMC)

This device conforms with requirements of EMC Directive 89/336/EEC, amended by 93/68/EEC. This instrument complies with the following EMC Immunity Standards as tested per EN 61326-2:1998 (Industrial Locations)

Phenomena	Test Specification	Basic Standard
Electrostatic Discharge	+/- 4 kV contact discharge +/- 8 kV air discharge	IEC 1000-4-2 Performance Criteria B
Radio Frequency electromagnetic field.	27 - 1000 MHz 3 V/m 80% AM (1 KHz)	IEC 1000-4-3 Performance Criteria A
Fast Transients	+/- 2 kV (ac mains) +/- 1 kV (dc, signal I/O) 5/50 ns Tr/Th, 5 KHz rep. freq.	IEC 1000-4-4 Performance Criteria B
Surge	+/- 1.0 kV AC Port L-L +/- 2.0 kV AC Port L-PE +/- 1.0 kV DC Port L-L +/- 2.0 kV DC Port L-PE	IEC 1000-4-5 Performance Criteria B
Radio Frequency conducted	0.15 - 80 MHz 3 Vrms 80% AM (1 KHz)	IEC 1000-4-6 Performance Criteria A

This instrument complies with the following EMC Emission Standards as tested per EN 61326-2:1998 (Class B equipment)

Phenomena	Frequency Range	Limits	Basic Standard
Radiated Emission	30-230 MHz 230-1000 MHz	30 dB_V/m at 10 m 37 dB_V/m at 10 m quasi peak	CISPR 22 Class B
Conducted Emission	0.15-0.5 MHz 0.5-5 MHz 5-30 MHz	66-56 dB_V quasi peak 56 dB_V quasi peak 60 dB_V quasi peak	CISPR 22 Class B

2. Safety

This device conforms with Low Voltage Directive 73/23/EEC, amended by 93/68/EEC. The following LVD requirements have been met to comply with EN 61010-1, 1993 (Electrical equipment for measurement, control and laboratory use)

1. Pollution Degree 2
2. Installation Category II
3. Class I Equipment (100-240 Vac Powered Units)



WARRANTY/DISCLAIMER

OMEGA ENGINEERING, INC. warrants this unit to be free of defects in materials and workmanship for a period of **one (1) year** from the date of purchase. In addition to OMEGA's standard warranty period, OMEGA Engineering will extend the warranty period for **four (4) additional years** if the warranty card enclosed with each instrument is returned to OMEGA.

If the unit should malfunction, it must be returned to the factory for evaluation. OMEGA's Customer Service Department will issue an Authorized Return (AR) number immediately upon phone or written request. Upon examination by OMEGA, if the unit is found to be defective, it will be repaired or replaced at no charge. OMEGA's WARRANTY does not apply to defects resulting from any action of the purchaser, including but not limited to mishandling, improper interfacing, operation outside of design limits, improper repair, or unauthorized modification. This WARRANTY is VOID if the unit shows evidence of having been tampered with or shows evidence of having been damaged as a result of excessive corrosion; or current, heat, moisture or vibration; improper specification; misapplication; misuse or other operating conditions outside of OMEGA's control. Components which wear are not warranted, including but not limited to contact points, fuses, and triacs.

OMEGA is pleased to offer suggestions on the use of its various products. However, OMEGA neither assumes responsibility for any omissions or errors nor assumes liability for any damages that result from the use of its products in accordance with information provided by OMEGA, either verbal or written. OMEGA warrants only that the parts manufactured by it will be as specified and free of defects. OMEGA MAKES NO OTHER WARRANTIES OR REPRESENTATIONS OF ANY KIND WHATSOEVER, EXPRESS OR IMPLIED, EXCEPT THAT OF TITLE, AND ALL IMPLIED WARRANTIES INCLUDING ANY WARRANTY OF MERCHANTABILITY AND FITNESS FOR A PARTICULAR PURPOSE ARE HEREBY DISCLAIMED. LIMITATION OF LIABILITY: The remedies of purchaser set forth herein are exclusive, and the total liability of OMEGA with respect to this order, whether based on contract, warranty, negligence, indemnification, strict liability or otherwise, shall not exceed the purchase price of the component upon which liability is based. In no event shall OMEGA be liable for consequential, incidental or special damages.

CONDITIONS: Equipment sold by OMEGA is not intended to be used, nor shall it be used: (1) as a "Basic Component" under 10 CFR 21 (NRC), used in or with any nuclear installation or activity; or (2) in medical applications or used on humans. Should any Product(s) be used in or with any nuclear installation or activity, medical application, used on humans, or misused in any way, OMEGA assumes no responsibility as set forth in our basic WARRANTY/DISCLAIMER language, and, additionally, purchaser will indemnify OMEGA and hold OMEGA harmless from any liability or damage whatsoever arising out of the use of the Product(s) in such a manner.

RETURN REQUESTS/INQUIRIES

Direct all warranty and repair requests/inquiries to the OMEGA Customer Service Department. BEFORE RETURNING ANY PRODUCT(S) TO OMEGA, PURCHASER MUST OBTAIN AN AUTHORIZED RETURN (AR) NUMBER FROM OMEGA'S CUSTOMER SERVICE DEPARTMENT (IN ORDER TO AVOID PROCESSING DELAYS). The assigned AR number should then be marked on the outside of the return package and on any correspondence.

The purchaser is responsible for shipping charges, freight, insurance and proper packaging to prevent breakage in transit.

FOR WARRANTY RETURNS, please have the following information available BEFORE contacting OMEGA:

1. Purchase Order number under which the product was PURCHASED,
2. Model and serial number of the product under warranty, and
3. Repair instructions and/or specific problems relative to the product.

FOR NON-WARRANTY REPAIRS, consult OMEGA for current repair charges. Have the following information available BEFORE contacting OMEGA:

1. Purchase Order number to cover the COST of the repair,
2. Model and serial number of product, and
3. Repair instructions and/or specific problems relative to the product.

OMEGA's policy is to make running changes, not model changes, whenever an improvement is possible. This affords our customers the latest in technology and engineering.

© Copyright 2004 OMEGA ENGINEERING, INC. All rights reserved. This document may not be copied, photocopied, reproduced, translated, or reduced to any electronic medium or machine-readable form, in whole or in part, without the prior written consent of OMEGA ENGINEERING, INC.

TRADEMARK NOTICE: ®, omega.com®,  OMEGA®, and  are Trademarks of OMEGA ENGINEERING, INC.

PATENT NOTICE: This product is covered by one or more of the following patents: U.S. Pat. No. Des. 336,895; 5,274,577; 6,243,021 / CANADA 2052599; 2052600 / ITALY 1249456; 1250938 / FRANCE BREVET No. 91 12756 / SPAIN 2039150; 2048066 / UK PATENT No. GB2 249 837; GB2 248 954 / GERMANY DE 41 34398 C2. Other US and International Patents pending or applied for.

Where Do I Find Everything I Need for Process Measurement and Control? **OMEGA...Of Course!** *Shop on line at www.omega.com*

TEMPERATURE

- Thermocouple, RTD & Thermistor Probes, Connectors, Panels & Assemblies
- Wire: Thermocouple, RTD & Thermistor
- Calibrators & Ice Point References
- Recorders, Controllers & Process Monitors
- Infrared Pyrometers

PRESSURE, STRAIN AND FORCE

- Transducers & Strain Gauges
- Load Cells & Pressure Gauges
- Displacement Transducers
- Instrumentation & Accessories

FLOW/LEVEL

- Rotameters, Gas Mass Flowmeters & Flow Computers
- Air Velocity Indicators
- Turbine/Paddlewheel Systems
- Totalizers & Batch Controllers

pH/CONDUCTIVITY

- pH Electrodes, Testers & Accessories
- Benchtop/Laboratory Meters
- Controllers, Calibrators, Simulators & Pumps
- Industrial pH & Conductivity Equipment

DATA ACQUISITION

- Data Acquisition & Engineering Software
- Communications-Based Acquisition Systems
- Plug-in Cards for Apple, IBM & Compatibles
- Datalogging Systems
- Recorders, Printers & Plotters

HEATERS

- Heating Cable
- Cartridge & Strip Heaters
- Immersion & Band Heaters
- Flexible Heaters
- Laboratory Heaters

ENVIRONMENTAL MONITORING AND CONTROL

- Metering & Control Instrumentation
- Refractometers
- Pumps & Tubing
- Air, Soil & Water Monitors
- Industrial Water & Wastewater Treatment
- pH, Conductivity & Dissolved Oxygen Instruments